

FGA25N120AND

General Description

Employing NPT technology, Fairchild's AND series of IGBTs provides low conduction and switching losses. The AND series offers an solution for application such as induction heating (IH), motor control, general purpose inverters and uninterruptible power supplies (UPS).

Features

- High speed switching
- Low saturation voltage : $V_{CE(sat)} = 2.5\text{ V @ } I_C = 25\text{ A}$
- High input impedance
- CO-PAK, IGBT with FRD : $t_{rr} = 235\text{ ns (typ.)}$

Applications

Induction Heating, UPS, AC & DC motor controls and general purpose inverters.

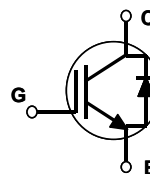
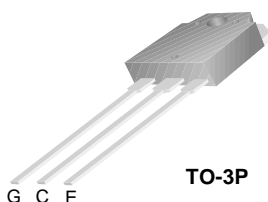

Absolute Maximum Ratings $T_C = 25^\circ\text{C}$ unless otherwise noted

Symbol	Description	FGA25N120AND	Units
V_{CES}	Collector-Emitter Voltage	1200	V
V_{GES}	Gate-Emitter Voltage	± 20	V
I_C	Collector Current @ $T_C = 25^\circ\text{C}$	40	A
	Collector Current @ $T_C = 100^\circ\text{C}$	25	A
$I_{CM(1)}$	Pulsed Collector Current	75	A
I_F	Diode Continuous Forward Current @ $T_C = 100^\circ\text{C}$	25	A
I_{FM}	Diode Maximum Forward Current	150	A
P_D	Maximum Power Dissipation @ $T_C = 25^\circ\text{C}$	310	W
	Maximum Power Dissipation @ $T_C = 100^\circ\text{C}$	125	W
T_J	Operating Junction Temperature	-55 to +150	$^\circ\text{C}$
T_{stg}	Storage Temperature Range	-55 to +150	$^\circ\text{C}$
T_L	Maximum Lead Temp. for soldering Purposes, 1/8" from case for 5 seconds	300	$^\circ\text{C}$

Notes :

(1) Repetitive rating : Pulse width limited by max. junction temperature

Thermal Characteristics

Symbol	Parameter	Typ.	Max.	Units
$R_{\theta JC}$ (IGBT)	Thermal Resistance, Junction-to-Case	--	0.4	$^\circ\text{C/W}$
$R_{\theta JC}$ (DIODE)	Thermal Resistance, Junction-to-Case	--	2.0	$^\circ\text{C/W}$
$R_{\theta JA}$	Thermal Resistance, Junction-to-Ambient	--	40	$^\circ\text{C/W}$

Electrical Characteristics of the IGBT T_C = 25°C unless otherwise noted

Symbol	Parameter	Test Conditions	Min.	Typ.	Max.	Units
Off Characteristics						
BV _{CES}	Collector-Emitter Breakdown Voltage	V _{GE} = 0V, I _C = 3mA	1200	--	--	V
ΔBV _{CES} /ΔT _J	Temperature Coefficient of Breakdown Voltage	V _{GE} = 0V, I _C = 3mA	--	0.6	--	V/°C
I _{CES}	Collector Cut-Off Current	V _{CE} = V _{CES} , V _{GE} = 0V	--	--	3	mA
I _{GES}	G-E Leakage Current	V _{GE} = V _{GES} , V _{CE} = 0V	--	--	± 100	nA

On Characteristics

V _{GE(th)}	G-E Threshold Voltage	I _C = 25mA, V _{CE} = V _{GE}	3.5	5.5	7.5	V
V _{CE(sat)}	Collector to Emitter Saturation Voltage	I _C = 25A, V _{GE} = 15V	--	2.5	3.2	V
		I _C = 25A, V _{GE} = 15V, T _C = 125°C	--	2.9	--	V
		I _C = 40A, V _{GE} = 15V	--	3.1	--	V

Dynamic Characteristics

C _{ies}	Input Capacitance	V _{CE} = 30V, V _{GE} = 0V, f = 1MHz	--	2100	--	pF
C _{oes}	Output Capacitance		--	180	--	pF
C _{res}	Reverse Transfer Capacitance		--	90	--	pF

Switching Characteristics

t _{d(on)}	Turn-On Delay Time	V _{CC} = 600 V, I _C = 25A, R _G = 10Ω, V _{GE} = 15V, Inductive Load, T _C = 25°C	--	60	--	ns
t _r	Rise Time		--	60	--	ns
t _{d(off)}	Turn-Off Delay Time		--	170	--	ns
t _f	Fall Time		--	45	90	ns
E _{on}	Turn-On Switching Loss		--	4.8	7.2	mJ
E _{off}	Turn-Off Switching Loss		--	1.0	1.5	mJ
E _{ts}	Total Switching Loss		--	5.7	8.7	mJ
t _{d(on)}	Turn-On Delay Time	V _{CC} = 600 V, I _C = 25A, R _G = 10Ω, V _{GE} = 15V, Inductive Load, T _C = 125°C	--	60	--	ns
t _r	Rise Time		--	60	--	ns
t _{d(off)}	Turn-Off Delay Time		--	180	--	ns
t _f	Fall Time		--	70	--	ns
E _{on}	Turn-On Switching Loss		--	5.5	--	mJ
E _{off}	Turn-Off Switching Loss		--	1.4	--	mJ
E _{ts}	Total Switching Loss		--	6.9	--	mJ
Q _g	Total Gate Charge	V _{CE} = 600 V, I _C = 25A, V _{GE} = 15V	--	200	300	nC
Q _{ge}	Gate-Emitter Charge		--	15	23	nC
Q _{gc}	Gate-Collector Charge		--	105	160	nC
L _e	Internal Emitter Inductance	Measured 5mm from PKG	--	14	--	nH

Electrical Characteristics of DIODE T_C = 25°C unless otherwise noted

Symbol	Parameter	Test Conditions	Min.	Typ.	Max.	Units	
V _{FM}	Diode Forward Voltage	I _F = 25A	T _C = 25°C	--	2.0	3.0	V
			T _C = 125°C	--	2.1	--	
t _{rr}	Diode Reverse Recovery Time	I _F = 25A	T _C = 25°C	--	235	350	ns
			T _C = 125°C	--	300	--	
I _{rr}	Diode Peak Reverse Recovery Current	dI/dt = 200 A/μs	T _C = 25°C	--	27	40	A
			T _C = 125°C	--	31	--	
Q _{rr}	Diode Reverse Recovery Charge	I _F = 25A	T _C = 25°C	--	3130	4700	nC
			T _C = 125°C	--	4650	--	

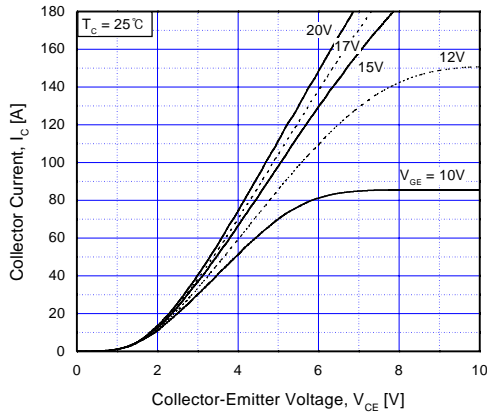

Fig 1. Typical Output Characteristics

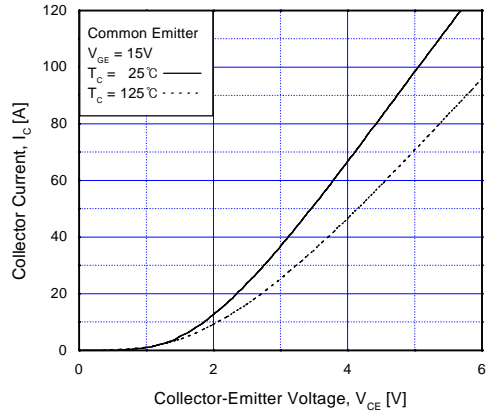

Fig 2. Typical Saturation Voltage Characteristics

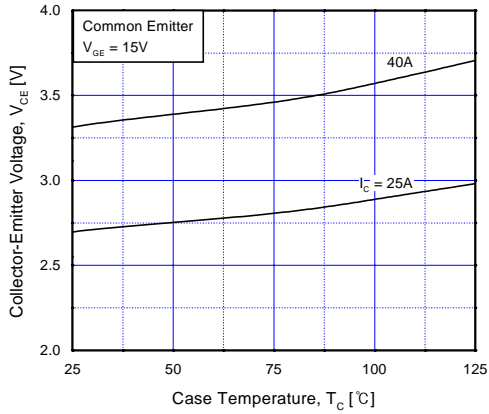

Fig 3. Saturation Voltage vs. Case Temperature at Variant Current Level

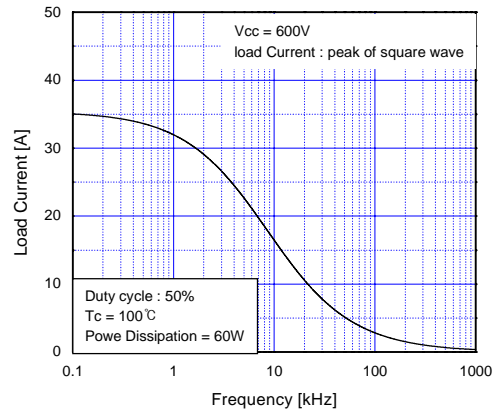

Fig 4. Load Current vs. Frequency

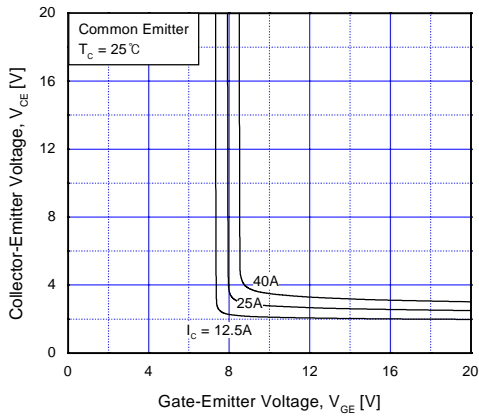

Fig 5. Saturation Voltage vs. V_{GE}

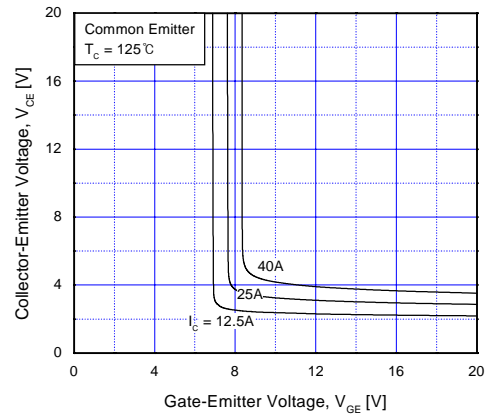

Fig 6. Saturation Voltage vs. V_{GE}

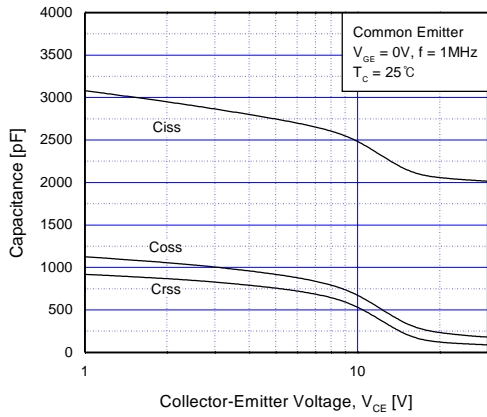

Fig 7. Capacitance Characteristics

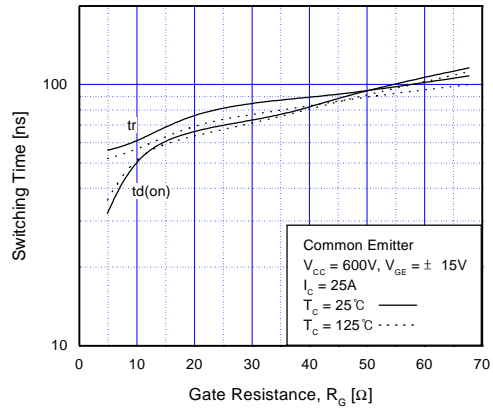

Fig 8. Turn-On Characteristics vs. Gate Resistance

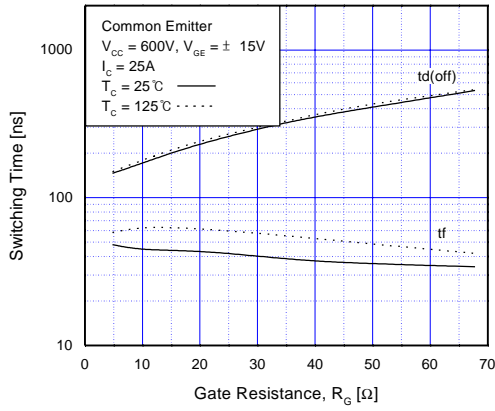

Fig 9. Turn-Off Characteristics vs. Gate Resistance

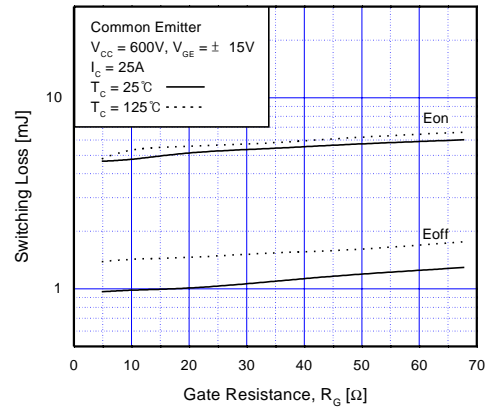

Fig 10. Switching Loss vs. Gate Resistance

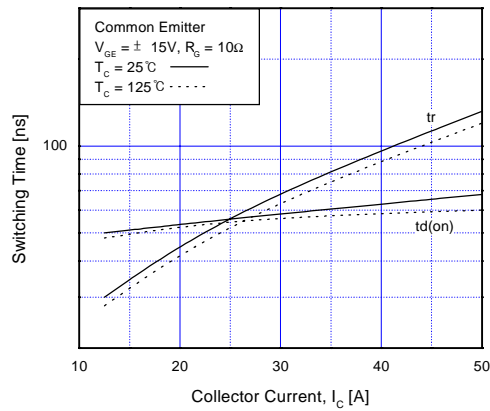

Fig 11. Turn-On Characteristics vs. Collector Current

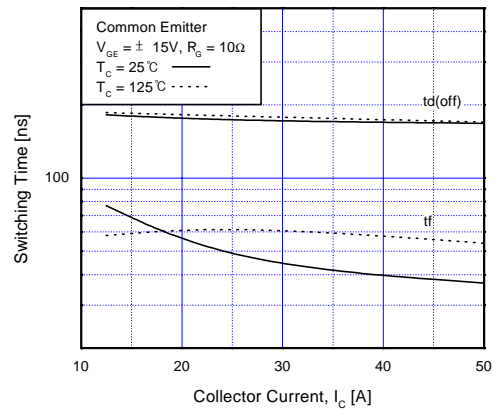

Fig 12. Turn-Off Characteristics vs. Collector Current

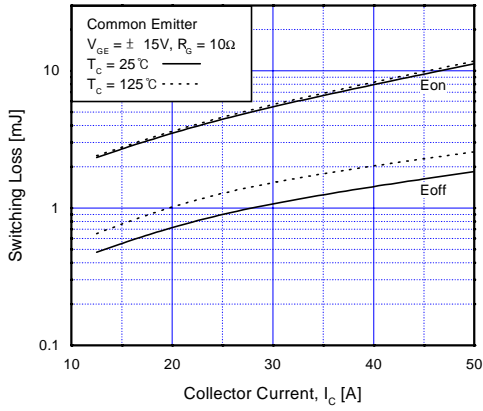

Fig 13. Switching Loss vs. Collector Current

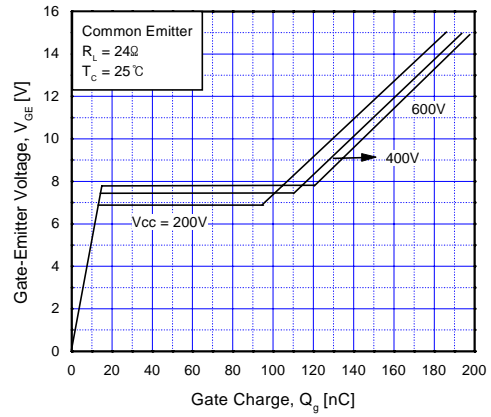

Fig 14. Gate Charge Characteristics

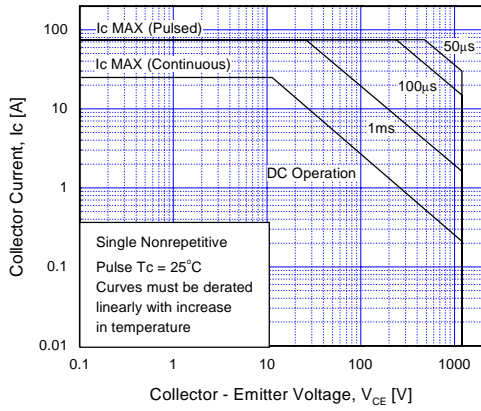

Fig 15. SOA Characteristics

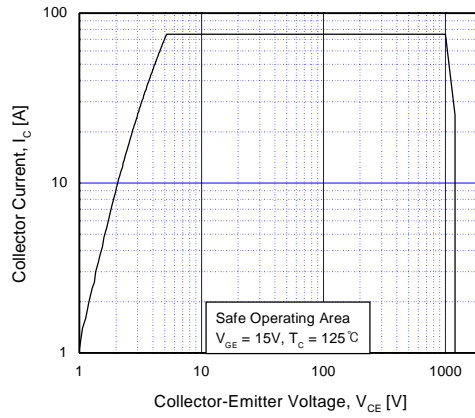

Fig 16. Turn-Off SOA

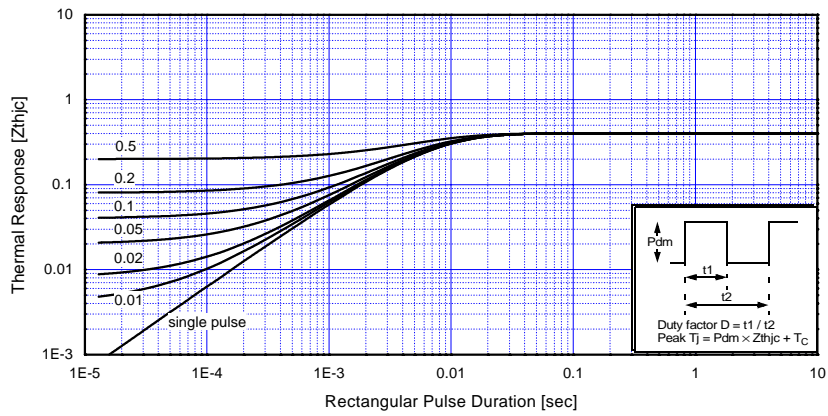

Fig 17. Transient Thermal Impedance of IGBT

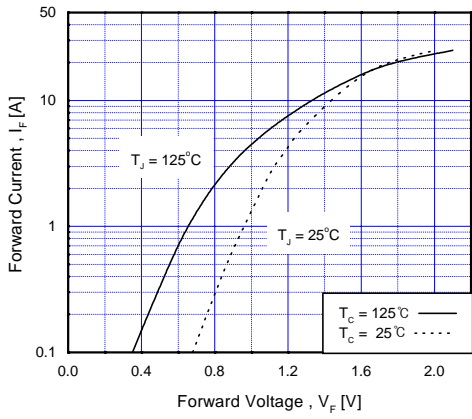

Fig 18. Forward Characteristics

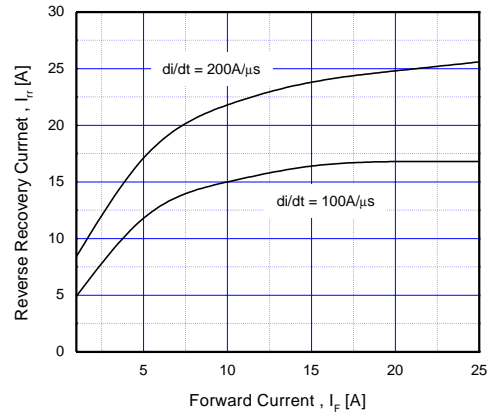

Fig 19. Reverse Recovery Current

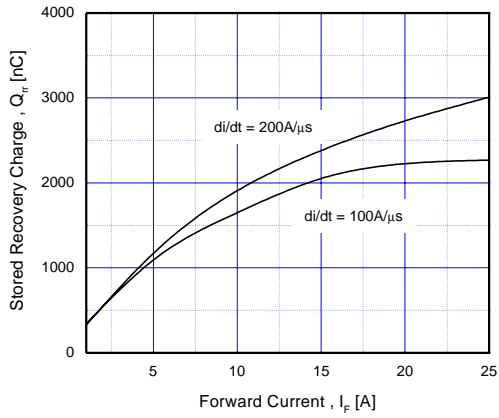

Fig 20. Stored Charge

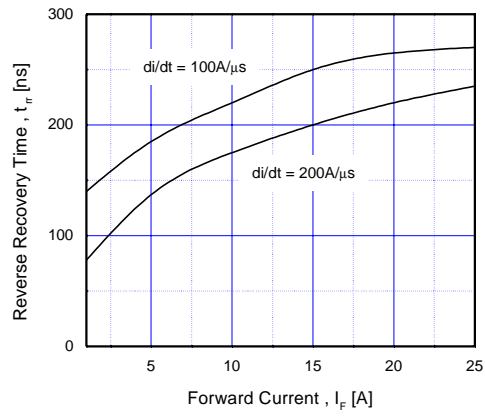
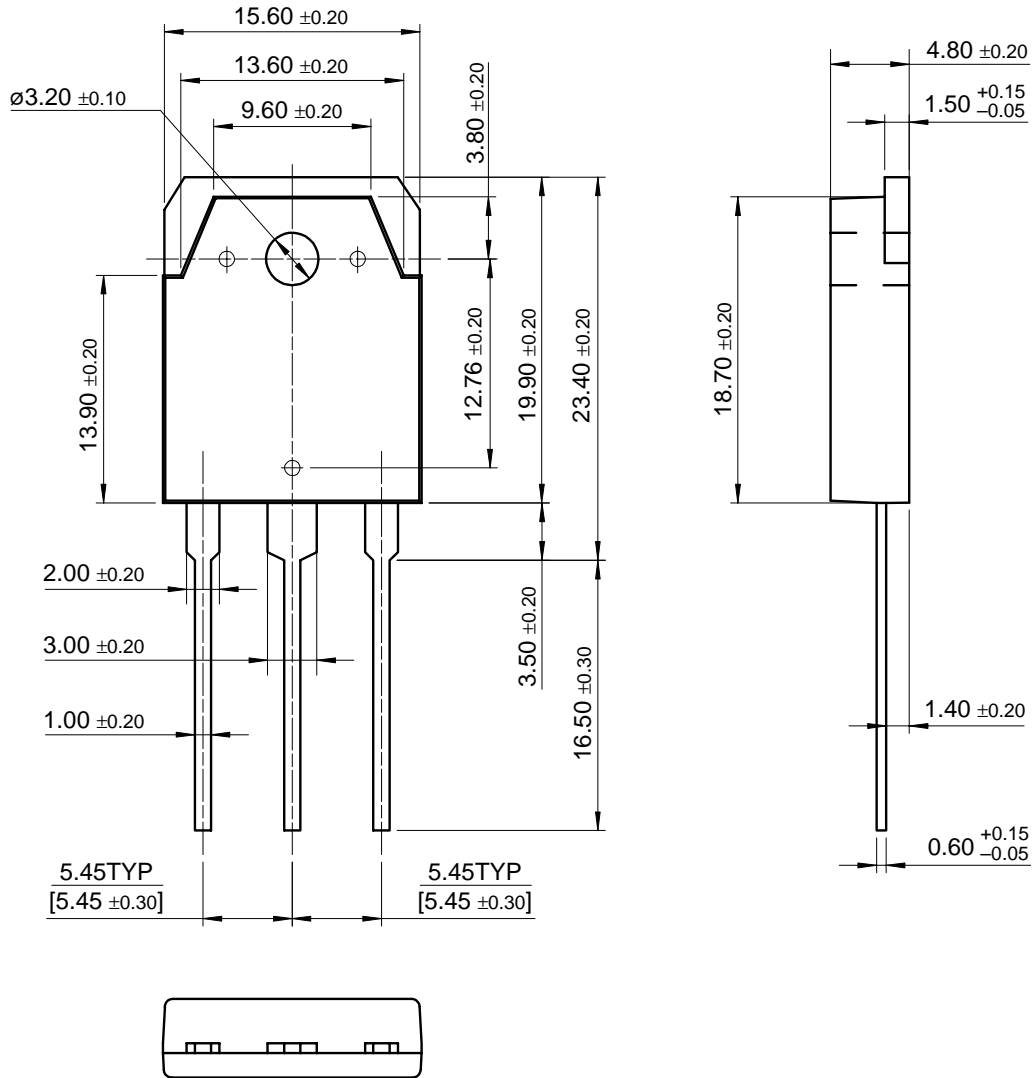

Fig 21. Reverse Recovery Time

Package Dimension

TO-3P



FGA25N120AND

Dimensions in Millimeters

TRADEMARKS

The following are registered and unregistered trademarks Fairchild Semiconductor owns or is authorized to use and is not intended to be an exhaustive list of all such trademarks.

ACE ^x TM	FACT TM	ImpliedDisconnect TM	PACMAN TM	SPM TM
ActiveArray TM	FACT Quiet series TM	ISOPLANAR TM	POP TM	Stealth TM
Bottomless TM	FAST [®]	LittleFET TM	Power247 TM	SuperSOT TM -3
CoolFET TM	FAST ^r TM	MicroFET TM	PowerTrench [®]	SuperSOT TM -6
CROSSVOLT TM	FRFET TM	MicroPak TM	QFET TM	SuperSOT TM -8
DOME TM	GlobalOptoisolator TM	MICROWIRE TM	QS TM	SyncFET TM
EcoSPARK TM	GTO TM	MSX TM	QT Optoelectronics TM	TinyLogic [®]
E ² CMOS TM	HiSeC TM	MSXPro TM	Quiet Series TM	TruTranslation TM
EnSigna TM	I ² C TM	OCX TM	RapidConfigure TM	UHC TM
Across the board. Around the world. TM		OCXPro TM	RapidConnect TM	UltraFET [®]
The Power Franchise TM		OPTOLOGIC [®]	SILENT SWITCHER [®]	VCX TM
Programmable Active Droop TM		OPTOPLANAR TM	SMART START TM	

DISCLAIMER

FAIRCHILD SEMICONDUCTOR RESERVES THE RIGHT TO MAKE CHANGES WITHOUT FURTHER NOTICE TO ANY PRODUCTS HEREIN TO IMPROVE RELIABILITY, FUNCTION OR DESIGN. FAIRCHILD DOES NOT ASSUME ANY LIABILITY ARISING OUT OF THE APPLICATION OR USE OF ANY PRODUCT OR CIRCUIT DESCRIBED HEREIN; NEITHER DOES IT CONVEY ANY LICENSE UNDER ITS PATENT RIGHTS, NOR THE RIGHTS OF OTHERS.

LIFE SUPPORT POLICY

FAIRCHILD'S PRODUCTS ARE NOT AUTHORIZED FOR USE AS CRITICAL COMPONENTS IN LIFE SUPPORT DEVICES OR SYSTEMS WITHOUT THE EXPRESS WRITTEN APPROVAL OF FAIRCHILD SEMICONDUCTOR INTERNATIONAL.

As used herein:

1. Life support devices or systems are devices or systems which, (a) are intended for surgical implant into the body, or (b) support or sustain life, or (c) whose failure to perform when properly used in accordance with instructions for use provided in the labeling, can be reasonably expected to result in significant injury to the user.
2. A critical component is any component of a life support device or system whose failure to perform can be reasonably expected to cause the failure of the life support device or system, or to affect its safety or effectiveness.



PRODUCT STATUS DEFINITIONS

Definition of Terms

Datasheet Identification	Product Status	Definition
Advance Information	Formative or In Design	This datasheet contains the design specifications for product development. Specifications may change in any manner without notice.
Preliminary	First Production	This datasheet contains preliminary data, and supplementary data will be published at a later date. Fairchild Semiconductor reserves the right to make changes at any time without notice in order to improve design.
No Identification Needed	Full Production	This datasheet contains final specifications. Fairchild Semiconductor reserves the right to make changes at any time without notice in order to improve design.
Obsolete	Not In Production	This datasheet contains specifications on a product that has been discontinued by Fairchild semiconductor. The datasheet is printed for reference information only.

Looking for pricing, stock, or lifecycle information?

Click below to explore more details on WIN SOURCE:

-  [View FGA25N120ANDTU on WIN SOURCE](#)
-  [Fairchild/ON Semiconductor Information](#)

Optimize Your Supply Chain with WIN SOURCE Solutions

-  Global Sourcing Solution
-  Obsolete Management
-  Cost Control Management
-  Shortage Management
-  Alternative Solution
-  Excess Inventory Management