



**THE DATASHEET OF  
F980J475MUA**



# F98 Series



## Resin-Molded Chip, High CV Undertab



### FEATURES

- Compliant to the RoHS2 directive 2011/65/EU
- SMD face down design
- Small and low profile



### APPLICATIONS

- Smartphone
- Mobile phone
- Wireless module
- Hearing aid

### CASE DIMENSIONS: millimeters (inches)

Code	EIA Code	EIA Metric	L	W <sub>1</sub>	W <sub>2</sub>	H	S <sub>1</sub>	S <sub>2</sub>
<b>M</b>	0603	1608-09	1.60 <sup>+0.20</sup> <sub>-0.10</sub> (0.063 <sup>+0.008</sup> <sub>-0.004</sub> )	0.85 <sup>+0.20</sup> <sub>-0.10</sub> (0.033 <sup>+0.008</sup> <sub>-0.004</sub> )	0.65±0.10 (0.026±0.004)	0.80±0.10 <sup>*3</sup> (0.031±0.004)	0.50±0.10 (0.020±0.004)	0.60±0.10 (0.024±0.004)
<b>S</b>	0805	2012-09	2.00 <sup>+0.20</sup> <sub>-0.10</sub> (0.079 <sup>+0.008</sup> <sub>-0.004</sub> )	1.25 <sup>+0.20</sup> <sub>-0.10</sub> (0.049 <sup>+0.008</sup> <sub>-0.004</sub> )	0.90±0.10 (0.035±0.004)	0.80±0.10 (0.031±0.004)	0.50±0.10 (0.020±0.004)	1.00±0.10 (0.039±0.004)
<b>U</b>	0402	1106-06	1.10±0.05 (0.043±0.002)	0.60±0.05 (0.024±0.002)	0.35±0.05 (0.014±0.002)	0.55±0.05 (0.022±0.002)	0.30±0.05 (0.012±0.002)	0.50±0.05 (0.020±0.002)

\*3 F980J107MMAAXE: 1.0mm Max.

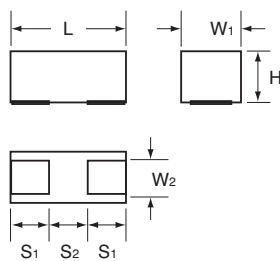

### MARKING

#### U CASE



#### M CASE

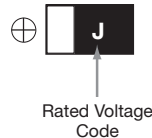

#### S CASE

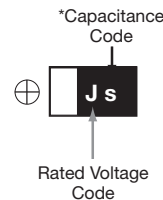

### HOW TO ORDER

**F98**

Type

**0J**

Rated Voltage

**106**

Capacitance Code

pF code: 1st two digits represent significant figures, 3rd digit represents multiplier (number of zeros to follow)

**M**

Tolerance  
M = ±20%

**M**

Case Size  
See table above

**□**

Packaging  
See Tape & Reel Packaging Section

**□□□**

Specification Suffix  
LZT = Rated temperature 60°C only  
AXE = Rated temperature 60°C and H dimension 1.0mm Max

### TECHNICAL SPECIFICATIONS

Category Temperature Range:	-55 to +125°C
Rated Temperature:	+85°C
Capacitance Tolerance:	±20% at 120Hz
Dissipation Factor:	Refer to next page
ESR 100kHz:	Refer to next page
Leakage Current:	Refer to next page Provided that: After 5 minute's application of rated voltage, leakage current at 85°C 10 times or less than 20°C specified value. After 5 minute's application of rated voltage, leakage current at 125°C 12.5 times or less than 20°C specified value.

# F98 Series



## Resin-Molded Chip, High CV Undertab

### CAPACITANCE AND RATED VOLTAGE RANGE (LETTER DENOTES CASE SIZE)

Capacitance		Rated Voltage								*Cap Code
µF	Code	2.5 (0e)	4V (0G)	6.3V (0J)	10V (1A)	16V (1C)	20V (1D)	25V (1E)	35V (1V)	
0.47	474					U				N
1.0	105					M	M	M	S	A
2.2	225				M/U	M				J
4.7	475		U	M/U	M/U**	M				S
10	106		U	M/U**	M	S				a
15	156		U							e
22	226		M/U**	M	M**/S					J
33	336		M	M	M**/S					n
47	476	M	M	M/S	S					s
68	686		M/S							w
100	107		M/S	M*/S						A
220	227		S							J

### RATINGS & PART NUMBER REFERENCE

AVX Part No.	Case Size	Capacitance (µF)	Rated Voltage (V)	DCL (µA)	DF @ 120Hz (%)	ESR @ 100kHz (Ω)	100kHz RMS Current (mA)				*1 ΔC/C (%)	MSL
							25°C	60°C	85°C	125°C		
<b>2.5 Volt</b>												
F980E476MMA	M	47	2.5	1.2	30	4	79	–	71	32	±30	3
<b>4 Volt</b>												
F980G475MUA	U	4.7	4	0.5	20	20	27	–	25	11	±30	3
F980G106MUA	U	10	4	0.8	25	20	27	–	25	11	±30	3
F980G156MUA	U	15	4	9.0	40	25	24	–	22	10	±30	3
F980G226MMA	M	22	4	0.9	15	7.5	58	–	52	23	±30	3
F980G226MUALZT	U	22	4	25.0	40	20	27	25	–	11	±30	3
F980G336MMA	M	33	4	1.3	30	4	79	–	71	32	±30	3
F980G476MMA	M	47	4	1.9	40	8	56	–	50	22	±30	3
F980G686MMA	M	68	4	27.2	50	10	50	–	45	20	±30	3
F980G686MSA	S	68	4	2.7	30	4	106	–	95	42	±30	3
F980G107MMA	M	100	4	80.0	60	10	50	–	45	20	±30	3
F980G107MSA	S	100	4	4.0	35	4	106	–	95	42	±30	3
F980G227MSA	S	220	4	132	80	5	95	–	85	38	±30	3
<b>6.3 Volt</b>												
F980J475MMA	M	4.7	6.3	0.5	20	7.5	58	–	52	23	±30	3
F980J475MUA	U	4.7	6.3	0.6	20	20	27	–	25	11	±30	3
F980J106MMA	M	10	6.3	0.6	8	6	65	–	58	26	±30	3
F980J106MUALZT	U	10	6.3	6.3	30	30	22	20	–	9	±30	3
F980J226MMA	M	22	6.3	1.4	20	6	65	–	58	26	±30	3
F980J336MMA	M	33	6.3	4.2	35	8	56	–	50	22	±30	3
F980J476MMA	M	47	6.3	29.6	45	10	50	–	45	20	±30	3
F980J476MSA	S	47	6.3	3.0	25	6	87	–	78	35	±30	3
F980J107MMAAXE	M	100	6.3	126	80	10	50	45	–	20	±30	3
F980J107MSA	S	100	6.3	63.0	50	8	75	–	68	30	±30	3
<b>10 Volt</b>												
F981A225MMA	M	2.2	10	0.5	6	7.5	58	–	52	23	±30	3
F981A225MUA	U	2.2	10	0.5	15	15	32	–	28	13	±30	3
F981A475MMA	M	4.7	10	0.5	6	6	65	–	58	26	±30	3
F981A475MUALZT	U	4.7	10	4.7	25	25	24	22	–	10	±30	3
F981A106MMA	M	10	10	1.0	20	7.5	58	–	52	23	±30	3
F981A226MMALZT	M	22	10	11.0	30	8	56	50	–	22	±30	3
F981A226MSA	S	22	10	2.2	20	4	106	–	95	42	±30	3
F981A336MMALZT	M	33	10	33.0	45	8	56	50	–	22	±30	3
F981A336MSA	S	33	10	3.3	30	6	87	–	78	35	±30	3
F981A476MSA	S	47	10	9.4	35	5	95	–	85	38	±30	3
<b>16 Volt</b>												
F981C474MUA	U	0.47	16	0.5	6	25	24	–	22	10	±20	3
F981C105MMA	M	1	16	0.5	6	10	50	–	45	20	±30	3
F981C225MMA	M	2.2	16	0.5	6	10	50	–	45	20	±30	3
F981C475MMA	M	4.7	16	0.8	12	12	46	–	41	18	±30	3
F981C106MSA	S	10	16	1.6	18	4	106	–	95	42	±30	3
<b>20 Volt</b>												
F981D105MMA	M	1	20	0.5	6	10	50	–	45	20	±30	3
<b>25 Volt</b>												
F981E105MMA	M	1	25	0.5	8	10	50	–	45	20	±30	3
<b>35 Volt</b>												
F981V105MSA	S	1	35	0.7	20	8	75	–	68	30	±30	3

\*2: Leakage Current

After 5 minute's application of rated voltage, leakage current at 20°C.

Moisture Sensitivity Level (MSL) is defined according to J-STD-020.

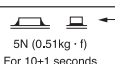
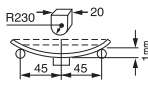

### QUALIFICATION TABLE

TEST	F98 series (Temperature range -55°C to +125°C)	
	Condition	
<b>Damp Heat (Steady State)</b>	At 40°C, 90 to 95% R.H., 500 hours (No voltage applied) Capacitance Change ..... Refer to page 60 (*1) Dissipation Factor ..... 150% or less of initial specified value Leakage Current ..... 200% or less of initial specified value	
<b>Temperature Cycles</b>	-55°C / +125°C, 30 minutes each, 5 cycles Capacitance Change ..... Refer to page 60 (*1) Dissipation Factor ..... 150% or less of initial specified value Leakage Current ..... 200% or less of initial specified value	
<b>Resistance to Soldering Heat</b>	10 seconds reflow at 260°C, 5 seconds immersion at 260°C. Capacitance Change ..... Refer to page 60 (*1) Dissipation Factor ..... Initial specified value or less Leakage Current ..... Initial specified value or less	
<b>Surge</b>	After application of surge in series with a 1kΩ resistor at the rate of 30 seconds ON, 30 seconds OFF, for 1000 successive test cycles at 85°C, capacitors shall meet the characteristic requirements in the table above. Capacitance Change ..... Refer to page 60 (*1) Dissipation Factor ..... 150% or less of initial specified value Leakage Current ..... 200% or less of initial specified value	
<b>Endurance</b>	After 1000 hours' application of rated voltage in series with a 3Ω resistor at 85°C, capacitors shall meet the characteristic requirements in the table above. Capacitance Change ..... Refer to page 60 (*1) Dissipation Factor ..... 150% or less of initial specified value Leakage Current ..... 200% or less of initial specified value	
<b>Shear Test</b>	After applying the pressure load of 5N for 10±1 seconds horizontally to the center of capacitor side body which has no electrode and has been soldered beforehand on a substrate, there shall be found neither exfoliation nor its sign at the terminal electrode.	
<b>Terminal Strength</b>	Keeping a capacitor surface-mounted on a substrate upside down and supporting the substrate at both of the opposite bottom points 45mm apart from the center of capacitor, the pressure strength is applied with a specified jig at the center of substrate so that the substrate may bend by 1mm as illustrated. Then, there shall be found no remarkable abnormality on the capacitor terminals.	

### AVX SOLID ELECTROLYTE CAPACITOR ROADMAP

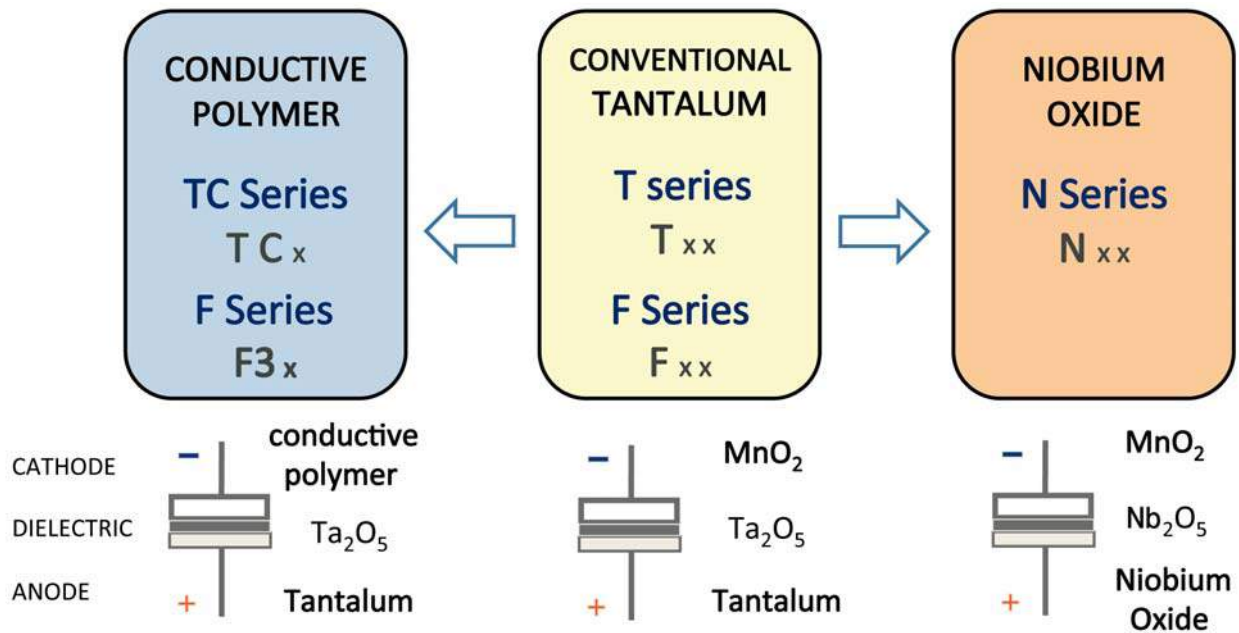

### Five Capacitor Construction Styles

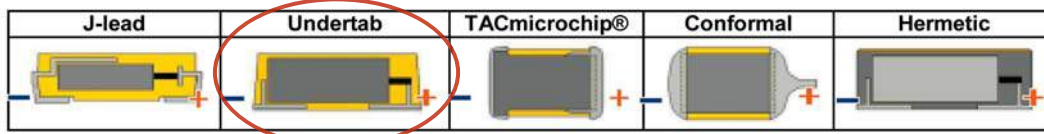

### SERIES LINE UP: CONVENTIONAL SMD MnO<sub>2</sub>

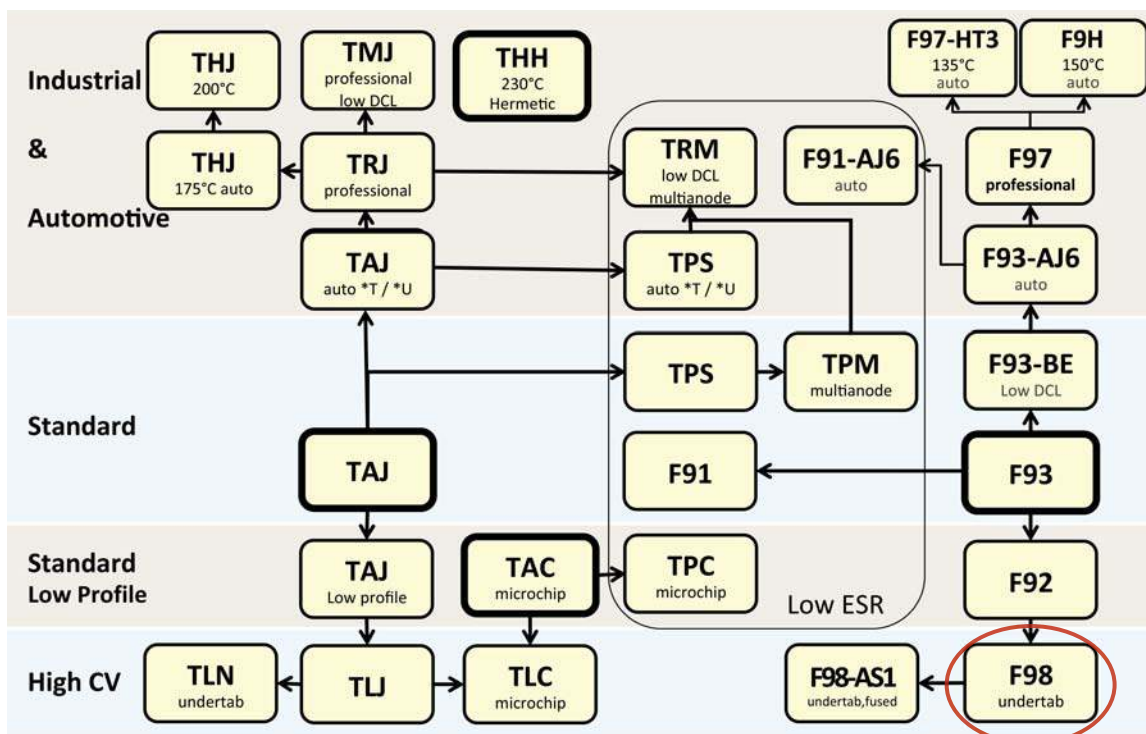

## Looking for pricing, stock, or lifecycle information?

Click below to explore more details on WIN SOURCE:

 [View F980J475MUA](#) on WIN SOURCE

 [AVX Corporation](#) Information

## Optimize Your Supply Chain with WIN SOURCE Solutions

-  Global Sourcing Solution
-  Obsolete Management
-  Cost Control Management
-  Shortage Management
-  Alternative Solution
-  Excess Inventory Management