



**THE DATASHEET OF
F920J226MBA**



F92 Series



Resin-Molded Chip, Low Profile J-Lead



FEATURES

- Compliant to the RoHS2 directive 2011/65/EU
- SMD J-lead
- Low profile case sizes

APPLICATIONS

- Handheld electronics
- USB accessories



CASE DIMENSIONS: millimeters (inches)

Code	EIA Code	EIA Metric	L	W ₁	W ₂	H	S
A	1206	3216-12	3.20 ± 0.20 (0.126 ± 0.008)	1.60 ± 0.20 (0.063 ± 0.008)	1.20 ± 0.10 (0.047 ± 0.004)	1.10 ± 0.10 (0.043 ± 0.004)	0.80 ± 0.20 (0.031 ± 0.008)
B	1311	3428-12	3.40 ± 0.20 (0.134 ± 0.008)	2.80 ± 0.20 (0.110 ± 0.008)	2.30 ± 0.10 (0.091 ± 0.004)	1.10 ± 0.10 (0.043 ± 0.004)	0.80 ± 0.20 (0.031 ± 0.008)
P	0805	2012-12	2.00 ± 0.20 (0.079 ± 0.008)	1.25 ± 0.10 (0.049 ± 0.004)	0.90 ± 0.10 (0.035 ± 0.004)	1.10 ± 0.10 (0.043 ± 0.004)	0.50 ± 0.20 (0.020 ± 0.008)

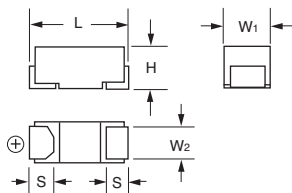

MARKING

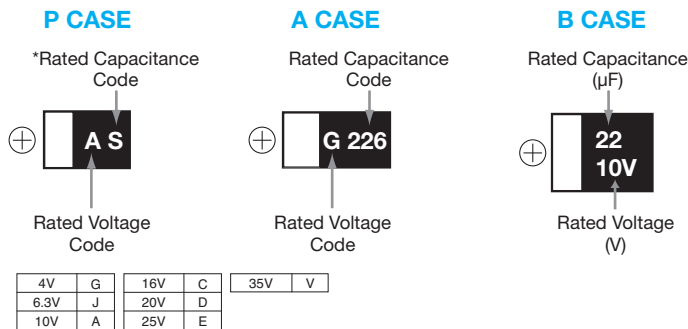

*Capacitance code of "P" case products are as shown below.

HOW TO ORDER

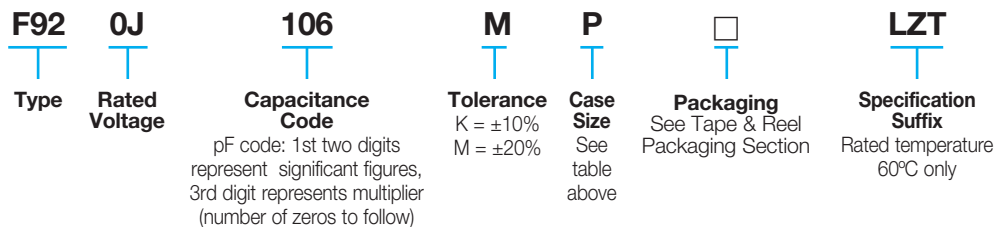

TECHNICAL SPECIFICATIONS

Category Temperature Range:	-55 to +125°C								
Rated Temperature:	+85°C								
Capacitance Tolerance:	±20%, ±10% at 120Hz								
Dissipation Factor:	Refer to next page								
ESR 100kHz:	Refer to next page								
Leakage Current:	After 1 minute's application of rated voltage, leakage current at 20°C is not more than 0.01CV or 0.5µA, whichever is greater. After 1 minute's application of rated voltage, leakage current at 85°C is not more than 0.1CV or 5µA, whichever is greater. After 1 minute's application of derated voltage, leakage current at 125°C is not more than 0.125CV or 6.3µA, whichever is greater.								
Capacitance Change By Temperature	<table border="1"> <thead> <tr> <th>P Case</th> <th>A, B Case</th> </tr> </thead> <tbody> <tr> <td>+20% Max. at +125°C</td> <td>+15% Max. at +125°C</td> </tr> <tr> <td>+15% Max. at +85°C</td> <td>+10% Max. at +85°C</td> </tr> <tr> <td>-15% Max. at -55°C</td> <td>-10% Max. at -55°C</td> </tr> </tbody> </table>	P Case	A, B Case	+20% Max. at +125°C	+15% Max. at +125°C	+15% Max. at +85°C	+10% Max. at +85°C	-15% Max. at -55°C	-10% Max. at -55°C
P Case	A, B Case								
+20% Max. at +125°C	+15% Max. at +125°C								
+15% Max. at +85°C	+10% Max. at +85°C								
-15% Max. at -55°C	-10% Max. at -55°C								

F92 Series



Resin-Molded Chip, Low Profile J-Lead

CAPACITANCE AND RATED VOLTAGE RANGE (LETTER DENOTES CASE SIZE)

Capacitance		Rated Voltage							*Cap Code
μF	Code	4V (0G)	6.3V (0J)	10V (1A)	16V (1C)	20V (1D)	25V (1E)	35V (1V)	
0.22	224							A	J
0.33	334							A	N
0.47	474				P	A/P		A	S
0.68	684				P	A			W
1.0	105			P	P	A/P	A/P	A	A
1.5	155			P	P	A			E
2.2	225		P	P	A/P	A	A/B	B	J
3.3	335	P	P	A/P	A			B	N
4.7	475	P	P	A/P	A/B	A ^(M) /B	A/B		S
6.8	685	P	P	A/P	B				w
10	106	A/P	A/P	A/P ^(M)	A/B	B			a
15	156	P	A/P ^(M)	A					e
22	226	A/P ^(M)	A/P ^(M)	A/B	B				J
33	336	A/P ^(M)	A/B	B					n
47	476	A/B	A/B	B					s
68	686	A ^(M) /B							w
100	107	A ^(M) /B	A ^{(M)**} /B						A
150	157	B ^(M)							E
220	227								J

Released ratings (M tolerance only)

**Rated temperature 60°C only. Please contact AVX when you need detail spec.

Please contact to your local AVX sales office when these series are being designed in your application.

F92 Series



Resin-Molded Chip, Low Profile J-Lead

RATINGS & PART NUMBER REFERENCE

AVX Part No.	Case Size	Capacitance (µF)	Rated Voltage (V)	DCL (µA)	DF @ 120Hz (%)	ESR @ 100kHz (Ω)	100kHz RMS Current (mA)				*1 ΔC/C (%)	MSL
							25°C	60°C	85°C	125°C		
4 Volt												
F920G335#PA	P	3.3	4	0.5	8	12.0	50	–	45	20	*	1
F920G475#PA	P	4.7	4	0.5	8	6.0	71	–	64	28	*	1
F920G685#PA	P	6.8	4	0.5	10	6.0	71	–	64	28	*	1
F920G106#AA	A	10	4	0.5	8	4.0	122	–	110	49	*	1
F920G106#PA	P	10	4	0.5	10	6.0	71	–	64	28	*	1
F920G156#PA	P	15	4	0.6	10	5.0	77	–	70	31	*	1
F920G226#AA	A	22	4	0.9	12	2.8	146	–	132	59	*	1
F920G226#MPA	P	22	4	0.9	20	5.0	77	–	70	31	*	1
F920G336#AA	A	33	4	1.3	12	2.8	146	–	132	59	*	1
F920G336#MPA	P	33	4	1.3	20	4.0	87	–	78	35	*	1
F920G476#AA	A	47	4	1.9	18	2.8	146	–	132	59	*	1
F920G476#BA	B	47	4	1.9	12	1.7	210	–	189	84	*	1
F920G686#AA	A	68	4	2.7	25	2.8	146	–	132	59	±15	1
F920G686#BA	B	68	4	2.7	18	1.5	224	–	201	89	*	1
F920G107#AA	A	100	4	4.0	30	2.8	146	–	132	59	±15	1
F920G107#BA	B	100	4	4.0	18	1.3	240	–	216	96	*	1
F920G157#MBA	B	150	4	6.0	25	1.3	240	–	216	96	±15	1
6.3 Volt												
F920J225#PA	P	2.2	6.3	0.5	8	12.0	50	–	45	20	*	1
F920J335#PA	P	3.3	6.3	0.5	8	12.0	50	–	45	20	*	1
F920J475#PA	P	4.7	6.3	0.5	8	6.0	71	–	64	28	*	1
F920J685#PA	P	6.8	6.3	0.5	10	6.0	71	–	64	28	*	1
F920J106#AA	A	10	6.3	0.6	8	4.0	122	–	110	49	*	1
F920J106#PA	P	10	6.3	0.6	10	6.0	71	–	64	28	*	1
F920J156#AA	A	15	6.3	0.9	8	4.0	122	–	110	49	*	1
F920J156#MPA	P	15	6.3	0.9	10	6.0	71	–	64	28	*	1
F920J226#AA	A	22	6.3	1.4	12	2.8	146	–	132	59	*	1
F920J226#MPA	P	22	6.3	1.4	20	5.0	77	–	70	31	*	1
F920J336#AA	A	33	6.3	2.1	12	2.8	146	–	132	59	*	1
F920J336#BA	B	33	6.3	2.1	12	1.7	210	–	189	84	*	1
F920J476#AA	A	47	6.3	3.0	18	2.8	146	–	132	59	±15	1
F920J476#BA	B	47	6.3	3.0	12	1.7	210	–	189	84	*	3
F920J107#MAALZT	A	100	6.3	63.0	40	3.0	141	127	–	57	±20	3
F920J107#BA	B	100	6.3	6.3	20	1.3	240	–	216	96	±15	1
10 Volt												
F921A105#PA	P	1	10	0.5	8	12.0	50	–	45	20	*	1
F921A155#PA	P	1.5	10	0.5	8	12.0	50	–	45	20	*	1
F921A225#PA	P	2.2	10	0.5	8	12.0	50	–	45	20	*	1
F921A335#AA	A	3.3	10	0.5	6	7.0	93	–	83	37	*	1
F921A335#PA	P	3.3	10	0.5	8	12.0	50	–	45	20	*	1
F921A475#AA	A	4.7	10	0.5	6	4.0	122	–	110	49	*	1
F921A475#PA	P	4.7	10	0.5	8	6.0	71	–	64	28	*	1
F921A685#AA	A	6.8	10	0.7	6	4.0	122	–	110	49	*	1
F921A685#PA	P	6.8	10	0.7	8	6.0	71	–	64	28	*	1
F921A106#AA	A	10	10	1.0	8	4.0	122	–	110	49	*	1
F921A106#MPA	P	10	10	1.0	14	6.0	71	–	64	28	*	1
F921A156#AA	A	15	10	1.5	8	4.0	122	–	110	49	*	1
F921A226#AA	A	22	10	2.2	14	4.0	122	–	110	49	±15	1
F921A226#BA	B	22	10	2.2	8	1.9	199	–	179	79	*	3
F921A336#BA	B	33	10	3.3	12	1.9	199	–	179	79	*	1
F921A476#BA	B	47	10	4.7	18	1.9	199	–	179	79	±15	1
16 Volt												
F921C474#PA	P	0.47	16	0.5	8	20.0	39	–	35	15	*	1
F921C684#PA	P	0.68	16	0.5	8	12.0	50	–	45	20	*	1
F921C105#PA	P	1	16	0.5	8	12.0	50	–	45	20	*	1
F921C155#PA	P	1.5	16	0.5	8	12.0	50	–	45	20	*	1
F921C225#AA	A	2.2	16	0.5	6	7.0	93	–	83	37	*	1
F921C225#PA	P	2.2	16	0.5	8	12.0	50	–	45	20	*	1
F921C335#AA	A	3.3	16	0.5	6	7.0	93	–	83	37	*	1
F921C475#AA	A	4.7	16	0.8	6	7.0	93	–	83	37	*	1
F921C475#BA	B	4.7	16	0.8	6	3.0	158	–	142	63	*	1
F921C685#BA	B	6.8	16	1.1	6	3.0	158	–	142	63	*	1
F921C106#AA	A	10	16	1.6	8	7.0	93	–	83	37	±15	1
F921C106#BA	B	10	16	1.6	6	2.0	194	–	174	77	*	1
F921C226#BA	B	22	16	3.5	12	2.0	194	–	174	77	±15	1
20 Volt												
F921D474#AA	A	0.47	20	0.5	4	10.0	77	–	70	31	*	1
F921D474#PA	P	0.47	20	0.5	8	20.0	39	–	35	15	*	1
F921D684#AA	A	0.68	20	0.5	4	10.0	77	–	70	31	*	1
F921D105#AA	A	1	20	0.5	4	10.0	77	–	70	31	*	1
F921D105#PA	P	1	20	0.5	8	20.0	39	–	35	15	*	1
F921D155#AA	A	1.5	20	0.5	6	7.4	90	–	81	36	*	1
F921D225#AA	A	2.2	20	0.5	6	7.0	93	–	83	37	*	1

RATINGS & PART NUMBER REFERENCE

AVX Part No.	Case Size	Capacitance (μF)	Rated Voltage (V)	DCL (μA)	DF @ 120Hz (%)	ESR @ 100kHz (Ω)	100kHz RMS Current (mA)				*1 ΔC/C (%)	MSL
							25°C	60°C	85°C	125°C		
F921D475MAA	A	4.7	20	0.9	10	7.0	93	–	83	37	±10	1
F921D475#BA	B	4.7	20	0.9	6	3.0	158	–	142	63	*	1
F921D106#BA	B	10	20	2.0	8	3.0	158	–	142	63	±10	1
25 Volt												
F921E105#AA	A	1	25	0.5	6	10.0	77	–	70	31	*	1
F921E105#PA	P	1	25	0.5	8	20.0	39	–	35	15	*	1
F921E225#AA	A	2.2	25	0.6	8	10.0	77	–	70	31	±15	1
F921E225#BA	B	2.2	25	0.6	6	4.0	137	–	123	55	*	1
F921E475#AA	A	4.7	25	1.2	10	7.0	93	–	83	37	±10	1
F921E475#BA	B	4.7	25	1.2	6	3.0	158	–	142	63	*	1
35 Volt												
F921V224#AA	A	0.22	35	0.5	4	10.0	77	–	70	31	*	1
F921V334#AA	A	0.33	35	0.5	4	10.0	77	–	70	31	*	1
F921V474#AA	A	0.47	35	0.5	4	10.0	77	–	70	31	*	1
F921V105#AA	A	1	35	0.5	6	10.0	77	–	70	31	*	1
F921V225#BA	B	2.2	35	0.8	6	4.0	137	–	123	55	±10	1
F921V335#BA	B	3.3	35	1.2	10	4.0	137	–	123	55	±10	1

1: ΔC/C Marked “”

Item	P Case (%)	A, B Case (%)
Damp Heat	±20	±10
Temperature cycles	±10	±5
Resistance soldering heat	±10	±5
Surge	±10	±5
Endurance	±10	±10

#: “M” for ±20% tolerance, “K” for ± 10% tolerance. When you need K tolerance for the part numbers which have M tolerance only, please contact to your local AVX sales office.

Moisture Sensitivity Level (MSL) is defined according to J-STD-020.

We can consider the type of compliance to AEC-Q200. Please contact to your local AVX sales office when these series are being designed in your application.

QUALIFICATION TABLE

TEST	F92 series (Temperature range -55°C to +125°C)	
	Condition	
Damp Heat (Steady State)	P Case	A, B Case
	At 40°C, 90 to 95% R.H., 500 hours (No voltage applied)	
	Capacitance Change Refer to page 28 (*1) Dissipation Factor 150% or less than the initial specified value Leakage Current Initial specified value or less	Refer to page 28 (*1) Initial specified value or less Initial specified value or less
Temperature Cycles	-55°C / +125°C, 30 minutes each, 5 cycles	
	Capacitance Change Refer to page 28 (*1) Dissipation Factor 150% or less than the initial specified value Leakage Current Initial specified value or less	Refer to page 28 (*1) Initial specified value or less Initial specified value or less
	10 seconds reflow at 260°C, 5 seconds immersion at 260°C.	
Resistance to Soldering Heat	Capacitance Change Refer to page 28 (*1) Dissipation Factor 150% or less than the initial specified value Leakage Current Initial specified value or less	Refer to page 28 (*1) Initial specified value or less Initial specified value or less
	After application of surge voltage in series with a 33Ω (For “P” case: 1kΩ) resistor at the rate of 30 seconds ON, 30 seconds OFF, for 1000 successive test cycles at 85°C, capacitors shall meet the characteristic requirements in the table above.	
	Capacitance Change Refer to page 28 (*1) Dissipation Factor 150% or less than the initial specified value Leakage Current Initial specified value or less	Refer to page 28 (*1) Initial specified value or less Initial specified value or less
Endurance	After 2000 hours’ application of rated voltage in series with a 3Ω resistor at 85°C, or derated voltage in series with a 3Ω resistor at 125°C, capacitors shall meet the characteristic requirements in the table above.	
	Capacitance Change Refer to page 28 (*1) Dissipation Factor 150% or less than the initial specified value Leakage Current Initial specified value or less	Refer to page 28 (*1) Initial specified value or less Initial specified value or less
Shear Test	After applying the pressure load of 5N for 10±1 seconds horizontally to the center of capacitor side body which has no electrode and has been soldered beforehand on a substrate, there shall be found neither exfoliation nor its sign at the terminal electrode.	
Terminal Strength	Keeping a capacitor surface-mounted on a substrate upside down and supporting the substrate at both of the opposite bottom points 45mm apart from the center of capacitor, the pressure strength is applied with a specified jig at the center of substrate so that the substrate may bend by 1mm as illustrated. Then, there shall be found no remarkable abnormality on the capacitor terminals.	

AVX SOLID ELECTROLYTE CAPACITOR ROADMAP



Five Capacitor Construction Styles

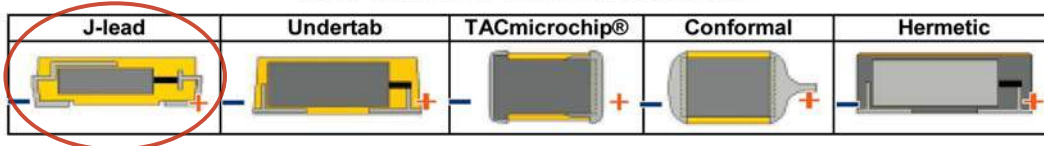

SERIES LINE UP: CONVENTIONAL SMD MnO₂

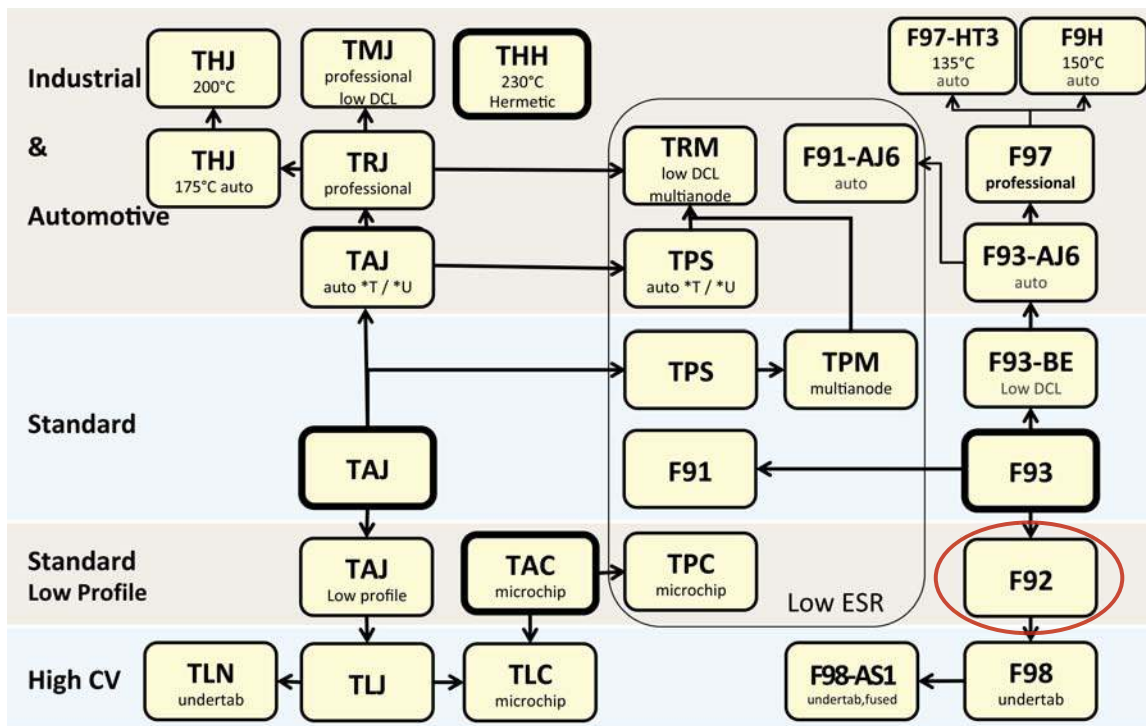

Looking for pricing, stock, or lifecycle information?

Click below to explore more details on WIN SOURCE:

 [View F920J226MBA](#) on WIN SOURCE

 [AVX Corporation](#) Information

Optimize Your Supply Chain with WIN SOURCE Solutions

-  Global Sourcing Solution
-  Obsolete Management
-  Cost Control Management
-  Shortage Management
-  Alternative Solution
-  Excess Inventory Management