



**THE DATASHEET OF  
EL5412IRE-T7**



EL5412

40MHz Rail-to-Rail Input-Output Op Amp

FN7394  
Rev 1.00  
December 22, 2004

The EL5412 is a low power, high voltage rail-to-rail input-output amplifier containing four amplifiers in one package. Operating on supplies ranging from 5V to 15V, while consuming only 2.5mA per amplifier, the EL5412 has a bandwidth of 40MHz (-3dB). It also provides common mode input ability beyond the supply rails, as well as rail-to-rail output capability. This enables this amplifier to offer maximum dynamic range at any supply voltage.

The EL5412 also features fast slewing and settling times, as well as a high output drive capability of 65mA (sink and source), continuous current, and ±190mA short-circuit current. These features make this amplifier ideal for high speed filtering and signal conditioning and V<sub>COM</sub> driving applications. Other applications include battery-powered and portable devices and anywhere low power consumption is important.

The EL5412 is available in both the 14-pin TSSOP and 14-pin HTSSOP packages and features a standard operational amplifier pinout. They are specified for operation over the full -40°C to +85°C temperature range.

Ordering Information

PART NUMBER	PACKAGE	TAPE & REEL	PKG. DWG. #
EL5412IR	14-Pin TSSOP	-	MDP0044
EL5412IR-T7	14-Pin TSSOP	7"	MDP0044
EL5412IR-T13	14-Pin TSSOP	13"	MDP0044
EL5412IRZ (See Note)	14-Pin TSSOP (Pb-free)	-	MDP0044
EL5412IRZ-T7 (See Note)	14-Pin TSSOP (Pb-free)	7"	MDP0044
EL5412IRZ-T13 (See Note)	14-Pin TSSOP (Pb-free)	13"	MDP0044
EL5412IRE	14-Pin HTSSOP	-	MDP0048
EL5412IRE-T7	14-Pin HTSSOP	7"	MDP0048
EL5412IRE-T13	14-Pin HTSSOP	13"	MDP0048

NOTE: Intersil Pb-free products employ special Pb-free material sets; molding compounds/die attach materials and 100% matte tin plate termination finish, which are RoHS compliant and compatible with both SnPb and Pb-free soldering operations. Intersil Pb-free products are MSL classified at Pb-free peak reflow temperatures that meet or exceed the Pb-free requirements of IPC/JEDEC J STD-020C.

Features

- 40MHz -3dB bandwidth
- Supply voltage = 4.5V to 16.5V
- Low supply current (per amplifier) = 2.5mA
- High slew rate = 55V/μs
- Unity-gain stable
- Beyond the rails input capability
- Rail-to-rail output swing
- ±190mA output short current
- Pb-Free Available (RoHS Compliant)

Applications

- TFT-LCD panels
- V<sub>COM</sub> amplifiers
- Drivers for A-to-D converters
- Data acquisition
- Video processing
- Audio processing
- Active filters
- Test equipment
- Battery-powered applications
- Portable equipment

Pinout

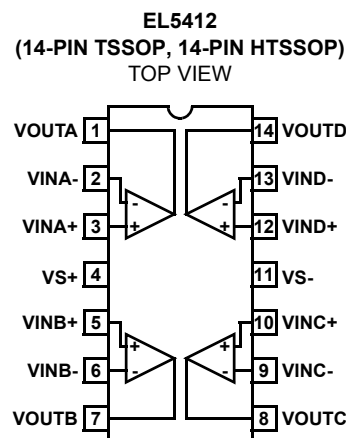

**Absolute Maximum Ratings** ( $T_A = 25^\circ\text{C}$ )

Supply Voltage between  $V_{S+}$  and  $V_{S-}$  ..... +18V  
 Input Voltage .....  $V_{S-} - 0.5\text{V}$ ,  $V_{S+} + 0.5\text{V}$   
 Maximum Continuous Output Current ..... 65mA  
 Maximum Die Temperature ..... +125°C

Storage Temperature ..... -65°C to +150°C  
 Ambient Operating Temperature ..... -40°C to +85°C  
 Power Dissipation ..... See Curves

**CAUTION:** Stresses above those listed in "Absolute Maximum Ratings" may cause permanent damage to the device. This is a stress only rating and operation of the device at these or any other conditions above those indicated in the operational sections of this specification is not implied.

**IMPORTANT NOTE:** All parameters having Min/Max specifications are guaranteed. Typ values are for information purposes only. Unless otherwise noted, all tests are at the specified temperature and are pulsed tests, therefore:  $T_J = T_C = T_A$

**Electrical Specifications**  $V_{S+} = +5\text{V}$ ,  $V_{S-} = -5\text{V}$ ,  $R_L = 1\text{k}\Omega$  to 0V,  $T_A = 25^\circ\text{C}$ , unless otherwise specified.

PARAMETER	DESCRIPTION	CONDITIONS	MIN	TYP	MAX	UNIT
<b>INPUT CHARACTERISTICS</b>						
$V_{OS}$	Input Offset Voltage	$V_{CM} = 0\text{V}$		3	15	mV
$TCV_{OS}$	Average Offset Voltage Drift (Note 1)			7		$\mu\text{V}/^\circ\text{C}$
$I_B$	Input Bias Current	$V_{CM} = 0\text{V}$		2	60	nA
$R_{IN}$	Input Impedance			1		$\text{G}\Omega$
$C_{IN}$	Input Capacitance			2		pF
CMIR	Common-Mode Input Range		-5.5		+5.5	V
CMRR	Common-Mode Rejection Ratio	for $V_{IN}$ from -5.5V to 5.5V	50	70		dB
$A_{VOL}$	Open-Loop Gain	$-4.5\text{V} \leq V_{OUT} \leq 4.5\text{V}$	60	74		dB
<b>OUTPUT CHARACTERISTICS</b>						
$V_{OL}$	Output Swing Low	$I_L = -5\text{mA}$		-4.92	-4.85	V
$V_{OH}$	Output Swing High	$I_L = 5\text{mA}$	4.85	4.92		V
$I_{SC}$	Short-circuit Current			$\pm 195$		mA
$I_{OUT}$	Output Current			$\pm 65$		mA
<b>POWER SUPPLY PERFORMANCE</b>						
PSRR	Power Supply Rejection Ratio	$V_S$ is moved from $\pm 2.25\text{V}$ to $\pm 7.75\text{V}$	60	80		dB
$I_S$	Supply Current (Per Amplifier)	No load		2.5	3.75	mA
<b>DYNAMIC PERFORMANCE</b>						
SR	Slew Rate (Note 2)	$-4.0\text{V} \leq V_{OUT} \leq 4.0\text{V}$ , 20% to 80%		55		$\text{V}/\mu\text{s}$
$t_S$	Settling to +0.1% ( $A_V = +1$ )	( $A_V = +1$ ), $V_O = 2\text{V}$ Step		120		ns
BW	-3dB Bandwidth			40		MHz
GBWP	Gain-Bandwidth Product			22		MHz
PM	Phase Margin			52		$^\circ$
CS	Channel Separation	$f = 5\text{MHz}$		110		dB
$d_G$	Differential Gain (Note 3)	$R_F = R_G = 1\text{k}\Omega$ and $V_{OUT} = 1.4\text{V}$		0.12		%
$d_P$	Differential Phase (Note 3)	$R_F = R_G = 1\text{k}\Omega$ and $V_{OUT} = 1.4\text{V}$		0.17		$^\circ$

## NOTES:

1. Measured over operating temperature range
2. Slew rate is measured on rising and falling edges
3. NTSC signal generator used

**Electrical Specifications**  $V_{S+} = +5V$ ,  $V_{S-} = 0V$ ,  $R_L = 1k\Omega$  to  $2.5V$ ,  $T_A = 25^\circ C$ , unless otherwise specified.

PARAMETER	DESCRIPTION	CONDITION	MIN	TYP	MAX	UNIT
<b>INPUT CHARACTERISTICS</b>						
$V_{OS}$	Input Offset Voltage	$V_{CM} = 2.5V$		3	15	mV
$TCV_{OS}$	Average Offset Voltage Drift (Note 1)			7		$\mu V/^\circ C$
$I_B$	Input Bias Current	$V_{CM} = 2.5V$		2	60	nA
$R_{IN}$	Input Impedance			1		$G\Omega$
$C_{IN}$	Input Capacitance			2		pF
CMIR	Common-Mode Input Range		-0.5		+5.5	V
CMRR	Common-Mode Rejection Ratio	for $V_{IN}$ from -0.5V to 5.5V	45	66		dB
$A_{VOL}$	Open-Loop Gain	$0.5V \leq V_{OUT} \leq 4.5V$	60	74		dB
<b>OUTPUT CHARACTERISTICS</b>						
$V_{OL}$	Output Swing Low	$I_L = -5mA$		80	150	mV
$V_{OH}$	Output Swing High	$I_L = 5mA$	4.85	4.92		V
$I_{SC}$	Short-circuit Current			$\pm 195$		mA
$I_{OUT}$	Output Current			$\pm 65$		mA
<b>POWER SUPPLY PERFORMANCE</b>						
PSRR	Power Supply Rejection Ratio	$V_S$ is moved from 4.5V to 15.5V	60	80		dB
$I_S$	Supply Current (Per Amplifier)	No Load		2.5	3.75	mA
<b>DYNAMIC PERFORMANCE</b>						
SR	Slew Rate (Note 2)	$1V \leq V_{OUT} \leq 4V$ , 20% o 80%		55		$V/\mu s$
$t_S$	Settling to +0.1% ( $A_V = +1$ )	( $A_V = +1$ ), $V_O = 2V$ Step		120		ns
BW	-3dB Bandwidth			40		MHz
GBWP	Gain-Bandwidth Product			22		MHz
PM	Phase Margin			52		°
CS	Channel Separation	$f = 5MHz$		110		dB
$d_G$	Differential Gain (Note 3)	$R_F = R_G = 1k\Omega$ and $V_{OUT} = 1.4V$		0.30		%
$d_P$	Differential Phase (Note 3)	$R_F = R_G = 1k\Omega$ and $V_{OUT} = 1.4V$		0.66		°

## NOTES:

1. Measured over operating temperature range
2. Slew rate is measured on rising and falling edges
3. NTSC signal generator used

**Electrical Specifications**  $V_{S+} = +15V$ ,  $V_{S-} = 0V$ ,  $R_L = 1k\Omega$  to  $7.5V$ ,  $T_A = 25^\circ C$ , unless otherwise specified.

PARAMETER	DESCRIPTION	CONDITION	MIN	TYP	MAX	UNIT
<b>INPUT CHARACTERISTICS</b>						
$V_{OS}$	Input Offset Voltage	$V_{CM} = 7.5V$		3	15	mV
$TCV_{OS}$	Average Offset Voltage Drift (Note 1)			7		$\mu V/^\circ C$
$I_B$	Input Bias Current	$V_{CM} = 7.5V$		2	60	nA
$R_{IN}$	Input Impedance			1		$G\Omega$
$C_{IN}$	Input Capacitance			2		pF
CMIR	Common-Mode Input Range		-0.5		+15.5	V
CMRR	Common-Mode Rejection Ratio	for $V_{IN}$ from -0.5V to 15.5V	53	72		dB
$A_{VOL}$	Open-Loop Gain	$0.5V \leq V_{OUT} \leq 14.5V$	60	74		dB
<b>OUTPUT CHARACTERISTICS</b>						
$V_{OL}$	Output Swing Low	$I_L = -7.5mA$		80	150	mV
$V_{OH}$	Output Swing High	$I_L = 7.5mA$	14.85	14.92		V
$I_{SC}$	Short-circuit Current		$\pm 180$	$\pm 195$		mA
$I_{OUT}$	Output Current			$\pm 65$		mA
<b>POWER SUPPLY PERFORMANCE</b>						
PSRR	Power Supply Rejection Ratio	$V_S$ is moved from 4.5V to 15.5V	60	80		dB
$I_S$	Supply Current (Per Amplifier)	No Load		2.5	3.75	mA
<b>DYNAMIC PERFORMANCE</b>						
SR	Slew Rate (Note 2)	$1V \leq V_{OUT} \leq 14V$ , 20% o 80%		55		$V/\mu s$
$t_S$	Settling to +0.1% ( $A_V = +1$ )	( $A_V = +1$ ), $V_O = 2V$ Step		120		ns
BW	-3dB Bandwidth			40		MHz
GBWP	Gain-Bandwidth Product			22		MHz
PM	Phase Margin			52		$^\circ$
CS	Channel Separation	$f = 5MHz$		110		dB
$d_G$	Differential Gain (Note 3)	$R_F = R_G = 1k\Omega$ and $V_{OUT} = 1.4V$		0.10		%
$d_P$	Differential Phase (Note 3)	$R_F = R_G = 1k\Omega$ and $V_{OUT} = 1.4V$		0.11		$^\circ$

## NOTES:

1. Measured over operating temperature range
2. Slew rate is measured on rising and falling edges
3. NTSC signal generator used

## Typical Performance Curves

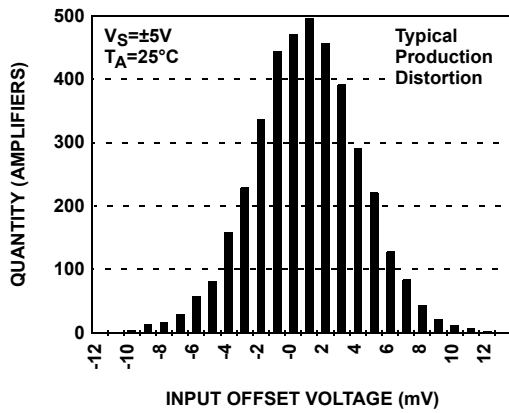

FIGURE 1. INPUT OFFSET VOLTAGE DISTRIBUTION

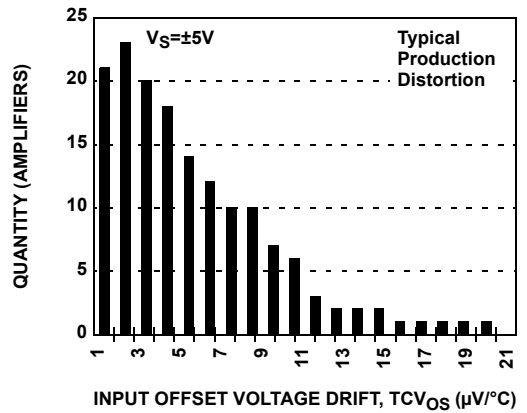

FIGURE 2. INPUT OFFSET VOLTAGE DRIFT

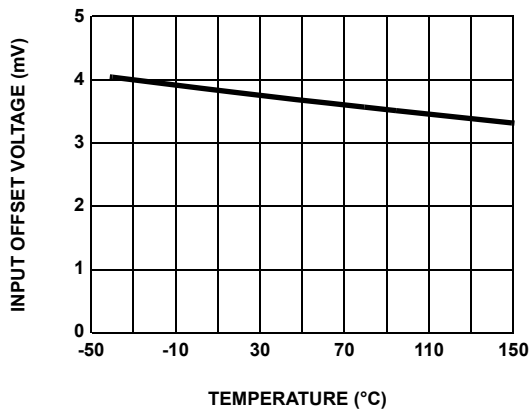

FIGURE 3. INPUT OFFSET VOLTAGE vs TEMPERATURE

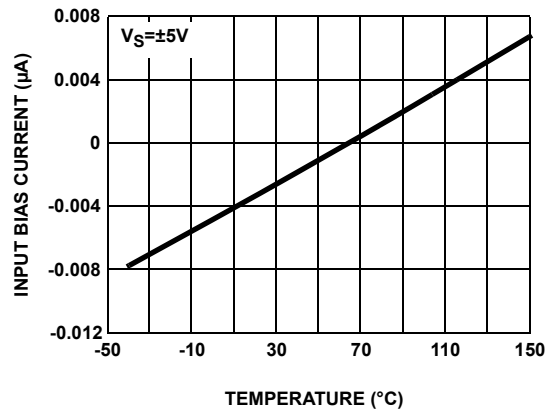

FIGURE 4. INPUT BIAS CURRENT vs TEMPERATURE

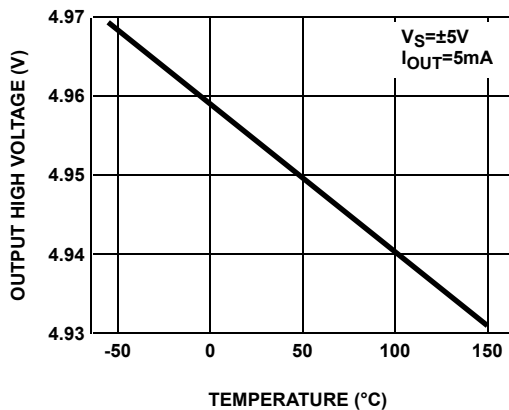

FIGURE 5. OUTPUT HIGH VOLTAGE vs TEMPERATURE

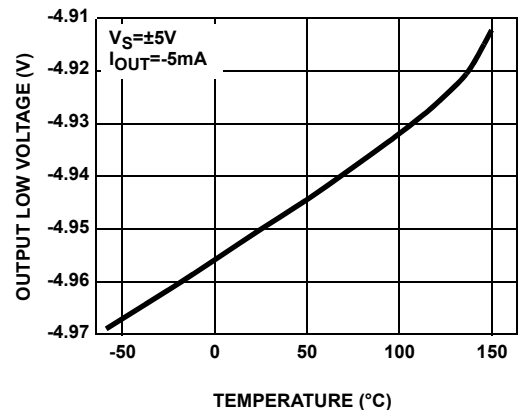

FIGURE 6. OUTPUT LOW VOLTAGE vs TEMPERATURE

**Typical Performance Curves**

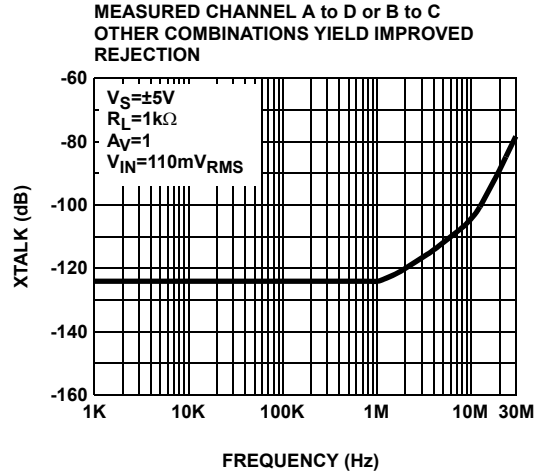

FIGURE 7. CHANNEL SEPARATION vs FREQUENCY RESPONSE

**Pin Descriptions**

PIN NO.	PIN NAME	PIN FUNCTION	EQUIVALENT CIRCUIT
1	VOUTA	Amplifier A Output	<p>CIRCUIT 1</p>
2	VINA-	Amplifier A Inverting Input	<p>CIRCUIT 2</p>
3	VINA+	Amplifier A Non-Inverting Input	(Reference Circuit 2)
4	VS+	Positive Power Supply	
5	VINB+	Amplifier B Non-Inverting Input	(Reference Circuit 2)
6	VINB-	Amplifier B Inverting Input	(Reference Circuit 2)
7	VOUTB	Amplifier B Output	(Reference Circuit 1)
8	VOUTC	Amplifier C Output	(Reference Circuit 1)
9	VINC-	Amplifier C Inverting Input	(Reference Circuit 2)
10	VINC+	Amplifier C Non-Inverting Input	(Reference Circuit 2)
11	VS-	Negative Power Supply	
12	VIND+	Amplifier D Non-Inverting Input	(Reference Circuit 2)
13	VIND-	Amplifier D Inverting Input	(Reference Circuit 2)
14	VOUTD	Amplifier D Output	(Reference Circuit 1)

## Applications Information

### Product Description

The EL5412 voltage feedback amplifier is fabricated using a high voltage CMOS process. It exhibits rail-to-rail input and output capability, is unity gain stable and has low power consumption (2.5mA per amplifier). These features make the EL5412 ideal for a wide range of general-purpose applications. Connected in voltage follower mode and driving a load of 2kΩ, the EL5412 has a -3dB bandwidth of 40MHz while maintaining a 55V/μs slew rate. The EL5412 is a quad amplifier.

### Operating Voltage, Input, and Output

The EL5412 is specified with a single nominal supply voltage from 5V to 15V or a split supply with its total range from 5V to 15V. Correct operation is guaranteed for a supply range of 4.5V to 16.5V. Most EL5412 specifications are stable over both the full supply range and operating temperatures of -40°C to +85°C. Parameter variations with operating voltage and/or temperature are shown in the typical performance curves.

The input common-mode voltage range of the EL5412 extends 500mV beyond the supply rails. The output swings of the EL5412 typically extend to within 100mV of positive and negative supply rails with load currents of 5mA. Decreasing load currents will extend the output voltage range even closer to the supply rails. Figure 8 shows the input and output waveforms for the device in the unity-gain configuration. Operation is from ±5V supply with a 1kΩ load connected to GND. The input is a 10V<sub>P-P</sub> sinusoid. The output voltage is approximately 9.8V<sub>P-P</sub>.

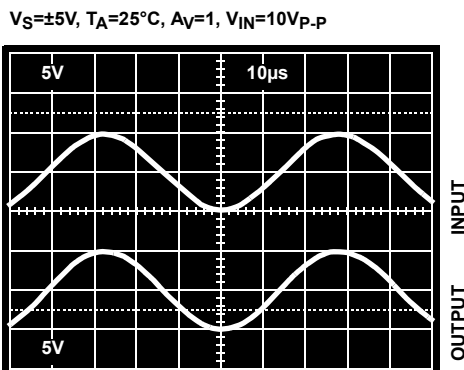

FIGURE 8. OPERATION WITH RAIL-TO-RAIL INPUT AND OUTPUT

### Output Current Driving Capability

The EL5412 will limit the short-circuit current to ±190mA if the output is directly shorted to the positive or the negative supply. If an output is shorted indefinitely, the power dissipation could easily increase such that the device may be damaged. Maximum reliability is maintained if the output continuous current never exceeds ±65mA. This limit is set by the design of the internal metal interconnects.

### Output Phase Reversal

The EL5412 is immune to phase reversal as long as the input voltage is limited from  $V_S - 0.5V$  to  $V_S + 0.5V$ . Figure 9 shows a photo of the output of the device with the input voltage driven beyond the supply rails. Although the device's output will not change phase, the input's overvoltage should be avoided. If an input voltage exceeds supply voltage by more than 0.6V, electrostatic protection diodes placed in the input stage of the device begin to conduct and overvoltage damage could occur.

$V_S = \pm 2.5V, T_A = 25^\circ C, A_V = 1, V_{IN} = 6V_{P-P}$

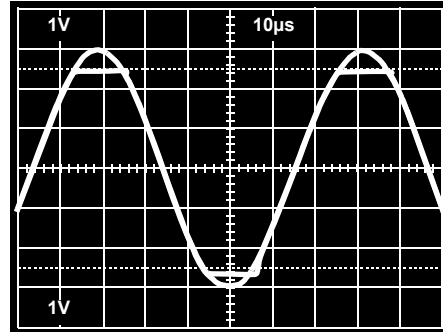

FIGURE 9. OPERATION WITH BEYOND-THE-RAILS INPUT

### Power Dissipation

With the high-output drive capability of the EL5412 amplifier, it is possible to exceed the 125°C 'absolute-maximum junction temperature' under certain load current conditions. Therefore, it is important to calculate the maximum junction temperature for the application to determine if load conditions need to be modified for the amplifier to remain in the safe operating area.

The maximum power dissipation allowed in a package is determined according to:

$$P_{DMAX} = \frac{T_{JMAX} - T_{AMAX}}{\Theta_{JA}}$$

where:

- $T_{JMAX}$  = Maximum junction temperature
- $T_{AMAX}$  = Maximum ambient temperature
- $\Theta_{JA}$  = Thermal resistance of the package
- $P_{DMAX}$  = Maximum power dissipation in the package

The maximum power dissipation actually produced by an IC is the total quiescent supply current times the total power supply voltage, plus the power in the IC due to the loads, or:

$$P_{DMAX} = \sum i[V_S \times I_{SMAX} + (V_S + -V_{OUTi}) \times I_{LOADi}]$$

when sourcing, and:

$$P_{DMAX} = \sum i[V_S \times I_{SMAX} + (V_{OUTi} - V_S) \times I_{LOADi}]$$

when sinking.

Where:

- $i$  = Channel 1 to 4
- $V_S$  = Total supply voltage
- $I_{S_{MAX}}$  = Maximum supply current per amplifier
- $V_{OUTi}$  = Maximum output voltage of the application
- $I_{LOADi}$  = Load current

If we set the two  $P_{D_{MAX}}$  equations equal to each other, we can solve for  $R_{LOADi}$  to avoid device overheat. Figure 10 and Figure 11 provide a convenient way to see if the device will overheat. The maximum safe power dissipation can be found graphically, based on the package type and the ambient temperature. By using the previous equation, it is a simple matter to see if  $P_{D_{MAX}}$  exceeds the device's power derating curves. To ensure proper operation, it is important to observe the recommended derating curves shown in Figures 10 and 11.

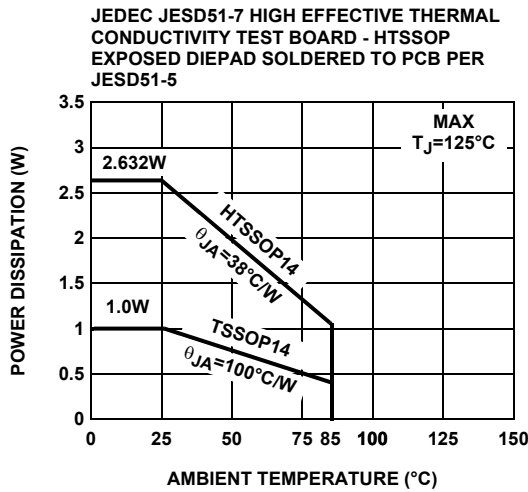

FIGURE 10. PACKAGE POWER DISSIPATION vs AMBIENT TEMPERATURE

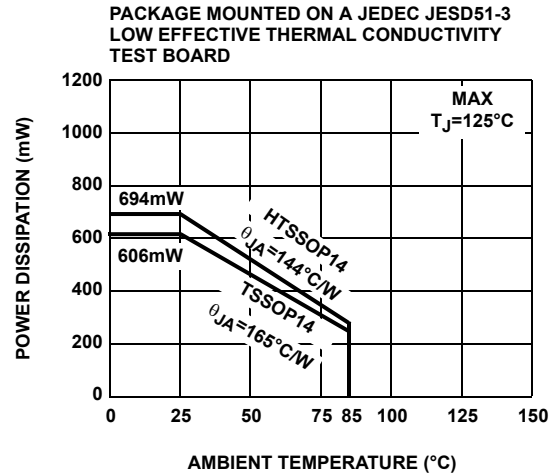

FIGURE 11. PACKAGE POWER DISSIPATION vs AMBIENT TEMPERATURE

**Unused Amplifiers**

It is recommended that any unused amplifiers be configured as a unity gain follower. The inverting input should be directly connected to the output and the non-inverting input tied to the ground plane.

**Power Supply Bypassing and Printed Circuit Board Layout**

The EL5412 can provide gain at high frequency. As with any high-frequency device, good printed circuit board layout is necessary for optimum performance. Ground plane construction is highly recommended, lead lengths should be as short as possible and the power supply pins must be well bypassed to reduce the risk of oscillation. For normal single supply operation, where the  $V_{S-}$  pin is connected to ground, a 0.1µF ceramic capacitor should be placed from  $V_{S+}$  to pin to  $V_{S-}$  pin. A 4.7µF tantalum capacitor should then be connected in parallel, placed in the region of the amplifier. One 4.7µF capacitor may be used for multiple devices. This same capacitor combination should be placed at each supply pin to ground if split supplies are to be used.

© Copyright Intersil Americas LLC 2003-2004. All Rights Reserved.  
 All trademarks and registered trademarks are the property of their respective owners.

For additional products, see [www.intersil.com/en/products.html](http://www.intersil.com/en/products.html)

Intersil products are manufactured, assembled and tested utilizing ISO9001 quality systems as noted in the quality certifications found at [www.intersil.com/en/support/qualandreliability.html](http://www.intersil.com/en/support/qualandreliability.html)

*Intersil products are sold by description only. Intersil may modify the circuit design and/or specifications of products at any time without notice, provided that such modification does not, in Intersil's sole judgment, affect the form, fit or function of the product. Accordingly, the reader is cautioned to verify that datasheets are current before placing orders. Information furnished by Intersil is believed to be accurate and reliable. However, no responsibility is assumed by Intersil or its subsidiaries for its use; nor for any infringements of patents or other rights of third parties which may result from its use. No license is granted by implication or otherwise under any patent or patent rights of Intersil or its subsidiaries.*

For information regarding Intersil Corporation and its products, see [www.intersil.com](http://www.intersil.com)

## Looking for pricing, stock, or lifecycle information?

Click below to explore more details on WIN SOURCE:

 [View EL5412IRE-T7 on WIN SOURCE](#)

 [Intersil Information](#)

## Optimize Your Supply Chain with WIN SOURCE Solutions

-  Global Sourcing Solution
-  Obsolete Management
-  Cost Control Management
-  Shortage Management
-  Alternative Solution
-  Excess Inventory Management