

DS2030L 3.3V Single-Piece 256kb Nonvolatile SRAM

DS2030L

General Description

The DS2030L is a 256kb reflowable nonvolatile (NV) SRAM, which consists of a static RAM (SRAM), an NV controller, and an internal rechargeable manganese lithium (ML) battery. These components are encased in a surface-mount module with a 256-ball BGA footprint. Whenever V_{CC} is applied to the module, it recharges the ML battery, powers the SRAM from the external power source, and allows the contents of the SRAM to be modified. When V_{CC} is powered down or out-of-tolerance, the controller write-protects the SRAM's contents and powers the SRAM from the battery. The DS2030L also contains a power-supply monitor output, RST, which can be used as a CPU supervisor for a microprocessor.

Applications

RAID Systems and Servers	POS Terminals
Industrial Controllers	Data-Acquisition Systems
Gaming	Fire Alarms
Router/Switches	PLCs

Features

- ◆ Single-Piece, Reflowable, 27mm² BGA Package Footprint
- ◆ Internal ML Battery and Charger
- ◆ Unconditionally Write-Protects SRAM when V_{CC} is Out-of-Tolerance
- ◆ Automatically Switches to Battery Supply when V_{CC} Power Failures Occur
- ◆ Internal Power-Supply Monitor Detects Power Fail Below Nominal V_{CC} (3.3V)
- ◆ Reset Output can be used as a CPU Supervisor for a Microprocessor
- ◆ Industrial Temperature Range (-40°C to +85°C)
- ◆ UL Recognized

Pin Configuration appears at end of data sheet.

Ordering Information

PART	TEMP RANGE	PIN-PACKAGE	SPEED (ns)	SUPPLY TOLERANCE
DS2030L-100#	-40°C to +85°C	256 Ball 27mm ² BGA Module	100	3.3V ±0.3V

#Denotes a RoHS-compliant device that may include lead that is exempt under the RoHS requirements.

Typical Operating Circuit

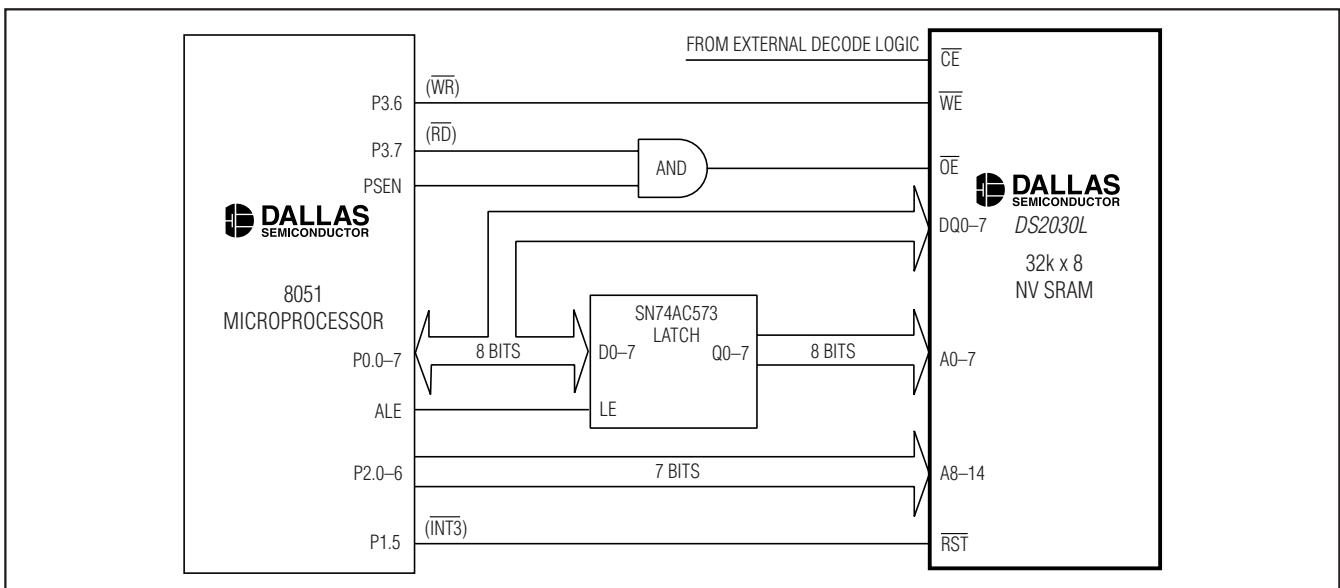

DS2030L 3.3V Single-Piece 256kb Nonvolatile SRAM

ABSOLUTE MAXIMUM RATINGS

Voltage on Any Pin Relative to Ground-0.3V to +4.6V
 Operating Temperature Range-40°C to +85°C

Storage Temperature Range-40°C to +85°C
 Soldering TemperatureSee IPC/JEDEC J-STD-020

Stresses beyond those listed under "Absolute Maximum Ratings" may cause permanent damage to the device. These are stress ratings only, and functional operation of the device at these or any other conditions beyond those indicated in the operational sections of the specifications is not implied. Exposure to absolute maximum rating conditions for extended periods may affect device reliability.

RECOMMENDED OPERATING CONDITIONS

($T_A = -40^\circ\text{C}$ to $+85^\circ\text{C}$.)

PARAMETER	SYMBOL	CONDITIONS	MIN	TYP	MAX	UNITS
Supply Voltage	V_{CC}		3.0	3.3	3.6	V
Input Logic 1	V_{IH}		2.2		V_{CC}	V
Input Logic 0	V_{IL}		0		0.4	V

DC ELECTRICAL CHARACTERISTICS

($V_{CC} = 3.3\text{V} \pm 0.3\text{V}$, $T_A = -40^\circ\text{C}$ to $+85^\circ\text{C}$.)

PARAMETER	SYMBOL	CONDITIONS	MIN	TYP	MAX	UNITS
Input Leakage Current	I_{IL}		-1.0		+1.0	μA
I/O Leakage Current	I_{IO}	$\overline{CE} = V_{CC}$	-1.0		+1.0	μA
Output-Current High	I_{OH}	At 2.4V	-1.0			mA
Output-Current Low	I_{OL}	At 0.4V	2.0			mA
Output-Current Low \overline{RST}	$I_{OL} \overline{RST}$	At 0.4V (Note 1)	10.0			mA
Standby Current	I_{CCS1}	$\overline{CE} = 2.2\text{V}$		0.5	2	mA
	I_{CCS2}	$\overline{CE} = V_{CC} - 0.2\text{V}$		0.2	1	
Operating Current	I_{CCO1}	$t_{RC} = 200\text{ns}$, outputs open			50	mA
Write Protection Voltage	V_{TP}		2.8	2.9	3.0	V

CAPACITANCE

($T_A = +25^\circ\text{C}$.)

PARAMETER	SYMBOL	CONDITIONS	MIN	TYP	MAX	UNITS
Input Capacitance	C_{IN}	Not tested		7		pF
Input/Output Capacitance	C_{OUT}	Not tested		7		pF

DS2030L 3.3V Single-Piece 256kb Nonvolatile SRAM

DS2030L

AC ELECTRICAL CHARACTERISTICS

($V_{CC} = 3.3V \pm 0.3V$, $T_A = -40^{\circ}C$ to $+85^{\circ}C$.)

PARAMETER	SYMBOL	CONDITIONS	DS2030L-100		UNITS
			MIN	MAX	
Read Cycle Time	t_{RC}		100		ns
Access Time	t_{ACC}			100	ns
\overline{OE} to Output Valid	t_{OE}			50	ns
\overline{CE} to Output Valid	t_{CO}			100	ns
\overline{OE} or \overline{CE} to Output Active	t_{COE}	(Note 2)	5		ns
Output High Impedance from Deselection	t_{OD}	(Note 2)		35	ns
Output Hold from Address Change	t_{OH}		5		ns
Write Cycle Time	t_{WC}		100		ns
Write Pulse Width	t_{WP}	(Note 3)	75		ns
Address Setup Time	t_{AW}		0		ns
Write Recovery Time	t_{WR1}	(Note 4)	5		ns
	t_{WR2}	(Note 5)	20		
Output High Impedance from \overline{WE}	t_{ODW}	(Note 2)		35	ns
Output Active from \overline{WE}	t_{OEWE}	(Note 2)	5		ns
Data Setup Time	t_{DS}	(Note 6)	40		ns
Data Hold Time	t_{DH1}	(Note 4)	0		ns
	t_{DH2}	(Note 5)	20		

POWER-DOWN/POWER-UP TIMING

($T_A = -40^{\circ}C$ to $+85^{\circ}C$.)

PARAMETER	SYMBOL	CONDITIONS	MIN	TYP	MAX	UNITS
V_{CC} Fail Detect to \overline{CE} and \overline{WE} Inactive	t_{PD}	(Note 7)			1.5	μs
V_{CC} Slew from V_{TP} to 0V	t_F		150			μs
V_{CC} Slew from 0V to V_{TP}	t_R		150			μs
V_{CC} Valid to \overline{CE} and \overline{WE} Inactive	t_{PU}				2	ms
V_{CC} Valid to End of Write Protection	t_{REC}				125	ms
V_{CC} Fail Detect to \overline{RST} Active	t_{RPD}	(Note 1)			3.0	μs
V_{CC} Valid to \overline{RST} Inactive	t_{RPU}	(Note 1)	225	350	525	ms

DATA RETENTION

($T_A = +25^{\circ}C$.)

PARAMETER	SYMBOL	CONDITIONS	MIN	TYP	MAX	UNITS
Expected Data-Retention Time (Per Charge)	t_{DR}	(Note 8)	11	16		Weeks

AC TEST CONDITIONS

- Input Pulse Levels: $V_{IL} = 0.0V$, $V_{IH} = 2.7V$
- Input Pulse Rise and Fall Times: 5ns
- Input and Output Timing Reference Level: 1.5V
- Output Load: 1 TTL Gate + C_L (100pF) including scope and jig

DS2030L 3.3V Single-Piece 256kb Nonvolatile SRAM

DS2030L

Read Cycle

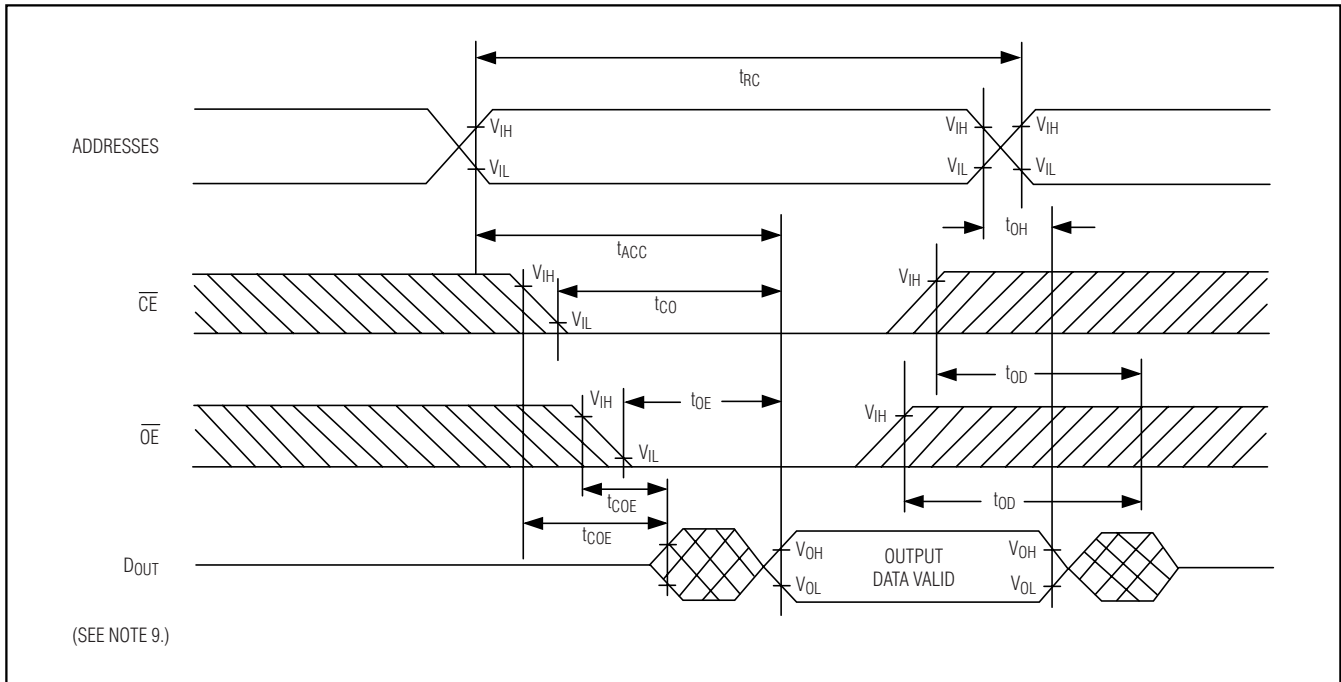

DS2030L 3.3V Single-Piece 256kb Nonvolatile SRAM

DS2030L

Write Cycle 1

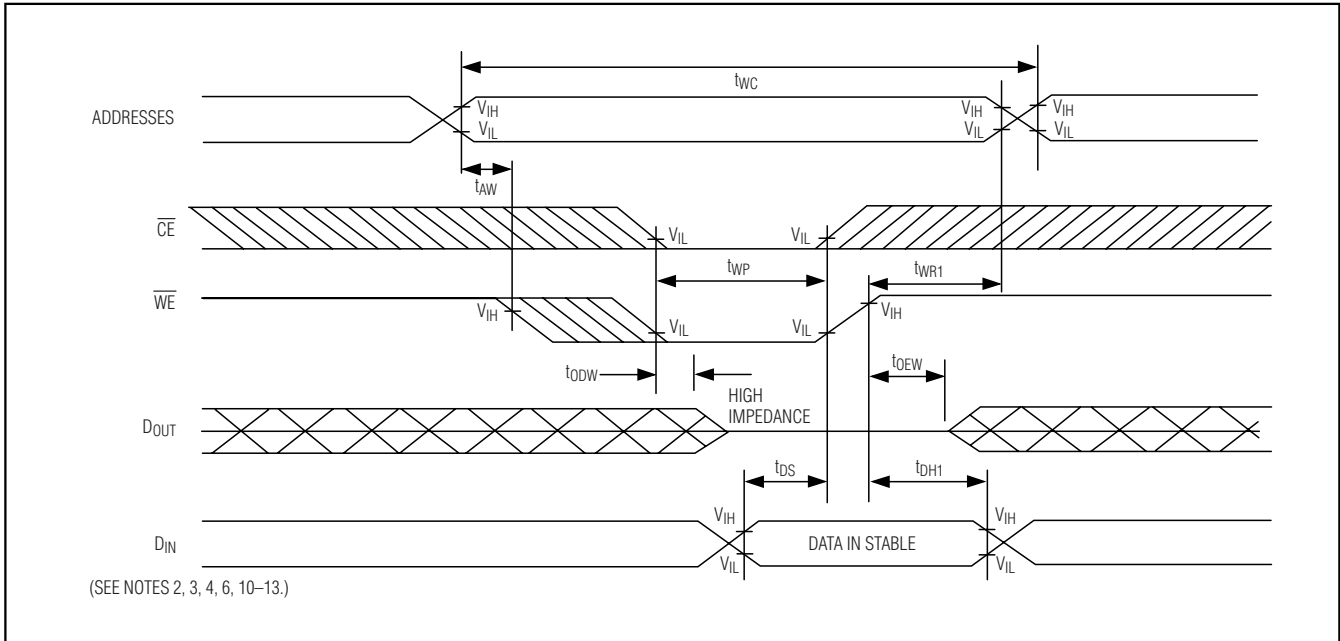

Write Cycle 2

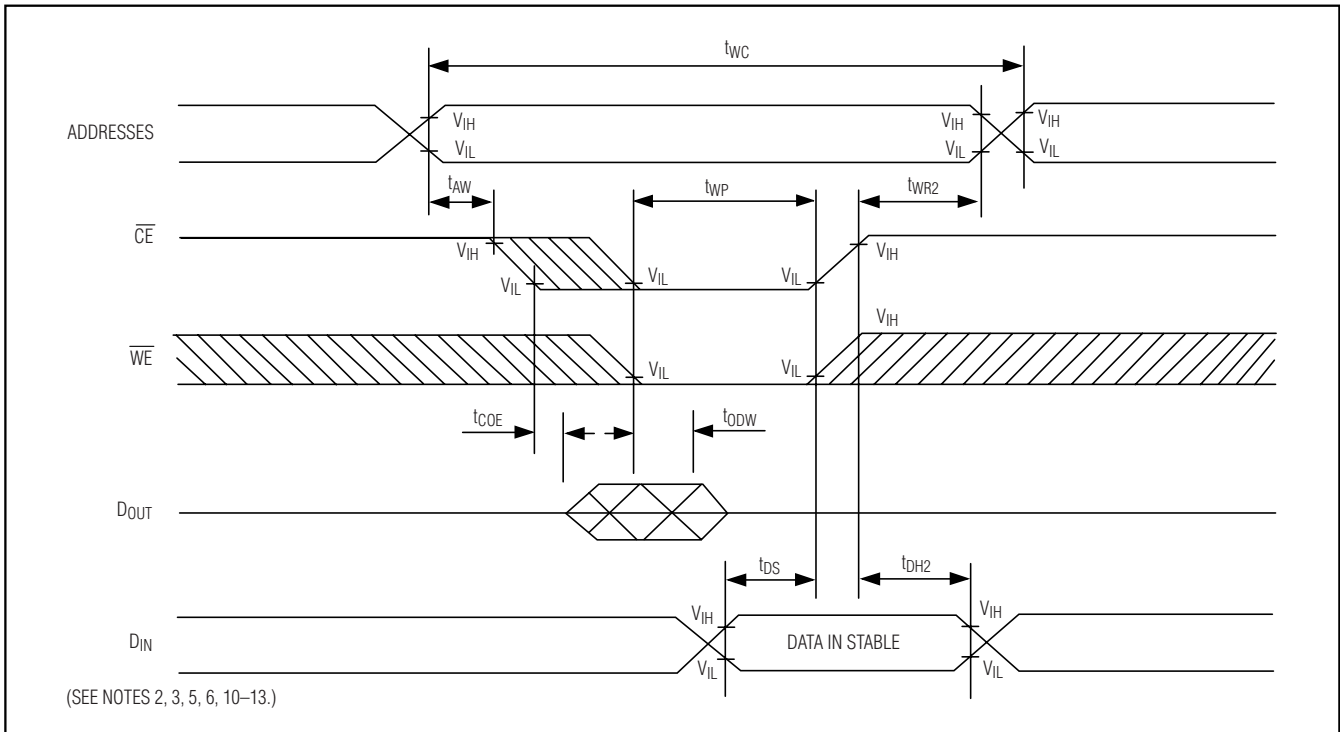

DS2030L 3.3V Single-Piece 256kb Nonvolatile SRAM

Power-Down/Power-Up Condition

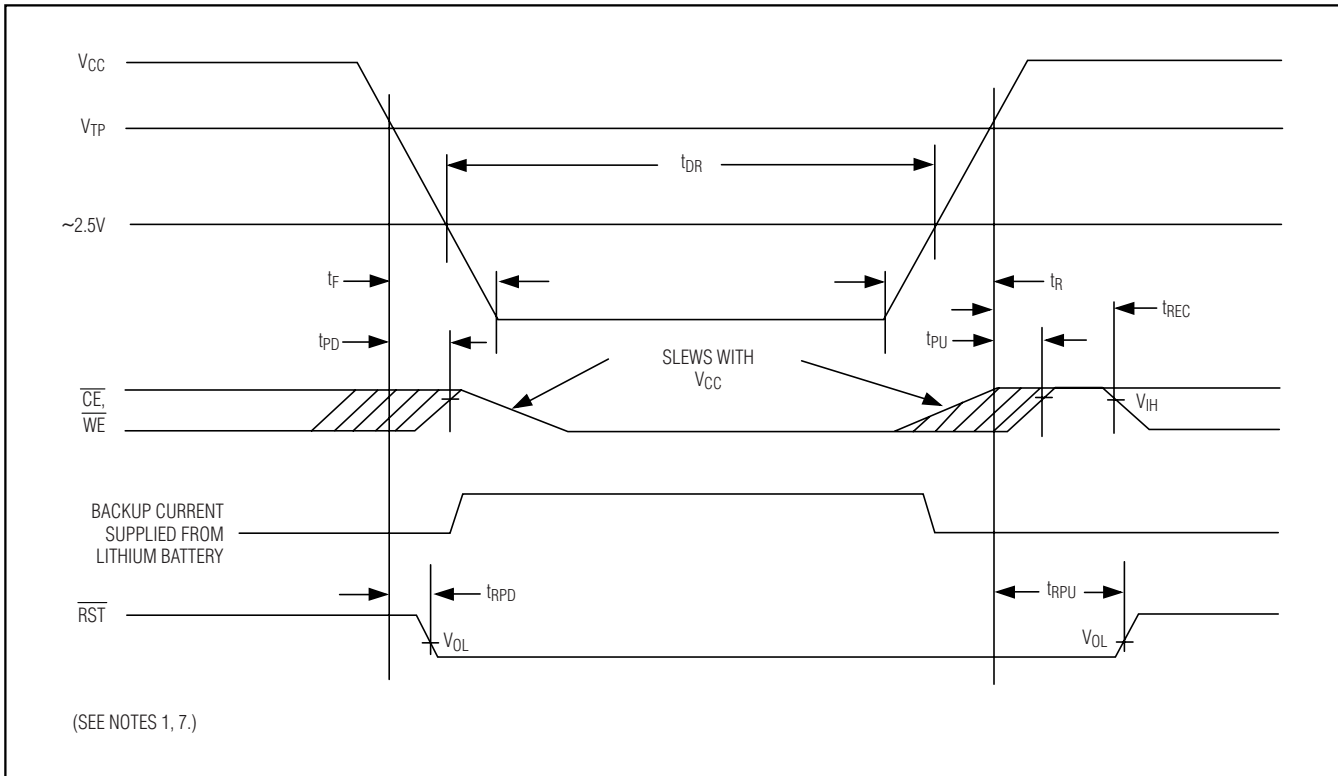

- Note 1:** \overline{RST} is an open-drain output and cannot source current. An external pullup resistor should be connected to this pin to realize a logic-high level.
- Note 2:** These parameters are sampled with a 5pF load and are not 100% tested.
- Note 3:** t_{WP} is specified as the logical AND of \overline{CE} and \overline{WE} . t_{WP} is measured from the latter of \overline{CE} or \overline{WE} going low to the earlier of \overline{CE} or \overline{WE} going high.
- Note 4:** t_{WR1} and t_{DH1} are measured from \overline{WE} going high.
- Note 5:** t_{WR2} and t_{DH2} are measured from \overline{CE} going high.
- Note 6:** t_{DS} is measured from the earlier of \overline{CE} or \overline{WE} going high.
- Note 7:** In a power-down condition, the voltage on any pin can not exceed the voltage on V_{CC} .
- Note 8:** The expected t_{DR} is defined as accumulative time in the absence of V_{CC} starting from the time power is first applied by the user. Minimum expected data-retention time is based on a maximum of two +230°C convection solder reflow exposures, followed by a fully charged cell. Full charge occurs with the initial application of V_{CC} for a minimum of 96 hours. This parameter is assured by component selection, process control, and design. It is not measured directly in production testing.
- Note 9:** \overline{WE} is high for a read cycle.
- Note 10:** $\overline{OE} = V_{IH}$ or V_{IL} . If $\overline{OE} = V_{IH}$ during write cycle, the output buffers remain in a high-impedance state.
- Note 11:** If the \overline{CE} low transition occurs simultaneously with or later than the \overline{WE} low transition, the output buffers remain in a high-impedance state during this period.
- Note 12:** If the \overline{CE} high transition occurs prior to or simultaneously with the \overline{WE} high transition, the output buffers remain in a high-impedance state during this period.
- Note 13:** If \overline{WE} is low or the \overline{WE} low transition occurs prior to or simultaneously with the \overline{CE} low transition, the output buffers remain in a high-impedance state during this period.
- Note 14:** DS2030L BGA modules are recognized by Underwriters Laboratory (UL) under file E99151.

DS2030L 3.3V Single-Piece 256kb Nonvolatile SRAM

Typical Operating Characteristics

(Conditions: $V_{CC} = +3.3V$, $T_A = +25^\circ C$, unless otherwise noted.)

DS2030L

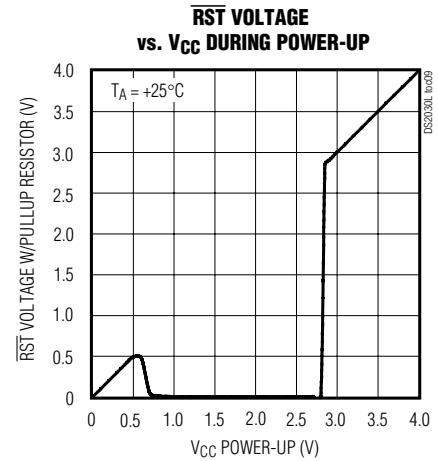
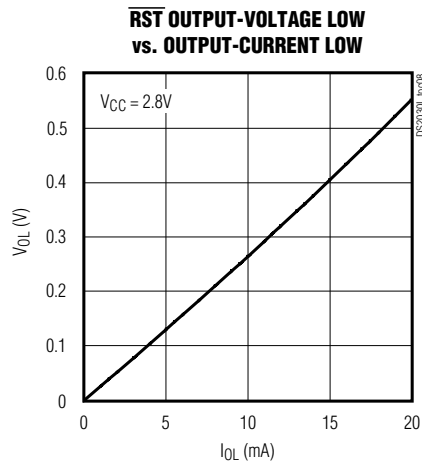
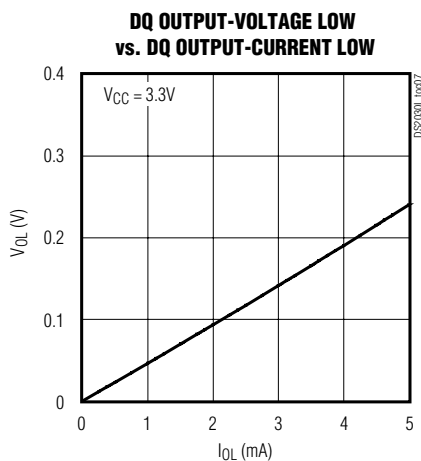
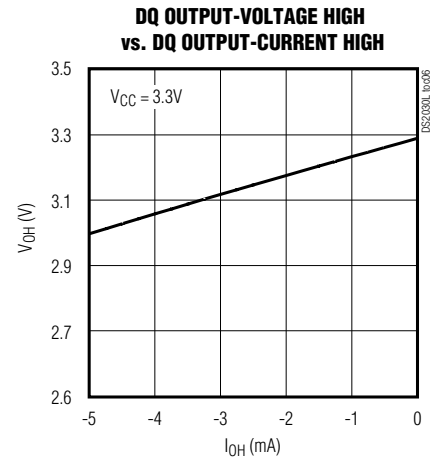
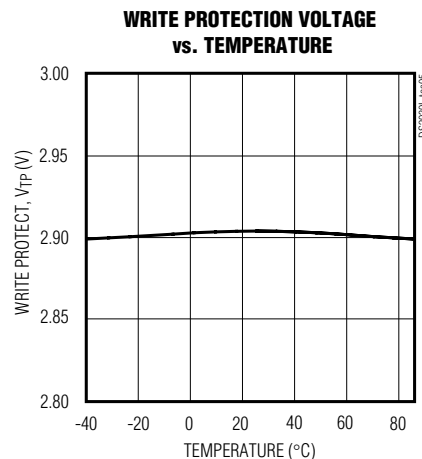
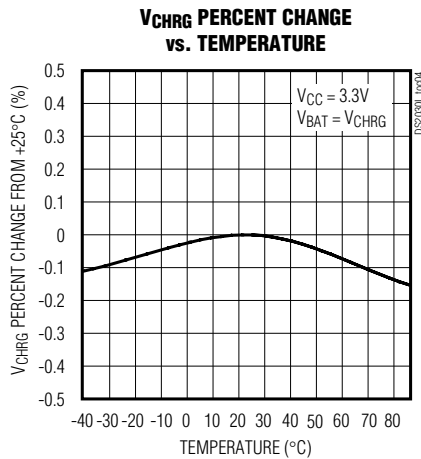
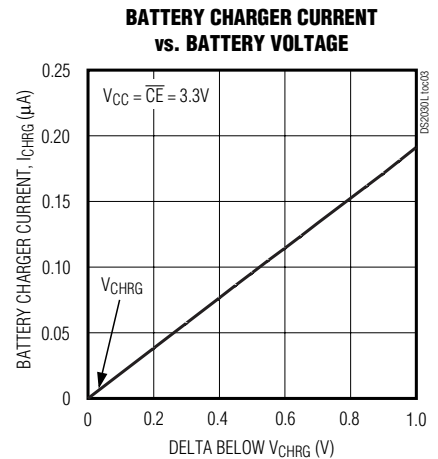
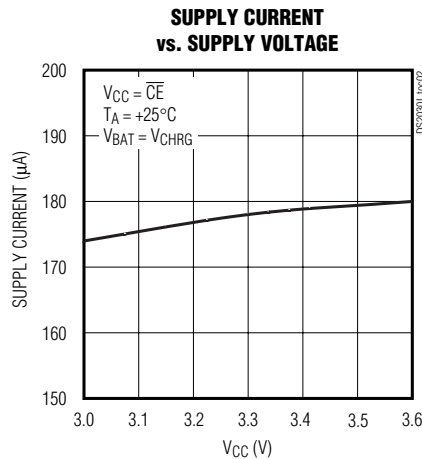
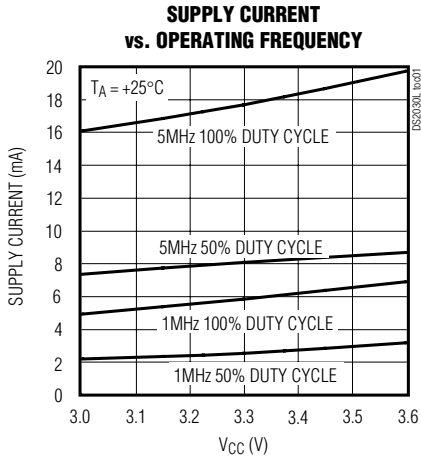

DS2030L 3.3V Single-Piece 256kb Nonvolatile SRAM

DS2030L

Pin Description

BALLS	NAME	DESCRIPTION
A1, A2, A3, A4	GND	Ground
B1, B2, B3, B4	N.C.	No Connection
C1, C2, C3, C4	N.C.	No Connection
D1, D2, D3, D4	N.C.	No Connection
E1, E2, E3, E4	\overline{RST}	Open-Drain Reset Output
F1, F2, F3, F4	V _{CC}	Supply Voltage
G1, G2, G3, G4	\overline{WE}	Write Enable Input
H1, H2, H3, H4	\overline{OE}	Output Enable Input
J1, J2, J3, J4	\overline{CE}	Chip Enable Input
K1, K2, K3, K4	DQ7	Data Input/Output 7
L1, L2, L3, L4	DQ6	Data Input/Output 6
M1, M2, M3, M4	DQ5	Data Input/Output 5
N1, N2, N3, N4	DQ4	Data Input/Output 4
P1, P2, P3, P4	DQ3	Data Input/Output 3
R1, R2, R3, R4	DQ2	Data Input/Output 2
T1, T2, T3, T4	DQ1	Data Input/Output 1
U1, U2, U3, U4	DQ0	Data Input/Output 0
V1, V2, V3, V4	GND	Ground
W1, W2, W3, W4	GND	Ground
Y1, Y2, Y3, Y4	GND	Ground
A17, A18, A19, A20	GND	Ground
B17, B18, B19, B20	N.C.	No Connection
C17, C18, C19, C20	N.C.	No Connection
D17, D18, D19, D20	A14	Address Input 14
E17, E18, E19, E20	A13	Address Input 13
F17, F18, F19, F20	A12	Address Input 12
G17, G18, G19, G20	A11	Address Input 11
H17, H18, H19, H20	A10	Address Input 10
J17, J18, J19, J20	A9	Address Input 9
K17, K18, K19, K20	A8	Address Input 8
L17, L18, L19, L20	A7	Address Input 7
M17, M18, M19, M20	A6	Address Input 6

BALLS	NAME	DESCRIPTION
N17, N18, N19, N20	A5	Address Input 5
P17, P18, P19, P20	A4	Address Input 4
R17, R18, R19, R20	A3	Address Input 3
T17, T18, T19, T20	A2	Address Input 2
U17, U18, U19, U20	A1	Address Input 1
V17, V18, V19, V20	A0	Address Input 0
W17, W18, W19, W20	GND	Ground
Y17, Y18, Y19, Y20	GND	Ground
A5, B5, C5, D5	N.C.	No Connection
A6, B6, C6, D6	N.C.	No Connection
A7, B7, C7, D7	N.C.	No Connection
A8, B8, C8, D8	N.C.	No Connection
A9, B9, C9, D9	N.C.	No Connection
A10, B10, C10, D10	N.C.	No Connection
A11, B11, C11, D11	N.C.	No Connection
A12, B12, C12, D12	N.C.	No Connection
A13, B13, C13, D13	N.C.	No Connection
A14, B14, C14, D14	N.C.	No Connection
A15, B15, C15, D15	N.C.	No Connection
A16, B16, C16, D16	N.C.	No Connection
U5, V5, W5, Y5	N.C.	No Connection
U6, V6, W6, Y6	N.C.	No Connection
U7, V7, W7, Y7	N.C.	No Connection
U8, V8, W8, Y8	N.C.	No Connection
U9, V9, W9, Y9	N.C.	No Connection
U10, V10, W10, Y10	N.C.	No Connection
U11, V11, W11, Y11	N.C.	No Connection
U12, V12, W12, Y12	N.C.	No Connection
U13, V13, W13, Y13	N.C.	No Connection
U14, V14, W14, Y14	N.C.	No Connection
U15, V15, W15, Y15	N.C.	No Connection
U16, V16, W16, Y16	N.C.	No Connection

DS2030L 3.3V Single-Piece 256kb Nonvolatile SRAM

Functional Diagram

DS2030L

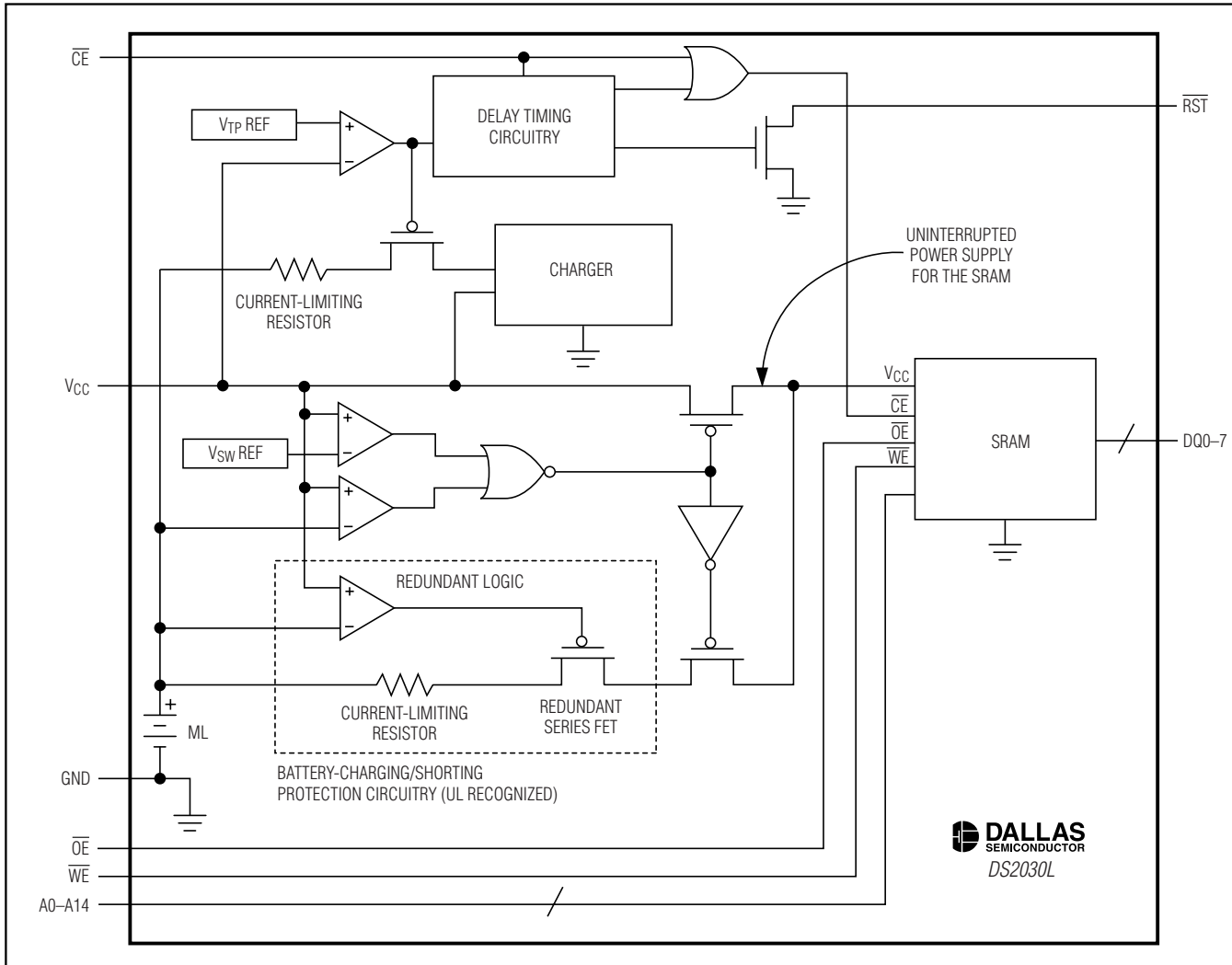

Detailed Description

The DS2030L is a 256kb (32kb x 8 bits) fully static, NV memory similar in function and organization to the DS1230W NV SRAM, but containing a rechargeable ML battery. The DS2030L NV SRAM constantly monitors VCC for an out-of-tolerance condition. When such a condition occurs, the lithium energy source is automatically switched on and write protection is unconditionally enabled to prevent data corruption. There is no limit to the number of write cycles that can be executed and no additional support circuitry is required for microprocessor interfacing. This device can be used in place of SRAM, EEPROM, or flash components.

The DS2030L assembly consists of a low-power SRAM, an ML battery, and an NV controller with a battery charger, integrated on a standard 256-ball, 27mm² BGA substrate. Unlike other surface-mount NV memory modules that require the battery to be removable for soldering, the internal ML battery can tolerate exposure to convection reflow soldering temperatures allowing this single-piece component to be handled with standard BGA assembly techniques.

The DS2030L also contains a power-supply monitor output, \overline{RST} , which can be used as a CPU supervisor for a microprocessor.

DS2030L 3.3V Single-Piece 256kb Nonvolatile SRAM

Memory Operation Truth Table

\overline{WE}	\overline{CE}	\overline{OE}	MODE	I _{CC}	OUTPUTS
1	0	0	Read	Active	Active
1	0	1	Read	Active	High Impedance
0	0	X	Write	Active	High Impedance
X	1	X	Standby	Standby	High Impedance

X = Don't care.

Read Mode

The DS2030L executes a read cycle whenever \overline{WE} (write enable) is inactive (high) and \overline{CE} (chip enable) is active (low). The unique address specified by the 15 address inputs (A0 to A14) defines which of the 32,768 bytes of data is to be accessed. Valid data will be available to the eight data output drivers within t_{ACC} (access time) after the last address input signal is stable, providing that \overline{CE} and \overline{OE} (output enable) access times are also satisfied. If \overline{CE} and \overline{OE} access times are not satisfied, then data access must be measured from the later occurring signal (\overline{CE} or \overline{OE}) and the limiting parameter is either t_{CO} for \overline{CE} or t_{OE} for \overline{OE} rather than address access.

Write Mode

The DS2030L executes a write cycle whenever the \overline{CE} and \overline{WE} signals are active (low) after address inputs are stable. The later-occurring falling edge of \overline{CE} or \overline{WE} will determine the start of the write cycle. The write cycle is terminated by the earlier rising edge of \overline{CE} or \overline{WE} . All address inputs must be kept valid throughout the write cycle. \overline{WE} must return to the high state for a minimum recovery time (t_{WR}) before another cycle can be initiated. The \overline{OE} control signal should be kept inactive (high) during write cycles to avoid bus contention. However, if the output drivers have been enabled (\overline{CE} and \overline{OE} active) then \overline{WE} will disable the outputs in t_{ODW} from its falling edge.

Data-Retention Mode

The DS2030L provides full functional capability for V_{CC} greater than 3.0V and write-protects by 2.8V. Data is maintained in the absence of V_{CC} without additional support circuitry. The NV static RAM constantly monitors V_{CC} . Should the supply voltage decay, the NV SRAM automatically write-protects itself. All inputs become "don't care", and all data outputs become high impedance. As V_{CC} falls below approximately 2.5V (V_{SW}), the power-switching circuit connects the lithium

energy source to the RAM to retain data. During power-up, when V_{CC} rises above V_{SW} , the power-switching circuit connects external V_{CC} to the RAM and disconnects the lithium energy source. Normal RAM operation can resume after V_{CC} exceeds V_{TP} for a minimum duration of t_{REC} .

Battery Charging

When V_{CC} is greater than V_{TP} , an internal regulator charges the battery. The UL-approved charger circuit includes short-circuit protection and a temperature-stabilized voltage reference for on-demand charging of the internal battery. Typical data-retention expectations of 16 weeks *per charge cycle* are achievable.

A maximum of 96 hours of charging time is required to fully charge a depleted battery.

System Power Monitoring

When the external V_{CC} supply falls below the selected out-of-tolerance trip point, the output \overline{RST} is forced active (low). Once active, the \overline{RST} is held active until the V_{CC} supply has fallen below that of the internal battery. On power-up, the \overline{RST} output is held active until the external supply is greater than the selected trip point and one reset timeout period (t_{RPU}) has elapsed. This is sufficiently longer than t_{REC} to ensure that the SRAM is ready for access by the microprocessor.

Freshness Seal and Shipping

The DS2030L is shipped from Dallas Semiconductor with the lithium battery electrically disconnected, guaranteeing that no battery capacity has been consumed during transit or storage. As shipped, the lithium battery is ~60% charged, and no preassembly charging operations should be attempted.

When V_{CC} is first applied at a level greater than V_{TP} , the lithium battery is enabled for backup operation. A 96 hour initial battery charge time is recommended for new system installations.

DS2030L 3.3V Single-Piece 256kb Nonvolatile SRAM

DS2030L

Recommended Reflow Temperature Profile

PROFILE FEATURE	Sn-Pb EUTECTIC ASSEMBLY
Average ramp-up rate (T _L to T _P)	3°C/second max
Preheat - Temperature min (T _{Smin}) - Temperature max (T _{Smax}) - Time (min to max) (ts)	100°C 150°C 60 to 120 seconds
T _{Smax} to T _L - Ramp-up rate	
Time maintained above: - Temperature (T _L) - Time (t _L)	183°C 60 to 150 seconds
Peak temperature (T _P)	225 +0/-5°C
Time within 5°C of actual peak temperature (T _P)	10 to 30 seconds
Ramp-down rate	6°C/second max
Time 25°C to peak temperature	6 minutes max

Note: All temperatures refer to top side of the package, measured on the package body surface.

Recommended Cleaning Procedures

The DS2030L may be cleaned using aqueous-based cleaning solutions. No special precautions are needed when cleaning boards containing a DS2030L module.

Removal of the topside label violates the environmental integrity of the package and voids the warranty of the product.

Applications Information

Power-Supply Decoupling

To achieve the best results when using the DS2030L, decouple the power supply with a 0.1µF capacitor. Use a high-quality, ceramic surface-mount capacitor if possible. Surface-mount components minimize lead inductance, which improves performance, while ceramic capacitors have adequately high frequency response for decoupling applications.

Using the Open-Drain \overline{RST} Output

The \overline{RST} output is open drain, and therefore requires a pullup resistor to realize a high logic output level. Pullup resistor values between 1kΩ and 10kΩ are typical.

Battery Charging/Lifetime

The DS2030L charges an ML battery to maximum capacity in approximately 96 hours of operation when V_{CC} is greater than V_{TP}. Once the battery is charged, its lifetime depends primarily on the V_{CC} duty cycle. The DS2030L can maintain data from a single, initial charge for up to 16 weeks. Once recharged, this deep-discharge cycle can be repeated up to 20 times, producing a worst-case service life of 6 years. More typical duty cycles are of shorter duration, enabling the DS2030L to be charged hundreds of times, therefore extending the service life well beyond 6 years.

DS2030L 3.3V Single-Piece 256kb Nonvolatile SRAM

Pin Configuration

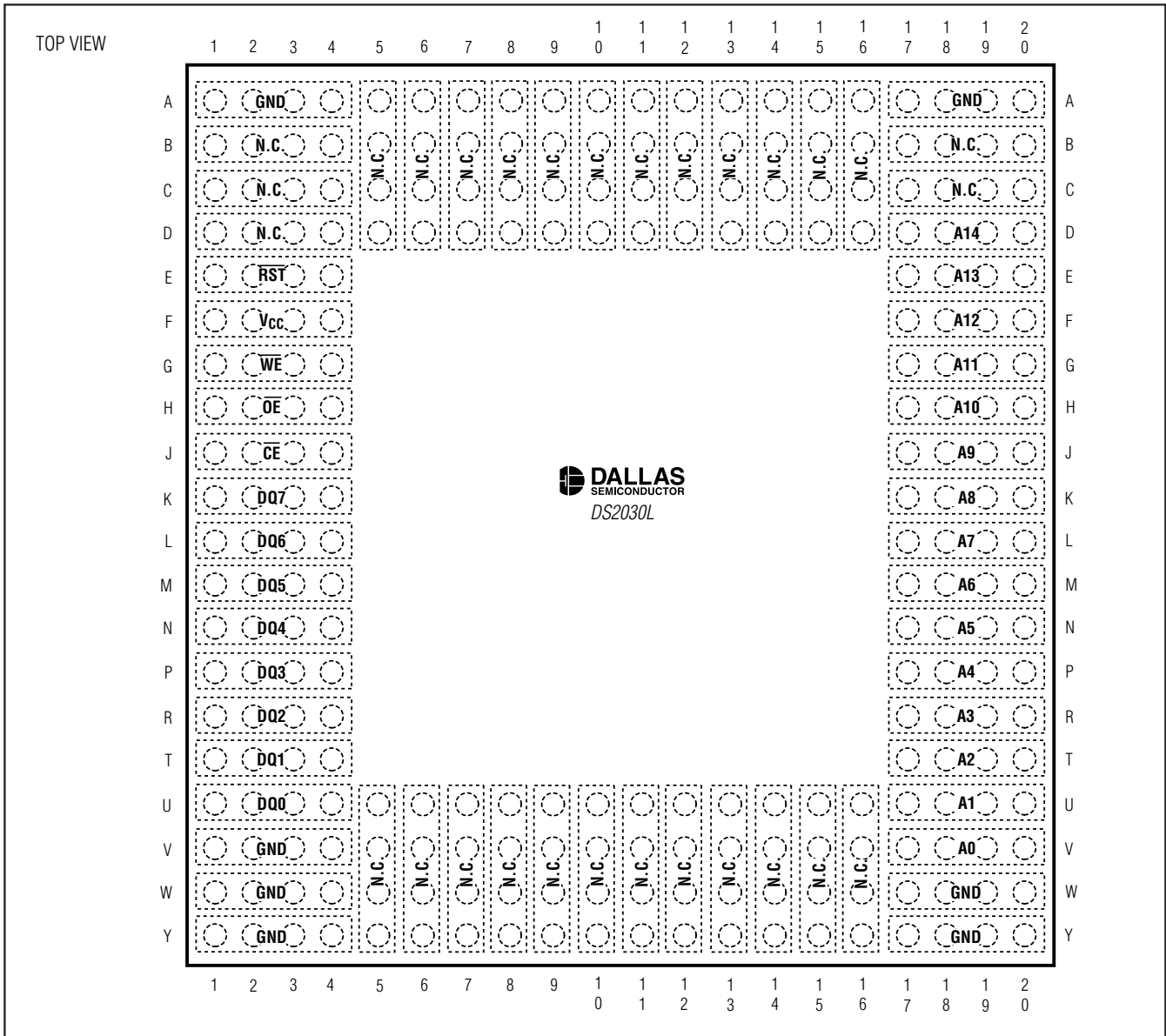

Revision History

Pages changed at Rev 3: 1, 3, 12

Package Information

For the latest package outline information, go to www.maxim-ic.com/DallasPackInfo.

Maxim cannot assume responsibility for use of any circuitry other than circuitry entirely embodied in a Maxim product. No circuit patent licenses are implied. Maxim reserves the right to change the circuitry and specifications without notice at any time.

12 Maxim Integrated Products, 120 San Gabriel Drive, Sunnyvale, CA 94086 408-737-7600

Looking for pricing, stock, or lifecycle information?

Click below to explore more details on WIN SOURCE:

- ⊖ [View DS2030L-100#](#) on WIN SOURCE
- ⊖ [Maxim Integrated](#) Information

Optimize Your Supply Chain with WIN SOURCE Solutions

- ✓ Global Sourcing Solution
- ✓ Obsolete Management
- ✓ Cost Control Management
- ✓ Shortage Management
- ✓ Alternative Solution
- ✓ Excess Inventory Management