



**THE DATASHEET OF
DS1000M-500**



FEATURES

- All-silicon time delay
- 5 taps equally spaced
- Delays are stable and precise
- Both leading and trailing edge accuracy
- Delay tolerance $\pm 5\%$ or ± 2 ns, whichever is greater
- Economical
- Auto-insertable, low profile
- Low-power CMOS
- TTL/CMOS-compatible
- Vapor phase, IR and wave solderable
- Custom delays available
- Fast turn prototypes
- Extended temperature range available

DESCRIPTION

The DS1000 series delay lines have five equally spaced taps providing delays from 4 ns to 500 ns. These devices are offered in a standard 14-pin DIP that is pin-compatible with hybrid delay lines. Alternatively, 8-pin DIPs and surface mount packages are available to save PC board area. Low cost and superior reliability over hybrid technology is achieved by the combination of a 100% silicon delay line and industry standard DIP and SOIC packaging. In order to maintain complete pin compatibility, DIP packages are available with hybrid lead configurations. The DS1000 series delay lines pro-

PIN ASSIGNMENT

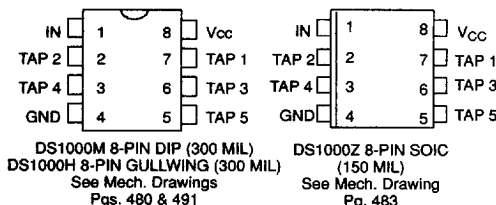
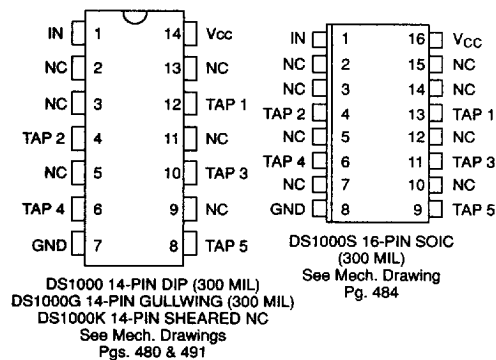

PIN DESCRIPTION

TAP 1-TAP 5 - TAP Output Number
 V_{CC} - +5 Volts
 GND - Ground
 NC - No Connection
 IN - Input

vide a nominal accuracy of $\pm 5\%$ or ± 2 ns, whichever is greater. The DS1000 5-Tap Silicon Delay Line reproduces the input logic state at the output after a fixed delay as specified by the extension of the part number after the dash. The DS1000 is designed to reproduce both leading and trailing edges with equal precision. Each tap is capable of driving up to ten 74LS loads.

Dallas Semiconductor can customize standard products to meet special needs. For special requests and rapid delivery, call (214) 450-5348.

2614130 0009997 407

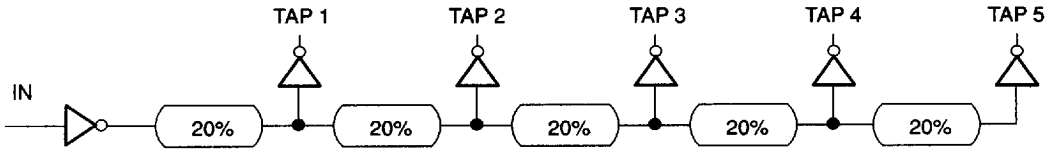
LOGIC DIAGRAM Figure 1**PART NUMBER DELAY TABLE (t_{PHL} , t_{PLH})** Table 1

PART NO.	TAP 1	TAP 2	TAP 3	TAP 4	TAP 5
DS1000-20	4 ns	8 ns	12 ns	16 ns	20 ns
DS1000-25	5 ns	10 ns	15 ns	20 ns	25 ns
DS1000-30	6 ns	12 ns	18 ns	24 ns	30 ns
DS1000-35	7 ns	14 ns	21 ns	28 ns	35 ns
DS1000-40	8 ns	16 ns	24 ns	32 ns	40 ns
DS1000-45	9 ns	18 ns	27 ns	36 ns	45 ns
DS1000-50	10 ns	20 ns	30 ns	40 ns	50 ns
DS1000-60	12 ns	24 ns	36 ns	48 ns	60 ns
DS1000-75	15 ns	30 ns	45 ns	60 ns	75 ns
DS1000-100	20 ns	40 ns	60 ns	80 ns	100 ns
DS1000-125	25 ns	50 ns	75 ns	100 ns	125 ns
DS1000-150	30 ns	60 ns	90 ns	120 ns	150 ns
DS1000-175	35 ns	70 ns	105 ns	140 ns	175 ns
DS1000-200	40 ns	80 ns	120 ns	160 ns	200 ns
DS1000-250	50 ns	100 ns	150 ns	200 ns	250 ns
DS1000-350	70 ns	140 ns	210 ns	280 ns	350 ns
DS1000-450	90 ns	180 ns	270 ns	360 ns	450 ns
DS1000-500	100 ns	200 ns	300 ns	400 ns	500 ns

Custom delays available.

2614130 0009998 343 ■

ABSOLUTE MAXIMUM RATINGS*

Voltage on Any Pin Relative to Ground
 Operating Temperature
 Storage Temperature
 Soldering Temperature
 Short Circuit Output Current

-1.0V to +7.0V
 0°C to 70°C
 -55°C to +125°C
 260°C for 10 seconds
 50 mA for 1 second

* This is a stress rating only and functional operation of the device at these or any other conditions above those indicated in the operation sections of this specification is not implied. Exposure to absolute maximum rating conditions for extended periods of time may affect reliability.

DC ELECTRICAL CHARACTERISTICS(0°C to 70°C; $V_{CC} = 5.0V \pm 5\%$)

PARAMETER	SYM	TEST CONDITION	MIN	TYP	MAX	UNITS	NOTES
Supply Voltage	V_{CC}		4.75	5.00	5.25	V	1
High Level Input Voltage	V_{IH}		2.2		$V_{CC} + 0.5$	V	1
Low Level Input Voltage	V_{IL}		-0.5		0.8	V	1
Input Leakage Current	I_I	$0.0V \leq V_I \leq V_{CC}$	-1.0		1.0	μA	
Active Current	I_{CC}	$V_{CC} = \text{Max}; \text{Period} = \text{Min.}$		35	75	mA	2,8
High Level Output Current	I_{OH}	$V_{CC} = \text{Min. } V_{OH} = 4$			-1	mA	
Low Level Output Current	I_{OL}	$V_{CC} = \text{Min. } V_{OL} = 0.5$	12			mA	

AC ELECTRICAL CHARACTERISTICS(T_A = 25°C; $V_{CC} = 5V \pm 5\%$)

PARAMETER	SYMBOL	MIN	TYP	MAX	UNITS	NOTES
Input Pulse Width	t_{WI}	40% of Tap 5 t_{PLH}			ns	7
Input to Tap Delay (leading edge)	t_{PLH}		Table 1		ns	3, 4, 5, 6, 9
Input to Tap Delay (trailing edge)	t_{PHL}		Table 1		ns	3, 4, 5, 6, 9
Power-up Time	t_{PU}			100	ms	
	Period	4 (t_{WI})			ns	7

CAPACITANCE(T_A = 25°C)

PARAMETER	SYMBOL	MIN	TYP	MAX	UNITS	NOTES
Input Capacitance	C_{IN}		5	10	pF	

NOTES:

1. All voltages are referenced to ground.
2. Measured with outputs open.
3. $V_{CC} = 5V @ 25^{\circ}C$. Delays accurate on both rising and falling edges within ± 2 ns or 5%, whichever is greater.
4. For DS1000 delay lines with a TAP 5 delay of 50 ns or greater, temperature variations from $25^{\circ}C$ to $0^{\circ}C$ or $70^{\circ}C$ may produce an additional input to tap delay shift of ± 1 ns or $\pm 3\%$, whichever is greater.
5. For DS1000 delay lines with a TAP 5 delay less than 50 ns, temperature variations from $25^{\circ}C$ to $0^{\circ}C$ or $70^{\circ}C$ may produce an additional input to tap delay shift of ± 1 ns or $\pm 10\%$, whichever is greater.
6. All tap delays tend to vary unidirectionally with temperature or voltage changes. For example, if TAP 1 slows down, all other taps also slow down; TAP3 can never be faster than TAP2.
7. Pulse width and period specifications may be exceeded; however, accuracy will be application-sensitive (decoupling, layout, etc.).
8. I_{CC} is a function of frequency and TAP 5 delay. Only a -25 operating with a 40 ns period and $V_{CC} = 5.25V$ will have an $I_{CC} = 75$ mA. For example a -100 will never exceed 30 mA, etc.
9. See "Test Conditions" section at the end of this data sheet.

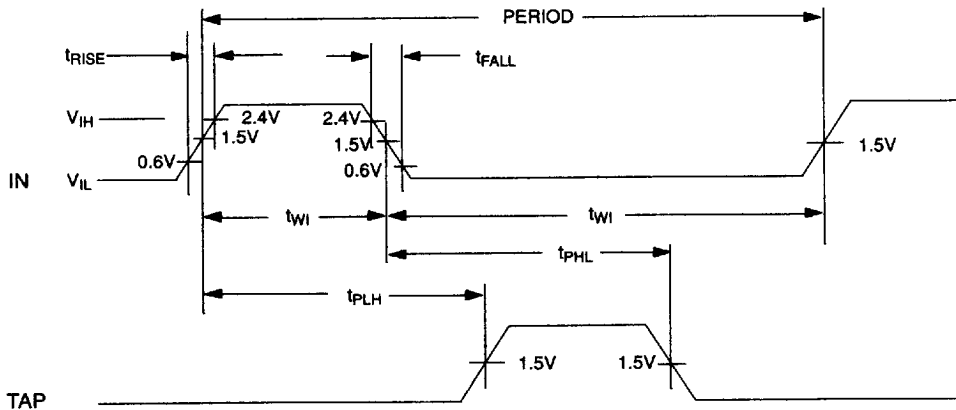
TIMING DIAGRAM-SILICON DELAY LINE Figure 2

2614130 0010000 495

030194 4/6

TEST CIRCUIT Figure 3

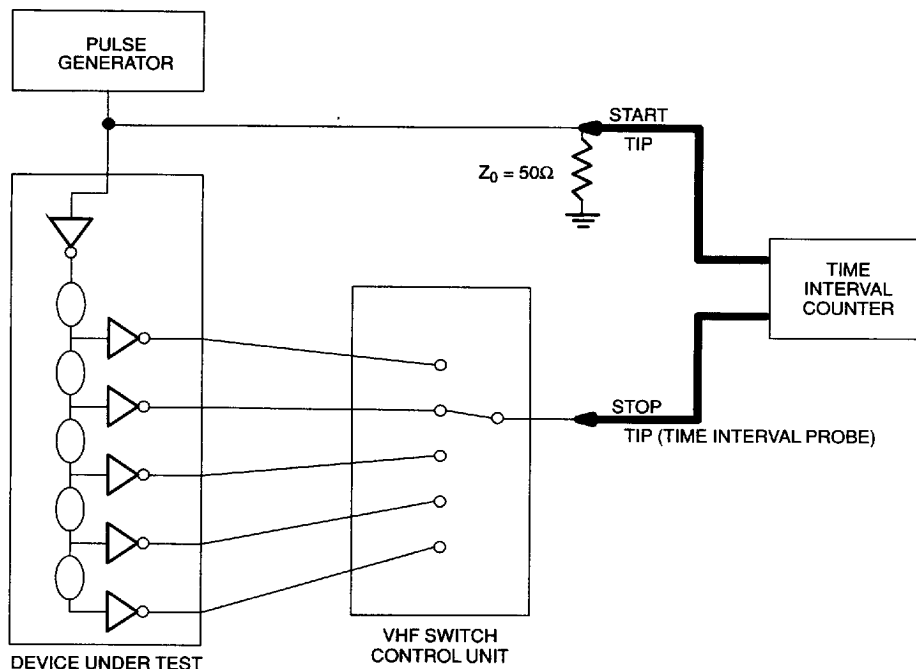

TERMINOLOGY

Period: The time elapsed between the leading edge of the first pulse and the leading edge of the following pulse.

t_{WI} (Pulse Width): The elapsed time on the pulse between the 1.5V point on the leading edge and the 1.5V point on the trailing edge or the 1.5V point on the trailing edge and the 1.5V point on the leading edge.

t_{RISE} (Input Rise Time): The elapsed time between the 20% and the 80% point on the leading edge of the input pulse.

t_{FALL} (Input Fall Time): The elapsed time between the 80% and the 20% point on the trailing edge of the input pulse.

t_{PLH} (Time Delay, Rising): The elapsed time between the 1.5V point on the leading edge of the input pulse and the 1.5V point on the leading edge of any tap output pulse.

t_{PHL} (Time Delay, Falling): The elapsed time between the 1.5V point on the trailing edge of the input pulse and the 1.5V point on the trailing edge of any tap output pulse.

TEST SETUP DESCRIPTION

Figure 3 illustrates the hardware configuration used for measuring the timing parameters on the DS1000. The input waveform is produced by a precision pulse generator under software control. Time delays are measured by a time interval counter (20 ps resolution) connected between the input and each tap. Each tap is selected and connected to the counter by a VHF switch control unit. All measurements are fully automated, with each instrument controlled by a central computer over an IEEE 488 bus.

TEST CONDITIONS**INPUT :**

Ambient Temperature: $25^{\circ}\text{C} \pm 3^{\circ}\text{C}$
Supply Voltage (V_{CC}): $5.0\text{V} \pm 0.1\text{V}$
Input Pulse: High = $3.0\text{V} \pm 0.1\text{V}$
Low = $0.0\text{V} \pm 0.1\text{V}$
Source Impedance: 50 ohm Max.
Rise and Fall Time: 3.0 ns Max. (measured
between 0.6V and 2.4V)
Pulse Width: 500 ns (1 μs for -500)
Period: 1 μs (2 μs for -500)

OUTPUT:



Each output is loaded with the equivalent of one 74F04 input gate. Delay is measured at the 1.5V level on the rising and falling edge.

NOTE:



Above conditions are for test only and do not restrict the operation of the device under other data sheet conditions.

Looking for pricing, stock, or lifecycle information?

Click below to explore more details on WIN SOURCE:

-  [View DS1000M-500 on WIN SOURCE](#)
-  [Maxim Integrated](#) Information

Optimize Your Supply Chain with WIN SOURCE Solutions

-  Global Sourcing Solution
-  Obsolete Management
-  Cost Control Management
-  Shortage Management
-  Alternative Solution
-  Excess Inventory Management