



**THE DATASHEET OF
DR1030-121-R**



DR1030

Shielded power inductors



Description

- Shielded drum core
- Inductance range from 1.1 μ H to 155 μ H
- Current range from 0.68 A to 9.5 A
- 10.5 mm x 10.3 mm footprint surface mount package in a 3.0 mm height
- Ferrite core material
- Halogen free, lead free, RoHS compliant

Applications

- LED/LCD backlighting
- High definition televisions (HDTV)
- Server and desktop power supplies
- Portable electronics
- Notebook and laptop regulators
- Graphics cards and battery powered systems
- Point-of-load (POL) modules
- Printers and peripherals

Environmental Data

- Storage temperature range (Component): -40 °C to +125 °C
- Operating temperature range: -40 °C to +125 °C (ambient plus self-temperature rise)
- Solder reflow temperature: J-STD-020D compliant



Product Specifications

Part Number ⁵	OCL ¹ (μ H) $\pm 30\%$	I_{rms}^2 (A)	I_{sat}^3 (A)	DCR (m Ω) typical @ 20°C	DCR (m Ω) maximum @ 20°C	K-factor ⁴
DR1030-1R1-R	1.1	7.0	9.5	6.5	7.9	22
DR1030-1R8-R	1.9	5.9	7.4	9.1	11.0	17
DR1030-2R8-R	2.8	5.1	6.08	12.1	14.5	14
DR1030-3R9-R	4.0	4.3	5.1	16.4	20.0	12
DR1030-5R2-R	5.2	3.7	4.75	22.9	27.5	10
DR1030-6R8-R	6.8	3.5	3.9	24.9	30.0	9
DR1030-8R2-R	8.4	3.3	3.54	28.4	34.1	8
DR1030-100-R	10.4	2.8	3.18	40.2	48.0	7
DR1030-150-R	14.8	2.3	2.66	57.3	68.8	6
DR1030-220-R	22.8	1.8	2.19	95.5	115	5
DR1030-330-R	32.4	1.6	1.81	114	136	4
DR1030-470-R	47.9	1.3	1.52	167	200	3.4
DR1030-680-R	67	1.1	1.24	253	304	2.9
DR1030-820-R	82	1.0	1.14	332	382	2.6
DR1030-101-R	100	0.86	1.05	375	450	2.4
DR1030-121-R	119	0.80	0.95	523	602	1.9
DR1030-151-R	155	0.68	0.86	590	700	1.4

1. Open Circuit Inductance (OCL) Test Parameters: 100 kHz, 0.1 Vrms, 0.0 Adc, +25 °C

2. I_{rms} : DC current for an approximate temperature rise of 40 °C without core loss. Derating is necessary for AC currents. PCB layout, trace thickness and width, air-flow, and proximity of other heat generating components will affect the temperature rise. It is recommended that the temperature of the part not exceed 125 °C under worst case operating conditions verified in the end application.

3. I_{sat} : Peak current for approximately 35% rolloff @ +25 °C

4. K-factor: K-factor: Used to determine Bp-p for core loss (see graph). $Bp-p = K * L * \Delta I$. Bp-p: (mT), K: (K-factor from table), L: (Inductance in μ H), ΔI (Peak to peak ripple current in Amps).

5. Part Number Definition: DR1030-xxx-R

DR1030 = Product code and size
-xxx= inductance value in μ H, R= decimal point,
If no R is present then last character equals number of zeros
-R suffix = RoHS compliant

Dimensions (mm)

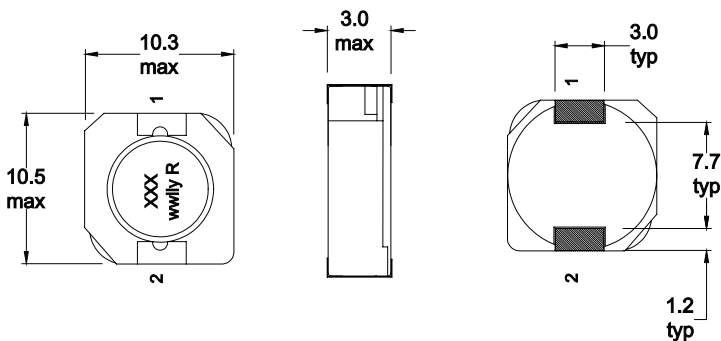

Recommended Pad Layout

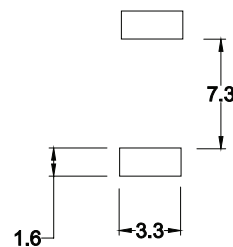

Schematic

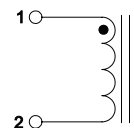

Part marking: inductance value in μ H. R = decimal point. If no R is present then last character equals number of zeroes.

wwlly = date code, R = revision level

Do not route traces or vias underneath the inductor

Packaging information (mm)

Supplied in tape and reel packaging , 1000 parts per 13" diameter reel

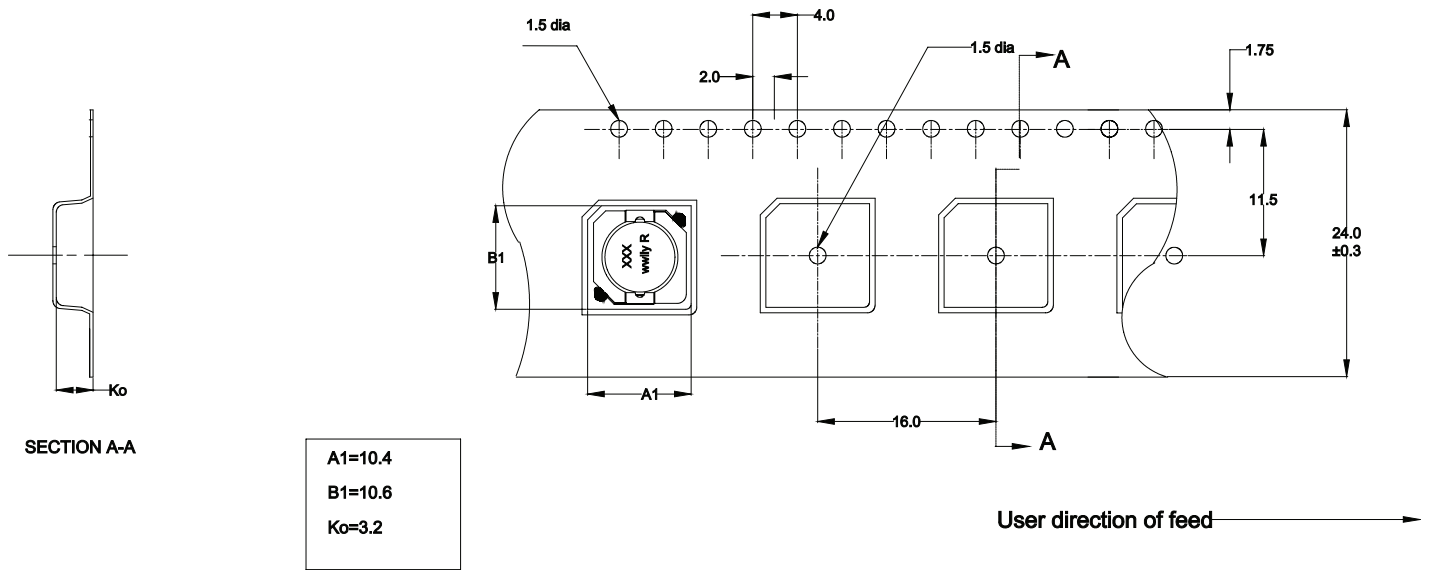

Temperature rise vs. total loss

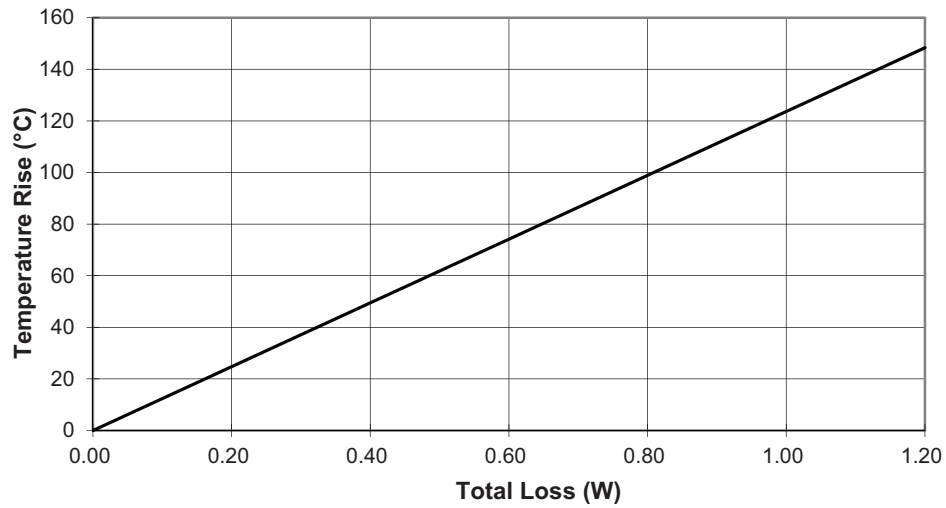

Core loss vs. B_{p-p}

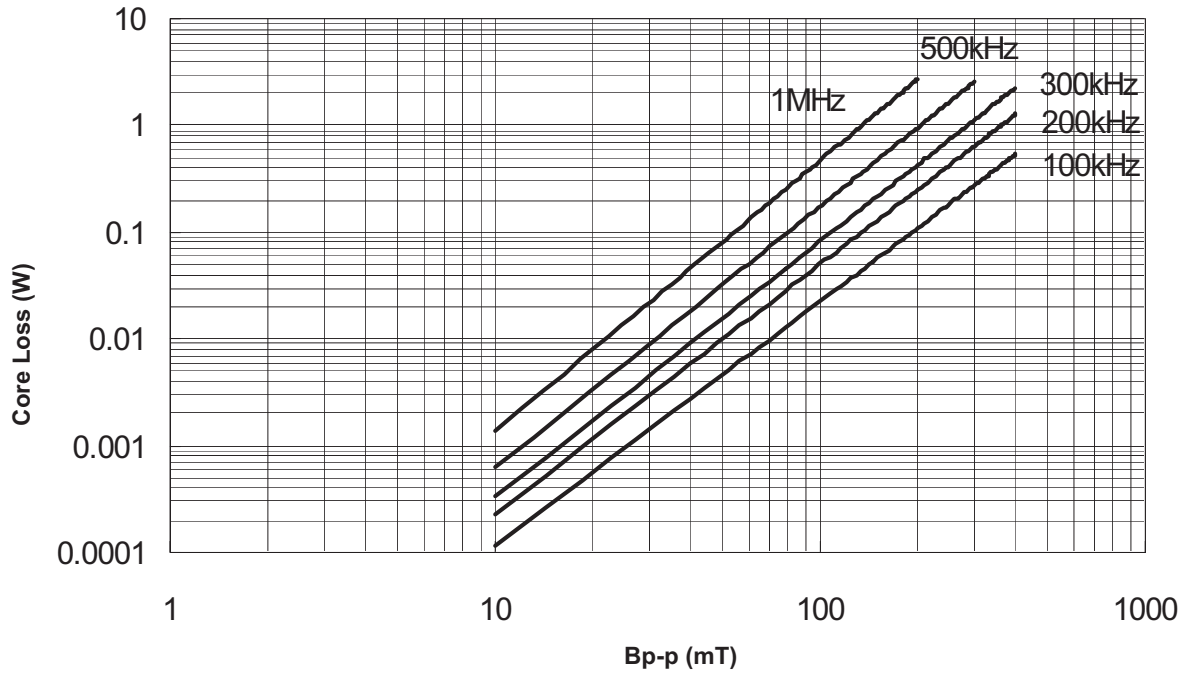

Inductance characteristics

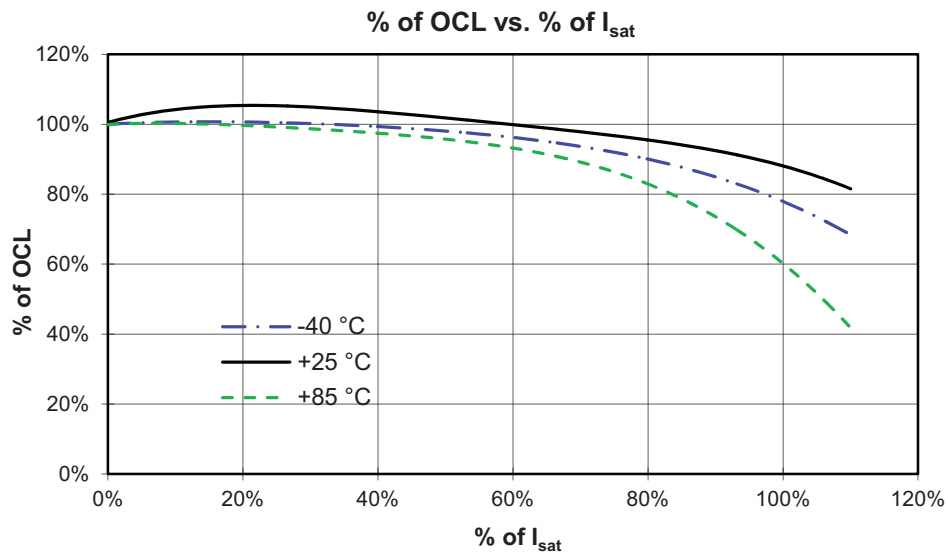

Solder reflow profile

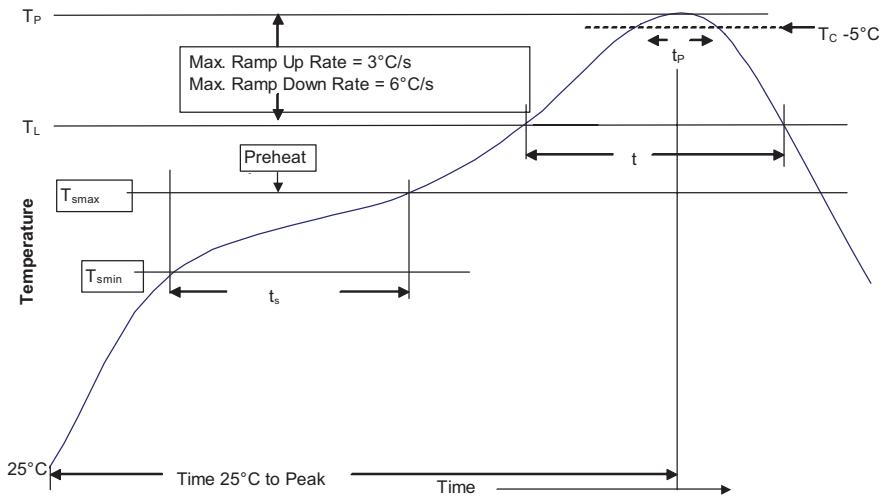

Table 1 - Standard SnPb Solder (T_C)

Package Thickness	Volume mm ³ <350	Volume mm ³ ≥350
<2.5mm)	235°C	220°C
≥2.5mm	220°C	220°C

Table 2 - Lead (Pb) Free Solder (T_C)

Package Thickness	Volume mm ³ <350	Volume mm ³ 350 - 2000	Volume mm ³ >2000
<1.6mm	260°C	260°C	260°C
1.6 - 2.5mm	260°C	250°C	245°C
>2.5mm	250°C	245°C	245°C

Reference JEDEC J-STD-020D

Profile Feature	Standard SnPb Solder	Lead (Pb) Free Solder
Preheat and Soak		
• Temperature min. (T_{smin})	100°C	150°C
• Temperature max. (T_{smax})	150°C	200°C
• Time (T_{smin} to T_{smax}) (t_s)	60-120 Seconds	60-120 Seconds
Average ramp up rate T_{smax} to T_p	3°C/ Second Max.	3°C/ Second Max.
Liquidous temperature (T_L)	183°C	217°C
Time at liquidous (t_L)	60-150 Seconds	60-150 Seconds
Peak package body temperature (T_p)*	Table 1	Table 2
Time (t_p)** within 5 °C of the specified classification temperature (T_C)	20 Seconds**	30 Seconds**
Average ramp-down rate (T_p to T_{smax})	6°C/ Second Max.	6°C/ Second Max.
Time 25°C to Peak Temperature	6 Minutes Max.	8 Minutes Max.

* Tolerance for peak profile temperature (T_p) is defined as a supplier minimum and a user maximum.
 ** Tolerance for time at peak profile temperature (t_p) is defined as a supplier minimum and a user maximum.

Life Support Policy: Eaton does not authorize the use of any of its products for use in life support devices or systems without the express written approval of an officer of the Company. Life support systems are devices which support or sustain life, and whose failure to perform, when properly used in accordance with instructions for use provided in the labeling, can be reasonably expected to result in significant injury to the user.

Eaton reserves the right, without notice, to change design or construction of any products and to discontinue or limit distribution of any products. Eaton also reserves the right to change or update, without notice, any technical information contained in this bulletin.

Eaton
Electronics Division
 1000 Eaton Boulevard
 Cleveland, OH 44122
 United States
 www.eaton.com/elx

© 2016 Eaton
 All Rights Reserved
 Printed in USA
 Publication No. 4132
 April 2016

Eaton is a registered trademark.
 All other trademarks are property of their respective owners.

Looking for pricing, stock, or lifecycle information?

Click below to explore more details on WIN SOURCE:

 [View DR1030-121-R on WIN SOURCE](#)

 [Eaton Bussmann Information](#)

Optimize Your Supply Chain with WIN SOURCE Solutions

-  Global Sourcing Solution
-  Obsolete Management
-  Cost Control Management
-  Shortage Management
-  Alternative Solution
-  Excess Inventory Management