



**THE DATASHEET OF
F1827DH1000**



THE GLOBAL EXPERT
IN **SOLID STATE**
POWER SWITCHING
TECHNOLOGY



■ Motor Controls



■ Power Supplies



■ Motor Generator Exciters



crydom[®]
Power Modules

crydom[®]

Crydom has a distinguished record of providing advanced, high quality products with timely delivery and competitive pricing. Your success in today's fast-paced global markets

hinges on working with suppliers who respond quickly and appropriately to your every need.

In addition to an extensive selection catalog off-the-shelf items, Crydom offers custom-designed power switching modules. Fact is we specialize in satisfying the most demanding environmental and performance requirements our customer can devise. Give us your specs, and watch us exceed your expectations!

At Crydom's custom-built **100,000 square foot manufacturing facility**, virtually everything is accomplished in-house to assure complete control over delivery, production and above all quality. With design, development, manufacturing and management personnel under one roof, we're geared for fast response to your requirements.

In **Design Engineering**, we focus on pushing performance, reliability and quality standards ever higher. Working under a conservative design and rating philosophy, Crydom's seasoned engineering team makes extensive use of CAD to optimize design of mechanical parts.

As a result of these efforts, Crydom has acquired an impressive list of patents in power switching technology, while continuing to create new circuit and technology-related inventions as part of our ongoing R & D programs.

Once the design is solidified, **Production Engineering** is responsible for the engineering control of the techniques used throughout manufacturing. This department works closely with our design engineering group, establishes assembly processes, and oversees a comprehensive on-premises machine shop which fabricates our assembly fixtures.

As the work progresses, **Material and Production Control** employ our advanced computer system, upgraded with our customized software to keep manufacturing operations humming. The Computer system employs integral MRP and MSP capabilities to generate detailed scheduling and planning information.

Ceramic Hybrid Manufacturing also is performed in-house. Crydom manufactures all metallized ceramic substrates used in our relays – a major factor in product performance and reliability, including direct bond copper substrates.

Quality Assurance conducts ongoing product reliability verification tests, gathering precise data on the quality of our power semiconductor vendors and the silicon chips they provide. Additional tests are performed to meet specific customer burn-in requirements.



www.crydom.com

Crydom tests are exhaustive, including 100% verification at final test. After units are fully assembled, they must pass a complete set of electrical tests, which are performed twice, once prior to encapsulation and then again afterward.

Because of our dedication to quality, Crydom was one of the first American companies to achieve full certification to the demanding standards of ISO 9001. In addition, most Crydom products are approved by UL, CSA, VDE, TUV and carry the CE Mark signifying conformance with the latest European directives.

Learn how an alliance with the world leader in solid state relays and power modules can pay off for you. For details, call your authorized Crydom distributor today.

Power Modules

Power Modules are power switching/control circuit elements integrated into convenient isolated-base packages, offering a broad spectrum of commonly used Diode, SCR, or SCR/Diode circuit configurations and ratings. Used in many types of equipment by a variety of industries, they utilize Crydom's renowned advanced thermal management techniques. The modules are mechanically and thermally optimized for ease of assembly, long life and reliable operation. Significant cost savings are realized from reductions in design, volume, mounting, connection, cooling, field maintenance, parts count, acquisition and inventory costs.

Typical Applications

AC motor drive front end	Medical Electronics
Appliances	Motor controls, AC
Battery charging	Motor controls, DC
Cathodic protection	Motor starters
Converters	Power Factor Correction
Conveyors	Power supplies
DC-choppers	Reverse polarity protection
Electroplating	Traction
Elevator controls	Transportation
Heater controls	UPS systems
HVAC controls	Welding
Inverters	

Custom Designs

Crydom's Sales and Technical Support teams work closely with you to define and develop customized solutions for your unique requirements. We can help you get that competitive edge necessary to be a leader in your industry. In-house capabilities include ceramic substrate production, SMT (surface mount technology) placement/insertion robotics assembly and elevated/low temperature monitored testing. All this interprets into fast-track design, prototype preparation, test, evaluate, adjust and finalize as necessary to achieve the specified performance criteria. Upon final customer approval we can quickly gear up to meet your production schedules in our ISO9001 certified manufacturing environment.





L
15-42.5Amp
 SCR/Diode Modules
 Low Profile
 Designed for PCB Connections

Circuit Modules provide ratings up to 42.5 amps in a low profile package designed for printed circuit board connections. Available in three standard bridge circuits and an AC switch version, all models have 2500 Vrms isolation and are UL recognized under file E72445. Mounting clip available, order part no. LMC-1.

PART NUMBER IDENTIFICATION

Series	Current	Circuit Type	AC Line Voltage	Options
L	3 - 15 Amps	1 - 5	1 - 120 Vac	F - Free
	5 - 25 Amps	(See schematic diagrams)	2 - 240 Vac	Wheeling
	6 - 42.5 Amps*		3 - 280 Vac	Diode
			4 - 480 Vac	(Circuits 1, 2)

Example: L512F

* 42.5 Amp Rating Not Available In Circuit 4

ELECTRICAL SPECIFICATIONS		L3	L5	L6
I_D	Maximum DC Output Current @ $T_c = 85^\circ\text{C}$	15A	25A	42.5A
V_F	Maximum Voltage Drop @ Amps Peak	2.2V@15A	1.65V@25A	1.6V@42.5A
T_J	Operating Junction Temperature Range	-40°C to $+125^\circ\text{C}$	-40°C to $+125^\circ\text{C}$	-40°C to $+125^\circ\text{C}$
di/dt	Critical Rate of Rise of On-State Current @ $T_J=125^\circ\text{C}$	100 A/ μs	100 A/ μs	100 A/ μs
dv/dt	Critical Rate of Rise of Off-State Voltage	500 V/ μs	500 V/ μs	500 V/ μs
V_{RMS}	AC Line Input Voltage (Repetitive Peak Reverse Voltage)	120 (400 V_{RRM})	120 (400 V_{RRM})	120 (400 V_{RRM})
		240 (600 V_{RRM})	240 (600 V_{RRM})	240 (600 V_{RRM})
		280 (800 V_{RRM})	280 (800 V_{RRM})	280 (800 V_{RRM})
		480 (1200 V_{RRM})	480 (1200 V_{RRM})	480 (1200 V_{RRM})
I_{TSM}	Maximum Non-Repetitive Surge Current ($\frac{1}{2}$ Cycle, 60Hz)	225 A	300 A	600 A
I^2T	Maximum I^2T for Fusing ($t=8.3\text{ms}$)	210A ² sec	375A ² sec	1500A ² sec
I_{GT}	Maximum Required Gate Current to Trigger @ 25°C	60 mA	60 mA	80 mA
V_{GT}	Maximum Required Gate Voltage to Trigger @ 25°C	2.5V	2.5V	3.0V
$P_{G(AV)}$	Average Gate Power	0.5W	0.5W	0.5W
V_{GM}	Maximum Peak Gate Voltage (Reverse)	5.0V	5.0V	5.0V
$R_{\theta JC}$	Maximum Thermal Resistance Junction to Ceramic Base per Chip	1.25°C/W	0.9°C/W	0.7°C/W
V_{ISOL}	Isolation Voltage	2500 V_{RMS}	2500 V_{RMS}	2500 V_{RMS}

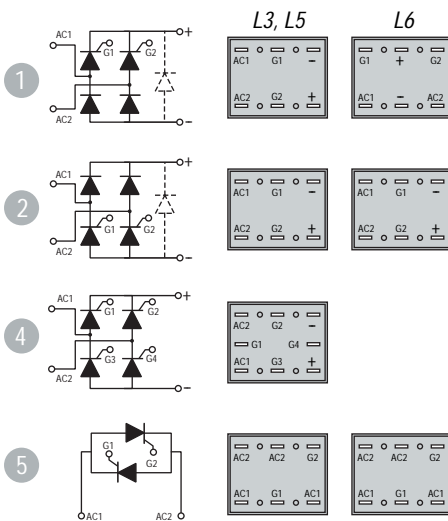

F18
25-105Amp
 Diode, SCR/Diode Modules
 Standard Package and Circuits

Modules come in an industry standard package, offering nine circuits that can be used singly or as power control building blocks. All models feature highly efficient thermal management for greatly extended cycle life and are UL recognized under file E72445.

PART NUMBER IDENTIFICATION

Series	Current	Circuit Type	AC Line Voltage
F18	27 - 25 Amps	(See schematic diagrams)	400 - 120 Vac
	42 - 40 Amps		600 - 240 Vac
	57 - 55 Amps	Example: SD	1000 - 380 Vac
	92 - 90 Amps		1200 - 480 Vac
	107 - 105 Amps		1400 - 530 Vac
			1600 - 600 Vac

Example: F1892SD1200

ELECTRICAL SPECIFICATIONS		27	42	57	92	107
I_D	Maximum DC Output Current @ $T_c = 85^\circ\text{C}$	25A	40A	55A	90A	105A
V_F	Maximum Voltage Drop @ Amps Peak	1.55V@75Apk	1.4V@120Apk	1.4V@165Apk	1.4V@270Apk	1.65V@300Apk
T_J	Operating Junction Temperature Range	-40°C to $+125^\circ\text{C}$				
di/dt	Critical Rate of Rise of On-State Current @ $T_J=125^\circ\text{C}$	100 A/ μs	100 A/ μs	100 A/ μs	100 A/ μs	100 A/ μs
dv/dt	Critical Rate of Rise of Off-State Voltage	500 V/ μs	500 V/ μs	500 V/ μs	500 V/ μs	500 V/ μs
V_{RMS}	Repetitive Peak Reverse Voltage (AC Line Input Voltage)	120 (400 V_{RRM})	120 (400 V_{RRM})	120 (400 V_{RRM})	120 (400 V_{RRM})	120 (400 V_{RRM})
		240 (600 V_{RRM})	240 (600 V_{RRM})	240 (600 V_{RRM})	240 (600 V_{RRM})	240 (600 V_{RRM})
		280 (800 V_{RRM})	280 (800 V_{RRM})	280 (800 V_{RRM})	280 (800 V_{RRM})	280 (800 V_{RRM})
		480 (1200 V_{RRM})	480 (1200 V_{RRM})	480 (1200 V_{RRM})	480 (1200 V_{RRM})	480 (1200 V_{RRM})
		530 (1400 V_{RRM})	530 (1400 V_{RRM})	530 (1400 V_{RRM})	530 (1400 V_{RRM})	530 (1400 V_{RRM})
		600 (1600 V_{RRM})	600 (1600 V_{RRM})	600 (1600 V_{RRM})	600 (1600 V_{RRM})	600 (1600 V_{RRM})
I_{TSM}	Maximum Non-Repetitive Surge Current ($\frac{1}{2}$ Cycle, 60Hz)	400A	1000A	1500A	1950A	2250A
I^2T	Maximum I^2T for Fusing ($t=8.3\text{ms}$)	670A ² sec	4150A ² sec	9350A ² sec	15800A ² sec	25000A ² sec
I_{GT}	Maximum Required Gate Current to Trigger @ 25°C	150mA	150mA	150mA	150mA	150mA
V_{GT}	Maximum Required Gate Voltage to Trigger @ 25°C	3.0V	3.0V	3.0V	3.0V	3.0V
$P_{G(AV)}$	Average Gate Power	0.5W	0.5W	0.5W	0.5W	0.5W
V_{GM}	Maximum Peak Gate Voltage (Reverse)	5.0V	5.0V	5.0V	5.0V	5.0V
$R_{\theta JC}$	Maximum Thermal Resistance Junction to Ceramic Base per Module	0.4°C/W	0.28°C/W	0.25°C/W	0.14°C/W	0.135°C/W
V_{ISOL}	Isolation Voltage	2500 V_{RMS}	2500 V_{RMS}	2500 V_{RMS}	2500 V_{RMS}	2500 V_{RMS}

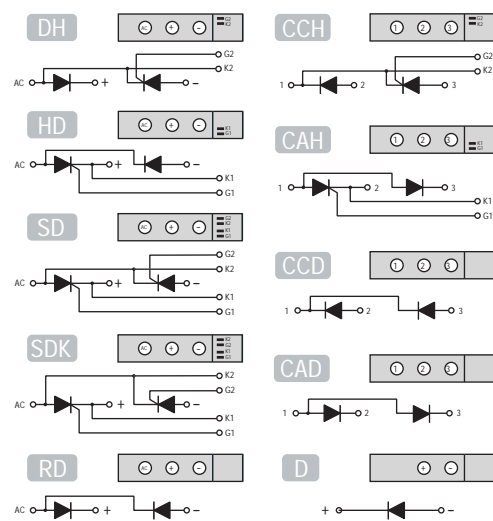



B48-2T, B48-2
35-50Amp
 Diode Modules
 Single and Three Phase Circuits
 Up to 1600 Volt Blocking Standard

Single- and three-phase diode circuits come in panel mount package that provides 2500 Vrms isolation from the terminals to the ceramic base. Available in ratings up to 1600 Volts, all models are UL recognized under file E72445.

PART NUMBER IDENTIFICATION

Series	Circuit Type	Voltage	Case Style
B48	1 - 5	B - 400 (120Vac)	-2T (Standard)
	(see schematic diagrams)	C - 600 (240Vac)	-2 With Isolation Barriers
		E - 1000 (380Vac)	
		F - 1200 (480Vac)	
		G - 1400 (530Vac)	
		H - 1600 (600Vac)	

Example: B483C-2T

ELECTRICAL SPECIFICATIONS

	SINGLE PHASE	THREE PHASE
I_D Maximum DC Output Current ($T_c = 85^\circ C$)	35A	50A
V_F Maximum Voltage Drop @ Amps Peak	1.25V @ 35A	1.35V @ 50A
T_J Operating Junction Temperature Range	-40°C to +125°C	-40°C to +125°C
V_{RRM} Repetitive Peak Reverse Voltage (Ac Line Input Voltage)	120 (400 V_{RRM})	120 (400 V_{RRM})
	240 (600 V_{RRM})	240 (600 V_{RRM})
	380 (1000 V_{RRM})	380 (1000 V_{RRM})
	480 (1200 V_{RRM})	480 (1200 V_{RRM})
	530 (1400 V_{RRM})	530 (1400 V_{RRM})
	600 (1600 V_{RRM})	600 (1600 V_{RRM})
I_{TSM} Maximum Non-Repulsive Surge Current ($1/2$ Cycle, 60Hz)	600A	600A
I^2T Maximum I^2T for Fusing ($t=8.3ms$)	1500A ² sec	1500A ² sec
R_{qJC} Maximum Thermal Resistance Junction to Ceramic Base per Chip	0.9°C/W	0.9°C/W
V_{ISOL} Isolation Voltage	2500 V_{RMS}	2500 V_{RMS}

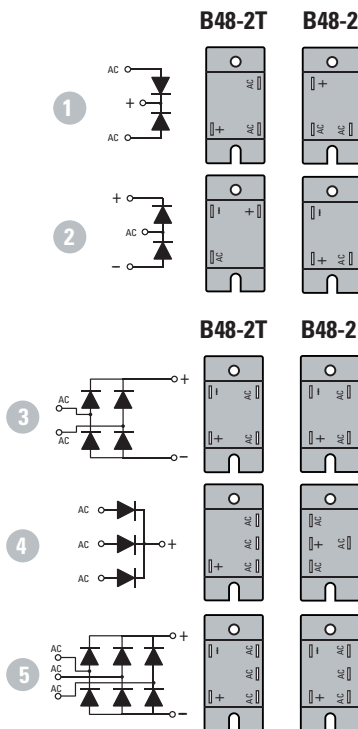

B-2T, B-2
25-42.5Amp
 SCR/Diode Modules
 Eight Standard Circuits
 AC or DC Variable Voltage Output to 15KW

Modules come in eight standard circuits and are designed to control AC and DC variable voltage output up to 15KW. The package comes with standard .250 quick-connect terminals. All modes have 2500 Vrms isolation and are UL recognized under file E72445. Optional isolation barriers are available.

PART NUMBER IDENTIFICATION

Series	Current	Circuit Type	AC Line Voltage	Options*	Case Style
B	5 - 25 Amps	1 - 8	1 - 120 Vac	F - Free Wheeling Diode (Circuits 1 & 2 Only)	-2T (Standard)
			2 - 240 Vac		-2 With Isolation Barriers
	6 - 42.5 Amps	(see schematic diagrams)	3 - 280 Vac	SE - External Suppressor	Barriers
			4 - 480 Vac	(-2T Only, Circuits 1-6 Only)	

Example: B512FSE-2T

ELECTRICAL SPECIFICATIONS

	B5	B6
I_D Maximum DC Output Current ($T_c = 85^\circ C$)	25A	42.5A
V_F Maximum Voltage Drop @ Amps Peak	1.65V @ 25A	1.6V @ 42.5A
T_J Operating Junction Temperature Range	-40°C to +125°C	-40°C to +125°C
di/dt Critical Rate of Rise of On-State Current @ $T_J=125^\circ C$	100A/ μs	100A/ μs
dv/dt Critical Rate of Rise of Off-State Voltage	500V/ μs	500V/ μs
V_{RRM} AC Line Input Voltage (Repetitive Peak Reverse Voltage)	120 (400 V_{RRM})	120 (400 V_{RRM})
	240 (600 V_{RRM})	240 (600 V_{RRM})
	280 (800 V_{RRM})	280 (800 V_{RRM})
	480 (1200 V_{RRM})	480 (1200 V_{RRM})
I_{TSM} Maximum Non-Repulsive Surge Current ($1/2$ Cycle, 60Hz)	250A	600A
I^2T Maximum I^2T for Fusing ($t=8.3ms$)	260A ² sec	1500A ² sec
I_{GT} Maximum Required Gate Current to Trigger @ 25°C	60mA	80mA
V_{GT} Maximum Required Gate Voltage to Trigger @ 25°C	2.5V	3.0V
$G(AV)$ Average Gate Power	0.5W	0.5W
P_{VGM} Maximum Peak Gate Voltage (Reverse)	5.0V	5.0V
R_{qJC} Maximum Thermal Resistance Junction to Ceramic Base per Chip	0.9°C/W	0.7°C/W
V_{ISOL} Isolation Voltage	2500 V_{RMS}	2500 V_{RMS}

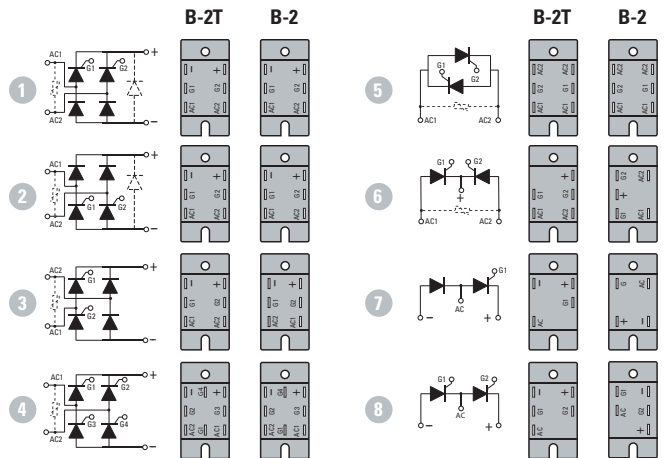

*F option available in 1 and 2 circuits only, SE option available on -2T in circuits 1-6 only.



M50 SCR/Diode Modules 50-100Amp

Over 40KW Output Capability

The M50 Series modules utilize highly efficient thermal management to provide high surge capability, long lifetime and reliable performance. Available in eight standard circuits, all models come in an industry standard package, provide 2500 Vrms from all terminals to the base plate and are UL recognized under file E72445.

PART NUMBER IDENTIFICATION

Series	Current	Circuit Type	AC Line Voltage	Options*
M50	50 - 50 Amps	1 - 8	1 - 120 Vac	F - Free Wheeling Diode
	100 - 100 Amps	(see schematic diagrams)	2 - 240 Vac	V - External Suppressor
			3 - 280 Vac	
			4 - 380 Vac	
			5 - 480 Vac	

Example: M505012FV

ELECTRICAL SPECIFICATIONS

	M5050	M50100
I_D Maximum DC Output Current ($T_c = 85^\circ\text{C}$)	50A	100A
V_F Maximum Voltage Drop @ Amps Peak	1.7V @ 50A	1.4V @ 100A
T_J Operating Junction Temperature Range	-40°C to $+125^\circ\text{C}$	-40°C to $+125^\circ\text{C}$
di/dt Critical Rate of Rise of On-State Current @ $T_J=125^\circ\text{C}$	100A/ μs	100A/ μs
dv/dt Critical Rate of Rise of Off-State Voltage	500V/ μs	500V/ μs
V_{RMS} AC Line Input Voltage (Repetitive Peak Reverse Voltage)	120 (400 V_{RRM})	120 (400 V_{RRM})
	240 (600 V_{RRM})	240 (600 V_{RRM})
	280 (800 V_{RRM})	280 (800 V_{RRM})
	380 (1000 V_{RRM})	380 (1000 V_{RRM})
	480 (1200 V_{RRM})	480 (1200 V_{RRM})
I_{TSM} Maximum Non-Repetitive Surge Current ($1/2$ Cycle, 60Hz)	600A	1500A
I^2T Maximum I^2T for Fusing ($t=8.3\text{ms}$)	1500 $\text{A}^2 \text{sec}$	9350 $\text{A}^2 \text{sec}$
I_{GT} Maximum Required Gate Current to Trigger @ 25°C	150mA	150mA
V_{GT} Maximum Required Gate Voltage to Trigger @ 25°C	3.0V	3.0V
$P_{G(AV)}$ Average Gate Power	0.5W	0.5W
V_{GM} Maximum Peak Gate Voltage (Reverse)	5.0V	5.0V
R_{qJC} Maximum Thermal Resistance Junction to Ceramic Base per Chip	0.7 $^\circ\text{C/W}$	0.36 $^\circ\text{C/W}$
V_{ISOL} Isolation Voltage	2500 V_{RMS}	2500 V_{RMS}

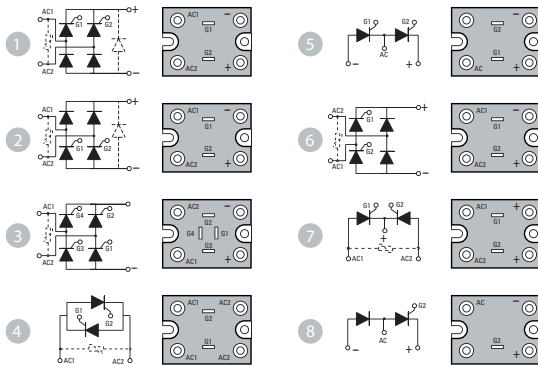

*F option available in 1 and 2 circuits only, V option available in circuits 1,2,3,4,6 and 7 only.



M50 Diode Modules 60-100Amp

High Surge Current Rectifier Circuits
Up to 1600 Volt Blocking Standard

Single- and three-phase diode circuits incorporate highly efficient thermal management to provide high surge capability, extended life, and reliable performance. Available in five circuits, all models come in an industry standard package, provide 2500 Vrms from all terminals to the baseplate, and are UL recognized under file E72445.

PART NUMBER IDENTIFICATION

Series	Current	Circuit Type	Voltage	
M50	60 - 60 Amps	(see schematic diagrams)	400 (120Vac)	1200 (480Vac)
	100 - 100 Amps		600 (240Vac)	1400 (530Vac)
	Example: TB		1000 (380Vac)	1600 (600Vac)

Example: M50100TB1200

ELECTRICAL SPECIFICATIONS

	M5060	M50100
I_D Maximum DC Output Current ($T_c = 85^\circ\text{C}$)	60A	100A
V_F Maximum Voltage Drop @ Amps Peak	1.35V @ 60A	1.2V @ 100A
T_J Operating Junction Temperature Range	-40°C to $+125^\circ\text{C}$	-40°C to $+125^\circ\text{C}$
V_{RRM} (Repetitive Peak Reverse Voltage (AC Line))	120 (400 V_{RRM})	120 (400 V_{RRM})
	240 (600 V_{RRM})	240 (600 V_{RRM})
	380 (1000 V_{RRM})	380 (1000 V_{RRM})
	480 (1200 V_{RRM})	480 (1200 V_{RRM})
	530 (1400 V_{RRM})	530 (1400 V_{RRM})
I_{TSM} Maximum Non-Repetitive Surge Current ($1/2$ Cycle, 60Hz)	800A	1500A
I^2T Maximum I^2T for Fusing ($t=8.3\text{ms}$)	2650 $\text{A}^2 \text{sec}$	9350 $\text{A}^2 \text{sec}$
$R_{\theta JC}$ Maximum Thermal Resistance Junction to Ceramic Base per Chip	0.45 $^\circ\text{C/W}$	0.3 $^\circ\text{C/W}$
V_{ISOL} Isolation Voltage	2500 V_{RMS}	2500 V_{RMS}

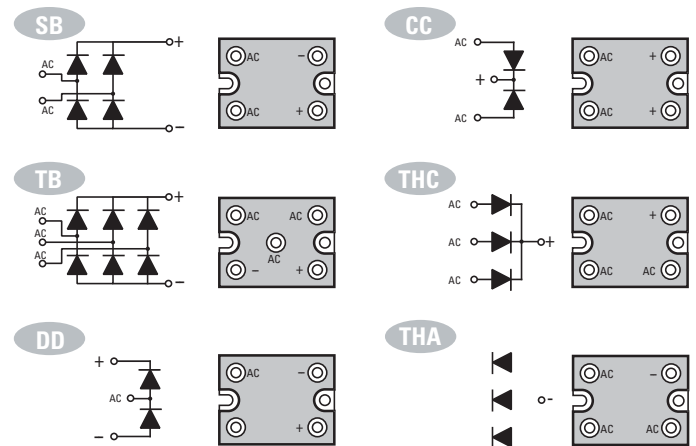



EF
50-170Amp
 Diode, SCR/Diode Modules
 High Thermal Efficiency

These circuits provide complete power control in a single package, utilizing high thermal efficiency to assure long life and reliable performance. Twelve standard models provide 2500 Vrms isolation from all terminals to ceramic base and are UL recognized under file E72445.

PART NUMBER IDENTIFICATION

Series	Current (Amps)	Circuit Type	Voltage	Options
EF	10 30 AC SW	(see schematic diagrams)	B - 400 (120 Vac)	F - Free Wheeling Diode (Circuits 1,2,16,19)
	D - 50 70 55	Example: 01	C - 500 (240 Vac)	
	E - 75 100 85		E - 1000 (380 Vac)	
	F - 100 135 110		F - 1200 (480 Vac)	
	G - 125 170 140		G - 1400 (530 Vac)	

Example: EFD02CF

ELECTRICAL SPECIFICATIONS

	D	E	F	G
I_D Maximum DC Output Current ($T_c = 85^\circ C$)	See Part Number Identification Above for Ratings of Single Phase, Three Phase and AC Switch Circuits			
V_F Maximum Voltage Drop @ Amps Peak	1.7V @ 50A	1.85V @ 75A	1.4V @ 100A	1.55V @ 125A
T_J Operating Junction Temperature Range	-40°C to +125°C		-40°C to +125°C	
di/dt Critical Rate of Rise of On-State Current @ $T_J=125^\circ C$	100A/ μs		100A/ μs	
dv/dt Critical Rate of Rise of Off-State Voltage	500V/ μs		500V/ μs	
V_{RRM} Repetitive Peak Reverse Voltage (AC Line)	120 (400 V_{RRM}) 240 (600 V_{RRM}) 380 (1000 V_{RRM}) 480 (1200 V_{RRM}) 530 (1400 V_{RRM})		120 (400 V_{RRM}) 240 (600 V_{RRM}) 380 (1000 V_{RRM}) 480 (1200 V_{RRM}) 530 (1400 V_{RRM})	
I_{TSM} Maximum Non-Repetitive Surge Current ($1/2$ Cycle, 60Hz)	400A	600A	1500A	1950A
I^2T Maximum I^2T for Fusing ($t=8.3ms$)	670A ² sec	1500A ² sec	9340A ² sec	15800A ² sec
I_{GT} Maximum Required Gate Current to Trigger @ 25°C	60mA	80mA	150mA	150mA
V_{GT} Maximum Required Gate Voltage to Trigger @ 25°C	2.5V	3.0V	3.0V	3.0V
$P_{G(AV)}$ Average Gate Power	0.5W	0.5W	0.5W	0.5W
V_{GM} Maximum Peak Gate Voltage (Reverse)	5.0V	5.0V	5.0V	5.0V
$R_{\theta JC}$ Maximum Thermal Resistance Junction to Ceramic Base per Chip	0.8°C/W	0.7°C/W	0.36°C/W	0.3°C/W
V_{ISOL} Isolation Voltage	2500 V_{RMS}	2500 V_{RMS}	2500 V_{RMS}	2500 V_{RMS}

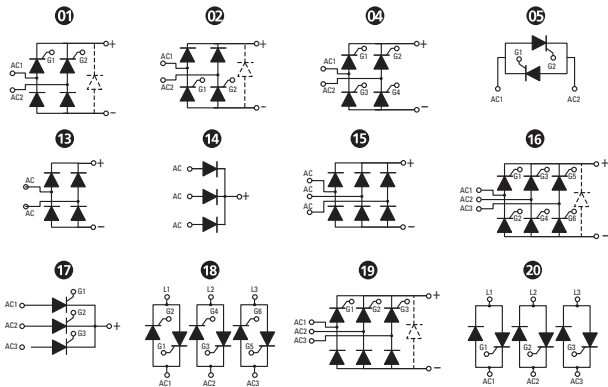

Questions?

Americas Tech Support:
 e-mail: support@crydom.com

EMEA Tech Support:
 e-mail: tech-europe@crydom.com

Americas Customer Service Center:

> +1 (877) 502-5500
 > 7am-5pm (PST), Monday-Friday
 > e-mail: sales@crydom.com

EMEA Customer Service Center:

> + 44 (0) 1202-606030
 > 8:30am-4:45pm (GMT), Monday-Thursday
 > 8:30am-3:15pm (GMT), Friday
 > e-mail: sales-europe@crydom.com

crydom[®]
Across the Globe



Crydom is an operation of Custom Sensors & Technologies (CST), a business unit of Schneider Electric.

 **AMERICAS**

 **USA/CANADA**

Crydom Inc
2320 Paseo de las Americas,
Suite 201
San Diego CA 92154

Sales Support
Tel.: +1 (877) 502 5500
Fax: +1 (619) 710 8540
sales@crydom.com

Tech Support
Tel.: +1 (877) 702 7700
support@crydom.com

 **MEXICO**

Automatismo Crouzet S.A. de C.V.

Calzada Zavaleta 2505 - C
Col Sta Cruz Buenavista
C.P. 72150 - Puebla
MEXICO
Tel.: +52 (222) 409 7000
Fax: +52 (222) 409 7810
01 800 087 6333

 **SOUTHERN AND CENTRAL AMERICAN COUNTRIES**

CST Latinoamerica
Alameda Rio Negro, 1.084-cj.A31
Centro Empresarial de Alphaville
CEP: 06454-000
Barueri - SP
BRASIL
Tel.: +55 (11) 4191 9797
Fax: +55 (11) 4191 9136
info@cst-latinoamerica.com

 **EUROPE MIDDLE EAST AFRICA**

 **UNITED KINGDOM**

Crydom SSR Ltd
Arena Business Centre
Holyrood, Close
Poole, Dorset BH17 7FJ

Sales Support
Tel.: +44 (0) 1202 606030
Fax: +44 (0) 1202 606035
sales-europe@crydom.com

Tech Support
tech-europe@crydom.com

 **AUSTRIA**

Tel.: +49 (0) 180 3000 506
Fax: +49 (0) 180 3205 227
vertrieb@crydom.com

 **BELGIUM**

Tel.: +32 (0) 2 460 4413
Fax: +32 (0) 2 461 2614
sales-europe@crydom.com

 **FRANCE**

 **0 810 123 963**
PRE APPEL LOCAL
 **0 810 057 605**
PRE APPEL LOCAL
sales-europe@crydom.com

 **GERMANY**

Tel.: +49 (0) 180 3000 506
Fax: +49 (0) 180 3205 227
vertrieb@crydom.com

 **ITALY**

Tel.: +39 (0) 2 665 99 260
Fax: +39 (0) 2 665 99 268
sales-europe@crydom.com

 **THE NETHERLANDS**

Tel.: +31 (0) 71 582 0068
Fax: +31 (0) 71 542 1648
sales-europe@crydom.com

 **SPAIN**

Tel.: +34 902 876 217
Fax: +34 902 876 219
sales-europe@crydom.com

 **PORTUGAL**

Tel.: +44 (0) 1202 606034
Fax: +44 (0) 1202 606035
sales-europe@crydom.com

 **SWITZERLAND**

Tel.: +49 (0) 180 3000 506
Fax: +49 (0) 180 3205 227
vertrieb@crydom.com

 **MIDDLE EAST, AFRICA AND OTHER EUROPEAN COUNTRIES**

Tel.: +44 (0) 1202 606030
Fax: +44 (0) 1202 606035
sales-europe@crydom.com

 **ASIA PACIFIC**

CHINA & HONG KONG Custom Sensors & Technologies (Shanghai) Ltd.

2 Floor, Innovation Building,
No.1009, Yi Shan Road,
Shanghai, 200233
Tel.: +86 (21) 2401 7766
Fax: +86 (21) 6249 0701
sales-cn@crydom.com

TAIWAN

Custom Sensors & Technologies

3F, No. 39, Ji-Hu Road
Nei-Hu Dist.
Taipei 114, Taiwan
Tel.: +886 2 8751 6388
Fax: +886 2 2657 8725
sales-tw@crydom.com

 **SOUTH KOREA**

Custom Sensors & Technologies

5F, Jeil Bldg.,
94-46 Youngdeungpo-dong 7-ga
Youngdeungpo-gu,
Seoul, 150-037
South Korea
Tel.: +82 2 2629 8312
sales-tw@crydom.com

 **INDIA**

CST Sensors India Pvt Ltd

Unit 1301 and 1302 Prestige
Meridian II
30 M.G.Road,
Bangalore - 560001
INDIA
Tel.: +91 (80) 4113 2204/05
Fax: +91 (80) 4113 2206
india@cstsensors.com

 **OTHER ASIAN AND PACIFIC COUNTRIES**

Custom Sensors & Technologies

3F, No. 39, Ji-Hu Road
Nei-Hu Dist.
Taipei 114, Taiwan
Tel.: +886 2 8751 6388
Fax: +886 2 2657 8725
sales-tw@crydom.com

CAT/CR/PM/EN

Distributed by :

Looking for pricing, stock, or lifecycle information?

Click below to explore more details on WIN SOURCE:

- [View F1827DH1000 on WIN SOURCE](#)
- [Crydom Co. Information](#)

Optimize Your Supply Chain with WIN SOURCE Solutions

- ✓ Global Sourcing Solution
- ✓ Obsolete Management
- ✓ Cost Control Management
- ✓ Shortage Management
- ✓ Alternative Solution
- ✓ Excess Inventory Management