



**THE DATASHEET OF
A22-DB-02A**



Pushbutton Switch

A22

Install in 22-dia. or 25-dia. Panel Cutout

- Easy mounting and removal of Switch Unit.
- Increase wiring efficiency with three-row mounting of Switch Unit.
- Finger protection mechanism on Switch Unit provided as a standard feature.
- Use 25-dia. ring to install in 25-dia. panel cutouts.
- Install using either round, forked crimp terminals, or ferrules.
- Wide range of shapes and colors.
- IP65 oil resistance (Non-lighted models)
EN60947-5-1

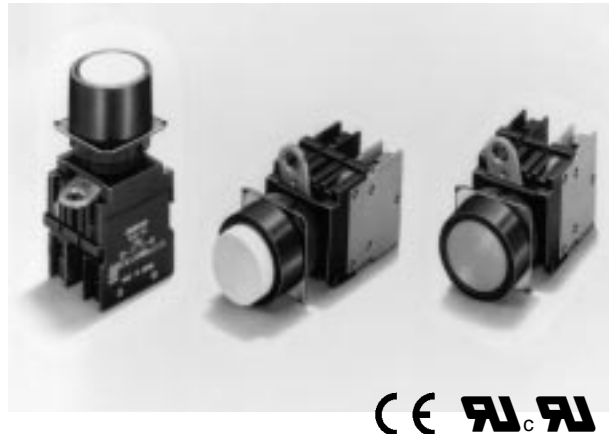

This product was manufactured at OMRON Izumo. OMRON Izumo has obtained approvals from international certification bodies for its quality system and environmental control system.

Ordering Information

■ Construction

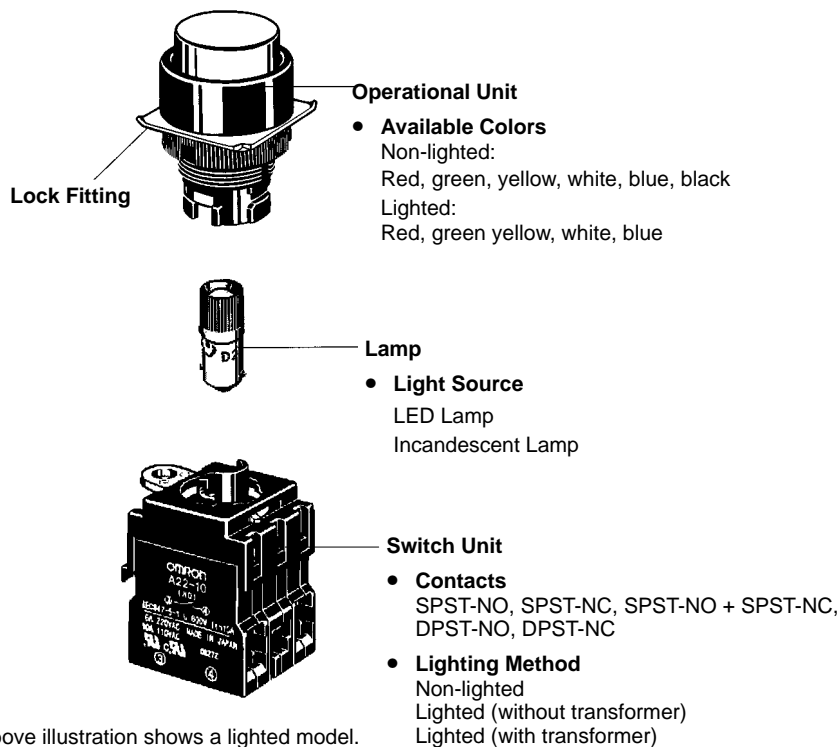

Refer to the pages 48 to 64 for specifications, accessories, installation, and precautions.

■ Model Number Legend (Completely Assembled)

Shipped as a set which includes the Operational Unit, LED (lighted type only), and Switch Unit.

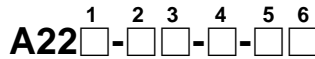

1 Lighted/Non-lighted

Code	Description
None	Non-lighted
L	Lighted

2 Flange Shape

Non-lighted	
Code	Description
F	Round/Flat
T	Round/Projection
G	Round/Full-guard
H	Round/Half-guard
C	Square/Projection
D	Square/Full-guard
S	Round/Mushroom (30-dia. head)
M	Round/Mushroom (40-dia. head)
Lighted	
T	Round/Projection
G	Round/Full-guard
H	Round/Half-guard
C	Square/Projection
D	Square/Full-guard

3 Illumination Color

Code	Description
R	Red
G	Green
Y	Yellow
W	White
A	Blue
B	Black (for non-lighted type only)

4 Light Source

Without Transformer		
Code	LED	Rated Voltage
6D	LED	6 VDC
6A		6 VAC
12A		12 VAC/DC
24A		24 VAC/DC
With Transformer		
T1	LED	110 VAC*1
T2		220 VAC*2

Note: The LED lamp (24 VAC/DC) can be lit by directly applying 110 VAC/DC (220 VAC/DC) to the lamp terminal. LED incorporates the 24-VAC/DC type.

5 Contacts

Code	Description
10	SPST-NO
01	SPST-NC
11	SPST-NO + SPST-NC
20	DPST-NO
02	DPST-NC

Note: Refer to page 48 for contact ratings.

6 Switch Action



Code	Description
M	Momentary
A	Latching

*1) Operational voltage: 95 to 115 VAC
*2) Operational voltage: 190 to 230 VAC

■ Pushbutton Switch (Completely Assembled)

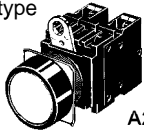
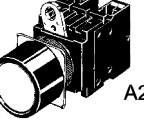
Non-lighted (Round Type)

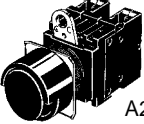
Appearance	Output	Momentary operation (self-resetting)	Latching operation (self-holding)	Illumination color
 A22-F	SPST-NO	A22-F□-10M	A22-F□-10A	Insert one of the following letters into the box □. R (red) Y (yellow) G (green) W (white) A (blue) B (black)
	SPST-NC	A22-F□-01M	A22-F□-01A	
	SPST-NO + SPST-NC	A22-F□-11M	A22-F□-11A	
	DPST-NO	A22-F□-20M	A22-F□-20A	
	DPST-NC	A22-F□-02M	A22-F□-02A	
 A22-T	SPST-NO	A22-T□-10M	A22-T□-10A	
	SPST-NC	A22-T□-01M	A22-T□-01A	
	SPST-NO + SPST-NC	A22-T□-11M	A22-T□-11A	
	DPST-NO	A22-T□-20M	A22-T□-20A	
	DPST-NC	A22-T□-02M	A22-T□-02A	
 A22-G	SPST-NO	A22-G□-10M	A22-G□-10A	
	SPST-NC	A22-G□-01M	A22-G□-01A	
	SPST-NO + SPST-NC	A22-G□-11M	A22-G□-11A	
	DPST-NO	A22-G□-20M	A22-G□-20A	
	DPST-NC	A22-G□-02M	A22-G□-02A	

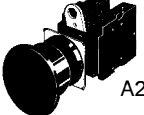
Appearance	Output	Momentary operation (self-resetting)	Latching operation (self-holding)	Illumination color
Round/Half-guard type  A22-H	SPST-NO	A22-H□-10M	A22-H□-10A	Insert one of the following letters into the box □. R (red) Y (yellow) G (green) W (white) A (blue) B (black)
	SPST-NC	A22-H□-01M	A22-H□-01A	
	SPST-NO + SPST-NC	A22-H□-11M	A22-H□-11A	
	DPST-NO	A22-H□-20M	A22-H□-20A	
	DPST-NC	A22-H□-02M	A22-H□-02A	
Small-size Mushroom type (30-dia. head)  A22-S	SPST-NO	A22-S□-10M	A22-S□-10A	
	SPST-NC	A22-S□-01M	A22-S□-01A	
	SPST-NO + SPST-NC	A22-S□-11M	A22-S□-11A	
	DPST-NO	A22-S□-20M	A22-S□-20A	
	DPST-NC	A22-S□-02M	A22-S□-02A	
Medium-size Mushroom type (40-dia head)  A22-M	SPST-NO	A22-M□-10M	A22-M□-10A	
	SPST-NC	A22-M□-01M	A22-M□-01A	
	SPST-NO + SPST-NC	A22-M□-11M	A22-M□-11A	
	DPST-NO	A22-M□-20M	A22-M□-20A	
	DPST-NC	A22-M□-02M	A22-M□-02A	

Non-lighted (Square Type)

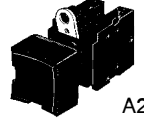
Appearance	Output	Momentary operation (self-reset)	Latching operation (self-holding)	Illumination color
Square/Projection type  A22-C	SPST-NO	A22-C□-10M	A22-C□-10A	Insert one of the following letters into the box □. R (red) Y (yellow) G (green) W (white) A (blue) B (black)
	SPST-NC	A22-C□-01M	A22-C□-01A	
	SPST-NO + SPST-NC	A22-C□-11M	A22-C□-11A	
	DPST-NO	A22-C□-20M	A22-C□-20A	
	DPST-NC	A22-C□-02M	A22-C□-02A	
Square/Guard type  A22-D	SPST-NO	A22-D□-10M	A22-D□-10A	
	SPST-NC	A22-D□-01M	A22-D□-01A	
	SPST-NO + SPST-NC	A22-D□-11M	A22-D□-11A	
	DPST-NO	A22-D□-20M	A22-D□-20A	
	DPST-NC	A22-D□-02M	A22-D□-02A	

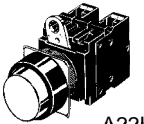

Lighted (Round Type)

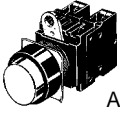
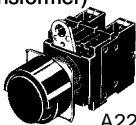

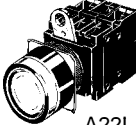
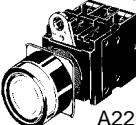
Appearance	Output	Lighting	Rated voltage	Momentary operation (self-resetting)	Latching operation (self-holding)	Illumination color
Round/Projection type LED lighting (Without transformer)  A22L-T	SPST-NO	LED	6 VDC	A22L-T□-6D-10M	A22L-T□-6D-10A	Insert one of the following letters into the box □. R (red) Y (yellow) G (green) W (white) A (blue)
			6 VAC	A22L-T□-6A-10M	A22L-T□-6A-10A	
			12 VAC/DC	A22L-T□-12A-10M	A22L-T□-12A-10A	
			24 VAC/DC	A22L-T□-24A-10M	A22L-T□-24A-10A	
	SPST-NC		6 VDC	A22L-T□-6D-01M	A22L-T□-6D-01A	
			6 VAC	A22L-T□-6A-01M	A22L-T□-6A-01A	
			12 VAC/DC	A22L-T□-12A-01M	A22L-T□-12A-01A	
			24 VAC/DC	A22L-T□-24A-01M	A22L-T□-24A-01A	
	SPST-NO + SPST-NC		6 VDC	A22L-T□-6D-11M	A22L-T□-6D-11A	
			6 VAC	A22L-T□-6A-11M	A22L-T□-6A-11A	
			12 VAC/DC	A22L-T□-12A-11M	A22L-T□-12A-11A	
			24 VAC/DC	A22L-T□-24A-11M	A22L-T□-24A-11A	
	DPST-NO		6 VDC	A22L-T□-6D-20M	A22L-T□-6D-20A	
			6 VAC	A22L-T□-6A-20M	A22L-T□-6A-20A	
			12 VAC/DC	A22L-T□-12A-20M	A22L-T□-12A-20A	
			24 VAC/DC	A22L-T□-24A-20M	A22L-T□-24A-20A	
	DPST-NC		6 VDC	A22L-T□-6D-02M	A22L-T□-6D-02A	
			6 VAC	A22L-T□-6A-02M	A22L-T□-6A-02A	
			12 VAC/DC	A22L-T□-12A-02M	A22L-T□-12A-02A	
			24 VAC/DC	A22L-T□-24A-02M	A22L-T□-24A-02A	

Appearance	Output	Lighting	Rated voltage	Momentary operation (self-resetting)	Latching operation (self-holding)	Illumination color	
Round/Projection type LED transformer lighting (With transformer)  A22L-T	SPST-NO	LED	110 VAC	A22L-T□-T1-10M	A22L-T□-T1-10A	Insert one of the following letters into the box □. R (red) Y (yellow) G (green) W (white) A (blue)	
			220 VAC	A22L-T□-T2-10M	A22L-T□-T2-10A		
	SPST-NC		110 VAC	A22L-T□-T1-01M	A22L-T□-T1-01A		
			220 VAC	A22L-T□-T2-01M	A22L-T□-T2-01A		
	SPST-NO + SPST-NC		110 VAC	A22L-T□-T1-11M	A22L-T□-T1-11A		
			220 VAC	A22L-T□-T2-11M	A22L-T□-T2-11A		
	DPST-NO		110 VAC	A22L-T□-T1-20M	A22L-T□-T1-20A		
			220 VAC	A22L-T□-T2-20M	A22L-T□-T2-20A		
	DPST-NC		110 VAC	A22L-T□-T1-02M	A22L-T□-T1-02A		
			220 VAC	A22L-T□-T2-02M	A22L-T□-T2-02A		
				220 VAC	A22L-T□-T2-02M		A22L-T□-T2-02A
	Round/Half-guard type LED lighting (Without transformer)  A22L-H		SPST-NO	6 VDC	A22L-H□-6D-10M		A22L-H□-6D-10A
6 VAC		A22L-H□-6A-10M		A22L-H□-6A-10A			
12 VAC/DC		A22L-H□-12A-10M		A22L-H□-12A-10A			
24 VAC/DC		A22L-H□-24A-10M		A22L-H□-24A-10A			
SPST-NC		6 VDC	A22L-H□-6D-01M	A22L-H□-6D-01A			
		6 VAC	A22L-H□-6A-01M	A22L-H□-6A-01A			
		12 VAC/DC	A22L-H□-12A-01M	A22L-H□-12A-01A			
		24 VAC/DC	A22L-H□-24A-01M	A22L-H□-24A-01A			
SPST-NO + SPST-NC		6 VDC	A22L-H□-6D-11M	A22L-H□-6D-11A			
		6 VAC	A22L-H□-6A-11M	A22L-H□-6A-11A			
		12 VAC/DC	A22L-H□-12A-11M	A22L-H□-12A-11A			
		24 VAC/DC	A22L-H□-24A-11M	A22L-H□-24A-11A			
DPST-NO		6 VDC	A22L-H□-6D-20M	A22L-H□-6D-20A			
		6 VAC	A22L-H□-6A-20M	A22L-H□-6A-20A			
		12 VAC/DC	A22L-H□-12A-20M	A22L-H□-12A-20A			
		24 VAC/DC	A22L-H□-24A-20M	A22L-H□-24A-20A			
DPST-NC		6 VDC	A22L-H□-6D-02M	A22L-H□-6D-02A			
		6 VAC	A22L-H□-6A-02M	A22L-H□-6A-02A			
		12 VAC/DC	A22L-H□-12A-02M	A22L-H□-12A-02A			
		24 VAC/DC	A22L-H□-24A-02M	A22L-H□-24A-02A			

Appearance	Output	Lighting	Rated voltage	Momentary operation (self-resetting)	Latching operation (self-holding)	Illumination color	
Round/Half-guard type LED transformer lighting (With transformer)  A22L-H	SPST-NO	LED	110 VAC	A22L-H□-T1-10M	A22L-H□-T1-10A	Insert one of the following letters into the box □. R (red) Y (yellow) G (green) W (white) A (blue)	
			220 VAC	A22L-H□-T2-10M	A22L-H□-T2-10A		
	SPST-NC		110 VAC	A22L-H□-T1-01M	A22L-H□-T1-01A		
			220 VAC	A22L-H□-T2-01M	A22L-H□-T2-01A		
	SPST-NO + SPST-NC		110 VAC	A22L-H□-T1-11M	A22L-H□-T1-11A		
			220 VAC	A22L-H□-T2-11M	A22L-H□-T2-11A		
	DPST-NO		110 VAC	A22L-H□-T1-20M	A22L-H□-T1-20A		
			220 VAC	A22L-H□-T2-20M	A22L-H□-T2-20A		
	DPST-NC		110 VAC	A22L-H□-T1-02M	A22L-H□-T1-02A		
			220 VAC	A22L-H□-T2-02M	A22L-H□-T2-02A		
	Round/Full-guard type LED lighting (Without transformer)  A22L-G		SPST-NO	6 VDC	A22L-G□-6D-10M		A22L-G□-6D-10A
				6 VAC	A22L-G□-6A-10M		A22L-G□-6A-10A
12 VAC/DC				A22L-G□-12A-10M	A22L-G□-12A-10A		
24 VAC/DC				A22L-G□-24A-10M	A22L-G□-24A-10A		
SPST-NC			6 VDC	A22L-G□-6D-01M	A22L-G□-6D-01A		
			6 VAC	A22L-G□-6A-01M	A22L-G□-6A-01A		
			12 VAC/DC	A22L-G□-12A-01M	A22L-G□-12A-01A		
			24 VAC/DC	A22L-G□-24A-01M	A22L-G□-24A-01A		
SPST-NO + SPST-NC			6 VDC	A22L-G□-6D-11M	A22L-G□-6D-11A		
			6 VAC	A22L-G□-6A-11M	A22L-G□-6A-11A		
			12 VAC/DC	A22L-G□-12A-11M	A22L-G□-12A-11A		
			24 VAC/DC	A22L-G□-24A-11M	A22L-G□-24A-11A		
DPST-NO			6 VDC	A22L-G□-6D-20M	A22L-G□-6D-20A		
			6 VAC	A22L-G□-6A-20M	A22L-G□-6A-20A		
		12 VAC/DC	A22L-G□-12A-20M	A22L-G□-12A-20A			
		24 VAC/DC	A22L-G□-24A-20M	A22L-G□-24A-20A			
DPST-NC		6 VDC	A22L-G□-6D-02M	A22L-G□-6D-02A			
		6 VAC	A22L-G□-6A-02M	A22L-G□-6A-02A			
		12 VAC/DC	A22L-G□-12A-02M	A22L-G□-12A-02A			
		24 VAC/DC	A22L-G□-24A-02M	A22L-G□-24A-02A			
Round/Full-guard type LED transformer lighting (With transformer)  A22L-G		SPST-NO	110 VAC	A22L-G□-T1-10M	A22L-G□-T1-10A		
			220 VAC	A22L-G□-T2-10M	A22L-G□-T2-10A		
		SPST-NC	110 VAC	A22L-G□-T1-01M	A22L-G□-T1-01A		
			220 VAC	A22L-G□-T2-01M	A22L-G□-T2-01A		
	SPST-NO + SPST-NC	110 VAC	A22L-G□-T1-11M	A22L-G□-T1-11A			
		220 VAC	A22L-G□-T2-11M	A22L-G□-T2-11A			
	DPST-NO	110 VAC	A22L-G□-T1-20M	A22L-G□-T1-20A			
		220 VAC	A22L-G□-T2-20M	A22L-G□-T2-20A			
	DPST-NC	110 VAC	A22L-G□-T1-02M	A22L-G□-T1-02A			
		220 VAC	A22L-G□-T2-02M	A22L-G□-T2-02A			

Lighted (Square Type)

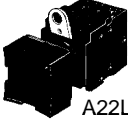
Appearance	Output	Lighting	Rated voltage	Momentary operation (self-resetting)	Latching operation (self-holding)	Illumination color
Square/Projection type LED lighting (Without transformer)  A22L-C	SPST-NO	LED	6 VDC	A22L-C□-6D-10M	A22L-C□-6D-10A	Insert one of the following letters into the box □. R (red) Y (yellow) G (green) W (white) A (blue)
			6 VAC	A22L-C□-6A-10M	A22L-C□-6A-10A	
			12 VAC/DC	A22L-C□-12A-10M	A22L-C□-12A-10A	
			24 VAC/DC	A22L-C□-24A-10M	A22L-C□-24A-10A	
	SPST-NC		6 VDC	A22L-C□-6D-01M	A22L-C□-6D-01A	
			6 VAC	A22L-C□-6A-01M	A22L-C□-6A-01A	
			12 VAC/DC	A22L-C□-12A-01M	A22L-C□-12A-01A	
			24 VAC/DC	A22L-C□-24A-01M	A22L-C□-24A-01A	
	SPST-NO + SPST-NC		6 VDC	A22L-C□-6D-11M	A22L-C□-6D-11A	
			6 VAC	A22L-C□-6A-11M	A22L-C□-6A-11A	
			12 VAC/DC	A22L-C□-12A-11M	A22L-C□-12A-11A	
			24 VAC/DC	A22L-C□-24A-11M	A22L-C□-24A-11A	
	DPST-NO		6 VDC	A22L-C□-6D-20M	A22L-C□-6D-20A	
			6 VAC	A22L-C□-6A-20M	A22L-C□-6A-20A	
			12 VAC/DC	A22L-C□-12A-20M	A22L-C□-12A-20A	
			24 VAC/DC	A22L-C□-24A-20M	A22L-C□-24A-20A	
	DPST-NC		6 VDC	A22L-C□-6D-02M	A22L-C□-6D-02A	
			6 VAC	A22L-C□-6A-02M	A22L-C□-6A-02A	
			12 VAC/DC	A22L-C□-12A-02M	A22L-C□-12A-02A	
			24 VAC/DC	A22L-C□-24A-02M	A22L-C□-24A-02A	
Square/Projection type LED transformer lighting (With transformer)  A22L-C	SPST-NO	110 VAC	A22L-C□-T1-10M	A22L-C□-T1-10A		
		220 VAC	A22L-C□-T2-10M	A22L-C□-T2-10A		
	SPST-NC	110 VAC	A22L-C□-T1-01M	A22L-C□-T1-01A		
		220 VAC	A22L-C□-T2-01M	A22L-C□-T2-01A		
	SPST-NO + SPST-NC	110 VAC	A22L-C□-T1-11M	A22L-C□-T1-11A		
		220 VAC	A22L-C□-T2-11M	A22L-C□-T2-11A		
	DPST-NO	110 VAC	A22L-C□-T1-20M	A22L-C□-T1-20A		
		220 VAC	A22L-C□-T2-20M	A22L-C□-T2-20A		
	DPST-NC	110 VAC	A22L-C□-T1-02M	A22L-C□-T1-02A		
		220 VAC	A22L-C□-T2-02M	A22L-C□-T2-02A		

Appearance	Output	Lighting	Rated voltage	Momentary operation (self-resetting)	Latching operation (self-holding)	Illumination color
Square/Full-guard type LED lighting (Without transformer)  A22L-D	SPST-NO	LED	6 VDC	A22L-D□-6D-10M	A22L-D□-6D-10A	Insert one of the following letters into the box □. R (red) Y (yellow) G (green) W (white) A (blue)
			6 VAC	A22L-D□-6A-10M	A22L-D□-6A-10A	
			12 VAC/DC	A22L-D□-12A-10M	A22L-D□-12A-10A	
			24 VAC/DC	A22L-D□-24A-10M	A22L-D□-24A-10A	
	SPST-NC		6 VDC	A22L-D□-6D-01M	A22L-D□-6D-01A	
			6 VAC	A22L-D□-6A-01M	A22L-D□-6A-01A	
			12 VAC/DC	A22L-D□-12A-01M	A22L-D□-12A-01A	
			24 VAC/DC	A22L-D□-24A-01M	A22L-D□-24A-01A	
	SPST-NO + SPST-NC		6 VDC	A22L-D□-6D-11M	A22L-D□-6D-11A	
			6 VAC	A22L-D□-6A-11M	A22L-D□-6A-11A	
			12 VAC/DC	A22L-D□-12A-11M	A22L-D□-12A-11A	
			24 VAC/DC	A22L-D□-24A-11M	A22L-D□-24A-11A	
	DPST-NO		6 VDC	A22L-D□-6D-20M	A22L-D□-6D-20A	
			6 VAC	A22L-D□-6A-20M	A22L-D□-6A-20A	
			12 VAC/DC	A22L-D□-12A-20M	A22L-D□-12A-20A	
			24 VAC/DC	A22L-D□-24A-20M	A22L-D□-24A-20A	
	DPST-NC		6 VDC	A22L-D□-6D-02M	A22L-D□-6D-02A	
			6 VAC	A22L-D□-6A-02M	A22L-D□-6A-02A	
			12 VAC/DC	A22L-D□-12A-02M	A22L-D□-12A-02A	
			24 VAC/DC	A22L-D□-24A-02M	A22L-D□-24A-02A	
Square/Full-guard type LED transformer lighting (With transformer)  A22L-D	SPST-NO	110 VAC	A22L-D□-T1-10M	A22L-D□-T1-10A		
		220 VAC	A22L-D□-T2-10M	A22L-D□-T2-10A		
	SPST-NC	110 VAC	A22L-D□-T1-01M	A22L-D□-T1-01A		
		220 VAC	A22L-D□-T2-01M	A22L-D□-T2-01A		
	SPST-NO + SPST-NC	110 VAC	A22L-D□-T1-11M	A22L-D□-T1-11A		
		220 VAC	A22L-D□-T2-11M	A22L-D□-T2-11A		
	DPST-NO	110 VAC	A22L-D□-T1-20M	A22L-D□-T1-20A		
		220 VAC	A22L-D□-T2-20M	A22L-D□-T2-20A		
	DPST-NC	110 VAC	A22L-D□-T1-02M	A22L-D□-T1-02A		
		220 VAC	A22L-D□-T2-02M	A22L-D□-T2-02A		

■ Model Number Legend (Subassembly)

The Operational Unit, Lamp, or Switch Unit can be ordered separately. Use them in combination for models that are not available as assembled units. These can also be used as inventory for maintenance parts.

Unit Combinations

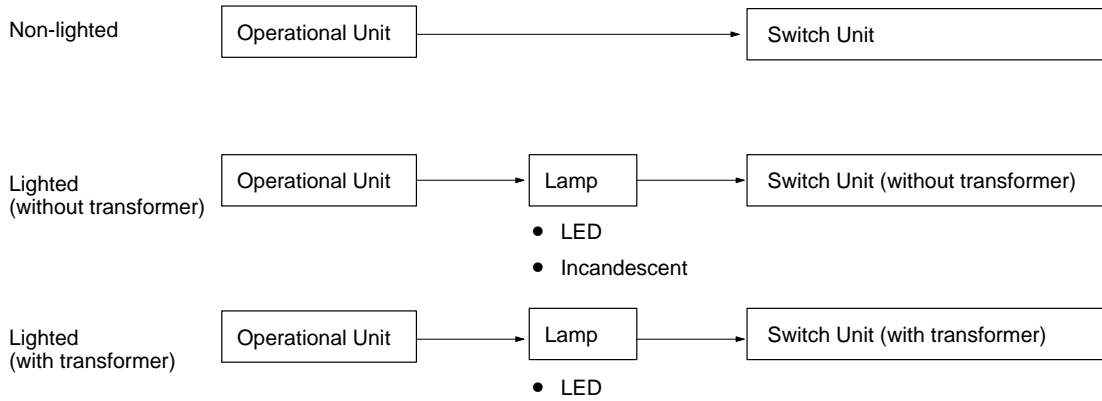

1. Operational Unit

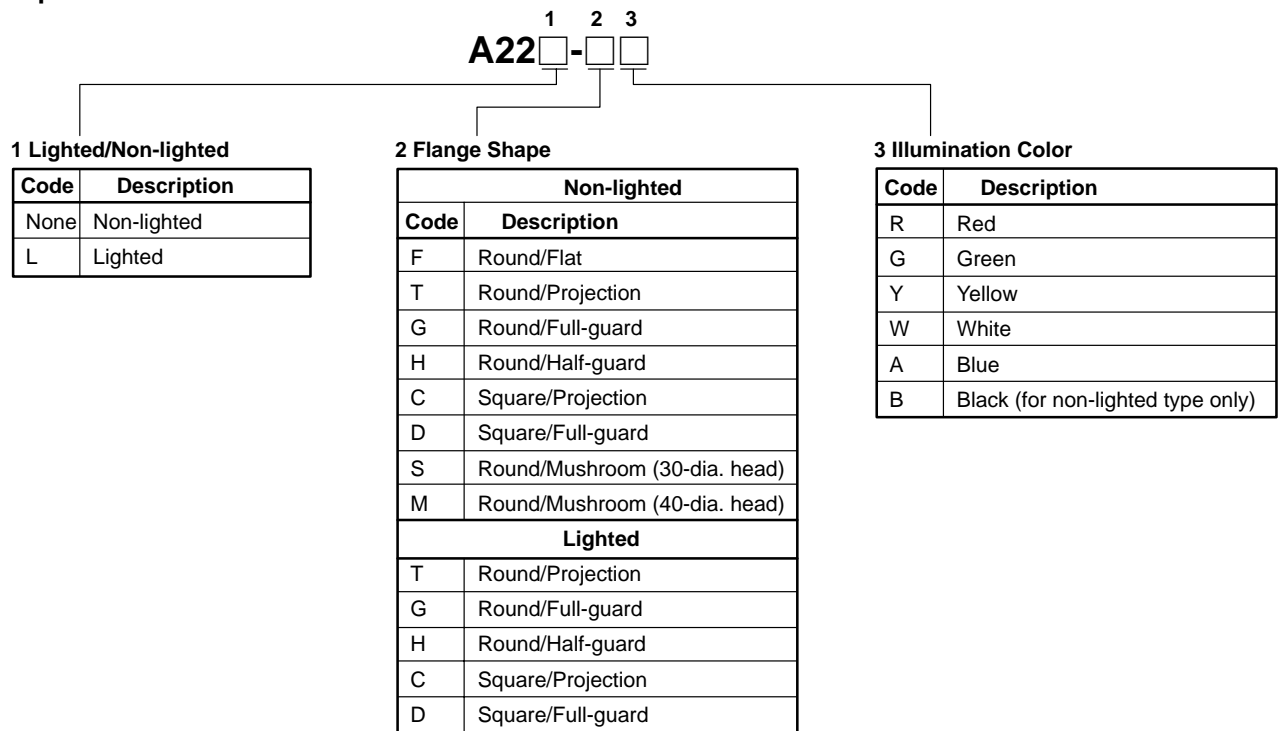

2. Lamp (Common Use)

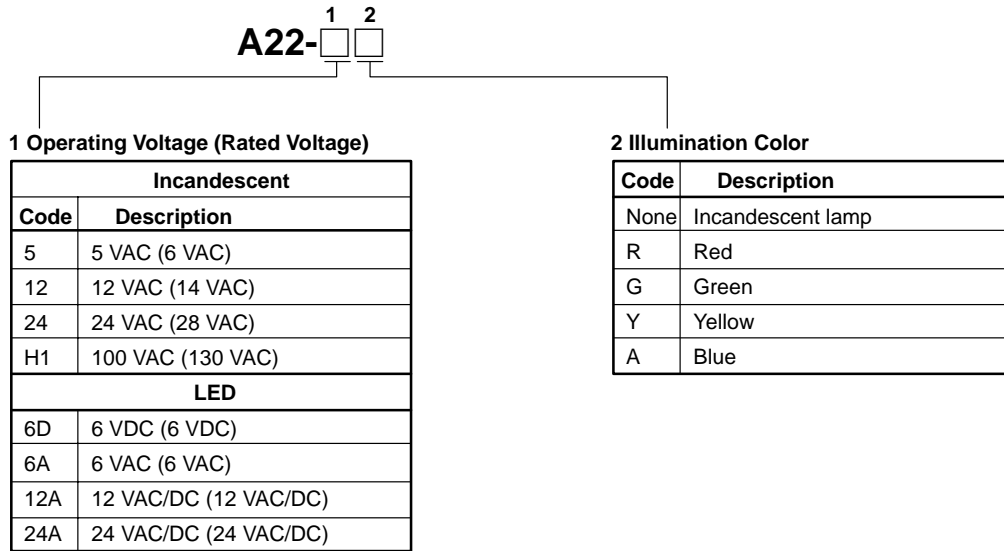

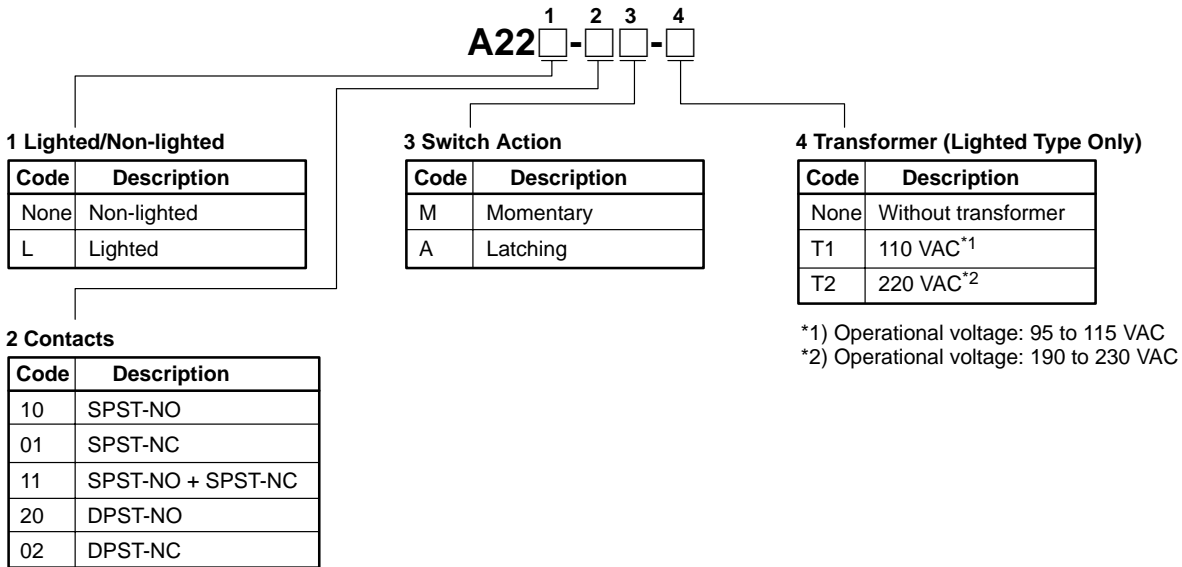

3. Switch Unit (General-purpose Load)







■ Pushbutton Switches (Subassembly)

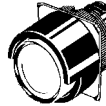

Operational Unit

Non-lighted



Color of Operational Unit	IP65 oil-resistant models			
	Flat type 	Projection type 	Full-guard type 	Half-guard type 
Red	A22-FR	A22-TR	A22-GR	A22-HR
Green	A22-FG	A22-TG	A22-GG	A22-HG
Yellow	A22-FY	A22-TY	A22-GY	A22-HY
White	A22-FW	A22-TW	A22-GW	A22-HW
Blue	A22-FA	A22-TA	A22-GA	A22-HA
Black	A22-FB	A22-TB	A22-GB	A22-HB

Color of Operational Unit	IP65 oil-resistant models			
	Square/Projection type 	Square/Full-guard type 	Round/Mushroom type (30-dia. head) 	Round/Mushroom type (40-dia. head) 
Red	A22-CR	A22-DR	A22-SR	A22-MR
Green	A22-CG	A22-DG	A22-SG	A22-MG
Yellow	A22-CY	A22-DY	A22-SY	A22-MY
White	A22-CW	A22-DW	A22-SW	A22-MW
Blue	A22-CA	A22-DA	A22-SA	A22-MA
Black	A22-CB	A22-DB	A22-SB	A22-MB

Lighted

Color of Operational Unit	IP65		
	Projection type 	Full-guard type 	Half-guard type 
Red	A22L-TR	A22L-GR	A22L-HR
Green	A22L-TG	A22L-GG	A22L-HG
Yellow	A22L-TY	A22L-GY	A22L-HY
White	A22L-TW	A22L-GW	A22L-HW
Blue	A22L-TA	A22L-GA	A22L-HA

Note: Common to incandescent lamps and LEDs.

Color of Operational Unit	IP65	
	Square/Projection 	Square/Full-guard type 
Red	A22L-CR	A22L-DR
Green	A22L-CG	A22L-DG
Yellow	A22L-CY	A22L-DY
White	A22L-CW	A22L-DW
Blue	A22L-CA	A22L-DA

Lamps

LED

Rated voltage 	6 VDC	6 VAC	12 VAC/DC	24 VAC/DC
LED light				
Red	A22-6DR	A22-6AR	A22-12AR	A22-24AR
Green	A22-6DG	A22-6AG	A22-12AG	A22-24AG
Yellow (see note 2)	A22-6DY	A22-6AY	A22-12AY	A22-24AY
Blue	A22-6DA	A22-6AA	A22-12AA	A22-24AA

- Note:** 1. For transformer lighting, use the A22-24A□.
2. Used when the Operational Unit color is yellow or white.

Incandescent



Rated voltage 	6 VAC	14 VAC	28 VAC	130 VAC
	A22-5	A22-12	A22-24	A22-H1

Switch Unit (General-purpose Load)

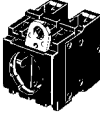
Non-lighted

Switch action 	Contacts	Model
Momentary	SPST-NO	A22-10M
	SPST-NC	A22-01M
	SPST-NO + SPST-NC	A22-11M
	DPST-NO	A22-20M
	DPST-NC	A22-02M
Latching	SPST-NO	A22-10A
	SPST-NC	A22-01A
	SPST-NO + SPST-NC	A22-11A
	DPST-NO	A22-20A
	DPST-NC	A22-02A

Lighted

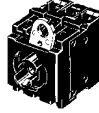
Switch Action	Contacts	Transformer circuits		
		Without transformer 	With transformer	
			110 VAC 	220 VAC 
Momentary	SPST-NO	A22L-10M	A22L-10M-T1	A22L-10M-T2
	SPST-NC	A22L-01M	A22L-01M-T1	A22L-01M-T2
	SPST-NO + SPST-NC	A22L-11M	A22L-11M-T1	A22L-11M-T2
	DPST-NO	A22L-20M	A22L-20M-T1	A22L-20M-T2
	DPST-NC	A22L-02M	A22L-02M-T1	A22L-02M-T2
Latching	SPST-NO	A22L-10A	A22L-10A-T1	A22L-10A-T2
	SPST-NC	A22L-01A	A22L-01A-T1	A22L-01A-T2
	SPST-NO + SPST-NC	A22L-11A	A22L-11A-T1	A22L-11A-T2
	DPST-NO	A22L-20A	A22L-20A-T1	A22L-20A-T2
	DPST-NC	A22L-02A	A22L-02A-T1	A22L-02A-T2

Dimensions

Note: 1. All units are in millimeters unless otherwise indicated.
 2. The following illustrations are for momentary operation.

■ Lighted/Non-lighted Pushbutton Switches

**Flat Type
A22-F**

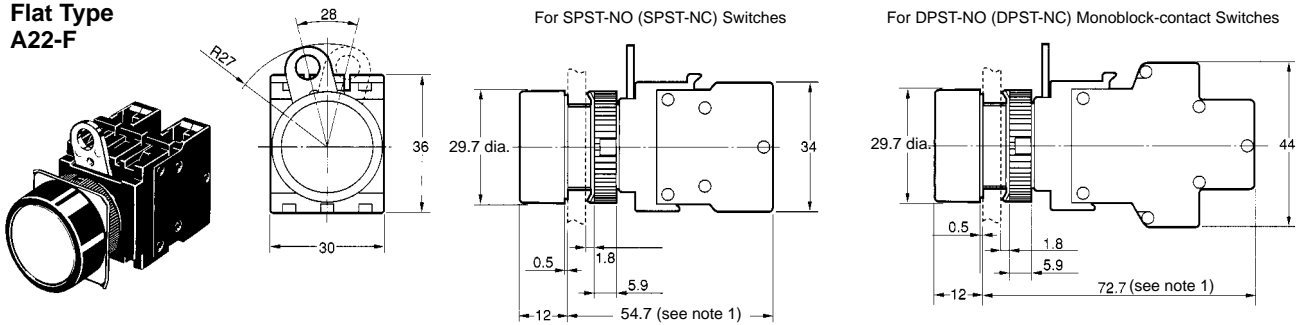

**Half-guard Type
A22-H, A22L-H**

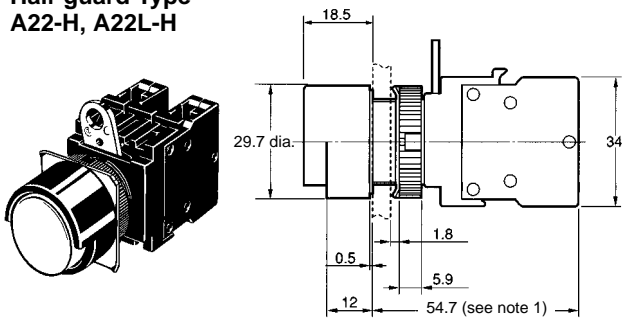

**Projection Type
A22-T, A22L-T**

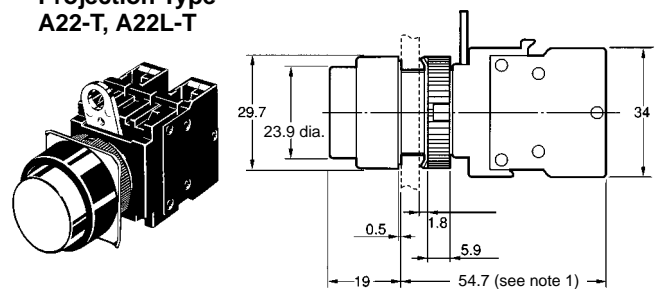

**Full-guard Type
A22-G, A22L-G**

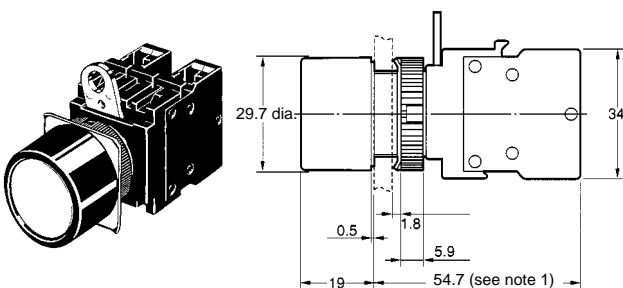

**40-dia. Mushroom Type
A22-M**

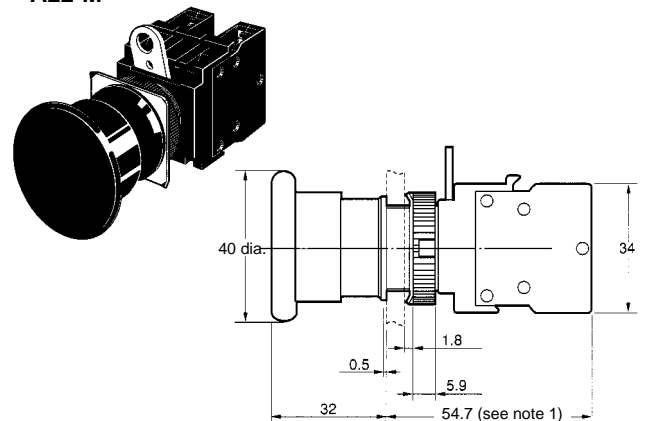

**Square/Projection Type
A22-C, A22L-C**

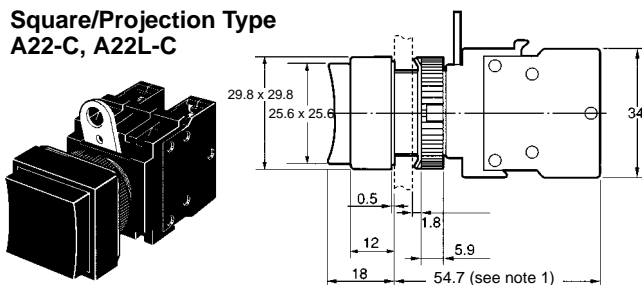

**Square Full-guard Type
A22-D, A22L-D**

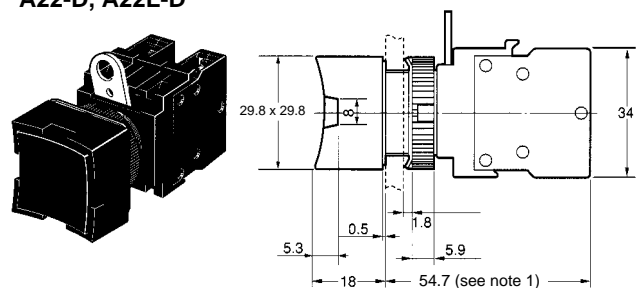

Note: 1. Latching operation models are 9.2 mm longer.
 2. Lighted models have the same dimensions as shown above, whether they are with transformers or without transformers.

■ Terminal Arrangement

Terminal Arrangement (Bottom View)

Non-lighted (SPST-NO + SPST-NC)	Lighted (SPST-NO + SPST-NC)	Non-lighted (DPST-NO + DPST-NC)

Terminal Connection

Type	Terminal connection
Non-lighted (SPST-NO + SPST-NC)	<p>Bottom view</p>
Non-lighted (DPST-NO + DPST-NC)	<p>Bottom view</p>
Lighted without transformer (SPST-NO + SPST-NC)	<p>Bottom view</p>
Lighted with transformer (SPST-NO + SPST-NC)	<p>Bottom view</p>

Panel Cutout Dimensions

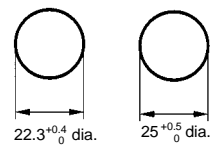



Note: When applying coating such as paint to the panel, the dimensions should be those after the application of coating. Lock fitting is provided as a standard item.

ALL DIMENSIONS SHOWN ARE IN MILLIMETERS.



To convert millimeters into inches, multiply by 0.03937. To convert grams into ounces, multiply by 0.03527.

Looking for pricing, stock, or lifecycle information?

Click below to explore more details on WIN SOURCE:

-  [View A22-DB-02A on WIN SOURCE](#)
-  [Omron Information](#)

Optimize Your Supply Chain with WIN SOURCE Solutions

-  Global Sourcing Solution
-  Obsolete Management
-  Cost Control Management
-  Shortage Management
-  Alternative Solution
-  Excess Inventory Management