



**THE DATASHEET OF
DAC7664YBT**





16-Bit, Quad Voltage Output Digital-to-Analog Converter

FEATURES

- Low Glitch: 1nV-s (typ)
- Low Power: 18mW
- Unipolar or Bipolar Operation
- Settling Time: 12μs to 0.003%
- 16-Bit Linearity and Monotonicity: -40°C to +85°C
- Programmable Reset to Mid-Scale or Zero-Scale
- Data Readback
- Double-Buffered Data Inputs
- Internal Bandgap Voltage Reference
- Power-On Reset
- 3V to 5V Logic Interface

APPLICATIONS

- Process Control
- Closed-Loop Servo Control
- Motor Control
- Data Acquisition Systems
- DAC-per-Pin Programmings

DESCRIPTION

The DAC7664 is a 16-bit, quad voltage output digital-to-analog converter (DAC) with 16-bit monotonic performance over the specified temperature range. It accepts 16-bit parallel input data, has double-buffered DAC input logic (allowing simultaneous update of all DACs), and provides a readback mode of the internal input registers. Programmable asynchronous reset clears all registers to a mid-scale code of 8000h or to a zero-scale of 0000h. The DAC7664 can operate from a single +5V supply or from +5V and -5V supplies.

Low power and small size per DAC make the DAC7664 ideal for automatic test equipment, DAC-per-pin programmers, data acquisition systems, and closed-loop servo control. The DAC7664 is available in an LQFP-64 package and is specified for operation over the -40°C to +85°C temperature range.

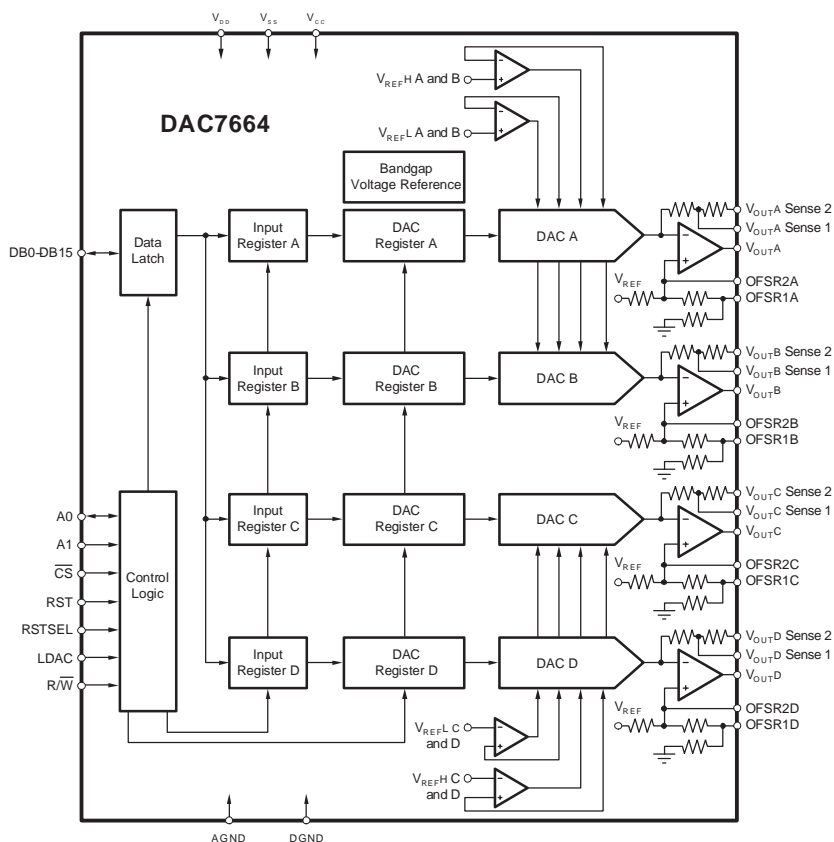

This device has ESD-CDM sensitivity and special handling precautions must be taken.



Please be aware that an important notice concerning availability, standard warranty, and use in critical applications of Texas Instruments semiconductor products and disclaimers thereto appears at the end of this data sheet.

All trademarks are the property of their respective owners.

ORDERING INFORMATION(1)

PRODUCT	PACKAGE-LEAD	PACKAGE DESIGNATOR	SPECIFIED TEMPERATURE RANGE	PACKAGE MARKING	ORDERING NUMBER	TRANSPORT MEDIA, QUANTITY
DAC7664Y	LQFP-64	PM	-40°C to +85°C	DAC7664Y	DAC7664YT	Tape and Reel, 250
					DAC7664YR	Tape and Reel, 1500
DAC7664YB	LQFP-64	PM	-40°C to +85°C	DAC7664YB	DAC7664YBT	Tape and Reel, 250
					DAC7664YBR	Tape and Reel, 1500
DAC7664YC	LQFP-64	PM	-40°C to +85°C	DAC7664YC	DAC7664YCT	Tape and Reel, 250
					DAC7664YCR	Tape and Reel, 1500

(1) For the most current package and ordering information, see the Package Option Addendum located at the end of this data sheet.

ABSOLUTE MAXIMUM RATINGS

over operating free-air temperature range unless otherwise noted(1)

	DAC7664	UNIT
IOV _{DD} , V _{CC} and V _{DD} to V _{SS}	-0.3 to 11	V
IOV _{DD} , V _{CC} and V _{DD} to GND	-0.3 to 5.5	V
Digital Input Voltage to GND	-0.3 to V _{DD} + 0.3	V
Digital Output Voltage to GND	-0.3 to V _{DD} + 0.3	V
ESD-CDM	200	V
Maximum Junction Temperature	+150	°C
Operating Temperature Range	-40 to +85	°C
Storage Temperature Range	-65 to +125	°C
Lead Temperature (soldering, 10s)	+300	°C

(1) Stresses above those listed under Absolute Maximum Ratings may cause permanent damage to the device. Exposure to absolute maximum conditions for extended periods may degrade device reliability. These are stress ratings only, and functional operation of the device at these or any other conditions beyond those specified is not implied.



This integrated circuit can be damaged by ESD. Texas Instruments recommends that all integrated circuits be handled with appropriate precautions. Failure to observe

proper handling and installation procedures can cause damage.

ESD damage can range from subtle performance degradation to complete device failure. Precision integrated circuits may be more susceptible to damage because very small parametric changes could cause the device not to meet its published specifications.

ELECTRICAL CHARACTERISTICS: $V_{SS} = 0V$

 All specifications at $T_A = T_{MIN}$ to T_{MAX} , $IOV_{DD} = V_{DD} = V_{CC} = +5V$, and $V_{SS} = 0V$, unless otherwise noted.

PARAMETER	TEST CONDITIONS	DAC7664Y			DAC7664YB			DAC7664YC			UNIT
		MIN	TYP	MAX	MIN	TYP	MAX	MIN	TYP	MAX	
Accuracy											
Linearity error			±3	±4		±2	±3		*	*	LSB
Linearity match			±4			±2			*		LSB
Differential linearity error			±2	±3		±1	±2	-1		+2	LSB
Monotonicity, T_{MIN} to T_{MAX}		14			15			16			Bit
Unipolar zero error			±1	±5		*	*		*	*	mV
Unipolar zero error drift			5	10		*	*		*	*	ppm/°C
Full-scale error			±6	±20		±4	±12.5		*	*	mV
Full-scale error drift			7	15		*	*		*	*	ppm/°C
Unipolar zero matching	Channel-to-channel matching		±3	±7		±2	±5		*	*	mV
Full-scale matching	Channel-to-channel matching		±4	±10		±2	±8		*	*	mV
Power-supply rejection ratio (PSRR)	At full-scale		10	100		*	*		*	*	ppm/V
Analog Output											
Voltage output	$R_L = 10k\Omega$	0		2.5	*		*	*		*	V
Output current		-1.25		+1.25	*		*	*		*	mA
Maximum load capacitance	No oscillation		500			*			*		pF
Short-circuit current			±20			*			*		mA
Short-circuit duration	GND or V_{CC}		Indefinite			*			*		
Dynamic Performance											
Settling time	To ±0.003%, 2.5V output step		12	15		*	*		*	*	μs
Channel-to-channel crosstalk			0.5			*			*		LSB
Digital feedthrough			2			*			*		nV-s
Output noise voltage	$f = 10kHz$		130			*			*		nV/√Hz
DAC glitch	7FFFh to 8000h or 8000h to 7FFFh		1	5		*	*		*	*	nV-s
Digital Input											
V_{IH}		$0.7 \times IOV_{DD}$				*			*		V
V_{IL}		$0.3 \times IOV_{DD}$					*		*		V
I_{IH}			±10				*		*		μA
I_{IL}			±10				*		*		μA
Digital Output											
V_{OH}	$I_{OH} = -0.8mA, IOV_{DD} = 5V$	3.6	4.5		*	*		*	*		V
V_{OL}	$I_{OL} = 1.6mA, IOV_{DD} = 5V$		0.3	0.4		*	*		*	*	V
V_{OH}	$I_{OH} = -0.4mA, IOV_{DD} = 3V$	2.4	2.6		*	*		*	*		V
V_{OL}	$I_{OL} = 0.8mA, IOV_{DD} = 3V$		0.3	0.4		*	*		*	*	V
Power Supply											
V_{DD}		+4.75	+5.0	+5.25	*	*	*	*	*	*	V
IOV_{DD}		+2.7	+5.0	+5.25	*	*	*	*	*	*	V
V_{CC}		+4.75	+5.0	+5.25	*	*	*	*	*	*	V
V_{SS}		0	0	0	*	*	*	*	*	*	V
I_{CC}			3.5	5		*	*		*	*	mA
I_{DD}			50			*			*		μA
$I(IOV_{DD})$			50			*			*		μA
Power			18	25		*	*		*		mW
Temperature Range											
Specified performance		-40		+85	*		*	*		*	°C

* specifications same as the grade to the left

ELECTRICAL CHARACTERISTICS: $V_{SS} = -5V$ All specifications at $T_A = T_{MIN}$ to T_{MAX} , $IOV_{DD} = V_{DD} = V_{CC} = +5V$, and $V_{SS} = -5V$, unless otherwise noted.

PARAMETER	TEST CONDITIONS	DAC7664Y			DAC7664YB			DAC7664YC			UNIT	
		MIN	TYP	MAX	MIN	TYP	MAX	MIN	TYP	MAX		
Accuracy												
Linearity error			±3	±4		±2	±3		*	*	LSB	
Linearity match			±4			±2			*		LSB	
Differential linearity error			±2	±3		±1	±2		-1		+2	LSB
Monotonicity, T_{MIN} to T_{MAX}			14			15			16			Bit
Bipolar zero error			±1	±5		*	*		*	*		mV
Bipolar zero error drift			5	10		*	*		*	*		ppm/°C
Full-scale error			±6	±20		±4	±12.5		*	*		mV
Full-scale error drift			7	15		*	*		*	*		ppm/°C
Bipolar zero matching	Channel-to-channel matching		±3	±7		±2	±5		*	*		mV
Full-scale matching	Channel-to-channel matching		±4	±10		±2	±8		*	*		mV
Power-supply rejection ratio (PSRR)	At full-scale		10	100		*	*		*	*		ppm/V
Analog Output												
Voltage output	$R_L = 10k\Omega$		-2.5	+2.5		*	*		*	*		V
Output current			-1.25	+1.25		*	*		*	*		mA
Maximum load capacitance	No oscillation		500			*			*			pF
Short-circuit current			-15, +30			*			*			mA
Short-circuit duration	GND or V_{CC} or V_{SS}		Indefinite			*			*			
Dynamic Performance												
Settling time	To ±0.003%, 5V output step		12	15		*	*		*	*		μs
Channel-to-channel crosstalk			0.5			*			*			LSB
Digital feedthrough			2			*			*			nV-s
Output noise voltage	$f = 10kHz$		200			*			*			nV/√Hz
DAC glitch	7FFFh to 8000h or 8000h to 7FFFh		2	7		*	*		*	*		nV-s
Digital Input												
V_{IH}			$0.7 \times IOV_{DD}$				*		*			V
V_{IL}			$0.3 \times IOV_{DD}$					*		*		V
I_{IH}			±10					*		*		μA
I_{IL}			±10					*		*		μA
Digital Output												
V_{OH}	$I_{OH} = -0.8mA, IOV_{DD} = 5V$		3.6	4.5		*	*		*	*		V
V_{OL}	$I_{OL} = 1.6mA, IOV_{DD} = 5V$			0.3	0.4		*	*		*	*	V
V_{OH}	$I_{OH} = -0.4mA, IOV_{DD} = 3V$		2.4	2.6		*	*		*	*		V
V_{OL}	$I_{OL} = 0.8mA, IOV_{DD} = 3V$			0.3	0.4		*	*		*	*	V
Power Supply												
V_{DD}			+4.75	+5.0	+5.25		*	*	*	*	*	V
IOV_{DD}			+2.7	+5.0	+5.25		*	*	*	*	*	V
V_{CC}			+4.75	+5.0	+5.25		*	*	*	*	*	V
V_{SS}			-5.25	-5.0	-4.75		*	*	*	*	*	V
I_{CC}				4	5.5		*	*		*	*	mA
I_{DD}				50			*			*		μA
$I(IOV_{DD})$				50			*			*		μA
I_{SS}			-3.5	-2.0			*	*		*	*	mA
Power				30	45		*	*		*		mW
Temperature Range												
Specified performance			-40		+85		*	*		*	*	°C

* specifications same as the grade to the left

Terminal Functions

PIN	NAME	DESCRIPTION
1	NC	No Connection
2	NC	No Connection
3	V _{SS}	Analog –5V power supply or 0V single supply
4	V _{CC}	Analog +5V power supply
5	V _{OUTA}	DAC A output voltage
6	V _{OUTA} Sense 1	Connect to V _{OUTA} for unipolar mode
7	V _{OUTA} Sense 2	Connect to V _{OUTA} for bipolar mode
8	AGND	Analog ground
9	DGND	Digital ground
10	V _{DD}	Digital +5V power supply
11	IOV _{DD}	Interface power supply
12	DB15	Data bit 15 (MSB)
13	DB14	Data bit 14
14	DB13	Data bit 13
15	NC	No connection
16	NC	No connection
17	DB12	Data bit 12
18	DB11	Data bit 11
19	DB10	Data bit 10
20	DB9	Data bit 9
21	DB8	Data bit 8
22	DB7	Data bit 7
23	DB6	Data bit 6
24	DB5	Data bit 5
25	DB4	Data bit 4
26	DB3	Data bit 3
27	DB2	Data bit 2
28	DB1	Data bit 1
29	DB0	Data bit 0
30	CS	Chip select, active low
31	R/W	Enabled by CS; controls the data read and data write.
32	LDAC	DAC register load control, rising edge triggered.
33	NC	No connection
34	NC	No connection
35	A1	Enabled by CS; in combination with A0, selects the individual DAC input registers.
36	A0	Enabled by CS; in combination with A1, selects the individual DAC input registers.
37	RST	Reset, rising edge triggered. Depending on the state of RSTSEL, the DAC registers are set to either mid-scale or zero.

PIN	NAME	DESCRIPTION
38	RSTSEL	Reset select. Determines the action of RST. If high, an RST command sets the DAC registers to mid-scale (8000h). If low, an RST command sets the DAC registers to zero (0000h).
39	NC	No connection
40	NC	No connection
41	NC	No connection
42	NC	No connection
43	NC	No connection
44	V _{OUTD} Sense 2	Connect to V _{OUTD} for bipolar mode
45	V _{OUTD} Sense 1	Connect to V _{OUTD} for unipolar mode
46	V _{OUTD}	DAC D output
47	NC	No connection
48	NC	No connection
49	Offset D Range 1	Connect to Offset D Range 2 for unipolar mode
50	Offset D Range 2	Connect to Offset D Range 1 for unipolar mode
51	Offset C Range 2	Connect to Offset C Range 1 for unipolar mode
52	Offset C Range 1	Connect to Offset C Range 2 for unipolar mode
53	V _{OUTC} Sense 2	Connect to V _{OUTC} for bipolar mode
54	V _{OUTC} Sense 1	Connect to V _{OUTC} for unipolar mode
55	V _{OUTC}	DAC C output
56	REF GND	Reference ground
57	REF GND	Reference ground
58	V _{OUTB}	DAC B output
59	V _{OUTB} Sense 1	Connect to V _{OUTB} for unipolar mode
60	V _{OUTB} Sense 2	Connect to V _{OUTB} for bipolar mode
61	Offset B Range 1	Connect to Offset B Range 2 for unipolar mode
62	Offset B Range 2	Connect to Offset B Range 1 for unipolar mode
63	Offset A Range 2	Connect to Offset A Range 1 for unipolar mode
64	Offset A Range 1	Connect to Offset A Range 2 for unipolar mode

TYPICAL CHARACTERISTICS: $V_{SS} = 0V$ (+25°C)

All specifications at $T_A = 25^\circ C$, $IOV_{DD} = V_{DD} = V_{CC} = +5V$, $V_{SS} = 0V$, representative unit, unless otherwise noted.

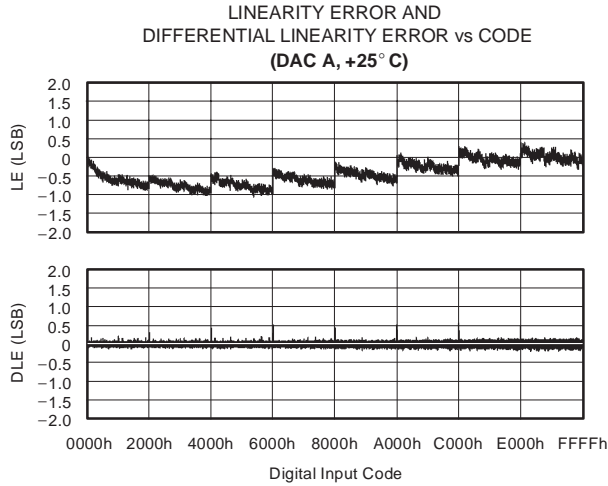

Figure 1

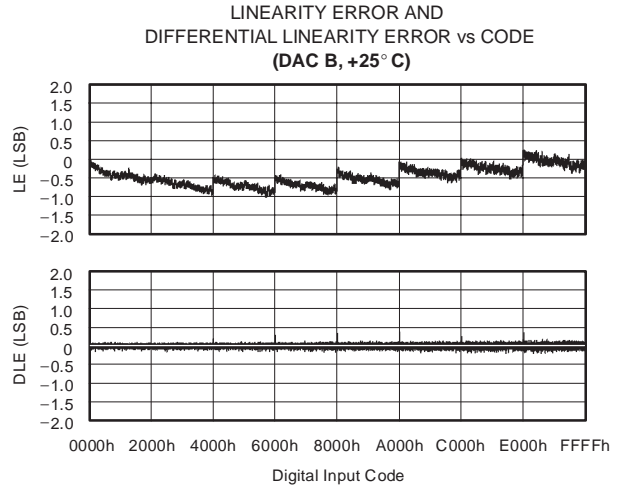

Figure 2

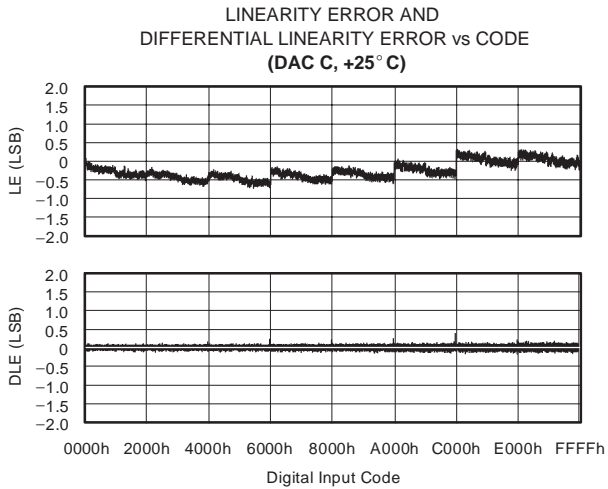

Figure 3

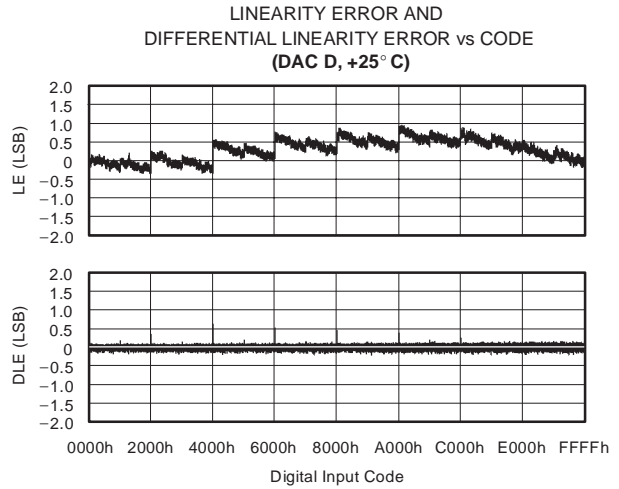

Figure 4

TYPICAL CHARACTERISTICS: $V_{SS} = 0V$ (+85°C)

All specifications at $T_A = 25^\circ C$, $IOV_{DD} = V_{DD} = V_{CC} = +5V$, $V_{SS} = 0V$, representative unit, unless otherwise noted.

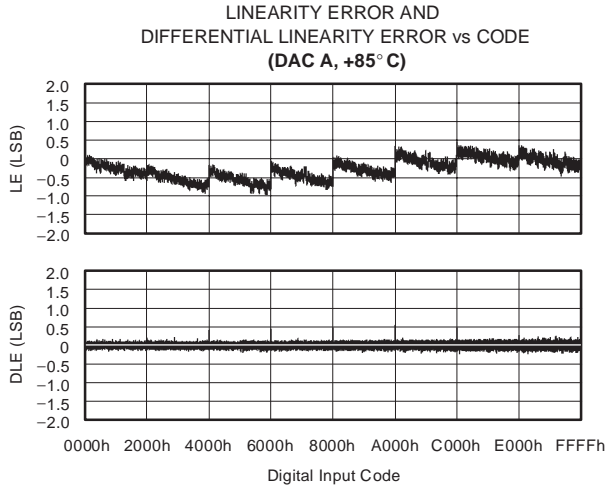

Figure 5

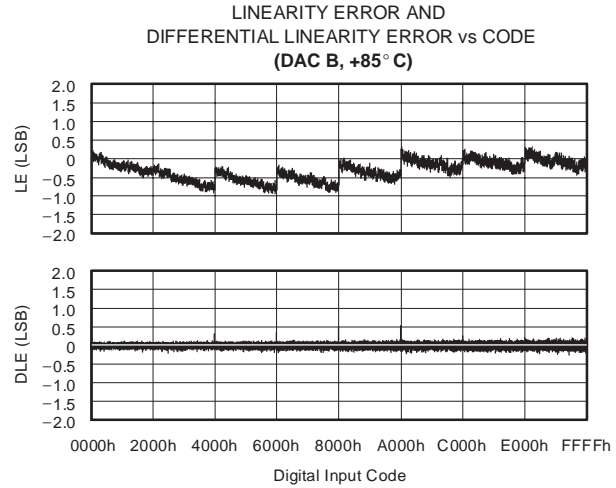

Figure 6

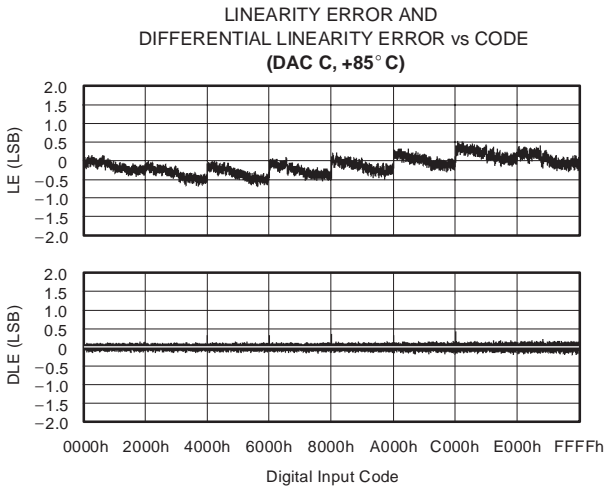

Figure 7

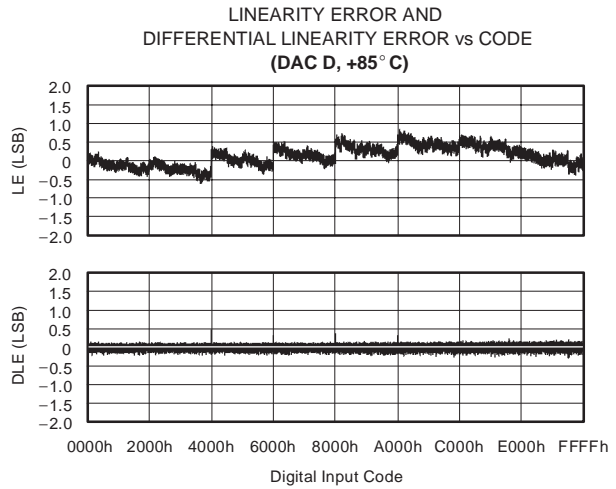

Figure 8

TYPICAL CHARACTERISTICS: $V_{SS} = 0V$ ($-40^{\circ}C$)

All specifications at $T_A = 25^{\circ}C$, $IOV_{DD} = V_{DD} = V_{CC} = +5V$, $V_{SS} = 0V$, representative unit, unless otherwise noted.

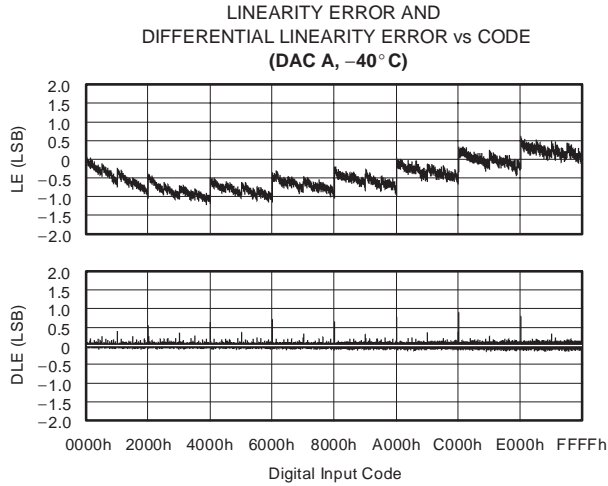

Figure 9

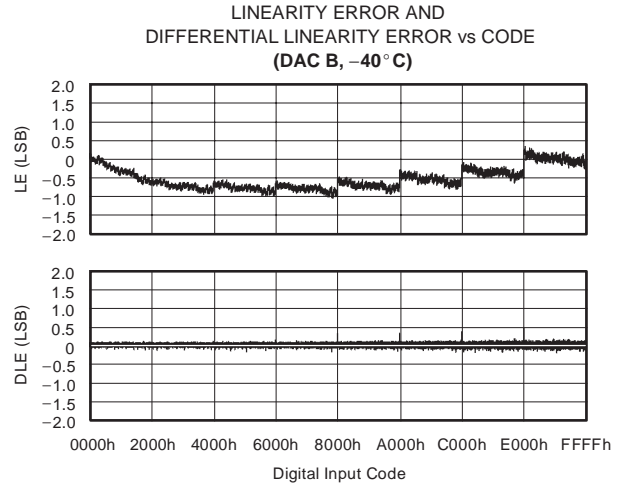

Figure 10

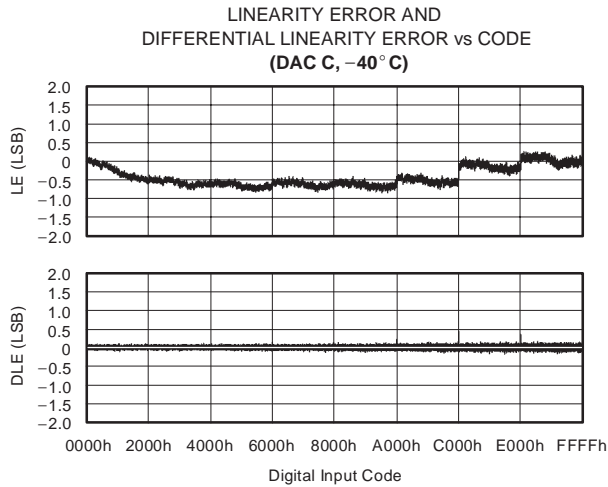

Figure 11

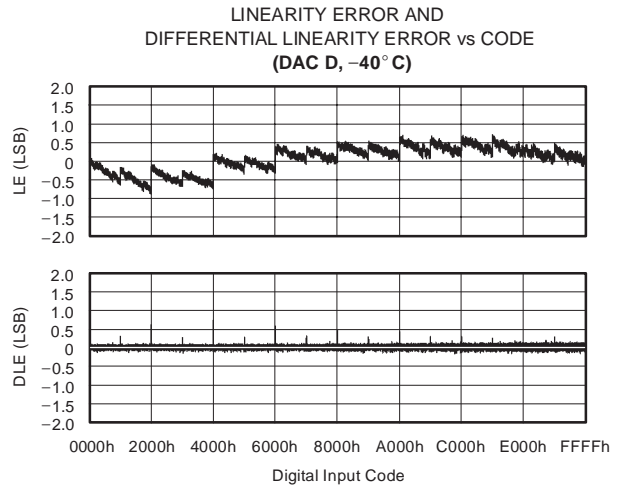

Figure 12

TYPICAL CHARACTERISTICS: $V_{SS} = 0V$

All specifications at $T_A = 25^\circ C$, $IOV_{DD} = V_{DD} = V_{CC} = +5V$, $V_{SS} = 0V$, representative unit, unless otherwise noted.

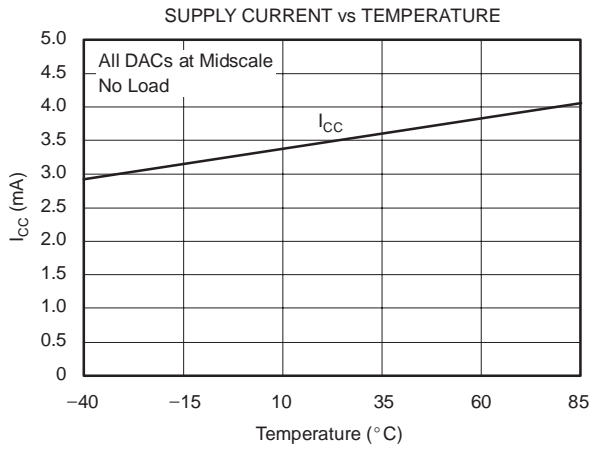

Figure 13

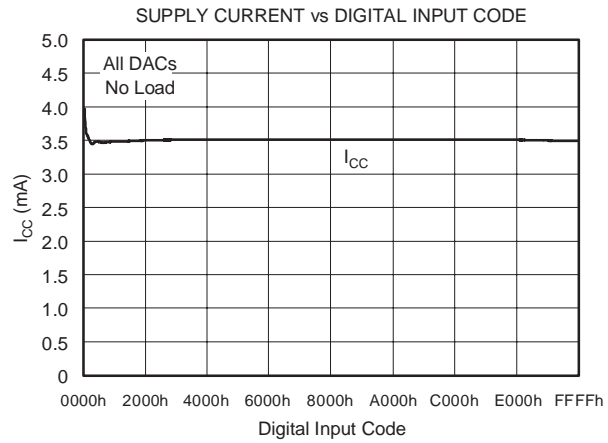

Figure 14

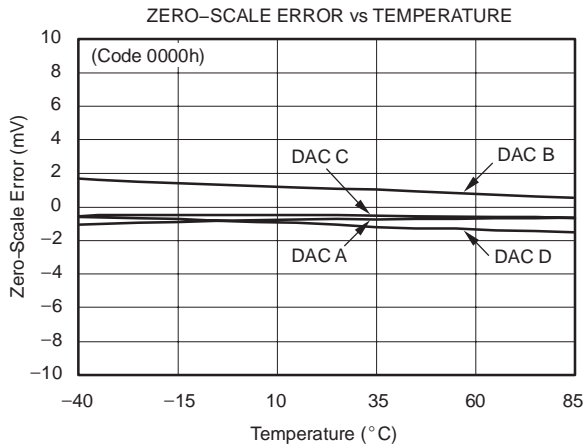

Figure 15

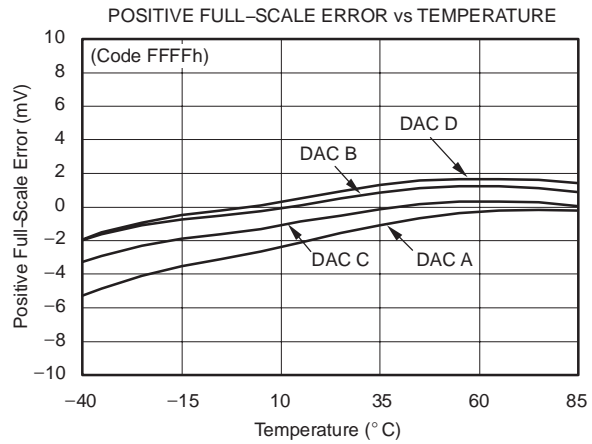

Figure 16

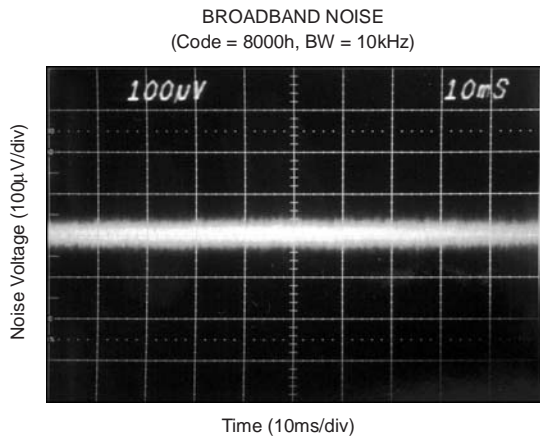

Figure 17

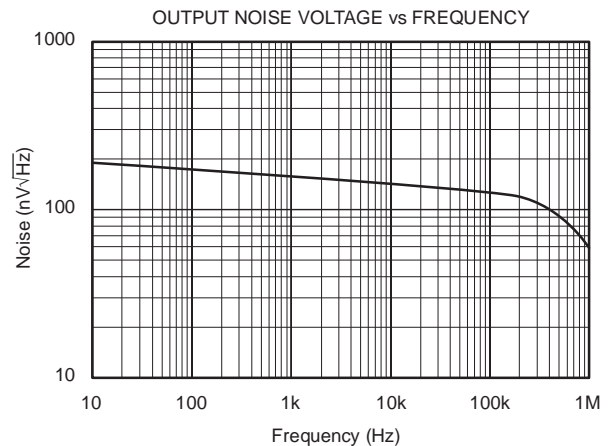

Figure 18

TYPICAL CHARACTERISTICS: $V_{SS} = 0V$ (continued)

All specifications at $T_A = 25^\circ C$, $IOV_{DD} = V_{DD} = V_{CC} = +5V$, $V_{SS} = 0V$, representative unit, unless otherwise noted.

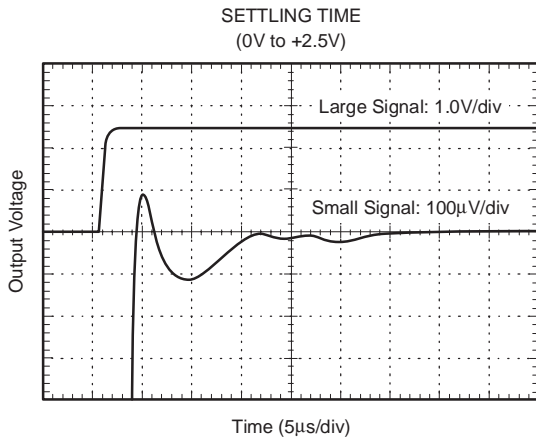

Figure 19

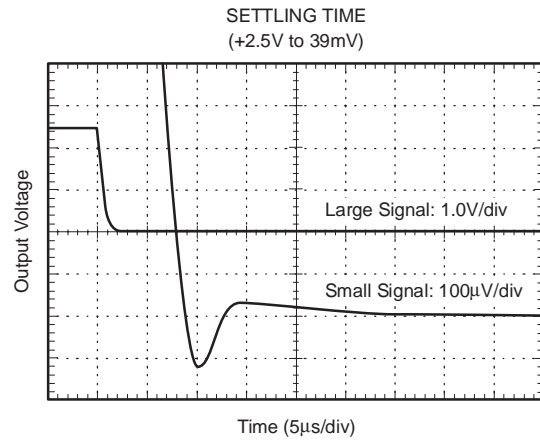

Figure 20

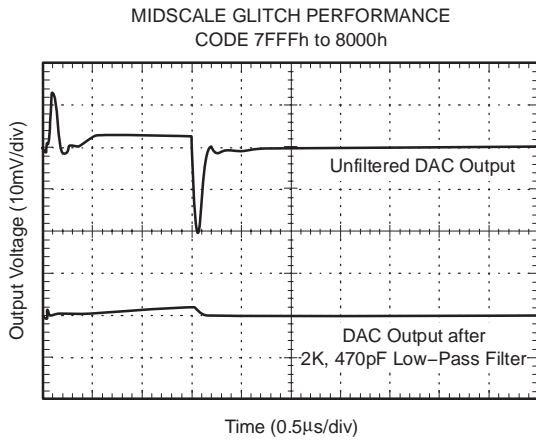

Figure 21

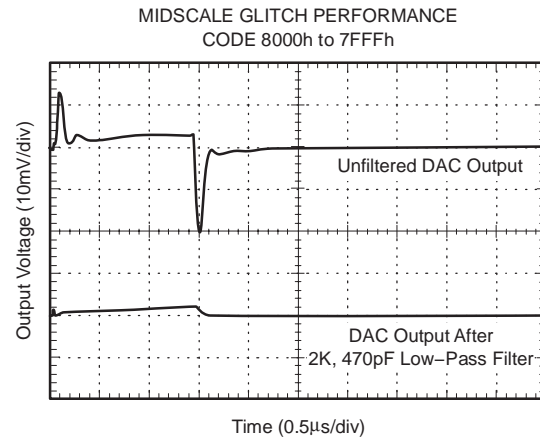

Figure 22

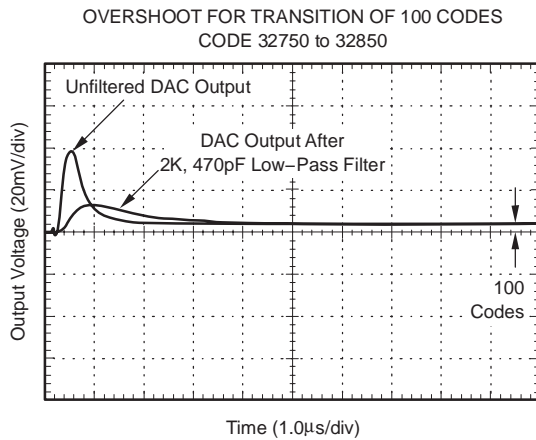

Figure 23

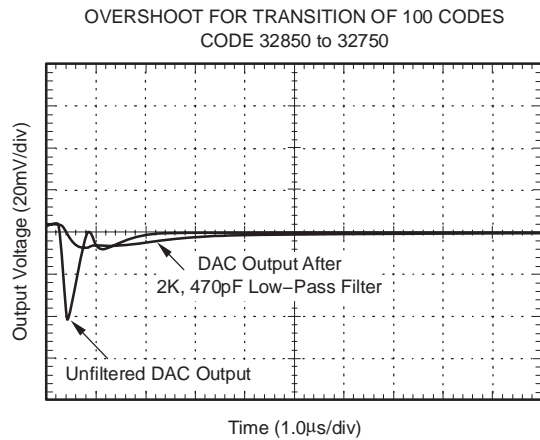

Figure 24

TYPICAL CHARACTERISTICS: $V_{SS} = 0V$ (continued)

All specifications at $T_A = 25^\circ C$, $IOV_{DD} = V_{DD} = V_{CC} = +5V$, $V_{SS} = 0V$, representative unit, unless otherwise noted.

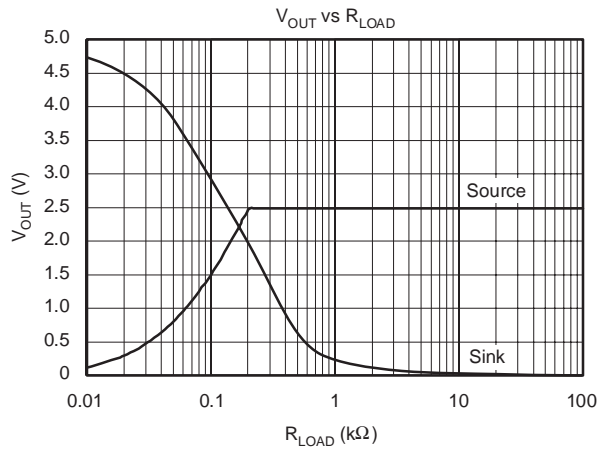

Figure 25

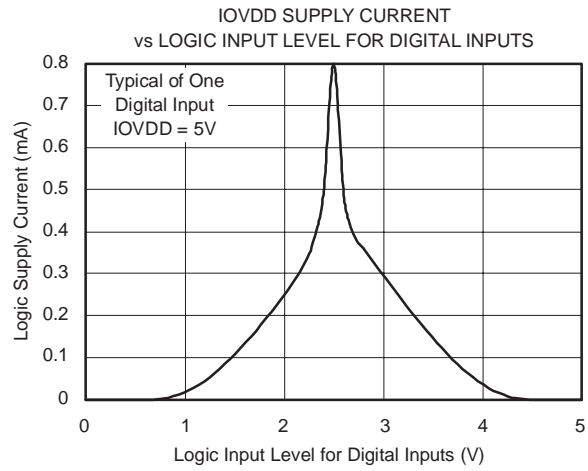

Figure 26

TYPICAL CHARACTERISTICS: $V_{SS} = -5V$ (+25°C)

All specifications at $T_A = 25^\circ C$, $IOV_{DD} = V_{DD} = V_{CC} = +5V$, $V_{SS} = -5V$, representative unit, unless otherwise noted.

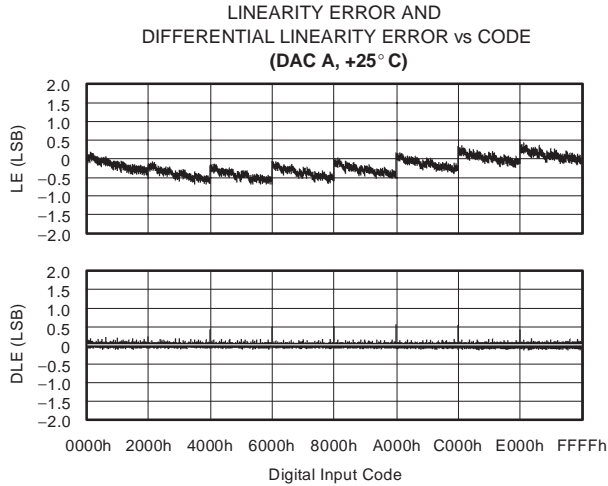

Figure 27

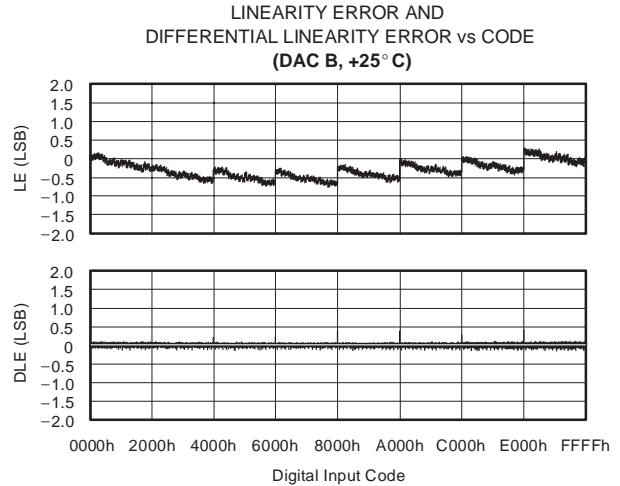

Figure 28

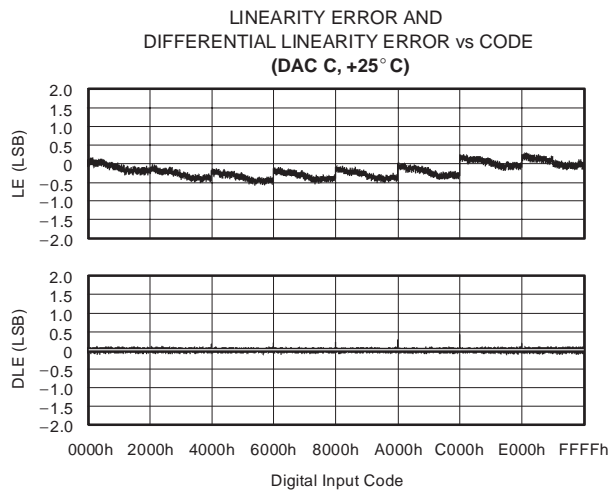

Figure 29

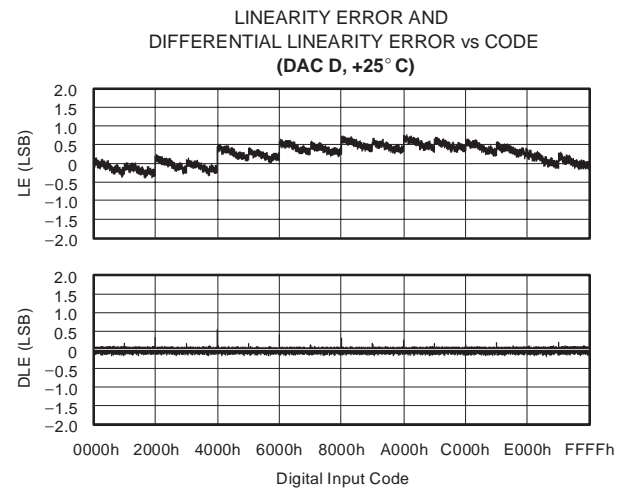

Figure 30

TYPICAL CHARACTERISTICS: $V_{SS} = -5V$ (+85°C)

All specifications at $T_A = 25^\circ C$, $IOV_{DD} = V_{DD} = V_{CC} = +5V$, $V_{SS} = -5V$, representative unit, unless otherwise noted.

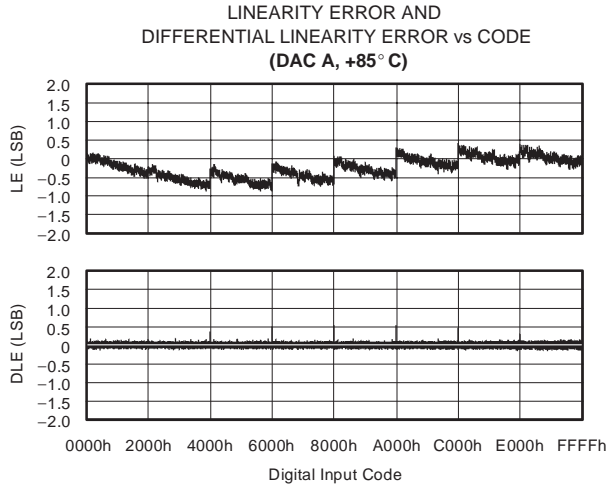

Figure 31

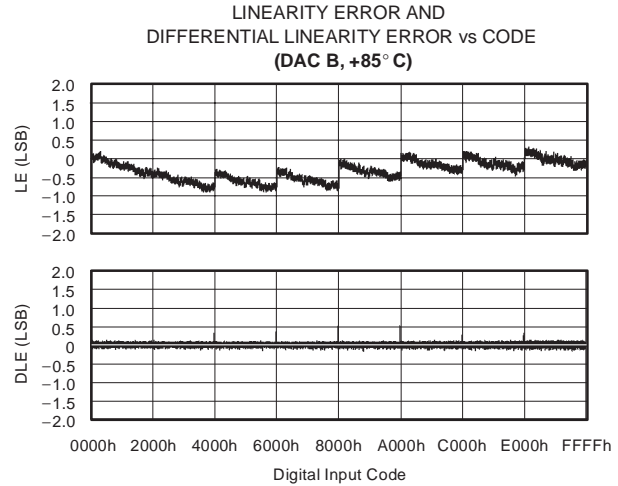

Figure 32

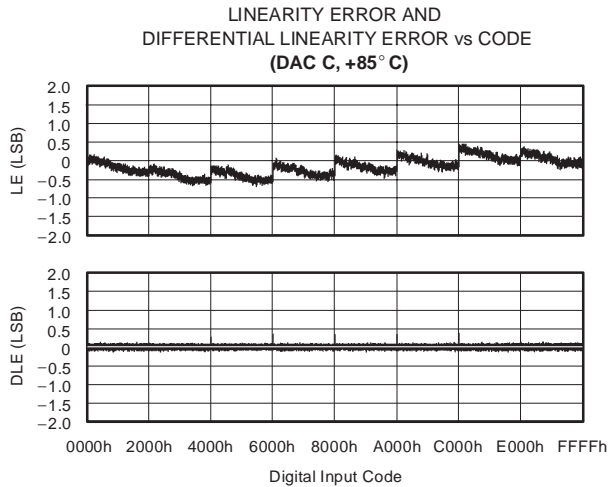

Figure 33

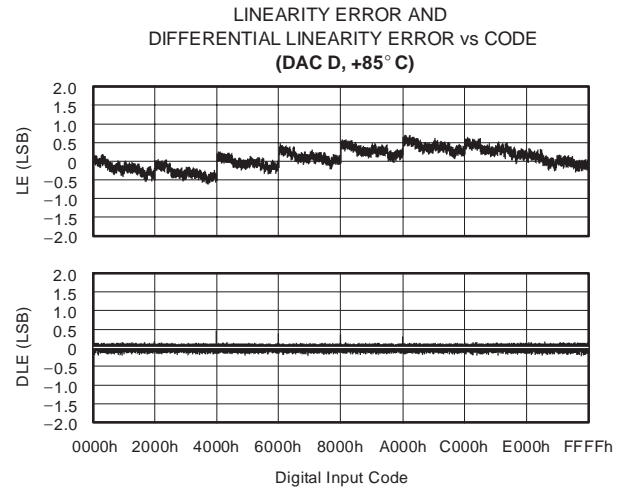

Figure 34

TYPICAL CHARACTERISTICS: $V_{SS} = -5V$ ($-40^{\circ}C$)

All specifications at $T_A = 25^{\circ}C$, $IOV_{DD} = V_{DD} = V_{CC} = +5V$, $V_{SS} = -5V$, representative unit, unless otherwise noted.

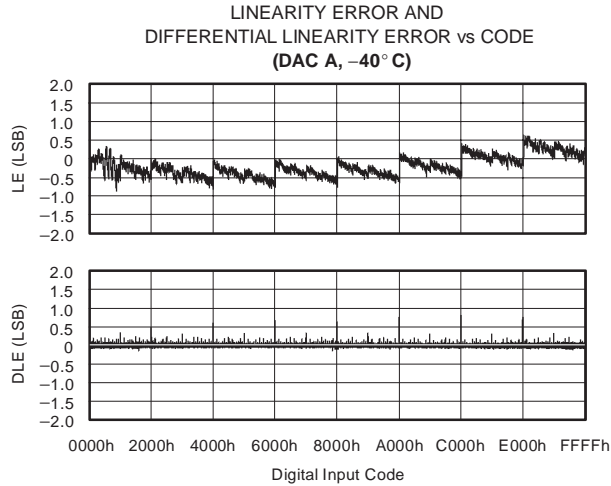

Figure 35

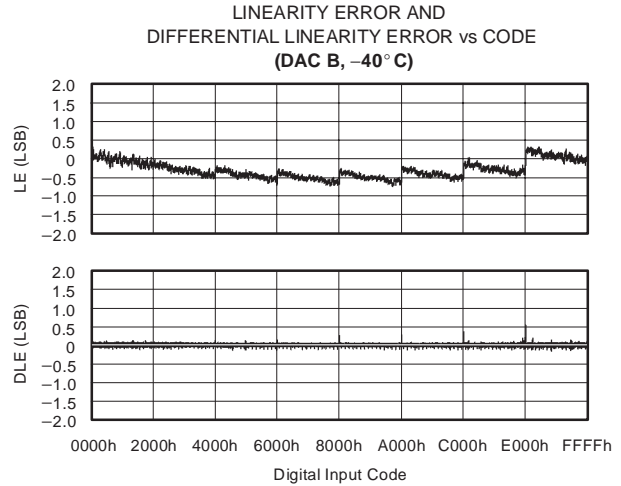

Figure 36

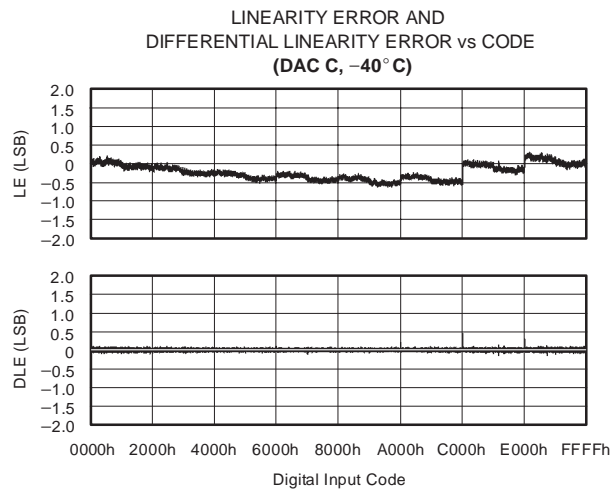

Figure 37

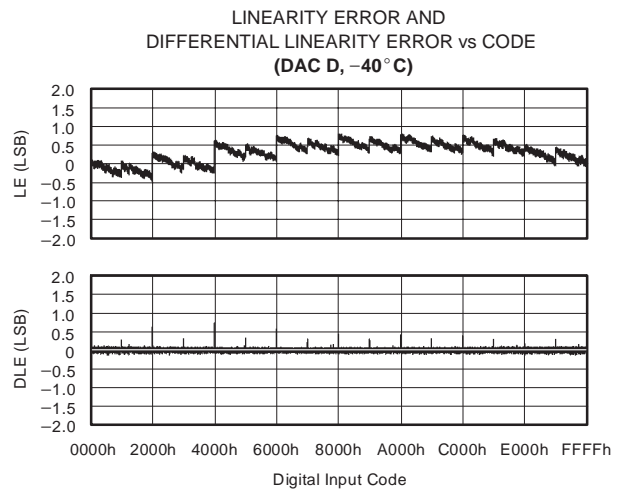

Figure 38

TYPICAL CHARACTERISTICS: $V_{SS} = -5V$

All specifications at $T_A = 25^\circ C$, $IOV_{DD} = V_{DD} = V_{CC} = +5V$, $V_{SS} = -5V$, representative unit, unless otherwise noted.

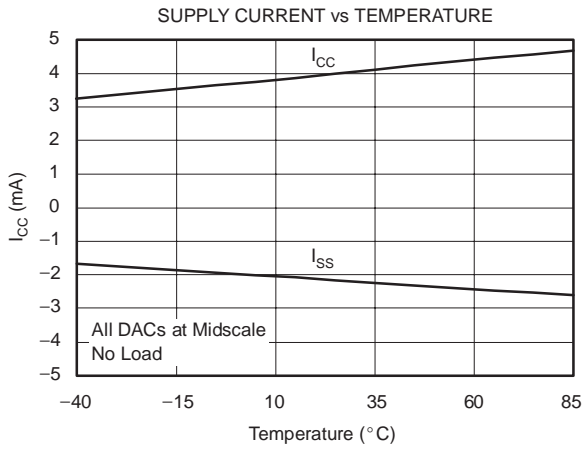

Figure 39

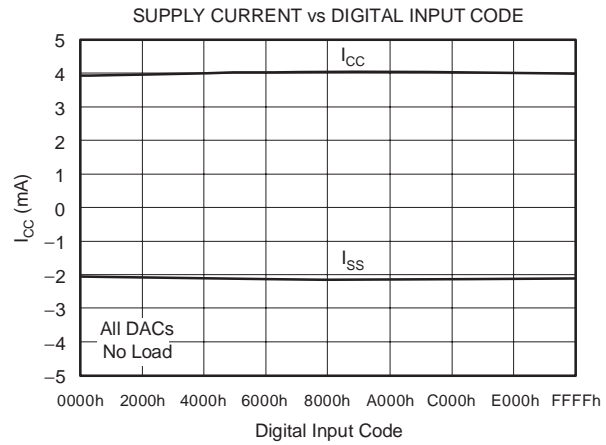

Figure 40

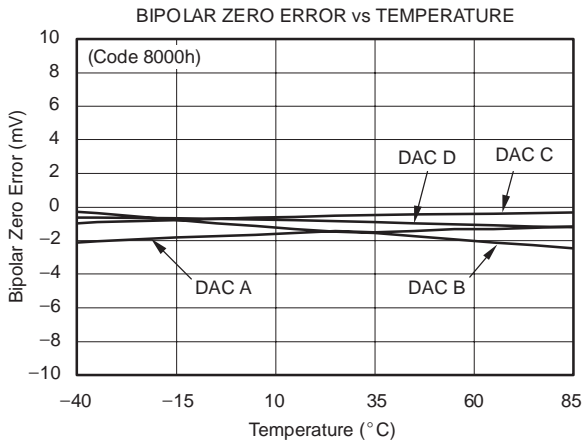

Figure 41

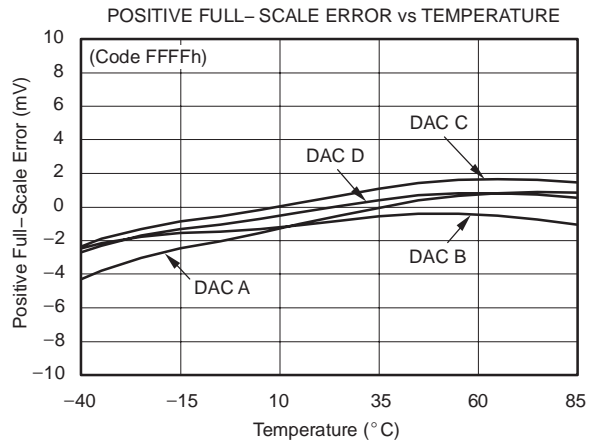

Figure 42

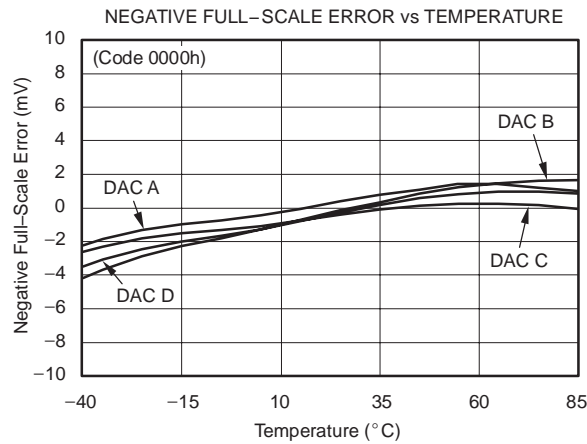

Figure 43

TYPICAL CHARACTERISTICS: $V_{SS} = -5V$ (continued)

All specifications at $T_A = 25^\circ C$, $IOV_{DD} = V_{DD} = V_{CC} = +5V$, $V_{SS} = -5V$, representative unit, unless otherwise noted.

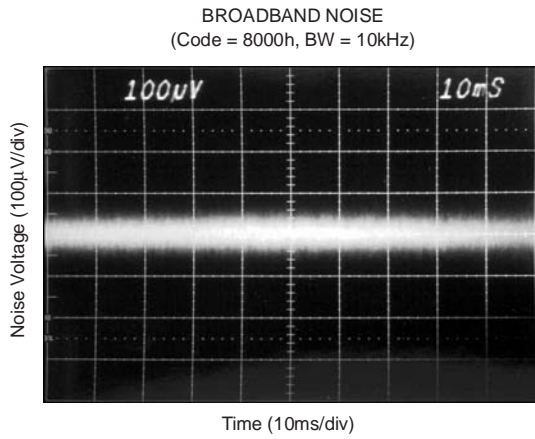

Figure 44

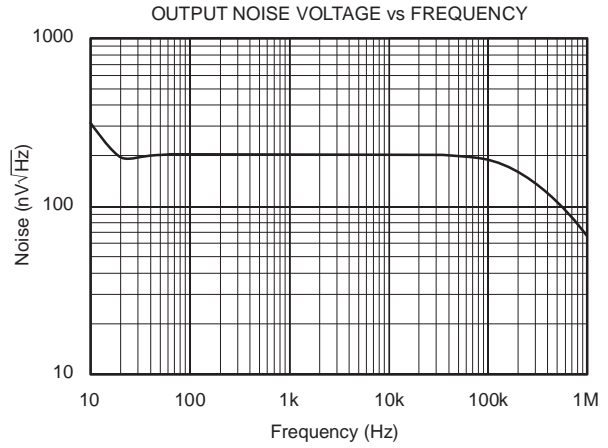

Figure 45

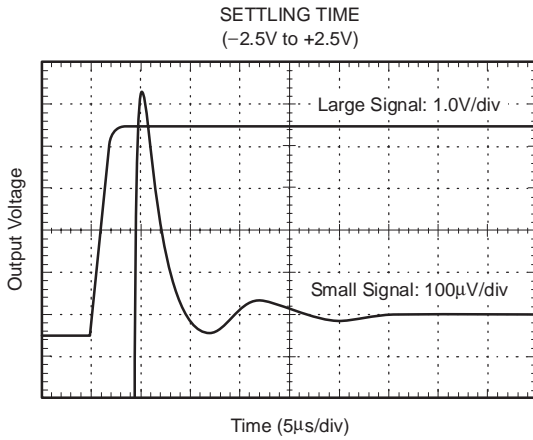

Figure 46

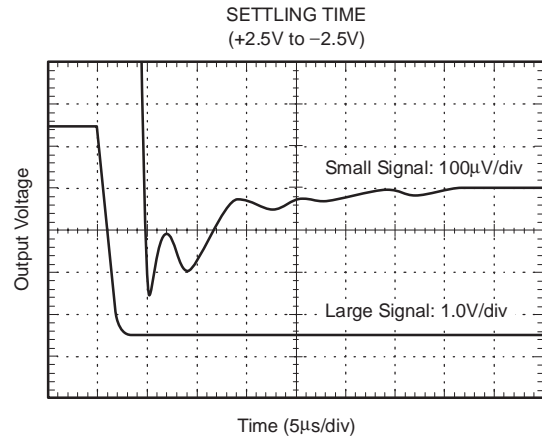

Figure 47

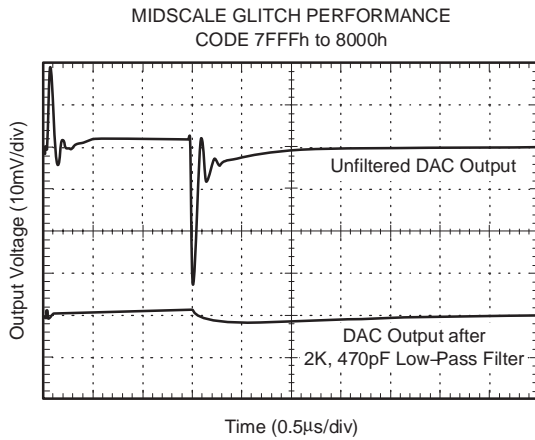

Figure 48

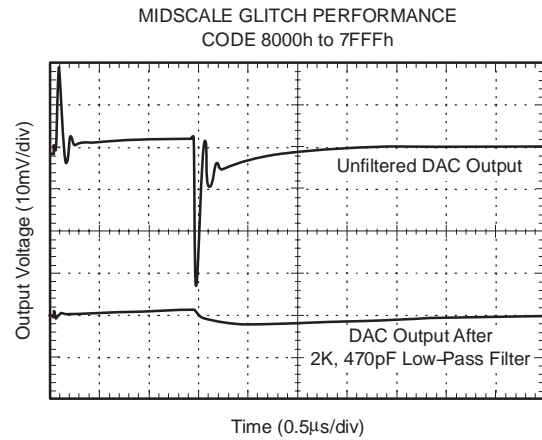

Figure 49

TYPICAL CHARACTERISTICS: $V_{SS} = -5V$ (continued)

All specifications at $T_A = 25^\circ C$, $IOV_{DD} = V_{DD} = V_{CC} = +5V$, $V_{SS} = -5V$, representative unit, unless otherwise noted.

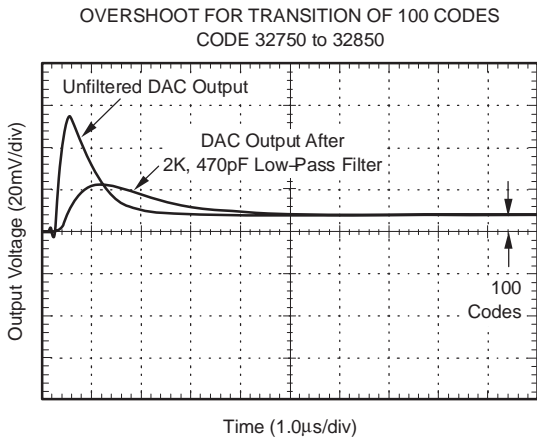

Figure 50

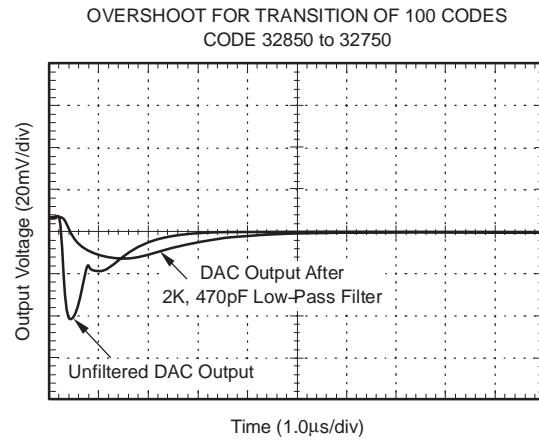

Figure 51

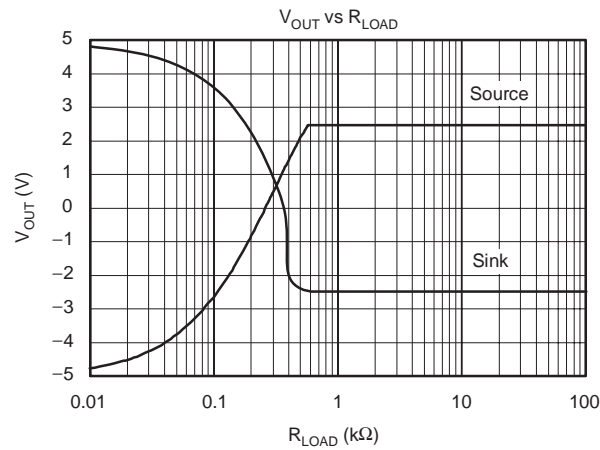

Figure 52

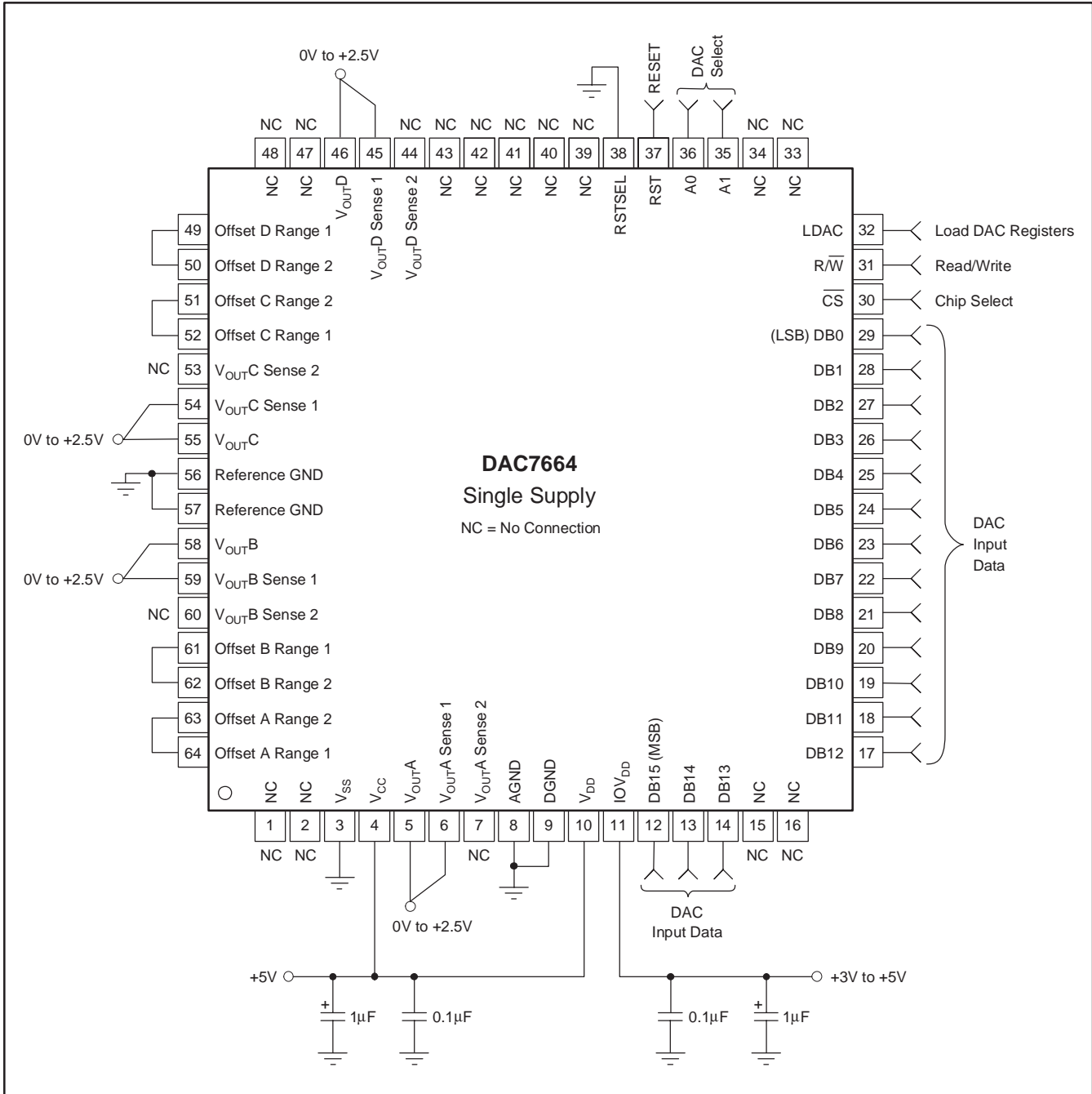

Figure 54. Basic Single-Supply Operation of the DAC7664

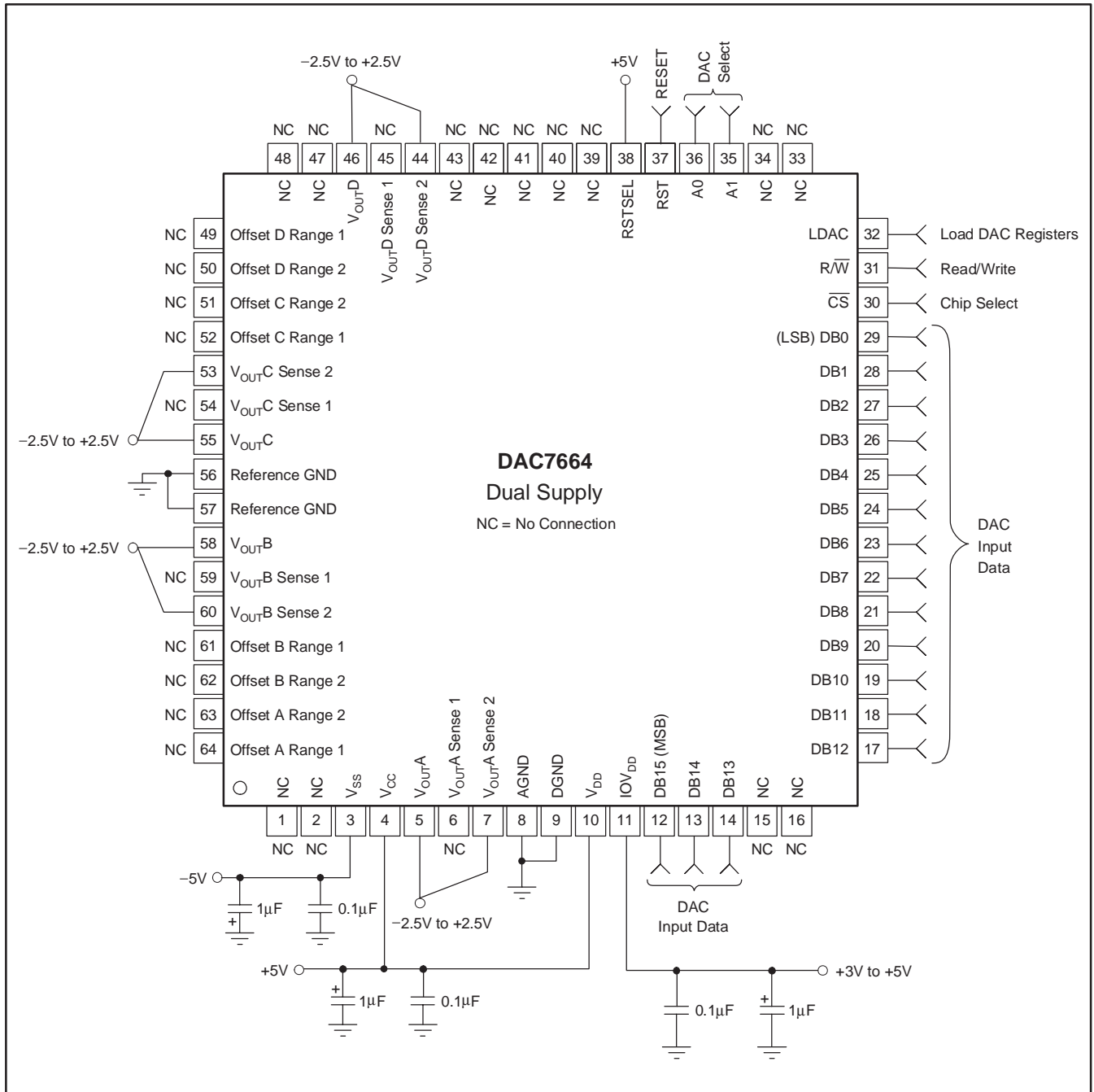

Figure 55. Basic Dual-Supply Operation of the DAC7664

ANALOG OUTPUTS

When $V_{SS} = -5V$ (dual-supply operation), the output amplifier can swing to within 2.25V of the supply rails over a range of $-40^{\circ}C$ to $+85^{\circ}C$. When $V_{SS} = 0V$ (single-supply operation), and with R_{LOAD} also connected to ground, the output can swing to within 5mV of ground. Care must be taken when measuring the zero-scale error when $V_{SS} = 0V$. Since the output voltage cannot swing below ground, the output voltage may not change for the first few digital input codes (0000h, 0001h, 0002h, etc.) if the output amplifier has a negative offset.

Due to the high accuracy of these DACs, system design problems such as grounding and contact resistance are very important. A 16-bit converter with a 2.5V full-scale range has a 1LSB value of $38\mu V$. With a load current of 1mA, series wiring and connector resistance of only $40m\Omega$ (R_{W2}) will cause a voltage drop of $40\mu V$, as shown in Figure 56. To understand what this means in terms of system layout, the resistivity of a typical 1-ounce copper-clad printed circuit board is $1/2 m\Omega$ per square. For a 1mA load, a 0.01-inch-wide printed circuit conductor 0.6 inches long will result in a voltage drop of $30\mu V$.

The DAC7664 offers a force and sense output configuration for the high open-loop gain output amplifier. This feature allows the loop around the output amplifier to be closed at the load (as shown in Figure 56), thus ensuring an accurate output voltage.

DIGITAL INTERFACE

Table 1 shows the basic control logic for the DAC7664. Note that each internal register is edge-triggered and not level-triggered. When the LDAC signal is transitioned to high, the digital word currently in the register is latched. The first set of registers (the input registers) are triggered via the A0, A1, R/\overline{W} , and \overline{CS} inputs. Only one of these registers is transparent at any given time.

The double-buffered architecture is designed mainly so each DAC input register can be written to at any time and then all DAC voltages updated simultaneously by the rising edge of LDAC. It also allows a DAC input register to be written to at any point and the DAC voltages to be synchronously changed via a trigger signal connected to LDAC.

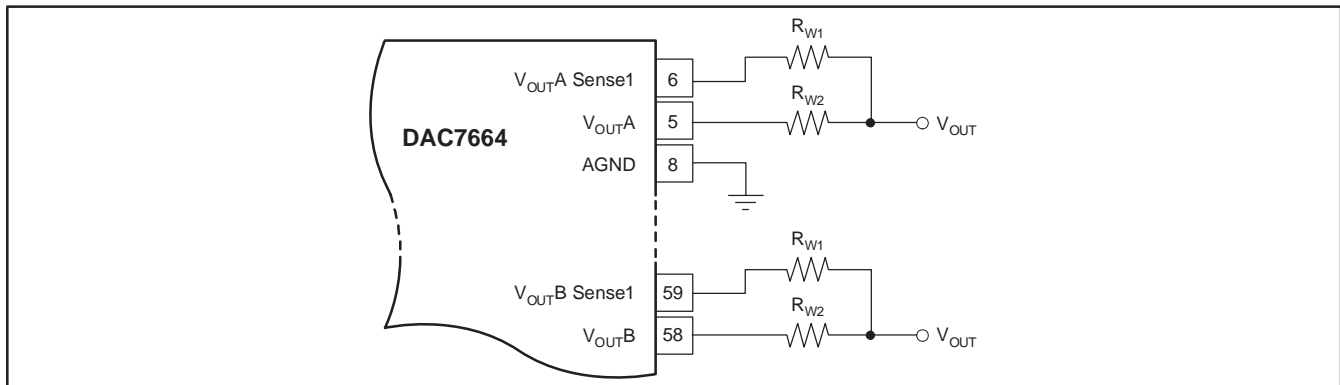

Figure 56. Analog Output Closed-Loop Configuration (1/2 DAC7664). R_W represents wiring resistances.

Table 1. DAC7664 Logic Truth Table

A1	A0	R/W	CS	RST	RSTSEL	LDAC	INPUT REGISTER	DAC REGISTER	MODE	DAC
L	L	L	L	H	X	X	Write	Hold	Write input	A
L	H	L	L	H	X	X	Write	Hold	Write input	B
H	L	L	L	H	X	X	Write	Hold	Write input	C
H	H	L	L	H	X	X	Write	Hold	Write input	D
L	L	H	L	H	X	X	Read	Hold	Read input	A
L	H	H	L	H	X	X	Read	Hold	Read input	B
H	L	H	L	H	X	X	Read	Hold	Read input	C
H	H	H	L	H	X	X	Read	Hold	Read input	D
X	X	X	H	H	X	↑	Hold	Write	Update	All
X	X	X	H	H	X	H	Hold	Hold	Hold	All
X	X	X	X	↑	L	X	Reset to zero	Reset to zero	Reset to zero	All
X	X	X	X	↑	H	X	Reset to mid-scale	Reset to mid-scale	Reset to mid-scale	All

3V TO 5V LOGIC INTERFACE

All of the digital input and output pins are compatible with any logic supply voltage between 3V and 5V. Connect the interface logic supply voltage to the IOV_{DD} pin. Note that the internal digital logic operates from 5V, so the VDD pin must connect to a 5V supply.

GLITCH SUPPRESSION CIRCUIT

Figure 21, Figure 22, Figure 48, and Figure 49 show the typical DAC output when switching between codes 7FFFh and 8000h. For R-2R ladder DACs, this is potentially the worst-case glitch condition, since every switch in the DAC changes state. To minimize the glitch energy at this and other code pairs with possible high-glitch outputs, an internal track-and-hold circuit is used to maintain the DAC output voltage at a nearly constant level during the internal switching interval. This track-and-hold circuit is activated only when the transition is at, or close to, one of the code pairs with the high-glitch possibility.

It is advisable to avoid digital transitions within 1μs of the rising edge of the LDAC signal. These signals can affect the charge on the track-and-hold capacitor, thus increasing the glitch energy.

DIGITAL TIMING

Figure 57 and Table 2 provide detailed timing information for the digital interface of the DAC7664.

DIGITAL INPUT CODING

The DAC7664 input data is in straight binary format. The output voltage for single-supply operation is given by Equation 1:

$$V_{\text{OUT}} = \frac{2.5 \times N}{65,536} \quad (1)$$

where N is the digital input code.

This equation does not include the effects of offset (zero-scale) or gain (full-scale) errors.

The output for the dual supply operation is given by Equation 2:

$$V_{\text{OUT}} = \frac{5 \times N}{65,536} - 2.5 \quad (2)$$

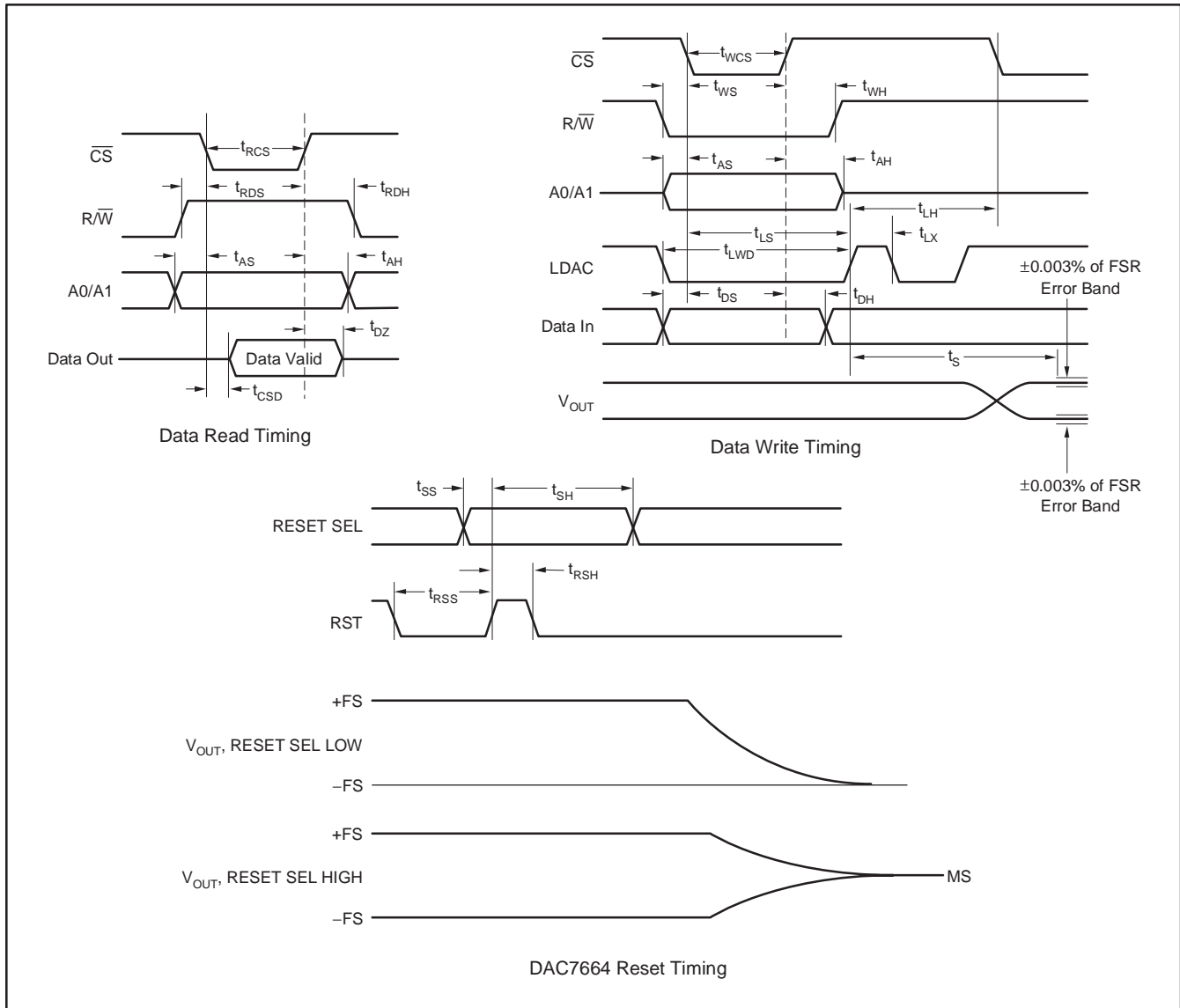

Figure 57. Digital Input and Output Timing

Table 2. Timing Specifications for Figure 57

SYMBOL	DESCRIPTION	MIN	TYP	MAX	UNITS
t _{RCS}	\overline{CS} low for read	150			ns
t _{RDS}	R/ \overline{W} high to \overline{CS} low	10			ns
t _{RDH}	R/ \overline{W} high after \overline{CS} high	10			ns
t _{DZ}	\overline{CS} high to data bus in high impedance	10		100	ns
t _{CSD}	\overline{CS} low to data bus valid		100	150	ns
t _{WCS}	\overline{CS} low for write	40			ns
t _{WS}	R/ \overline{W} low to \overline{CS} low	0			ns
t _{WH}	R/ \overline{W} low after \overline{CS} high	10			ns
t _{AS}	Address valid to \overline{CS} low	0			ns
t _{AH}	Address valid after \overline{CS} high	10			ns
t _{LS}	\overline{CS} low to LDAC high	30			ns
t _{LH}	\overline{CS} low after LDAC high	100			ns
t _{LX}	LDAC high	100			ns
t _{DS}	Data valid to \overline{CS} low	0			ns
t _{DH}	Data valid after \overline{CS} low	10			ns
t _{LWD}	LDAC low	100			ns
t _{SS}	RSTSEL valid before RST high	0			ns
t _{SH}	RSTSEL valid after RST high	200			ns
t _{RSS}	RSTSEL low before RST high	10			ns
t _{RSH}	RSTSEL low after RST high	10			ns
t _S	Settling time		12		μs

PACKAGING INFORMATION

Orderable Device	Status (1)	Package Type	Package Drawing	Pins	Package Qty	Eco Plan (2)	Lead/Ball Finish (6)	MSL Peak Temp (3)	Op Temp (°C)	Device Marking (4/5)	Samples
DAC7664YBT	ACTIVE	LQFP	PM	64	250	Green (RoHS & no Sb/Br)	CU NIPDAU-DCC	Level-3-260C-168 HR	-40 to 85	DAC7664Y B	Samples
DAC7664YCT	ACTIVE	LQFP	PM	64	250	Green (RoHS & no Sb/Br)	CU NIPDAU-DCC	Level-3-260C-168 HR	-40 to 85	DAC7664Y C	Samples
DAC7664YCTG4	ACTIVE	LQFP	PM	64	250	Green (RoHS & no Sb/Br)	CU NIPDAU-DCC	Level-3-260C-168 HR	-40 to 85	DAC7664Y C	Samples
DAC7664YT	ACTIVE	LQFP	PM	64	250	Green (RoHS & no Sb/Br)	CU NIPDAU-DCC	Level-3-260C-168 HR	-40 to 85	DAC7664Y	Samples

(1) The marketing status values are defined as follows:

ACTIVE: Product device recommended for new designs.

LIFEBUY: TI has announced that the device will be discontinued, and a lifetime-buy period is in effect.

NRND: Not recommended for new designs. Device is in production to support existing customers, but TI does not recommend using this part in a new design.

PREVIEW: Device has been announced but is not in production. Samples may or may not be available.

OBSOLETE: TI has discontinued the production of the device.

(2) Eco Plan - The planned eco-friendly classification: Pb-Free (RoHS), Pb-Free (RoHS Exempt), or Green (RoHS & no Sb/Br) - please check <http://www.ti.com/productcontent> for the latest availability information and additional product content details.

TBD: The Pb-Free/Green conversion plan has not been defined.

Pb-Free (RoHS): TI's terms "Lead-Free" or "Pb-Free" mean semiconductor products that are compatible with the current RoHS requirements for all 6 substances, including the requirement that lead not exceed 0.1% by weight in homogeneous materials. Where designed to be soldered at high temperatures, TI Pb-Free products are suitable for use in specified lead-free processes.

Pb-Free (RoHS Exempt): This component has a RoHS exemption for either 1) lead-based flip-chip solder bumps used between the die and package, or 2) lead-based die adhesive used between the die and leadframe. The component is otherwise considered Pb-Free (RoHS compatible) as defined above.

Green (RoHS & no Sb/Br): TI defines "Green" to mean Pb-Free (RoHS compatible), and free of Bromine (Br) and Antimony (Sb) based flame retardants (Br or Sb do not exceed 0.1% by weight in homogeneous material)

(3) MSL, Peak Temp. - The Moisture Sensitivity Level rating according to the JEDEC industry standard classifications, and peak solder temperature.

(4) There may be additional marking, which relates to the logo, the lot trace code information, or the environmental category on the device.

(5) Multiple Device Markings will be inside parentheses. Only one Device Marking contained in parentheses and separated by a "~" will appear on a device. If a line is indented then it is a continuation of the previous line and the two combined represent the entire Device Marking for that device.

(6) Lead/Ball Finish - Orderable Devices may have multiple material finish options. Finish options are separated by a vertical ruled line. Lead/Ball Finish values may wrap to two lines if the finish value exceeds the maximum column width.

Important Information and Disclaimer: The information provided on this page represents TI's knowledge and belief as of the date that it is provided. TI bases its knowledge and belief on information provided by third parties, and makes no representation or warranty as to the accuracy of such information. Efforts are underway to better integrate information from third parties. TI has taken and continues to take reasonable steps to provide representative and accurate information but may not have conducted destructive testing or chemical analysis on incoming materials and chemicals. TI and TI suppliers consider certain information to be proprietary, and thus CAS numbers and other limited information may not be available for release.

In no event shall TI's liability arising out of such information exceed the total purchase price of the TI part(s) at issue in this document sold by TI to Customer on an annual basis.

TAPE AND REEL INFORMATION



QUADRANT ASSIGNMENTS FOR PIN 1 ORIENTATION IN TAPE



*All dimensions are nominal

Device	Package Type	Package Drawing	Pins	SPQ	Reel Diameter (mm)	Reel Width W1 (mm)	A0 (mm)	B0 (mm)	K0 (mm)	P1 (mm)	W (mm)	Pin1 Quadrant
DAC7664YBT	LQFP	PM	64	250	180.0	24.4	13.0	13.0	2.1	16.0	24.0	Q2
DAC7664YCT	LQFP	PM	64	250	180.0	24.4	13.0	13.0	2.1	16.0	24.0	Q2
DAC7664YT	LQFP	PM	64	250	180.0	24.4	13.0	13.0	2.1	16.0	24.0	Q2

TAPE AND REEL BOX DIMENSIONS



*All dimensions are nominal

Device	Package Type	Package Drawing	Pins	SPQ	Length (mm)	Width (mm)	Height (mm)
DAC7664YBT	LQFP	PM	64	250	213.0	191.0	55.0
DAC7664YCT	LQFP	PM	64	250	213.0	191.0	55.0
DAC7664YT	LQFP	PM	64	250	213.0	191.0	55.0

PM (S-PQFP-G64)

PLASTIC QUAD FLATPACK

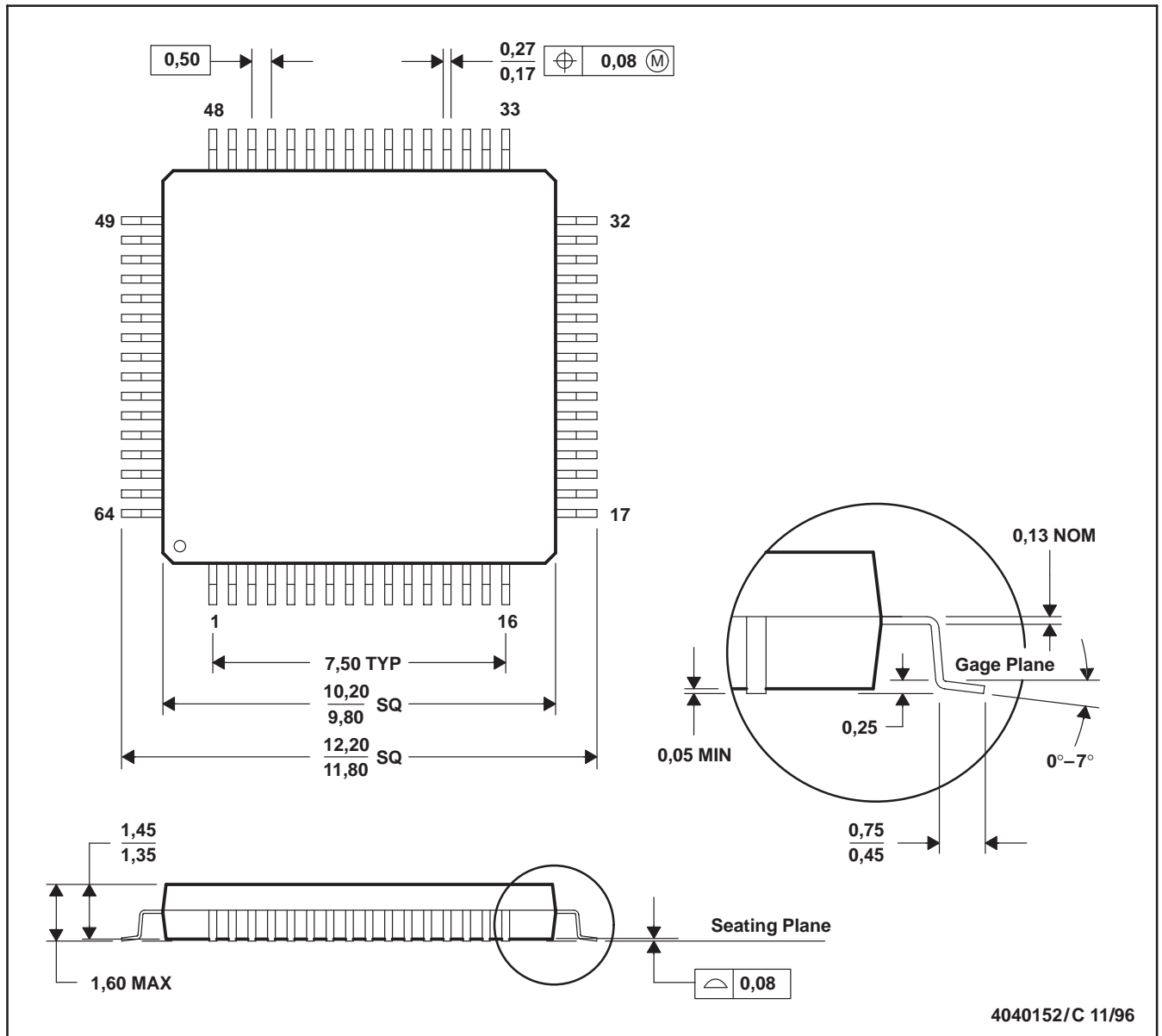

- NOTES: A. All linear dimensions are in millimeters.
 B. This drawing is subject to change without notice.
 C. Falls within JEDEC MS-026
 D. May also be thermally enhanced plastic with leads connected to the die pads.

PM (S-PQFP-G64)

PLASTIC QUAD FLATPACK

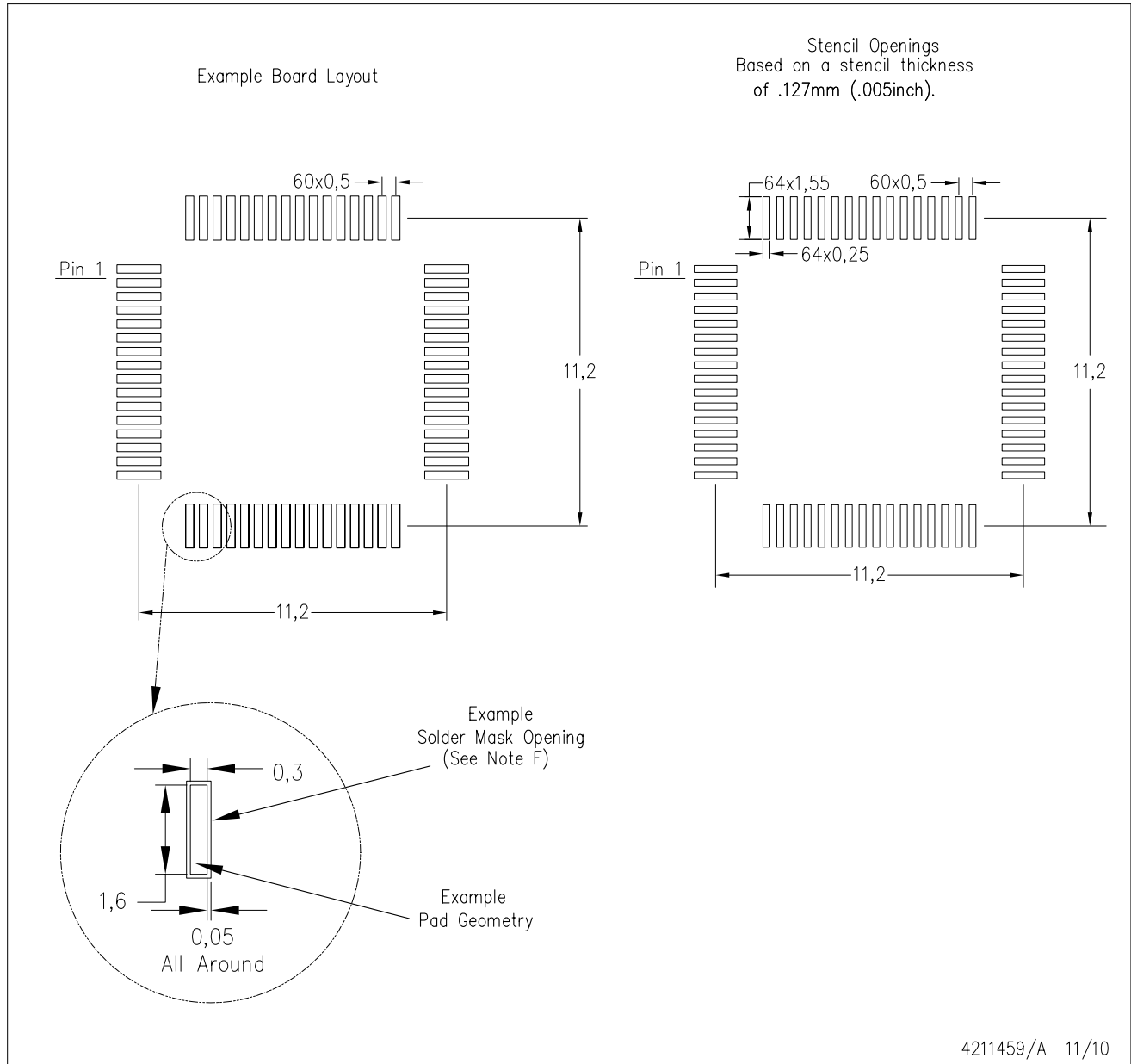

- NOTES:
- A. All linear dimensions are in millimeters.
 - B. This drawing is subject to change without notice.
 - C. Laser cutting apertures with trapezoidal walls and also rounding corners will offer better paste release. Customers should contact their board assembly site for stencil design recommendations. Example stencil design based on a 50% volumetric metal load solder paste. Refer to IPC-7525 for other stencil recommendations.
 - D. Customers should contact their board fabrication site for solder mask tolerances between and around signal pads.

IMPORTANT NOTICE

Texas Instruments Incorporated and its subsidiaries (TI) reserve the right to make corrections, enhancements, improvements and other changes to its semiconductor products and services per JESD46, latest issue, and to discontinue any product or service per JESD48, latest issue. Buyers should obtain the latest relevant information before placing orders and should verify that such information is current and complete. All semiconductor products (also referred to herein as "components") are sold subject to TI's terms and conditions of sale supplied at the time of order acknowledgment.

TI warrants performance of its components to the specifications applicable at the time of sale, in accordance with the warranty in TI's terms and conditions of sale of semiconductor products. Testing and other quality control techniques are used to the extent TI deems necessary to support this warranty. Except where mandated by applicable law, testing of all parameters of each component is not necessarily performed.

TI assumes no liability for applications assistance or the design of Buyers' products. Buyers are responsible for their products and applications using TI components. To minimize the risks associated with Buyers' products and applications, Buyers should provide adequate design and operating safeguards.

TI does not warrant or represent that any license, either express or implied, is granted under any patent right, copyright, mask work right, or other intellectual property right relating to any combination, machine, or process in which TI components or services are used. Information published by TI regarding third-party products or services does not constitute a license to use such products or services or a warranty or endorsement thereof. Use of such information may require a license from a third party under the patents or other intellectual property of the third party, or a license from TI under the patents or other intellectual property of TI.

Reproduction of significant portions of TI information in TI data books or data sheets is permissible only if reproduction is without alteration and is accompanied by all associated warranties, conditions, limitations, and notices. TI is not responsible or liable for such altered documentation. Information of third parties may be subject to additional restrictions.

Resale of TI components or services with statements different from or beyond the parameters stated by TI for that component or service voids all express and any implied warranties for the associated TI component or service and is an unfair and deceptive business practice. TI is not responsible or liable for any such statements.

Buyer acknowledges and agrees that it is solely responsible for compliance with all legal, regulatory and safety-related requirements concerning its products, and any use of TI components in its applications, notwithstanding any applications-related information or support that may be provided by TI. Buyer represents and agrees that it has all the necessary expertise to create and implement safeguards which anticipate dangerous consequences of failures, monitor failures and their consequences, lessen the likelihood of failures that might cause harm and take appropriate remedial actions. Buyer will fully indemnify TI and its representatives against any damages arising out of the use of any TI components in safety-critical applications.

In some cases, TI components may be promoted specifically to facilitate safety-related applications. With such components, TI's goal is to help enable customers to design and create their own end-product solutions that meet applicable functional safety standards and requirements. Nonetheless, such components are subject to these terms.

No TI components are authorized for use in FDA Class III (or similar life-critical medical equipment) unless authorized officers of the parties have executed a special agreement specifically governing such use.

Only those TI components which TI has specifically designated as military grade or "enhanced plastic" are designed and intended for use in military/aerospace applications or environments. Buyer acknowledges and agrees that any military or aerospace use of TI components which have **not** been so designated is solely at the Buyer's risk, and that Buyer is solely responsible for compliance with all legal and regulatory requirements in connection with such use.

TI has specifically designated certain components as meeting ISO/TS16949 requirements, mainly for automotive use. In any case of use of non-designated products, TI will not be responsible for any failure to meet ISO/TS16949.

Products

Audio	www.ti.com/audio
Amplifiers	amplifier.ti.com
Data Converters	dataconverter.ti.com
DLP® Products	www.dlp.com
DSP	dsp.ti.com
Clocks and Timers	www.ti.com/clocks
Interface	interface.ti.com
Logic	logic.ti.com
Power Mgmt	power.ti.com
Microcontrollers	microcontroller.ti.com
RFID	www.ti-rfid.com
OMAP Applications Processors	www.ti.com/omap
Wireless Connectivity	www.ti.com/wirelessconnectivity

Applications

Automotive and Transportation	www.ti.com/automotive
Communications and Telecom	www.ti.com/communications
Computers and Peripherals	www.ti.com/computers
Consumer Electronics	www.ti.com/consumer-apps
Energy and Lighting	www.ti.com/energy
Industrial	www.ti.com/industrial
Medical	www.ti.com/medical
Security	www.ti.com/security
Space, Avionics and Defense	www.ti.com/space-avionics-defense
Video and Imaging	www.ti.com/video

TI E2E Community

e2e.ti.com

Looking for pricing, stock, or lifecycle information?

Click below to explore more details on WIN SOURCE:

 [View DAC7664YBT on WIN SOURCE](#)

 [Texas Instruments](#) Information

Optimize Your Supply Chain with WIN SOURCE Solutions

-  Global Sourcing Solution
-  Obsolete Management
-  Cost Control Management
-  Shortage Management
-  Alternative Solution
-  Excess Inventory Management