



**THE DATASHEET OF
NID5003NT4**



NID5003N

Preferred Device

Self-Protected FET with Temperature and Current Limit

42 V, 20 A, Single N-Channel, DPAK

HDPlus™ devices are an advanced series of power MOSFETs which utilize ON Semiconductors latest MOSFET technology process to achieve the lowest possible on-resistance per silicon area while incorporating smart features. Integrated thermal and current limits work together to provide short circuit protection. The devices feature an integrated Drain-to-Gate Clamp that enables them to withstand high energy in the avalanche mode. The Clamp also provides additional safety margin against unexpected voltage transients. Electrostatic Discharge (ESD) protection is provided by an integrated Gate-to-Source Clamp.

Features

- Short Circuit Protection/Current Limit
- Thermal Shutdown with Automatic Restart
- I_{DSS} Specified at Elevated Temperature
- Avalanche Energy Specified
- Slew Rate Control for Low Noise Switching
- Overvoltage Clamped Protection

MOSFET MAXIMUM RATINGS ($T_J = 25^\circ\text{C}$ unless otherwise noted)

Rating	Symbol	Value	Unit
Drain-to-Source Voltage Internally Clamped	V_{DSS}	42	Vdc
Gate-to-Source Voltage	V_{GS}	± 14	Vdc
Drain Current Continuous	I_D	Internally Limited	
Total Power Dissipation @ $T_A = 25^\circ\text{C}$ (Note 1) @ $T_A = 25^\circ\text{C}$ (Note 2)	P_D	1.3 2.3	W
Thermal Resistance Junction-to-Case Junction-to-Ambient (Note 1) Junction-to-Ambient (Note 2)	$R_{\theta JC}$ $R_{\theta JA}$ $R_{\theta JA}$	3.0 95 54	$^\circ\text{C}/\text{W}$
Single Pulse Drain-to-Source Avalanche Energy ($V_{DD} = 25\text{ Vdc}$, $V_{GS} = 5.0\text{ Vdc}$, $I_L = 3.2\text{ Apk}$, $L = 120\text{ mH}$, $R_G = 25\ \Omega$)	E_{AS}	600	mJ
Operating and Storage Temperature Range (Note 3)	T_J , T_{stg}	-55 to 150	$^\circ\text{C}$

Maximum ratings are those values beyond which device damage can occur. Maximum ratings applied to the device are individual stress limit values (not normal operating conditions) and are not valid simultaneously. If these limits are exceeded, device functional operation is not implied, damage may occur and reliability may be affected.

1. Surface mounted onto minimum pad size (0.412" square) FR4 PCB, 1 oz cu.
2. Mounted onto 1" square pad size (1.127" square) FR4 PCB, 1 oz cu.
3. Normal pre-fault operating range. See thermal limit range conditions.



ON Semiconductor®

<http://onsemi.com>

V_{DSS} (Clamped)	$R_{DS(on)}$ TYP	I_D MAX (Limited)
42 V	42 m Ω @ 10 V	20 A*

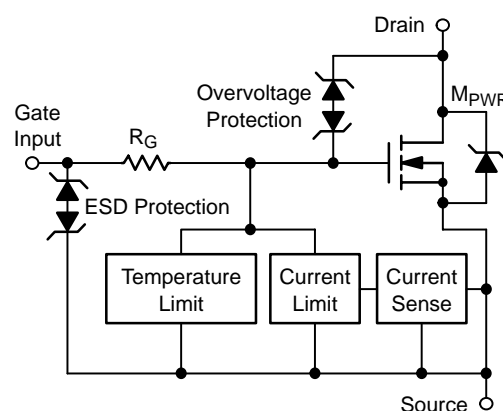

DPAK
CASE 369C
STYLE 2

MARKING DIAGRAM

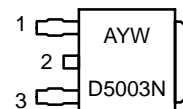

D5003N = Device Code
A = Assembly Location
Y = Year
W = Work Week

1 = Gate
2 = Drain
3 = Source

ORDERING INFORMATION

Device	Package	Shipping†
NID5003NT4	DPAK	2500/Tape & Reel

†For information on tape and reel specifications, including part orientation and tape sizes, please refer to our Tape and Reel Packaging Specification Brochure, BRD8011/D.

Preferred devices are recommended choices for future use and best overall value.

*Max current may be limited below this value depending on input conditions.

NID5003N

MOSFET ELECTRICAL CHARACTERISTICS (T_J = 25°C unless otherwise noted)

Characteristic	Symbol	Min	Typ	Max	Unit
----------------	--------	-----	-----	-----	------

OFF CHARACTERISTICS

Drain-to-Source Clamped Breakdown Voltage (V _{GS} = 0 Vdc, I _D = 250 μAdc) (V _{GS} = 0 Vdc, I _D = 250 μAdc, T _J = -40°C to 150°C)	V _{(BR)DSS}	42 40	46 45	51 51	Vdc
Zero Gate Voltage Drain Current (V _{DS} = 32 Vdc, V _{GS} = 0 Vdc) (V _{DS} = 32 Vdc, V _{GS} = 0 Vdc, T _J = 150°C)	I _{DSS}	- -	0.6 2.5	5.0 -	μAdc
Gate Input Current (V _{GS} = 5.0 Vdc, V _{DS} = 0 Vdc)	I _{GSSF}	-	50	125	μAdc

ON CHARACTERISTICS

Gate Threshold Voltage (V _{DS} = V _{GS} , I _D = 1.2 mAdc) Threshold Temperature Coefficient	V _{GS(th)}	1.0 -	1.7 5.0	2.2 -	Vdc -mV/°C
Static Drain-to-Source On-Resistance (Note 4) (V _{GS} = 10 Vdc, I _D = 3.0 Adc, T _J @ 25°C) (V _{GS} = 10 Vdc, I _D = 3.0 Adc, T _J @ 150°C)	R _{DS(on)}	- -	42 76	51 104	mΩ
Static Drain-to-Source On-Resistance (Note 4) (V _{GS} = 5.0 Vdc, I _D = 3.0 Adc, T _J @ 25°C) (V _{GS} = 5.0 Vdc, I _D = 3.0 Adc, T _J @ 150°C)	R _{DS(on)}	- -	50 88	58 125	mΩ
Source-Drain Forward On Voltage (I _S = 7.0 A, V _{GS} = 0 V)	V _{SD}	-	0.95	1.1	V

SWITCHING CHARACTERISTICS

Turn-on Time (V _{in} to 90% I _D)	R _L = 4.7 Ω, V _{in} = 0 to 10 V, V _{DD} = 12 V	T _(on)	-	16	20	μs
Turn-off Time (V _{in} to 10% I _D)	R _L = 4.7 Ω, V _{in} = 0 to 10 V, V _{DD} = 12 V	T _(off)	-	80	100	
Slew Rate On	R _L = 4.7 Ω, V _{in} = 0 to 10 V, V _{DD} = 12 V	-dV _{DS} /dt _{on}	-	1.4	-	V/μs
Slew Rate Off	R _L = 4.7 Ω, V _{in} = 10 to 0 V, V _{DD} = 12 V	dV _{DS} /dt _{off}	-	0.5	-	V/μs

SELF PROTECTION CHARACTERISTICS (T_J = 25°C unless otherwise noted) (Note 5)

Current Limit	(V _{GS} = 5.0 Vdc) V _{DS} = 10 V (V _{GS} = 5.0 Vdc, T _J = 150°C)	I _{LIM}	12 7	18 13	24 18	Adc
Current Limit	(V _{GS} = 10 Vdc) V _{DS} = 10 V (V _{GS} = 10 Vdc, T _J = 150°C)	I _{LIM}	18 13	22 18	30 25	
Temperature Limit (Turn-off)	V _{GS} = 5.0 Vdc	T _{LIM(off)}	150	175	200	°C
Thermal Hysteresis	V _{GS} = 5.0 Vdc	ΔT _{LIM(on)}	-	15	-	°C
Temperature Limit (Turn-off)	V _{GS} = 10 Vdc	T _{LIM(off)}	150	165	185	°C
Thermal Hysteresis	V _{GS} = 10 Vdc	ΔT _{LIM(on)}	-	15	-	°C
Input Current during Thermal Fault	V _{DS} = 35 V, (V _{GS} = 5.0 V, T _J = 150°C)	I _{g(fault)}	0.6	-	-	mA
Input Current during Thermal Fault	V _{DS} = 35 V, (V _{GS} = 10 V, T _J = 150°C)	I _{g(fault)}	2.0	-	-	mA

ESD ELECTRICAL CHARACTERISTICS (T_J = 25°C unless otherwise noted)

Electro-Static Discharge Capability Human Body Model (HBM) Machine Model (MM)	ESD	4000 400	- -	- -	V
---	-----	-------------	--------	--------	---

4. Pulse Test: Pulse Width ≤ 300 μs, Duty Cycle ≤ 2%.
5. Fault conditions are viewed as beyond the normal operating range of the part.

TYPICAL PERFORMANCE CURVES

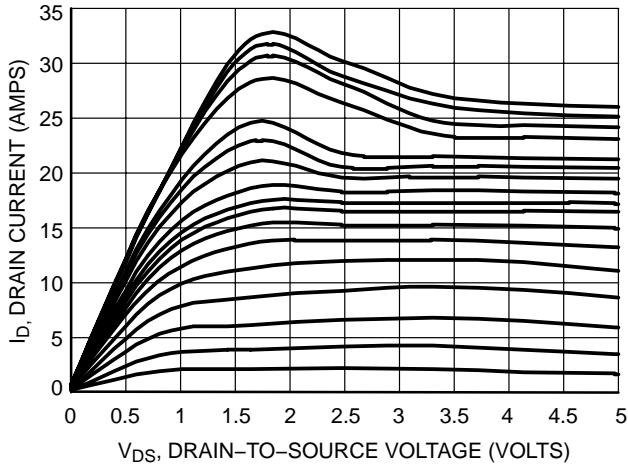

Figure 1. On-Region Characteristics

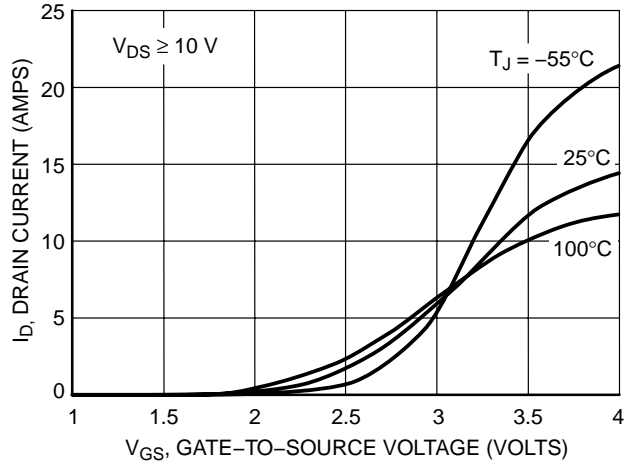

Figure 2. Transfer Characteristics

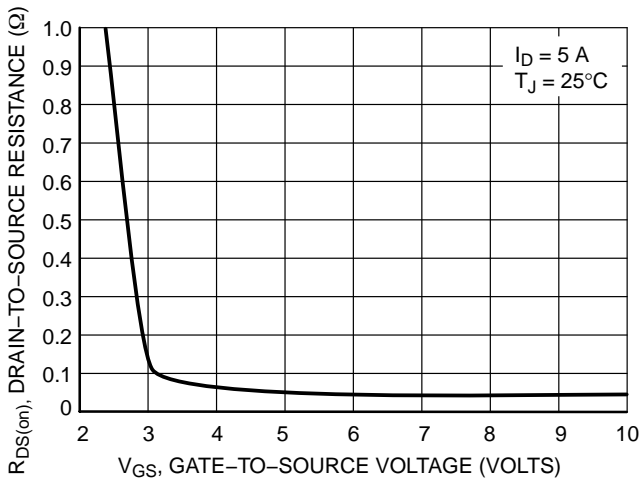

Figure 3. On-Resistance vs. Gate-to-Source Voltage

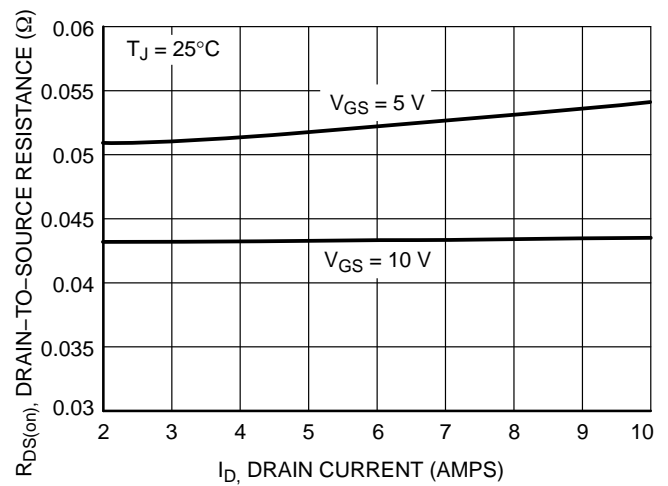

Figure 4. On-Resistance vs. Drain Current and Gate Voltage

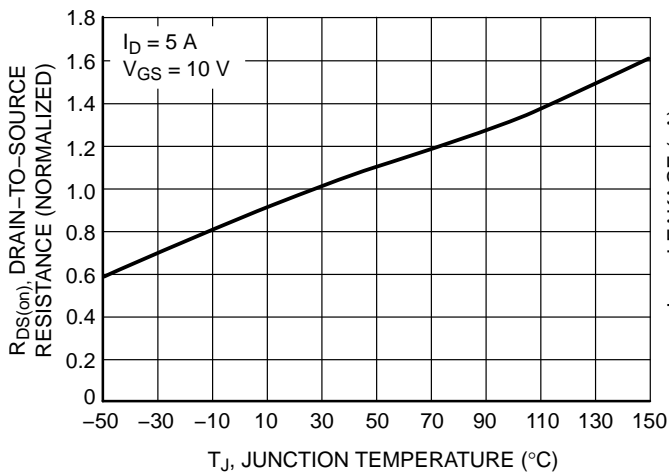

Figure 5. On-Resistance Variation with Temperature

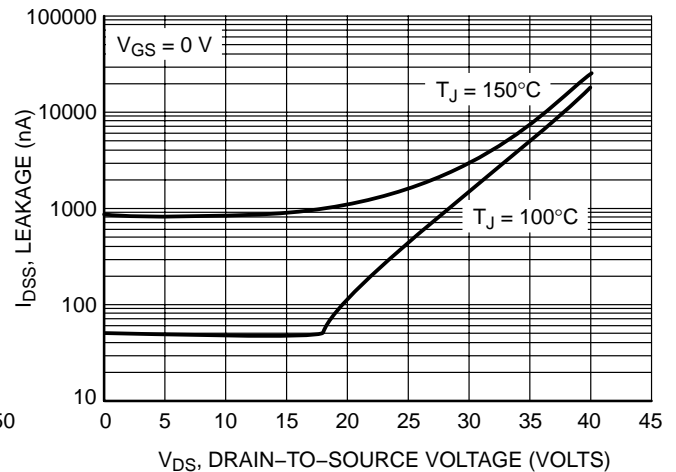

Figure 6. Drain-to-Source Leakage Current vs. Voltage

NID5003N

TYPICAL PERFORMANCE CURVES

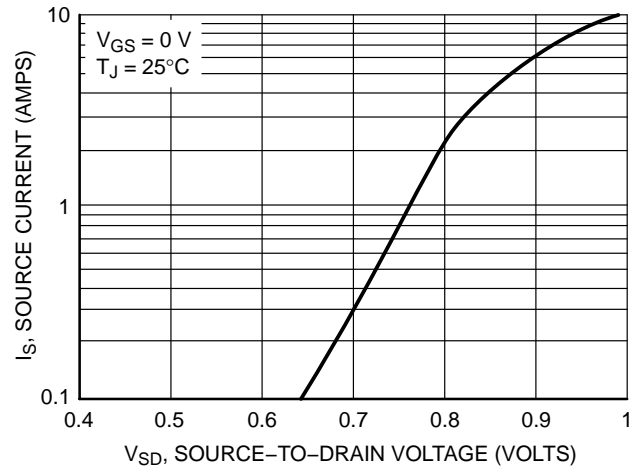
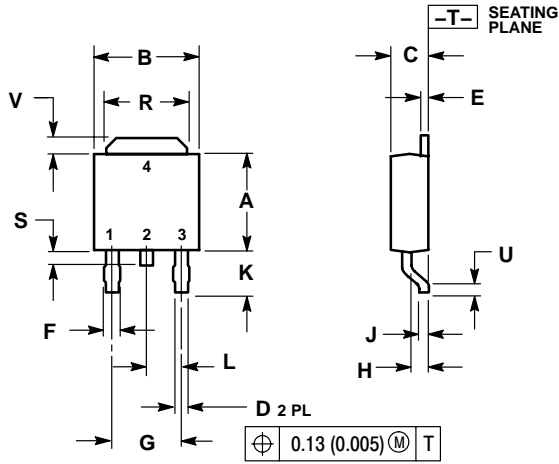

Figure 7. Diode Forward Voltage vs. Current

NID5003N

PACKAGE DIMENSIONS

DPAK
CASE 369C-01
ISSUE O



DIM	INCHES		MILLIMETERS	
	MIN	MAX	MIN	MAX
A	0.235	0.245	5.97	6.22
B	0.250	0.265	6.35	6.73
C	0.086	0.094	2.19	2.38
D	0.027	0.035	0.69	0.88
E	0.018	0.023	0.46	0.58
F	0.037	0.045	0.94	1.14
G	0.180 BSC		4.58 BSC	
H	0.034	0.040	0.87	1.01
J	0.018	0.023	0.46	0.58
K	0.102	0.114	2.60	2.89
L	0.090 BSC		2.29 BSC	
R	0.180	0.215	4.57	5.45
S	0.025	0.040	0.63	1.01
U	0.020	---	0.51	---
V	0.035	0.050	0.89	1.27
Z	0.155	---	3.93	---

STYLE 2:
PIN 1. GATE
2. DRAIN
3. SOURCE
4. DRAIN

SOLDERING FOOTPRINT

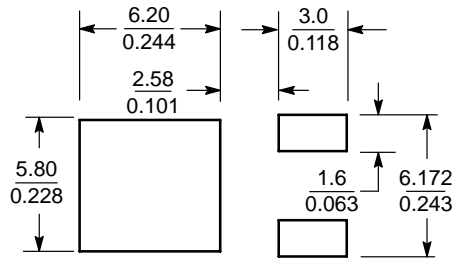

SCALE 3:1 (mm / inches)

NID5003N

HDPlus is a trademark of Semiconductor Components Industries, LLC (SCILLC)

ON Semiconductor and  are registered trademarks of Semiconductor Components Industries, LLC (SCILLC). SCILLC reserves the right to make changes without further notice to any products herein. SCILLC makes no warranty, representation or guarantee regarding the suitability of its products for any particular purpose, nor does SCILLC assume any liability arising out of the application or use of any product or circuit, and specifically disclaims any and all liability, including without limitation special, consequential or incidental damages. "Typical" parameters which may be provided in SCILLC data sheets and/or specifications can and do vary in different applications and actual performance may vary over time. All operating parameters, including "Typicals" must be validated for each customer application by customer's technical experts. SCILLC does not convey any license under its patent rights nor the rights of others. SCILLC products are not designed, intended, or authorized for use as components in systems intended for surgical implant into the body, or other applications intended to support or sustain life, or for any other application in which the failure of the SCILLC product could create a situation where personal injury or death may occur. Should Buyer purchase or use SCILLC products for any such unintended or unauthorized application, Buyer shall indemnify and hold SCILLC and its officers, employees, subsidiaries, affiliates, and distributors harmless against all claims, costs, damages, and expenses, and reasonable attorney fees arising out of, directly or indirectly, any claim of personal injury or death associated with such unintended or unauthorized use, even if such claim alleges that SCILLC was negligent regarding the design or manufacture of the part. SCILLC is an Equal Opportunity/Affirmative Action Employer. This literature is subject to all applicable copyright laws and is not for resale in any manner.

PUBLICATION ORDERING INFORMATION

LITERATURE FULFILLMENT:

Literature Distribution Center for ON Semiconductor
P.O. Box 61312, Phoenix, Arizona 85082-1312 USA
Phone: 480-829-7710 or 800-344-3860 Toll Free USA/Canada
Fax: 480-829-7709 or 800-344-3867 Toll Free USA/Canada
Email: orderlit@onsemi.com

N. American Technical Support: 800-282-9855 Toll Free
USA/Canada

Japan: ON Semiconductor, Japan Customer Focus Center
2-9-1 Kamimeguro, Meguro-ku, Tokyo, Japan 153-0051
Phone: 81-3-5773-3850

ON Semiconductor Website: <http://onsemi.com>

Order Literature: <http://www.onsemi.com/litorder>

For additional information, please contact your
local Sales Representative.

NID5003N/D

Looking for pricing, stock, or lifecycle information?

Click below to explore more details on WIN SOURCE:

- ⊖ [View NID5003NT4](#) on WIN SOURCE
- ⊖ [ON Semiconductor](#) Information

Optimize Your Supply Chain with WIN SOURCE Solutions

- ✓ Global Sourcing Solution
- ✓ Obsolete Management
- ✓ Cost Control Management
- ✓ Shortage Management
- ✓ Alternative Solution
- ✓ Excess Inventory Management