



Fixed Resistors (Surface Mount Resistors) CONTENTS

Classification	Product Item	Part No.	Page
Safety Precautions (Common precautions for Fixed Resistors)			2
Safety Precautions (Common precautions for Surface Mount Resistors)			3
Chip Resistors	Thick Film Chip Resistors	ERJ XG, 1G, 2G, 3G, 6G, 8G, 14, 12, 12Z, 1T	4
	Precision Thick Film Chip Resistors	ERJ XG, 1G, 1R, 2R, 3R, 6R, 3E, 6E, 8E, 14, 12, 1T	7
High Precision	Metal Film (Thin Film) Chip Resistors, High Reliability Type	ERA 1A, 2A, 3A, 6A, 8A	11
	High Precision Thick Film Chip Resistors	ERJ PB3, PB6	14
Current Sensing	Thick Film Chip Resistors / Low Resistance Type	ERJ 2LW, 3LW, 6LW, 2BW,3BW,6BW,8BW,6CW,8CW ERJ 2B, 3B, 6D, 6B, 8B, 14B, 3R, 6R, 8R, 14R, 12R,12Z, ERJ 1TR, L03, L06, L08, L14, L12, L1D, L1W	16
	Current Sensing Resistors, Metal Plate Type	ERJ MS4S, MS4H, MB1S	21
	High Power Chip Resistors / Wide Terminal Type	ERJ A1, B1, B2, B3	25
	Low TCR High Power Chip Resistors / Wide Terminal Type	ERJ D1, D2	29
Small&High Power	Anti-Surge Thick Film Chip Resistors	ERJ PA2, P03, PA3, P06, P08, P14	31
	Anti-Pulse Thick Film Chip Resistors	ERJ T06, T08, T14	34
Anti-Sulfurated	Anti-Sulfurated Thick Film Chip Resistors	ERJ S02, S03, S06, S08, S14, S12, S1D, S1T ERJ U01, U02, U03, U06, U08, U14, U12, U1D, U1T ERJ U6S, U6Q	37
	Anti-Sulfurated Thick Film Chip Resistors / Anti-Surge Type	ERJ UP6, UP8	40
	Anti-Sulfurated High Power Chip Resistors / Wide Terminal Type	ERJ C1	43
Resistor Network/Array	Chip Resistor Array	EXB 14V, 18V, 24V, 28V, N8V, 2HV, 34V, V4V, 38V, V8V, S8V	45
	Anti-Sulfurated Chip Resistor Array	EXB U14, U18, U24, U28, U2H, U34, U38	49
	Chip Resistor Networks	EXB D, E, A, Q	52
	Chip Attenuator	EXB 14AT, 24AT	55
Common specifications	Packaging Methods (Taping)		57
	Recommended Land Pattern		62
	Recommended Soldering Conditions		64
	Standard for Resistance Value and Resistance Tolerance		65

All products in this catalog comply with the RoHS Directive.

The RoHS Directive is “the Directive (2011/65/EU) on the Restriction of the Use of Certain Hazardous Substances in Electrical and Electronic Equipment “ and its revisions.

⚠ Safety Precautions (Common precautions for Fixed Resistors)

- When using our products, no matter what sort of equipment they might be used for, be sure to make a written agreement on the specifications with us in advance. The design and specifications in this catalog are subject to change without prior notice.
- Do not use the products beyond the specifications described in this catalog.
- This catalog explains the quality and performance of the products as individual components. Before use, check and evaluate their operations when installed in your products.
- Install the following systems for a failsafe design to ensure safety if these products are to be used in equipment where a defect in these products may cause the loss of human life or other significant damage, such as damage to vehicles (automobile, train, vessel), traffic lights, medical equipment, aerospace equipment, electric heating appliances, combustion/gas equipment, rotating equipment, and disaster/crime prevention equipment.
- * Systems equipped with a protection circuit and a protection device
- * Systems equipped with a redundant circuit or other system to prevent an unsafe status in the event of a single fault

(1) Precautions for use

- These products are designed and manufactured for general and standard use in general electronic equipment (e.g. AV equipment, home electric appliances, office equipment, information and communication equipment)
- These products are not intended for use in the following special conditions. Before using the products, carefully check the effects on their quality and performance, and determine whether or not they can be used.
 1. In liquid, such as water, oil, chemicals, or organic solvent
 2. In direct sunlight, outdoors, or in dust
 3. In salty air or air with a high concentration of corrosive gas, such as Cl₂, H₂S, NH₃, SO₂, or NO₂
 4. Electric Static Discharge (ESD) Environment
These components are sensitive to static electricity and can be damaged under static shock (ESD). Please take measures to avoid any of these environments.
Smaller components are more sensitive to ESD environment.
 5. Electromagnetic Environment
Avoid any environment where strong electromagnetic waves exist.
 6. In an environment where these products cause dew condensation
 7. Sealing or coating of these products or a printed circuit board on which these products are mounted, with resin or other materials
- These products generate Joule heat when energized. Carefully position these products so that their heat will not affect the other components.
- Carefully position these products so that their temperatures will not exceed the category temperature range due to the effects of neighboring heat-generating components. Do not mount or place heat-generating components or inflammables, such as vinyl-coated wires, near these products.
- Note that non-cleaning solder, halogen-based highly active flux, or water-soluble flux may deteriorate the performance or reliability of the products.
- Carefully select a flux cleaning agent for use after soldering. An unsuitable agent may deteriorate the performance or reliability. In particular, when using water or a water-soluble cleaning agent, be careful not to leave water residues. Otherwise, the insulation performance may be deteriorated.

(2) Precautions for storage

The performance of these products, including the solderability, is guaranteed for a year from the date of arrival at your company, provided that they remain packed as they were when delivered and stored at a temperature of 5 °C to 35 °C and a relative humidity of 45 % to 85 %.

Even within the above guarantee periods, do not store these products in the following conditions. Otherwise, their electrical performance and/or solderability may be deteriorated, and the packaging materials (e.g. taping materials) may be deformed or deteriorated, resulting in mounting failures.

1. In salty air or in air with a high concentration of corrosive gas, such as Cl₂, H₂S, NH₃, SO₂, or NO₂
2. In direct sunlight

<Package markings>

Package markings include the product number, quantity, and country of origin. In principle, the country of origin should be indicated in English.

⚠ Safety Precautions (Common precautions for Surface Mount Resistors)

The following are precautions for individual products. Please also refer to the common precautions for Fixed Resistors in this catalog.

1. Take measures against mechanical stress during and after mounting of Surface Mount Resistors (hereafter called the resistors) so as not to damage their electrodes and protective coatings.
Be careful not to misplace the resistors on the land patterns. Otherwise, solder bridging may occur.
2. Keep the rated power and ambient temperature within the specified derating curve.
Some circuit boards, wiring patterns, temperatures of heat generated by adjacent components, or ambient temperatures can become factors in the rise of the temperature of the resistors, regardless of the level of power applied. Therefore, check the conditions before use and optimize them so as not to damage the boards and peripheral components.
Make sure to contact us before using the resistors under special conditions.
3. If a transient load (heavy load in a short time) like a pulse is expected to be applied, check and evaluate the operations of the resistors when installed in your products before use.
Never exceed the rated power. Otherwise, the performance and/or reliability of the resistors may be impaired.
4. Before using halogen-based or other high-activity flux, check the possible effects of the flux residues on the performance and reliability of the resistors.
5. When soldering with a soldering iron, never touch the resistors' bodies with the tip of the soldering iron. When using a soldering iron with a high temperature tip, finish soldering as quickly as possible (within three seconds at 350 °C max.).
6. As the amount of applied solder becomes larger, the mechanical stress applied to the resistors increases, causing problems such as cracks and faulty characteristics. Avoid applying an excessive amounts of solder.
7. When the resistors' protective coatings are chipped, flawed, or removed, the characteristics of the resistors may be impaired. Take special care not to apply mechanical shock during automatic mounting or cause damage during handling of the boards with the resistors mounted.
8. Do not apply shock to the resistors or pinch them with a hard tool (e.g. pliers and tweezers). Otherwise, the resistors' protective coatings and bodies may be chipped, affecting their performance.
9. Avoid excessive bending of printed circuit boards in order to protect the resistors from abnormal stress.
10. Do not immerse the resistors in solvent for a long time. Before using solvent, carefully check the effects of immersion.
11. Transient voltage
If there is a possibility that the transient phenomenon (significantly high voltage applied in a short time) may occur or that a high voltage pulse may be applied, make sure to evaluate and check the characteristics of Fixed Metal (Oxide) Film Resistors mounted on your product rather than only depending on the calculated power limit or steady-state conditions to complete the design or decide to use the resistors.
12. Do not apply excessive tension to the terminals.

Thick Film Chip Resistors

Type: **ERJ XG, 1G, 2G, 3G, 6G, 8G, 14, 12, 12Z, 1T**



Features

- Small size and lightweight
- High reliability
Metal glaze thick film resistive element and three layers of electrodes
- Compatible with placement machines
Taping packaging available
- Suitable for both reflow and flow soldering
- Reference Standards
IEC 60115-8, JIS C 5201-8, JEITA RC-2134C
- AEC-Q200 qualified (Exemption ERJXG)
- RoHS compliant

As for Packaging Methods, Land Pattern, Soldering Conditions and Safety Precautions,
Please see Data Files

Explanation of Part Numbers

- ERJXGN, 1GN, 2GE, 3GE, 6GE, 8GE, 14, 12, 12Z, 1T Series, $\pm 5\%$

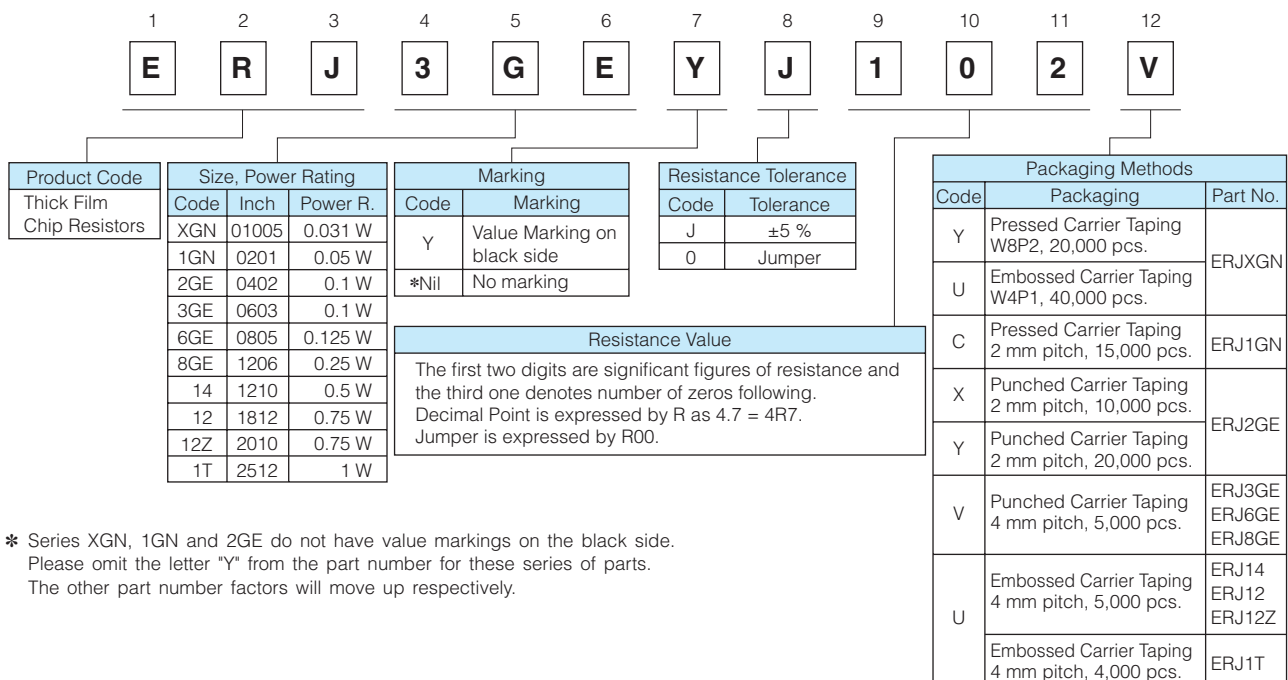

* Series XGN, 1GN and 2GE do not have value markings on the black side.
Please omit the letter "Y" from the part number for these series of parts.
The other part number factors will move up respectively.

Construction

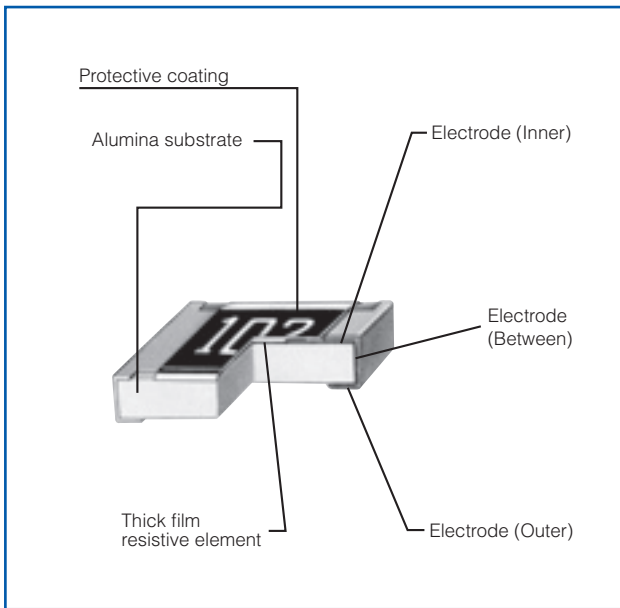

Dimensions in mm (not to scale)

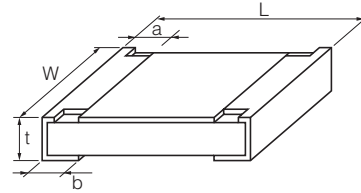

Part No.	Dimensions (mm)					Mass (Weight) (g/1000 pcs.)
	L	W	a	b	t	
ERJXG	0.40 ^{±0.02}	0.20 ^{±0.02}	0.10 ^{±0.03}	0.10 ^{±0.03}	0.13 ^{±0.02}	0.04
ERJ1G	0.60 ^{±0.03}	0.30 ^{±0.03}	0.10 ^{±0.05}	0.15 ^{±0.05}	0.23 ^{±0.03}	0.15
ERJ2G	1.00 ^{±0.05}	0.50 ^{±0.05}	0.20 ^{±0.10}	0.25 ^{±0.05}	0.35 ^{±0.05}	0.8
ERJ3G	1.60 ^{±0.15}	0.80 ^{+0.15/-0.05}	0.30 ^{±0.20}	0.30 ^{±0.15}	0.45 ^{±0.10}	2
ERJ6G	2.00 ^{±0.20}	1.25 ^{±0.10}	0.40 ^{±0.20}	0.40 ^{±0.20}	0.60 ^{±0.10}	4
ERJ8G	3.20 ^{+0.05/-0.20}	1.60 ^{+0.05/-0.15}	0.50 ^{±0.20}	0.50 ^{±0.20}	0.60 ^{±0.10}	10
ERJ14	3.20 ^{±0.20}	2.50 ^{±0.20}	0.50 ^{±0.20}	0.50 ^{±0.20}	0.60 ^{±0.10}	16
ERJ12	4.50 ^{±0.20}	3.20 ^{±0.20}	0.50 ^{±0.20}	0.50 ^{±0.20}	0.60 ^{±0.10}	27
ERJ12Z	5.00 ^{±0.20}	2.50 ^{±0.20}	0.60 ^{±0.20}	0.60 ^{±0.20}	0.60 ^{±0.10}	27
ERJ1T	6.40 ^{±0.20}	3.20 ^{±0.20}	0.65 ^{±0.20}	0.60 ^{±0.20}	0.60 ^{±0.10}	45

Ratings

[For Resistor]

Part No. (inch size)	Power Rating ⁽³⁾ at 70 °C (W)	Limiting Element Voltage ⁽¹⁾ (V)	Maximum Overload Voltage ⁽²⁾ (V)	Resistance Tolerance (%)	Resistance Range (Ω)	T.C.R. (× 10 ⁻⁶ /°C)	Category Temperature Range (°C)	AEC-Q200 Grade
ERJXG (01005)	0.031	15	30	±5	1 to 1 M (E24)	<10 Ω : -100 to +600 10 Ω to 100 Ω : ±300 100 Ω ≤ : ±200	-55 to +125	-
ERJ1G (0201)	0.05	25	50	±5	1 to 10 M (E24)	<10 Ω : -100 to +600 10 Ω to 1 M Ω : ±200 1 M Ω < : -400 to +150	-55 to +125	Grade 1
ERJ2G (0402)	0.1	50	100	±5	1 to 10 M (E24)		-55 to +155	Grade 0
ERJ3G (0603)	0.1	75	150	±5	1 to 10 M (E24)		-55 to +155	Grade 0
ERJ6G (0805)	0.125	150	200	±5	1 to 10 M (E24)		-55 to +155	Grade 0
ERJ8G (1206)	0.25	200	400	±5	1 to 10 M (E24)		-55 to +155	Grade 0
ERJ14 (1210)	0.5	200	400	±5	1 to 10 M (E24)		-55 to +155	Grade 0
ERJ12 (1812)	0.75	200	500	±5	1 to 10 M (E24)		-55 to +155	Grade 0
ERJ12Z (2010)	0.75	200	500	±5	1 to 10 M (E24)		-55 to +155	Grade 0
ERJ1T (2512)	1	200	500	±5	1 to 1 M (E24)		-55 to +155	Grade 0

- (1) Rated Continuous Working Voltage (RCWW) shall be determined from $RCWW = \sqrt{\text{Power Rating} \times \text{Resistance Values}}$, or Limiting Element Voltage listed above, whichever less.
 (2) Overload Test Voltage (OTV) shall be determined from $OTV = \text{Specified Magnification (refer to performance)} \times RCWW$ or Maximum Overload Voltage listed above, whichever less.
 (3) Use it on the condition that the case temperature is below the upper category temperature.

[For Jumper]

Part No. (inch size)	Rated Current (A)	Maximum Overload Current ⁽¹⁾ (A)
ERJXG (01005)	0.5	1
ERJ1G (0201)		
ERJ2G (0402)		
ERJ3G (0603)	1	2
ERJ6G (0805)		
ERJ8G (1206)		
ERJ14 (1210)	2	4
ERJ12 (1812)		
ERJ12Z (2010)		
ERJ1T (2512)		

(1) Overload test current

Power Derating Curve

For resistors operated in ambient temperatures above 70 °C, power rating shall be derated in accordance with the figure below.

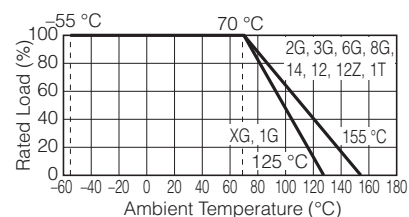

Performance

Test Item	Performance Requirements		Test Conditions
	Resistor type	Jumper type	
Resistance	Within Specified Tolerance	50 mΩ or less	20 °C
T. C. R.	Within Specified T. C. R.	50 mΩ or less	+25 °C/+155 °C (ERJXG, ERJ1G : +25 °C/+125 °C)
Overload	±2 %	50 mΩ or less	Rated Voltage × 2.5, 5 s Jumper type : Max. Overload Current, 5 s
Resistance to Soldering Heat	±1 %	50 mΩ or less	270 °C, 10 s
Rapid Change of Temperature	±1 %	50 mΩ or less	-55 °C (30min.) / +155 °C (ERJXG, ERJ1G : +125 °C) (30min.), 100 cycles
High Temperature Exposure	±1 %	50 mΩ or less	+155 °C (ERJXG, ERJ1G : +125 °C) , 1000 h
Damp Heat, Steady State	±1 %	50 mΩ or less	60 °C, 90 % to 95 %RH, 1000 h
Load Life in Humidity	±3 %	50 mΩ or less	60 °C, 90 % to 95 %RH, Rated Voltage (Jumper type: Rated Current), 1.5 h ON/0.5 h OFF cycle, 1000 h
Endurance at 70 °C	±3 %	50 mΩ or less	70 °C, Rated Voltage(Jumper type: Rated Current), 1.5 h ON/0.5 h OFF cycle, 1000 h

Precision Thick Film Chip Resistors

Type: **ERJ XG, 1G**
ERJ 1R, 2R, 3R, 6R
ERJ 3E, 6E, 8E, 14, 12, 1T



Features

- Small size and lightweight
- High reliability
Metal glaze thick film resistive element and three layers of electrodes
- Compatible with placement machines
Taping packaging available
- Suitable for both reflow and flow soldering
- Low Resistance Tolerance
ERJXG, 1G, 2R, 3E, 6E, 8E, 14, 12, 1T Series : ±1 %
ERJ1R, 2R, 3R, 6R Series : ±0.5 %
- Reference Standards
IEC 60115-8, JIS C 5201-8, JEITA RC-2134C
- AEC-Q200 qualified (Exemption ERJXG, ERJ1R)
- RoHS compliant

■ **As for Packaging Methods, Land Pattern, Soldering Conditions and Safety Precautions,**
 Please see Data Files

Explanation of Part Numbers

- ERJ1R, 2R, 3R, 6R Series, ±0.5 %

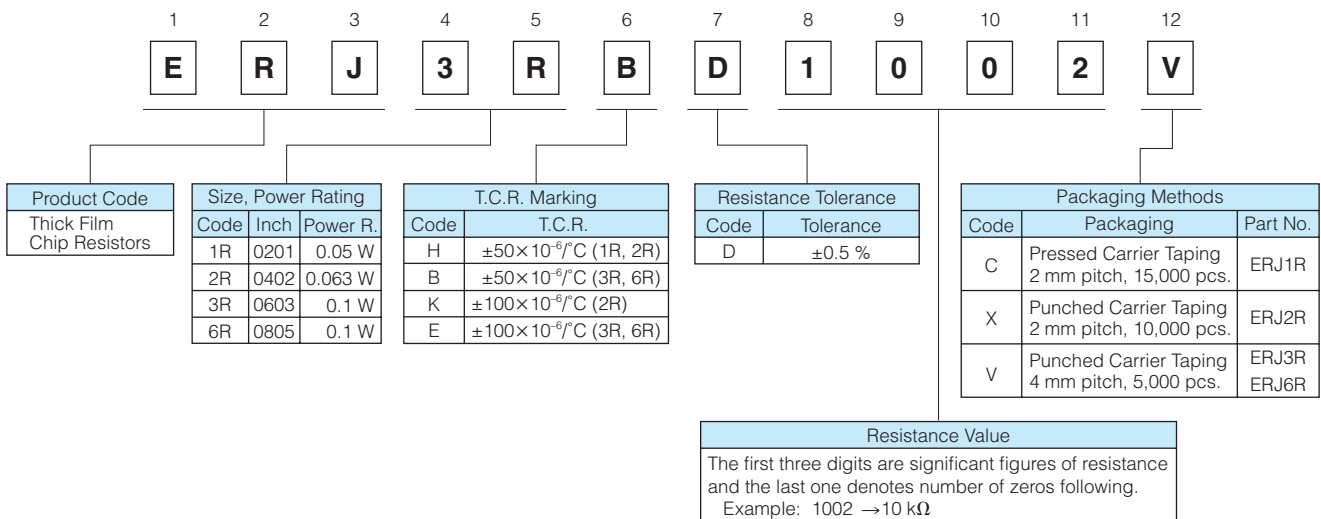

- ERJXGN, 1GN, 2RC, 2RK, 3EK, 6EN, 8EN, 14N, 12N, 12S, 1TN Series, $\pm 1\%$

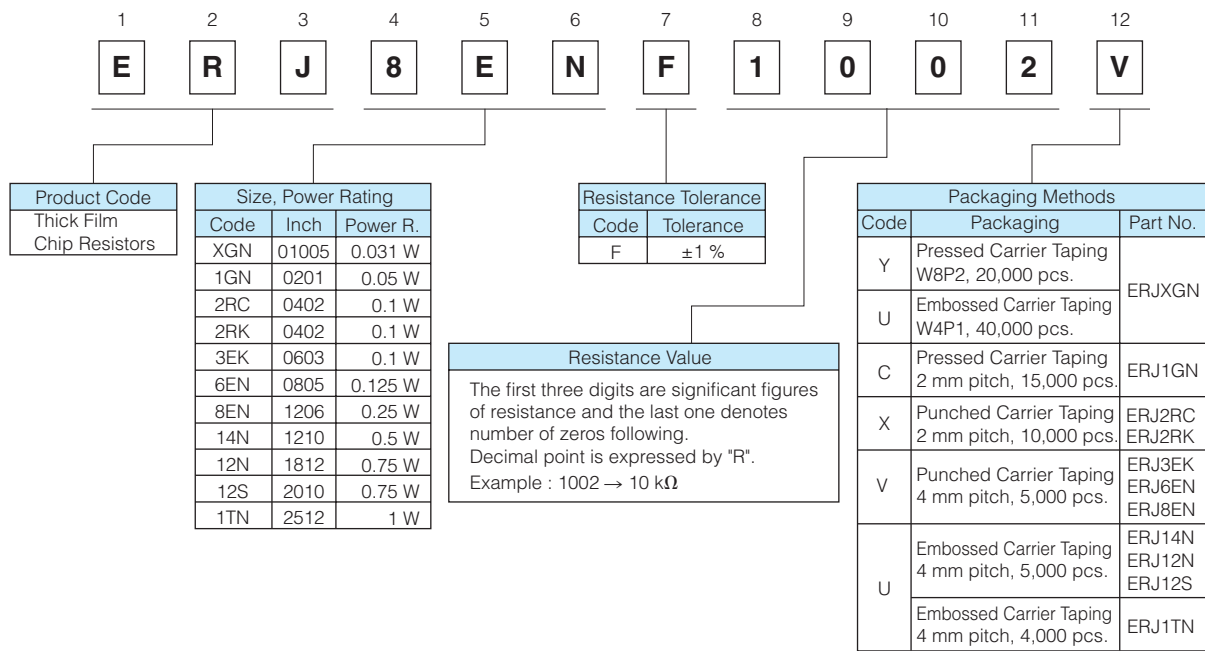

Construction

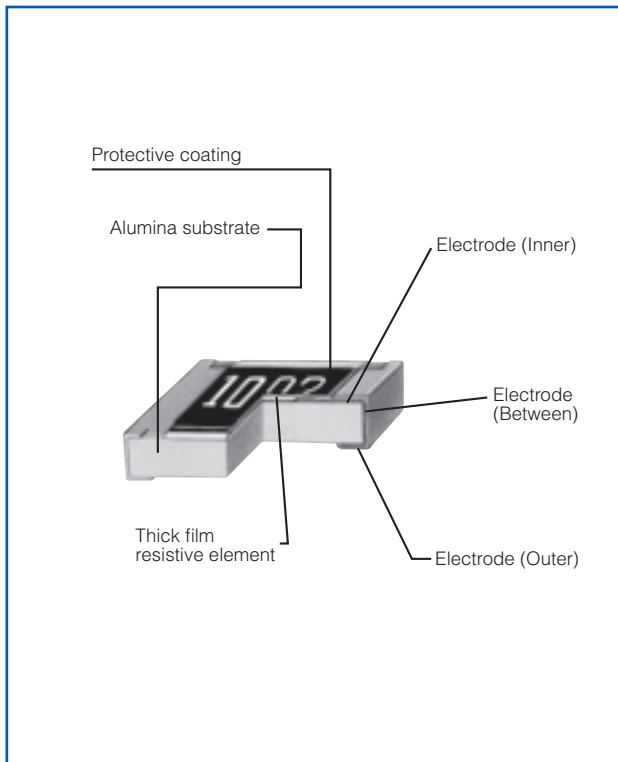

Dimensions in mm (not to scale)

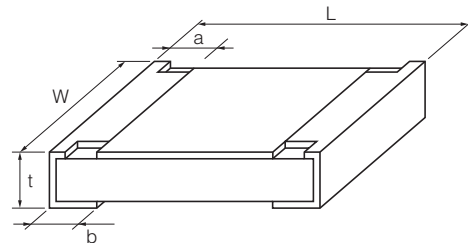

Part No.	Dimensions (mm)					Mass (Weight) [g/1000 pcs.]
	L	W	a	b	t	
ERJXG	0.40 ^{+0.02}	0.20 ^{+0.02}	0.10 ^{+0.03}	0.10 ^{+0.03}	0.13 ^{+0.02}	0.04
ERJ1G, 1R	0.60 ^{+0.03}	0.30 ^{+0.03}	0.10 ^{+0.05}	0.15 ^{+0.05}	0.23 ^{+0.03}	0.15
ERJ2R□	1.00 ^{+0.05}	0.50 ^{+0.05}	0.20 ^{+0.10}	0.25 ^{+0.05}	0.35 ^{+0.05}	0.8
ERJ3R□ ERJ3EK	1.60 ^{+0.15}	0.80 ^{+0.15}	0.30 ^{+0.20}	0.30 ^{+0.15}	0.45 ^{+0.10}	2
ERJ6R□ ERJ6EN	2.00 ^{+0.20}	1.25 ^{+0.10}	0.40 ^{+0.20}	0.40 ^{+0.20}	0.60 ^{+0.10}	4
ERJ8EN	3.20 ^{+0.05} _{-0.20}	1.60 ^{+0.05} _{-0.15}	0.50 ^{+0.20}	0.50 ^{+0.20}	0.60 ^{+0.10}	10
ERJ14N	3.20 ^{+0.20}	2.50 ^{+0.20}	0.50 ^{+0.20}	0.50 ^{+0.20}	0.60 ^{+0.10}	16
ERJ12N	4.50 ^{+0.20}	3.20 ^{+0.20}	0.50 ^{+0.20}	0.50 ^{+0.20}	0.60 ^{+0.10}	27
ERJ12S	5.00 ^{+0.20}	2.50 ^{+0.20}	0.60 ^{+0.20}	0.60 ^{+0.20}	0.60 ^{+0.10}	27
ERJ1TN	6.40 ^{+0.20}	3.20 ^{+0.20}	0.65 ^{+0.20}	0.60 ^{+0.20}	0.60 ^{+0.10}	45

Ratings

<±0.5 %>

Part No. (inch size)	Power Rating at 70 °C ⁽⁴⁾ (W)	Limiting Element Voltage ⁽¹⁾ (V)	Maximum Overload Voltage ⁽²⁾ (V)	Resistance Tolerance (%)	Resistance Range (Ω)	T.C.R. (×10 ⁻⁶ /°C)	Category Temperature Range (°C)	AEC-Q200 Grade
ERJ1RH (0201)	0.05	15	30	±0.5	1k to 1M (E24, E96)	±50	-55 to +125	-
ERJ2RH (0402)	0.063	50	100	±0.5	100 to 100k (E24, E96)	±50	-55 to +155	Grade 0
ERJ2RK (0402)	0.063	50	100	±0.5	10 to 97.6 102k to 1M (E24, E96)	±100	-55 to +155	Grade 0
ERJ3RB (0603)	0.1	50	100	±0.5	100 to 100k (E24, E96)	±50	-55 to +155	Grade 0
ERJ3RE (0603)	0.1	50	100	±0.5	10 to 97.6 102k to 1M (E24, E96)	±100	-55 to +155	Grade 0
ERJ6RB (0805)	0.1	150	200	±0.5	100 to 100k (E24, E96)	±50	-55 to +155	Grade 0
ERJ6RE (0805)	0.1	150	200	±0.5	10 to 97.6 102k to 1M (E24, E96)	±100	-55 to +155	Grade 0

<±1 %>

Part No. (inch size)	Power Rating at 70 °C ⁽⁴⁾ (W)	Limiting Element Voltage ⁽¹⁾ (V)	Maximum Overload Voltage ⁽²⁾ (V)	Resistance Tolerance (%)	Resistance Range (Ω)	T.C.R. (×10 ⁻⁶ /°C)	Category Temperature Range (°C)	AEC-Q200 Grade
ERJXGN (01005)	0.031	15	30	±1	10 to 1M ⁽³⁾ (E24, E96)	<100 Ω : ±300 100 Ω ≤ : ±200	-55 to +125	-
ERJ1GN (0201)	0.05	25	50	±1	10 to 1M ⁽³⁾ (E24, E96)	±200	-55 to +125	Grade 1
ERJ2RC (0402)	0.1	50	100	±1	1 to 9.76 (E24, E96)	-100 to +600	-55 to +155	Grade 0
ERJ2RK (0402)	0.1	50	100	±1	10 to 1M (E24, E96)	±100	-55 to +155	Grade 0
ERJ3EK (0603)	0.1	75	150	±1	10 to 1M (E24, E96)	±100	-55 to +155	Grade 0
ERJ6EN (0805)	0.125	150	200	±1	10 to 2.2M (E24, E96)	±100	-55 to +155	Grade 0
ERJ8EN (1206)	0.25	200	400	±1	10 to 2.2M (E24, E96)	±100	-55 to +155	Grade 0
ERJ14N (1210)	0.5	200	400	±1	10 to 1M (E24, E96)	±100	-55 to +155	Grade 0
ERJ12N (1812)	0.75	200	500	±1	10 to 1M (E24, E96)	±100	-55 to +155	Grade 0
ERJ12S (2010)	0.75	200	500	±1	10 to 1M (E24, E96)	±100	-55 to +155	Grade 0
ERJ1TN (2512)	1	200	500	±1	10 to 1M (E24, E96)	±100	-55 to +155	Grade 0

- (1) Rated Continuous Working Voltage (RCWV) shall be determined from $RCWV = \sqrt{\text{Power Rating} \times \text{Resistance Values}}$, or Limiting Element Voltage listed above, whichever less.
 (2) Overload Test Voltage (OTV) shall be determined from $OTV = \text{Specified Magnification (refer to performance)} \times RCWV$ or Maximum Overload Voltage listed above, whichever less.
 (3) Please contact us when you need a type with a resistance of less than 10 Ω.
 (4) Use it on the condition that the case temperature is below the upper category temperature.

Power Derating Curve

For resistors operated in ambient temperatures above 70 °C, power rating shall be derated in accordance with the figure on the right.

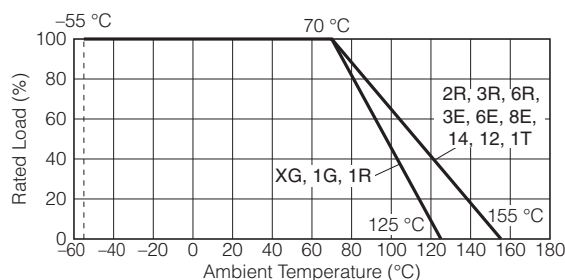

Performance

● ERJ1R, 2R, 3R, 6R Series, $\pm 0.5\%$ (D)

Test Item	Performance Requirements	Test Conditions
Resistance	Within Specified Tolerance	20 °C
T. C. R.	Within Specified T. C. R.	+25 °C/+125 °C
Overload	$\pm 2\%$	Rated Voltage \times 2.5, 5 s
Resistance to Soldering Heat	$\pm 1\%$	270 °C, 10 s
Rapid Change of Temperature	$\pm 1\%$	-55 °C (30min.) / +155 °C (ERJ1R : +125 °C) (30min.), 100 cycles
High Temperature Exposure	$\pm 1\%$	+155 °C (ERJ1R : +125 °C) , 1000 h
Damp Heat, Steady State	$\pm 1\%$	60 °C, 90 % to 95 %RH, 1000 h
Load Life in Humidity	$\pm 2\%$ ERJ1R: $\pm 3\%$	60 °C, 90 % to 95 %RH, Rated Voltage, 1.5 h ON/0.5 h OFF cycle, 1000 h
Endurance at 70 °C	$\pm 2\%$ ERJ1R: $\pm 3\%$	70 °C, Rated Voltage, 1.5 h ON/0.5 h OFF cycle, 1000 h

● ERJXGN, 1GN, 2RC, 2RK, 3EK, 6EN, 8EN, 14N, 12N, 12S, 1TN Series, $\pm 1\%$ (F)

Test Item	Performance Requirements	Test Conditions
Resistance	Within Specified Tolerance	20 °C
T. C. R.	Within Specified T. C. R.	+25 °C/+155 °C (ERJXG, ERJ1G : +25 °C/+125 °C)
Overload	$\pm 2\%$	Rated Voltage \times 2.5, 5 s
Resistance to Soldering Heat	$\pm 1\%$	270 °C, 10 s
Rapid Change of Temperature	$\pm 1\%$	-55 °C (30min.) / +155 °C (ERJXG, ERJ1G : +125 °C) (30min.), 100 cycles
High Temperature Exposure	$\pm 1\%$	+155 °C (ERJXG, ERJ1G : +125 °C) , 1000 h
Damp Heat, Steady State	$\pm 1\%$	60 °C, 90 % to 95 %RH, 1000 h
Load Life in Humidity	$\pm 2\%$ ERJXG, ERJ1G: $\pm 3\%$	60 °C, 90 % to 95 %RH, Rated Voltage, 1.5 h ON/0.5 h OFF cycle, 1000 h
Endurance at 70 °C	$\pm 2\%$ ERJXG, ERJ1G: $\pm 3\%$	70 °C, Rated Voltage, 1.5 h ON/0.5 h OFF cycle, 1000 h

Metal Film (Thin Film) Chip Resistors, High Reliability Type

Type: **ERA 1A, 2A, 3A, 6A, 8A**

Features

- High reliability Stable at high temperature and humidity (85 °C 85 %RH rated load, Category temperature range : -55 °C to +155 °C)
- High accuracy Small resistance tolerance and Temperature Coefficient of Resistance
- High performance Low current noise, excellent linearity
- Reference Standard IEC 60115-8, JIS C 5201-8, EIAJ RC-2133B
- AEC-Q200 qualified
- RoHS compliant

As for Packaging Methods, Land Pattern, Soldering Conditions and Safety Precautions,
Please see Data Files

Explanation of Part Numbers

● E24 Series

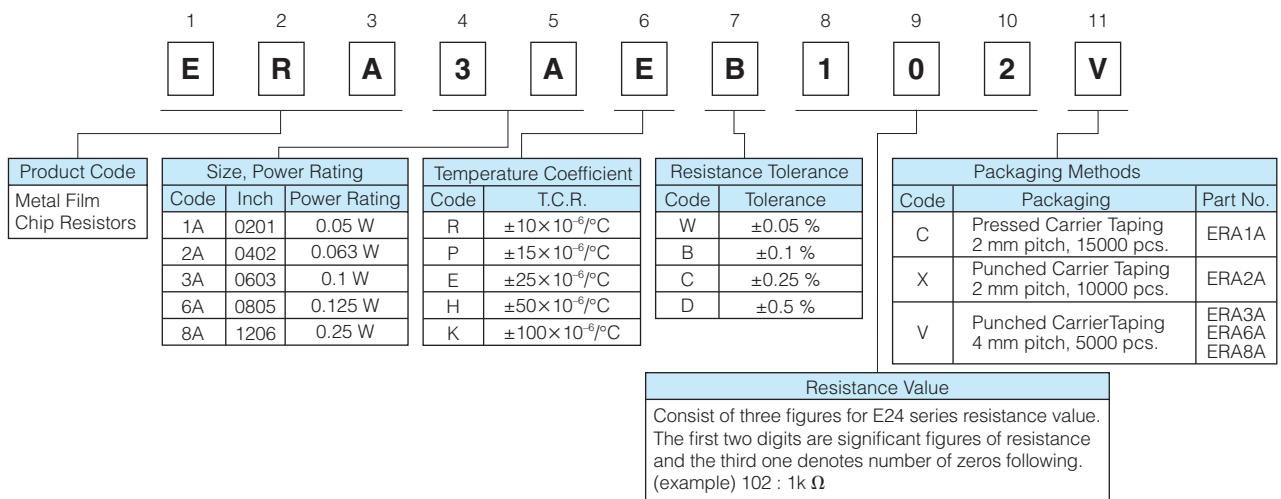

● E96 Series and other Resistance values

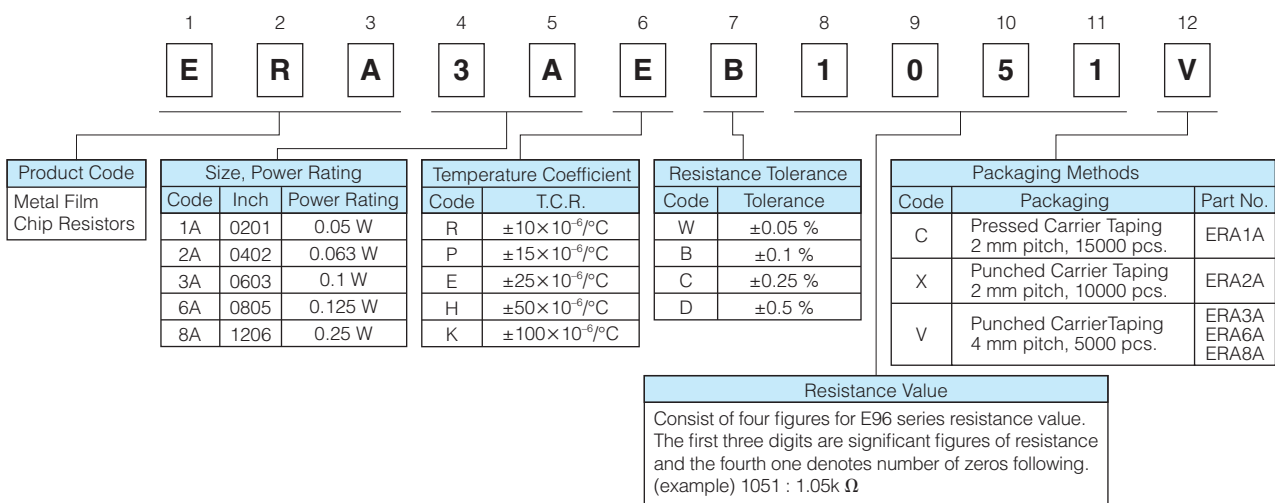

note : Duplicated resistance values as E24 series part numbers shall follow E24 part numbers. (apply three digit resistance value)

Construction

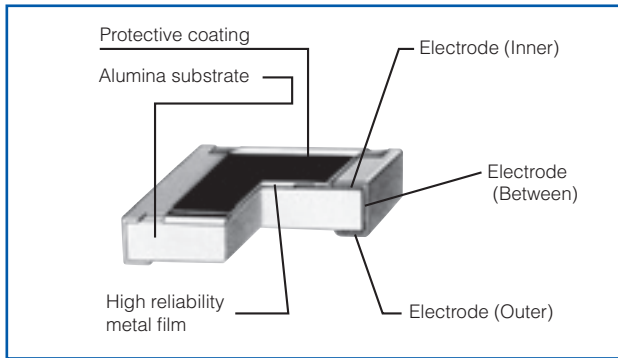

Dimensions in mm (not to scale)

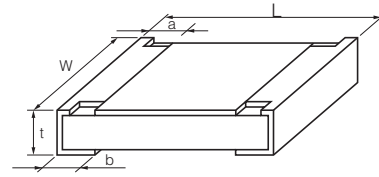

Part No. (inch size)	Dimensions (mm)					Mass (Weight) [g/1000pcs.]
	L	W	a	b	t	
ERA1A (0201)	0.60 ^{±0.03}	0.30 ^{±0.03}	0.15 ^{±0.05}	0.15 ^{±0.05}	0.23 ^{±0.03}	0.14
ERA2A (0402)	1.00 ^{±0.10}	0.50 ^{±0.05}	0.15 ^{±0.10}	0.25 ^{±0.10}	0.35 ^{±0.05}	0.6
ERA3A (0603)	1.60 ^{±0.20}	0.80 ^{±0.20}	0.30 ^{±0.20}	0.30 ^{±0.20}	0.45 ^{±0.10}	2
ERA6A (0805)	2.00 ^{±0.20}	1.25 ^{±0.10}	0.40 ^{±0.25}	0.40 ^{±0.25}	0.50 ^{±0.10}	4
ERA8A (1206)	3.20 ^{±0.20}	1.60 ^{±0.15}	0.50 ^{±0.25}	0.50 ^{±0.25}	0.60 ^{±0.10}	8

Ratings

Part No. (inch size)	Power Rating at 85 °C (W)	Limiting Element Voltage ⁽¹⁾ (V)	Maximum Overload Voltage ⁽²⁾ (V)	Part No. (detail)	Resistance Tolerance (%)	T.C.R. (×10 ⁻⁶ /°C)	Resistance Range ⁽³⁾⁽⁴⁾ (Ω)	Category Temperature Range (°C)
ERA1A (0201)	0.05	25	50	ERA1AEB	±0.1	±25	100 to 10k (E24, E96)	-55 to +155
				ERA1AEC	±0.25			
				ERA1ARC	±0.25			
				ERA1ARB	±0.1	±10	100 to 10k (E24, E96)	
				ERA1ARW	±0.05			
ERA2A (0402)	0.063	50	100	ERA2AKD	±0.5	±100	10 to 46.4 (E24, E96)	
				ERA2AED	±0.5			
				ERA2AEC	±0.25	±25	47 to 100k (E24, E96)	
				ERA2AEB	±0.1			
				ERA2APC	±0.25			
				ERA2APB	±0.1	±15	200 to 47k (E24, E96)	
				ERA2ARC	±0.25			
ERA2ARB	±0.1	±10	200 to 47k (E24, E96)					
ERA3A (0603)	0.1	75	150	ERA3AHD	±0.5	±50	10 to 46.4 (E24, E96)	
				ERA3AED	±0.5			
				ERA3AEC	±0.25	±25	47 to 330k (E24, E96)	
				ERA3AEB	±0.1			
				ERA3APC	±0.25			
				ERA3APB	±0.1	±15	470 to 100k (E24, E96)	
				ERA3ARC	±0.25			
				ERA3ARB	±0.1	±10	1k to 100k (E24, E96)	
ERA3ARW	±0.05							
ERA6A (0805)	0.125	100	200	ERA6AHD	±0.5	±50	10 to 46.4 (E24, E96)	
				ERA6AED	±0.5			
				ERA6AEC	±0.25	±25	47 to 1M (E24, E96)	
				ERA6AEB	±0.1			
				ERA6APC	±0.25			
				ERA6APB	±0.1	±15	470 to 100k (E24, E96)	
				ERA6ARC	±0.25			
ERA6ARB	±0.1	±10	1k to 100k (E24, E96)					
ERA6ARW	±0.05							
ERA8A (1206)	0.25	150	300	ERA8AHD	±0.5	±50	10 to 46.4 (E24, E96)	
				ERA8AED	±0.5			
				ERA8AEC	±0.25	±25	47 to 1M (E24, E96)	
				ERA8AEB	±0.1			
				ERA8APC	±0.25			
				ERA8APB	±0.1	±15	470 to 100k (E24, E96)	
				ERA8ARC	±0.25			
				ERA8ARB	±0.1	±10	1k to 100k (E24, E96)	
ERA8ARW	±0.05							

(1) Rated Continuous Working Voltage (RCWV) shall be determined from $RCWV = \sqrt{\text{Rated Power} \times \text{Resistance Values}}$, or Limiting Element Voltage listed above, whichever less.
 (2) Overload (Short-time Overload) Test Voltage (SOTV) shall be determined from $SOTV = 2.5 \times RCWV$ or max. Overload Voltage listed above whichever less.
 (3) E192 series resistance values are also available. Please contact us for details.
 (4) Duplicated resistance values between E96, E192 and E24 series shall follow E24 Part Numbers. (apply three digit resistance value)

Power Derating Curve

For resistors operated in ambient temperatures above 85 °C, power rating shall be derated in accordance with the figure on the right.

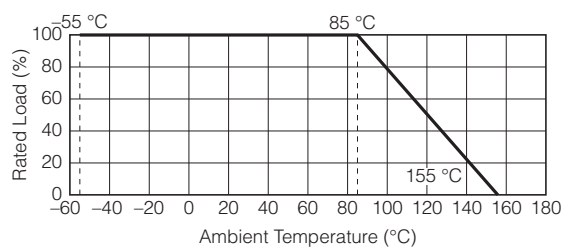

High Precision Thick Film Chip Resistors



Type: **ERJ PB3, PB6**

Features

- Achieve the resistance tolerance $\pm 0.1\%$ with high reliability metal glaze thick film resistor
- Guarantee the temperature coefficient of Resistance $\pm 50 \times 10^{-6}/^{\circ}\text{C}$ in high resistance range up to $1\text{ M}\Omega$
- Suitable for both reflow and flow soldering
- High power ... 0.20 W : 0603 inch / 1608 mm size (ERJPB3)
 0.25 W : 0805 inch / 2012 mm size (ERJPB6)
- Reference Standards... IEC 60115-8, JIS C 5201-8, JEITA RC-2134C
- AEC-Q200 qualified
- RoHS compliant

■ **As for Packaging Methods, Land Pattern, Soldering Conditions and Safety Precautions,**
 Please see Data Files

Explanation of Part Numbers

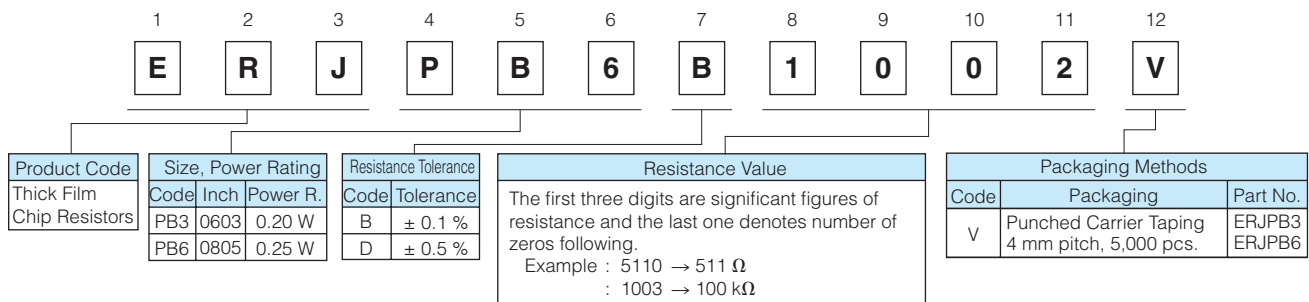

Construction

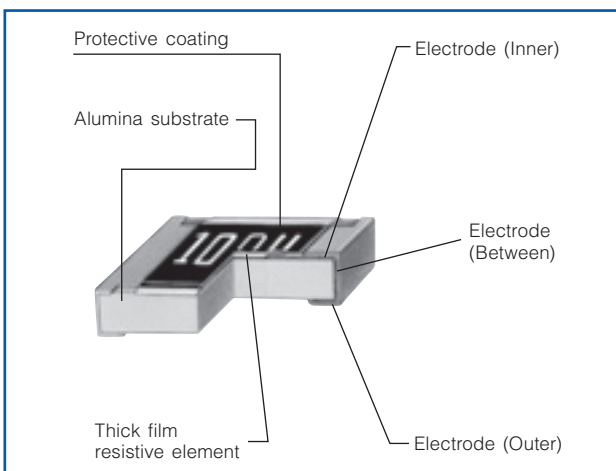

Dimensions in mm (not to scale)

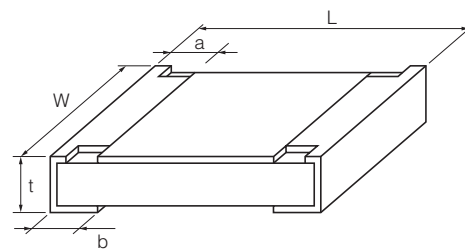

Part No.	Dimensions (mm)					Mass (Weight) [g/1000 pcs.]
	L	W	a	b	t	
ERJPB3	$1.60^{+0.15}$	$0.80^{+0.15}_{-0.05}$	$0.15^{+0.15}_{-0.10}$	$0.25^{+0.10}$	$0.45^{+0.10}$	2
ERJPB6	$2.00^{+0.20}$	$1.25^{+0.10}$	$0.25^{+0.20}$	$0.40^{+0.20}$	$0.60^{+0.10}$	4

Ratings

Part No. (inch size)	Power Rating ⁽³⁾ at 70 °C (W)	Limiting Element Voltage ⁽¹⁾ (V)	Maximum Overload Voltage ⁽²⁾ (V)	Resistance Tolerance (%)	Resistance Range (Ω)	T.C.R. ($\times 10^{-6}/^{\circ}\text{C}$)	Category Temperature Range (°C)	AEC-Q200 Grade
ERJPB3 (0603)	0.20	150	200	±0.1 ±0.5	200 to 100 k (E24, E96)	±50	-55 to +155	Grade 0
ERJPB6 (0805)	0.25	150	200	±0.1 ±0.5	200 to 1 M (E24, E96)	±50	-55 to +155	Grade 0

- (1) Rated Continuous Working Voltage (RCWV) shall be determined from $\text{RCWV} = \sqrt{\text{Power Rating} \times \text{Resistance Values}}$, or Limiting Element Voltage listed above, whichever less.
 (2) Overload Test Voltage (OTV) shall be determined from $\text{OTV} = \text{Specified Magnification (refer to performance)} \times \text{RCWV}$ or Maximum Overload Voltage listed above, whichever less.
 (3) Use it on the condition that the case temperature is below the upper category temperature.

Power Derating Curve

For resistors operated in ambient temperatures above 70 °C, power rating shall be derated in accordance with the figure on the right.

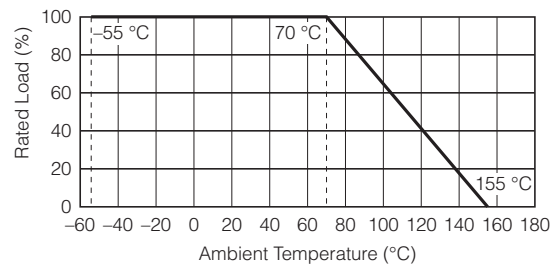

Performance

Test Item	Performance Requirements	Test Conditions
Resistance	Within Specified Tolerance	20 °C
T. C. R.	Within Specified T. C. R.	+25 °C/+125 °C
Overload	±0.5 %	Rated Voltage × 2.0, 5 s
Resistance to Soldering Heat	±0.5 %	270 °C, 10 s
Rapid Change of Temperature	±0.5 %	-55 °C (30min.) / +155 °C (30min.), 100 cycles
High Temperature Exposure	±0.5 %	+155 °C, 1000 h
Damp Heat, Steady State	±0.5 %	60 °C, 90 % to 95 %RH, 1000 h
Load Life in Humidity	±0.5 %	60 °C, 90 % to 95 %RH, Rated Voltage, 1.5 h ON / 0.5 h OFF cycle, 1000 h
Endurance at 70 °C	±0.5 %	70 °C, Rated Voltage, 1.5 h ON / 0.5 h OFF cycle, 1000 h

Thick Film Chip Resistors / Low Resistance Type

Type: **ERJ 2LW, 3LW, 6LW**
2BW, 3BW, 6BW,
8BW, 6CW, 8CW
ERJ 2B, 3B, 6D, 6B, 8B,
14B, 3R, 6R, 8R, 14R,
12R, 12Z, 1TR
ERJ L03, L06, L08, L14,
L12, L1D, L1W



Features

- Current Sensing resistor
- Small size and lightweight
- Realize both low-resistance & High-precision by original thick film resistive element & special electrode structure
- Suitable for both reflow and flow soldering
- Realize High-power by double-sided resistive elements structure that aimed to suppress temperature rising : ERJ2LW, 3LW, 6LW, 2BW, 3BW, 6BW, 8BW, 6CW, 8CW
- Low TCR : $\pm 75 \times 10^{-6} / ^\circ\text{C}$ (ERJ6CW, 8CW)
- Low Resistance Value : Thick film resistors available from 5m Ω (ERJ3LW, 6LW)
- Reference Standards : IEC 60115-8, JIS C 5201-8, JEITA RC-2144
- AEC-Q200 qualified
- RoHS compliant

As for Packaging Methods, Land Pattern, Soldering Conditions and Safety Precautions,
 Please see Data Files

Explanation of Part Numbers

- ERJ2LW, 3LW, 6LW, 2BW, 3BW, 6BW, 8BW, 6CW, 8CW
 <High power (double-sided resistive elements structure) type>

	1	2	3	4	5	6	7	8	9	10	11	12
	E	R	J	2	B	W	G	R	0	4	7	X

Product Code	Code	Inch	Power Rating	Resistance Value	Resistance Tolerance		Resistance Value	Packaging Methods			
					Code	Tolerance		Code	Packaging	Part No.	
Thick Film Chip Resistors	2LW	0402	0.2 W	10m Ω	D	$\pm 0.5\%$ *	Shown by 4 digits or letters. (Ex.) R047 : 0.047 Ω =47m Ω	X	Pressed Carrier Taping 2 mm pitch, 10,000 pcs.	ERJ2LW	
	3LW	0603	0.25 W	5m Ω , 10m Ω	F	$\pm 1\%$				ERJ2BW	
	6LW	0805	0.5 W	5, 6, 7, 8, 9m Ω	G	$\pm 2\%$		V	Punched Carrier Taping 4 mm pitch, 5,000 pcs.	ERJ3LW	
	2BW	0402	0.25 W	47m Ω to 100m Ω	J	$\pm 5\%$				ERJ6LW	
	3BW	0603	0.33 W	20m Ω to 100m Ω	* Please refer to the rating table for the resistance tolerance					ERJ3BW	
	6BW	0805	0.5 W	10m Ω to 100m Ω						ERJ6BW	
	8BW	1206	1 W	10m Ω to 100m Ω						ERJ8BW	
	6CW	0805	0.5 W	10m Ω to 30m Ω						ERJ6CW	
8CW	1206	1 W	10m Ω to 50m Ω	ERJ8CW							

- ERJ2BS/2BQ, 3BS/3BQ, 6BS/6BQ, 8BS/8BQ, 14BS/14BQ, 6D, 3R, 6R, 8R, 14R, 12R, 12Z, 1TR
<High power type/Standard type>

1	2	3	4	5	6	7	8	9	10	11
E	R	J	8	R	Q	F	R	2	2	V

Product Code	Size, Power Rating			Resistance Value		Resistance Tolerance		Packaging Methods		
Thick Film Chip Resistors	Type	Inch	Power R.	Code	Res. Value	Code	Tolerance	Code	Packaging	Part No.
	2B	0402	0.166 W	S	0.1 Ω to 0.2 Ω	D	± 0.5 %*	X	Punched Carrier Taping 2 mm pitch, 10,000 pcs.	ERJ2B
	3B	0603	0.25 W	Q	0.22 Ω to 9.1 Ω*	F	± 1 %	V	Punched Carrier Taping 4 mm pitch, 5,000 pcs.	ERJ3B/3R ERJ6D/6B/6R ERJ8B/8R
	3R	0603	0.1 W	* 2B : 0.22 Ω to 1.0 Ω		G	± 2 %	U	Embossed Carrier Taping 4 mm pitch, 5,000 pcs.	ERJ14B/14R ERJ12R ERJ12Z
	6D	0805	0.5 W			J	± 5 %			
	6B	0805	0.33 W			* Please refer to the rating table for the resistance tolerance				
	6R	0805	0.125 W							
	8B	1206	0.5 W							
	8R	1206	0.25 W							
	14B	1210	0.5 W							
	14R	1210	0.25 W							
	12R	1812	0.5 W							
	12Z	2010	0.5 W							
	1TR	2512	1 W							

Resistance Value	
Shown by 3 digits or letters. Only when it is D (E24, E96) or F (E96), shown by 4 digits or letters. (Ex.) R22 : 0.22 Ω R102 : 0.102 Ω	

- ERJL03, L06, L08, L14, L12, L1D, L1W <Low TCR type>

1	2	3	4	5	6	7	8	9	10	11	12
E	R	J	L	1	4	K	J	5	0	M	U

Product Code	Size, Power Rating			Code	Res. Value	Resistance Tolerance		Packaging Methods		
Thick Film Chip Resistors	Type	Inch	Power R.	K	Std.	Code	Tolerance	Code	Packaging	Part No.
	L03	0603	0.2 W		20m Ω, 22m Ω, 33m Ω, 39m Ω, 47m Ω, 50m Ω, 100m Ω	F	± 1 %	V	Punched Carrier Taping 4 mm pitch, 5,000 pcs.	ERJL03 ERJL06 ERJL08
	L06	0805	0.25 W	U	20m Ω to 100m Ω*	J	± 5 %	U	Embossed Carrier Taping 4 mm pitch, 5,000 pcs.	ERJL14 ERJL12 ERJL1D
	L08	1206	0.33 W	* L03, L06, L08 : 47m Ω to 100m Ω L1D, L1W : 40m Ω to 100m Ω						
	L14	1210	0.33 W							
	L12	1812	0.5 W							
	L1D	2010	0.5 W							
	L1W	2512	1 W							

Resistance Value	
Shown by 3 digits or letters. (Ex.) 50M:50m Ω, 10 C:100m Ω	

Ratings

<High power (double-sided resistive elements structure) type>

Part No. (inch size)	Power Rating ⁽²⁾ at 70 °C (W)	Resistance Tolerance (%)	Resistance ⁽¹⁾ Range (Ω)	T.C.R. (× 10 ⁻⁶ /°C)	Category Temperature Range (°C)	AEC-Q200 Grade
ERJ2LW (0402)	0.2	±1, ±2, ±5	10m	0 to 500	-55 to +125	Grade 1
ERJ3LW (0603)	0.25	±1, ±2, ±5	5m	0 to 700	-55 to +125	Grade 1
			10m	0 to 300	-55 to +125	
ERJ6LW (0805)	0.5	±1, ±2, ±5	5, 6, 7, 8, 9m	0 to 300	-55 to +125	Grade 1
ERJ2BW (0402)	0.25	±1, ±2, ±5	47m to 100m (E24)	±300	-55 to +155	Grade 0
ERJ3BW (0603)	0.33	±1, ±2, ±5	20m to 100m (E24)	20m Ω ≤ R < 39m Ω : ±250 39m Ω ≤ R ≤ 100m Ω : ±150	-55 to +155	Grade 0
ERJ6BW (0805)	0.5	±1, ±2, ±5	10m to 100m (E24)	10m Ω ≤ R < 15m Ω : ±300 15m Ω ≤ R ≤ 100m Ω : ±200	-55 to +155	Grade 0
ERJ8BW (1206)	1	±1, ±2, ±5	10m to 100m (E24)	10m Ω ≤ R < 20m Ω : ±200 20m Ω ≤ R < 47m Ω : ±150 47m Ω ≤ R ≤ 100m Ω : ±100	-55 to +155	Grade 0
ERJ6CW (0805)	0.5	±0.5, ±1, ±2, ±5	10m to 30m (E24)	±75	-55 to +125	Grade 1
ERJ8CW (1206)	1	±1, ±2, ±5	10m to 50m (E24)	±75	-55 to +125	Grade 1

(1) Please contact us when resistors of irregular series are needed.

(2) Use it on the condition that the case temperature is below the upper category temperature.

- Rated Continuous Working Voltage (RCWV) shall be determined from RCWV = √ Power Rating × Resistance Values.
- Overload Test Voltage (OTV) shall be determined from OTV = Specified Magnification (refer to performance) × RCWV.

Ratings

<High power type>

Part No. (inch size)	Power Rating ⁽²⁾ at 70 °C (W)	Resistance Tolerance ⁽³⁾ (%)	Resistance ⁽¹⁾ Range (Ω)	T.C.R. (× 10 ⁻⁶ /°C)	Category Temperature Range (°C)	AEC-Q200 Grade
ERJ2BS (0402)	0.166	±1, ±2, ±5	0.10 to 0.20 (E24)	±300	-55 to +155	Grade 0
ERJ2BQ (0402)			0.22 to 1.0 (E24)	±250		
ERJ3BS (0603)	0.25	±1, ±2, ±5	0.10 to 0.20 (E24)	±300	-55 to +155	Grade 0
ERJ3BQ (0603)			0.22 to 0.91 (E24)			
			1.0 to 9.1 (E24)	±200		
ERJ6DS (0805)	0.5	±0.5, ±1, ±2, ±5	0.10 to 0.20 (E24, E96)	±150	-55 to +155	Grade 0
ERJ6DQ (0805)			0.22 to 9.1 (E24, E96)	±100		
ERJ6BS (0805)	0.33	±1, ±2, ±5	0.10 to 0.20 (E24)	±250	-55 to +155	Grade 0
ERJ6BQ (0805)			0.22 to 0.91 (E24)			
			1.0 to 9.1 (E24)	±200		
ERJ8BS (1206)	0.5	±1, ±2, ±5	0.10 to 0.20 (E24)	±250	-55 to +155	Grade 0
ERJ8BQ (1206)			0.22 to 0.91 (E24)			
			1.0 to 9.1 (E24)	±200		
ERJ14BS (1210)	0.5	±1, ±2, ±5	0.10 to 0.20 (E24)	±200	-55 to +155	Grade 0
ERJ14BQ (1210)			0.22 to 0.91 (E24)			
			1.0 to 9.1 (E24)	±100		

(1) Please contact us when resistors of irregular series are needed.

(2) Use it on the condition that the case temperature is below the upper category temperature.

(3) E96 series also have ±0.5 %, ±1 % line-up.

· Rated Continuous Working Voltage (RCWV) shall be determined from $RCWV = \sqrt{\text{Power Rating} \times \text{Resistance Values}}$.

· Overload Test Voltage (OTV) shall be determined from $OTV = \text{Specified Magnification (refer to performance)} \times RCWV$.

<Standard type>

Part No. (inch size)	Power Rating ⁽²⁾ at 70 °C (W)	Resistance Tolerance ⁽³⁾ (%)	Resistance ⁽¹⁾ Range (Ω)	T.C.R. (× 10 ⁻⁶ /°C)	Category Temperature Range (°C)	AEC-Q200 Grade
ERJ3RS (0603)	0.1	±1, ±2, ±5	0.10 to 0.20 (E24)	±300	-55 to +155	Grade 0
ERJ3RQ (0603)			0.22 to 0.91 (E24)			
			1.0 to 9.1 (E24)	±200		
ERJ6RS (0805)	0.125	±1, ±2, ±5	0.10 to 0.20 (E24)	±250	-55 to +155	Grade 0
ERJ6RQ (0805)			0.22 to 0.91 (E24)			
			1.0 to 9.1 (E24)	±200		
ERJ8RS (1206)	0.25	±1, ±2, ±5	0.10 to 0.20 (E24)	±250	-55 to +155	Grade 0
ERJ8RQ (1206)			0.22 to 0.91 (E24)			
			1.0 to 9.1 (E24)	±200		
ERJ14RS (1210)	0.25	±1, ±2, ±5	0.10 to 0.20 (E24)	±200	-55 to +155	Grade 0
ERJ14RQ (1210)			0.22 to 0.91 (E24)			
			1.0 to 9.1 (E24)	±100		
ERJ12RS (1812)	0.5	±1, ±2, ±5	0.10 to 0.20 (E24)	±200	-55 to +155	Grade 0
ERJ12RQ (1812)			0.22 to 0.91 (E24)			
			1.0 to 9.1 (E24)	±100		
ERJ12ZS (2010)	0.5	±1, ±2, ±5	0.10 to 0.20 (E24)	±200	-55 to +155	Grade 0
ERJ12ZQ (2010)			0.22 to 0.91 (E24)			
			1.0 to 9.1 (E24)	±100		
ERJ1TRS (2512)	1	±1, ±2, ±5	0.10 to 0.20 (E24)	±200	-55 to +155	Grade 0
ERJ1TRQ (2512)			0.22 to 0.91 (E24)			
			1.0 to 9.1 (E24)	±100		

(1) Please contact us when resistors of irregular series are needed.

(2) Use it on the condition that the case temperature is below the upper category temperature.

· Rated Continuous Working Voltage (RCWV) shall be determined from $RCWV = \sqrt{\text{Power Rating} \times \text{Resistance Values}}$.

· Overload Test Voltage (OTV) shall be determined from $OTV = \text{Specified Magnification (refer to performance)} \times RCWV$.

<Low TCR type>

Part No. (inch size)	Power Rating ⁽²⁾ at 70 °C (W)	Resistance Tolerance (%)	Resistance Range ⁽¹⁾ (Ω)	T.C.R. (×10 ⁻⁶ /°C)	Category Temperature Range (°C)	AEC-Q200 Grade
ERJL03 (0603)	0.2	±1, ±5	47m to 100m	±200	-55 to +125	Grade 1
ERJL06 (0805)	0.25	±1, ±5	47m to 100m	±100	-55 to +125	Grade 1
ERJL08 (1206)	0.33	±1, ±5	47m to 100m	±100	-55 to +125	Grade 1
ERJL14 (1210)	0.33	±1, ±5	20m to 100m	R < 47m Ω : ±300 R ≥ 47m Ω : ±100	-55 to +125	Grade 1
ERJL12 (1812)	0.5	±1, ±5	20m to 100m		-55 to +125	Grade 1
ERJL1D (2010)	0.5	±1, ±5	40m to 100m		-55 to +125	Grade 1
ERJL1W (2512)	1	±1, ±5	40m to 100m		-55 to +125	Grade 1

(1) Standard R.V. : 20m Ω, 22m Ω, 33m Ω, 39m Ω, 47m Ω, 50m Ω, 100m Ω, Custom R.V. : Each 1m Ω within upper range.
 (2) Use it on the condition that the case temperature is below the upper category temperature.

- Rated Continuous Working Voltage (RCWV) shall be determined from $RCWV = \sqrt{\text{Power Rating} \times \text{Resistance Values}}$.
- Overload Test Voltage (OTV) shall be determined from $OTV = \text{Specified Magnification (refer to performance)} \times RCWV$.

Construction

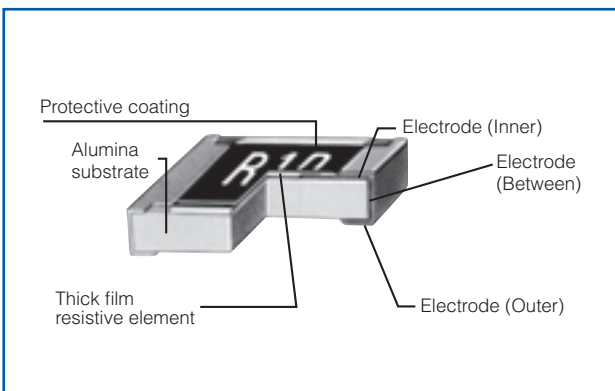

Power Derating Curve

For resistors operated in ambient temperatures above 70 °C, power rating shall be derated in accordance with the figure below.

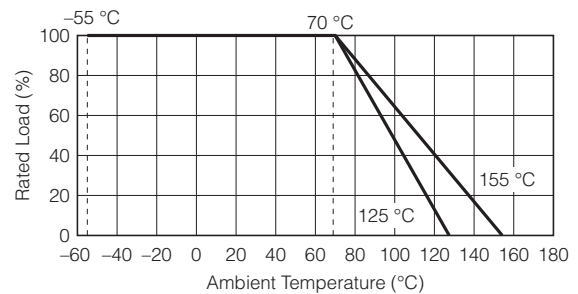

Dimensions in mm (not to scale)

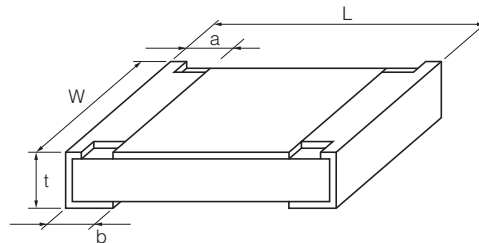

Part No.	Dimensions (mm)					Mass(Weight) [g/1000 pcs.]
	L	W	a	b	t	
ERJ2LW	1.00 ^{±0.10}	0.50 ^{+0.10/-0.05}	0.25 ^{±0.10}	0.25 ^{±0.10}	0.40 ^{±0.05}	0.8
ERJ2BW	1.00 ^{±0.10}	0.50 ^{+0.10/-0.05}	0.24 ^{±0.10}	0.24 ^{±0.10}	0.35 ^{±0.05}	0.8
ERJ2BS	1.00 ^{±0.10}	0.50 ^{+0.10/-0.05}	0.20 ^{±0.10}	0.27 ^{±0.10}	0.35 ^{±0.05}	0.8
ERJ2BQ			0.20 ^{±0.10}	0.27 ^{±0.10}	0.35 ^{±0.05}	
ERJ3LW (5m Ω)	1.60 ^{±0.15}	0.80 ^{±0.15}	0.50 ^{±0.20}	0.50 ^{±0.20}	0.55 ^{±0.10}	3
ERJ3LW (10m Ω)	1.60 ^{±0.15}	0.80 ^{±0.15}	0.40 ^{±0.20}	0.40 ^{±0.20}	0.55 ^{±0.10}	3
ERJ3BW			0.40 ^{±0.20}	0.40 ^{±0.20}	0.55 ^{±0.10}	
ERJ3R	1.60 ^{±0.15}	0.80 ^{+0.15/-0.05}	0.30 ^{±0.20}	0.30 ^{±0.15}	0.45 ^{±0.10}	2
ERJ3B			0.30 ^{±0.20}	0.30 ^{±0.15}	0.45 ^{±0.10}	
ERJL03	2.00 ^{±0.20}	1.25 ^{±0.20}	0.63 ^{±0.20}	0.63 ^{±0.20}	0.70 ^{±0.10}	6
ERJ6LW			0.63 ^{±0.20}	0.63 ^{±0.20}	0.70 ^{±0.10}	
ERJ6BW	2.00 ^{±0.20}	1.25 ^{±0.20}	0.55 ^{±0.20}	0.55 ^{±0.20}	0.65 ^{±0.10}	6
ERJ6CW (10 to 13m Ω)			0.60 ^{±0.20}	0.60 ^{±0.20}	0.65 ^{±0.10}	
ERJ6CW (15 to 30m Ω)	2.05 ^{±0.20}	1.30 ^{±0.20}	0.45 ^{±0.20}	0.45 ^{±0.20}	0.65 ^{±0.10}	6
ERJ6D			0.45 ^{±0.20}	0.45 ^{±0.20}	0.65 ^{±0.10}	
ERJ6D	2.00 ^{±0.20}	1.25 ^{±0.10}	0.40 ^{±0.20}	0.55 ^{±0.25}	0.60 ^{±0.10}	5
ERJ6R	2.00 ^{±0.20}	1.25 ^{±0.10}	0.40 ^{±0.20}	0.40 ^{±0.20}	0.60 ^{±0.10}	5
ERJ6B					0.60 ^{±0.10}	
ERJL06					0.60 ^{±0.10}	

Part No.	Dimensions (mm)					Mass(Weight) [g/1000 pcs.]
	L	W	a	b	t	
ERJ8BW	3.20 ^{±0.20}	1.60 ^{±0.20}	1.00 ^{±0.20}	1.00 ^{±0.20}	0.65 ^{±0.10}	13
ERJ8CW (10 to 16m Ω)	3.20 ^{±0.20}	1.60 ^{±0.20}	1.10 ^{±0.20}	1.10 ^{±0.20}	0.65 ^{±0.10}	13
ERJ8CW (18 to 50m Ω)			0.60 ^{±0.20}	0.60 ^{±0.20}	0.65 ^{±0.10}	
ERJ8R	3.20 ^{+0.05/-0.20}	1.60 ^{+0.05/-0.15}	0.50 ^{±0.20}	0.50 ^{±0.20}	0.60 ^{±0.10}	10
ERJ8B						
ERJL08	3.20 ^{±0.20}	2.50 ^{±0.20}	0.50 ^{±0.20}	0.50 ^{±0.20}	0.60 ^{±0.10}	16
ERJ14R						
ERJ14B	4.50 ^{±0.20}	3.20 ^{±0.20}	0.50 ^{±0.20}	0.50 ^{±0.20}	0.60 ^{±0.10}	27
ERJ12R						
ERJL12	5.00 ^{±0.20}	2.50 ^{±0.20}	0.60 ^{±0.20}	0.60 ^{±0.20}	0.60 ^{±0.10}	27
ERJ12Z			0.60 ^{±0.20}	0.60 ^{±0.20}	0.60 ^{±0.10}	
ERJL1D	6.40 ^{±0.20}	3.20 ^{±0.20}	0.65 ^{±0.20}	0.60 ^{±0.20}	0.60 ^{±0.10}	45
ERJ1TR			0.65 ^{±0.20}	0.60 ^{±0.20}	0.60 ^{±0.10}	
ERJL1W	6.40 ^{±0.20}	3.20 ^{±0.20}	0.65 ^{±0.20}	1.30 ^{±0.20}	1.10 ^{±0.10}	79

Design and specifications are each subject to change without notice. Ask factory for the current technical specifications before purchase and/or use.
 Should a safety concern arise regarding this product, please be sure to contact us immediately.

Performance

- ERJ2LW, 3LW, 6LW, 2BW, 3BW, 6BW, 8BW, 6CW, 8CW
<High power (double-sided resistive elements structure) type>

Test Item	Performance Requirements	Test Conditions
Resistance	Within Specified Tolerance	20 °C
T. C. R.	Within Specified T. C. R.	+25 °C/+125 °C
Overload	±2%	Rated Voltage × 2.0, 5 s ERJ6LW : × 1.77, 5 s ERJ8BW (R > 0.05 Ω) : × 1.77, 5 s
Resistance to Soldering Heat	±1%	270 °C, 10 s
Rapid Change of Temperature	±1% ERJ2LW : ±2%	−55 °C (30 min.) / +155 °C (ERJ*LW, ERJ*CW : +125 °C) (30 min.), 100 cycles
High Temperature Exposure	±1%	+155 °C (ERJ*LW, ERJ*CW : +125 °C), 1000 h
Damp Heat, Steady State	±1%	60 °C, 90% to 95%RH, 1000 h
Load Life in Humidity	±3%	60 °C, 90% to 95%RH, Rated Voltage, 1.5 h ON/0.5 h OFF cycle, 1000 h
Endurance at 70 °C	±3%	70 °C, Rated Voltage, 1.5 h ON/0.5 h OFF cycle, 1000 h

- ERJ2BS/2BQ, 3BS/3BQ, 6BS/6BQ, 8BS/8BQ, 14BS/14BQ, 6D, 3R, 6R, 8R, 14R, 12R, 12Z, 1TR
<High power type/Standard type>

Test Item	Performance Requirements	Test Conditions
Resistance	Within Specified Tolerance	20 °C
T. C. R.	Within Specified T. C. R.	+25 °C/+125 °C
Overload	±2%	Rated Voltage × 2.5 (ERJ6D : × 1.77), 5 s
Resistance to Soldering Heat	±1%	270 °C, 10 s
Rapid Change of Temperature	±1%	−55 °C (30 min.) / +155 °C (30 min.), 100 cycles
High Temperature Exposure	±1%	+155 °C, 1000 h
Damp Heat, Steady State	±1%	60 °C, 90% to 95%RH, 1000 h
Load Life in Humidity	±3%	60 °C, 90% to 95%RH, Rated Voltage, 1.5 h ON/0.5 h OFF cycle, 1000 h
Endurance at 70 °C	±3%	70 °C, Rated Voltage, 1.5 h ON/0.5 h OFF cycle, 1000 h

- ERJL03, L06, L08, L14, L12, L1D, L1W <Low TCR type>

Test Item	Performance Requirements	Test Conditions
Resistance	Within Specified Tolerance	20 °C
T. C. R.	Within Specified T. C. R.	+25 °C/+125 °C
Overload	±2%	Rated Voltage × 2.5, 5 s
Resistance to Soldering Heat	±1%	270 °C, 10 s
Rapid Change of Temperature	±1%	−55 °C (30 min.) / +125 °C (30 min.), 100 cycles
High Temperature Exposure	±1%	+125 °C, 1000 h
Damp Heat, Steady State	±1%	60 °C, 90% to 95%RH, 1000 h
Load Life in Humidity	±3%	60 °C, 90% to 95%RH, Rated Voltage, 1.5 h ON/0.5 h OFF cycle, 1000 h
Endurance at 70 °C	±3%	70 °C, Rated Voltage, 1.5 h ON/0.5 h OFF cycle, 1000 h

Current Sensing Resistors, Metal Plate Type

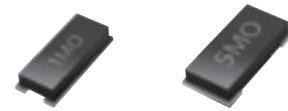

Type: ERJ MS4, MB1

Features

- Ideal for current sensing solution
- Small case size with high power
- Metal plate bonding technology. Excellent long term stability
- Outer Resin with high heat dissipation. Wide temperature range (-65 °C to +170 °C)
- AEC-Q200 qualified
- RoHS compliant
- ISO9001, ISO/TS16949 certified

As for Packaging Methods, Soldering Conditions and Safety Precautions,

Please see Data Files

Explanation of Part Numbers

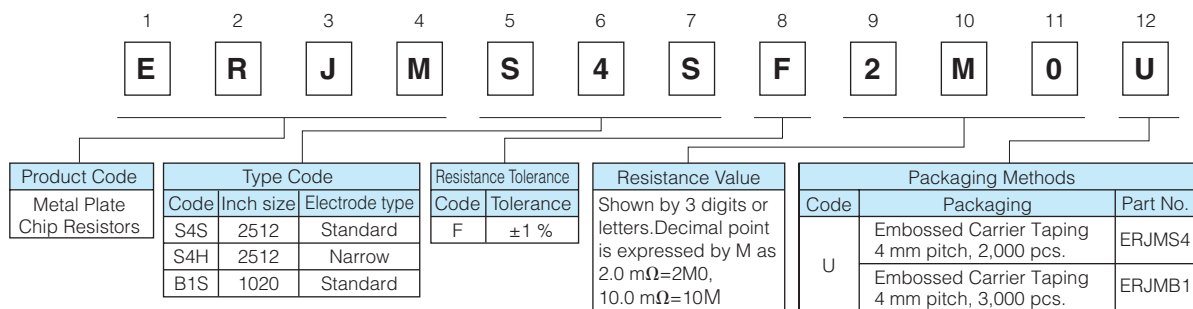

Ratings

Part No. (inch size)	Power Rating at 70 °C (W)	Resistance Range (mΩ)	Resistance Tolerance (%)	T.C.R. (×10 ⁻⁶ /°C)	Category Temperature Range (°C)	Terminal temp. upper limit (°C)
ERJMS4S (2512)	3	1, 2, 3, 4	F : ±1	±75	-65 to +170	130
ERJMS4H (2512)	3	5, 6	F : ±1	±75	-65 to +170	130
	2	7, 8, 9, 10	F : ±1	±75	-65 to +170	100
ERJMB1S (1020)	2	1, 2, 3, 4, 5	F : ±1	±75	-65 to +170	130

* Please contact us when resistors of irregular series are needed.

Power Derating Curve

If the terminal temperature of the resistor is more than terminal temperature upper limit value of the rated table, please reduce the rated power according to the Power Derating Curve shown in the figure on the right.

<Supplemented>

In the case of the temperature measurement of the terminal portion of the resistor, Please perform under the following conditions.

- 1) Terminal temperature measurement, please apply the temperature of the higher of either the left or right electrode upper surface of the resistor.
- 2) Please measure the temperature of the resistor in the land pattern printed of circuit board and plan to use by real conditions.

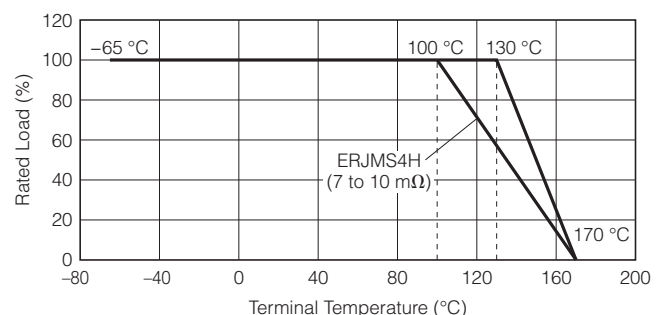

Panasonic Current Sensing Resistors, Metal Plate Type

Construction

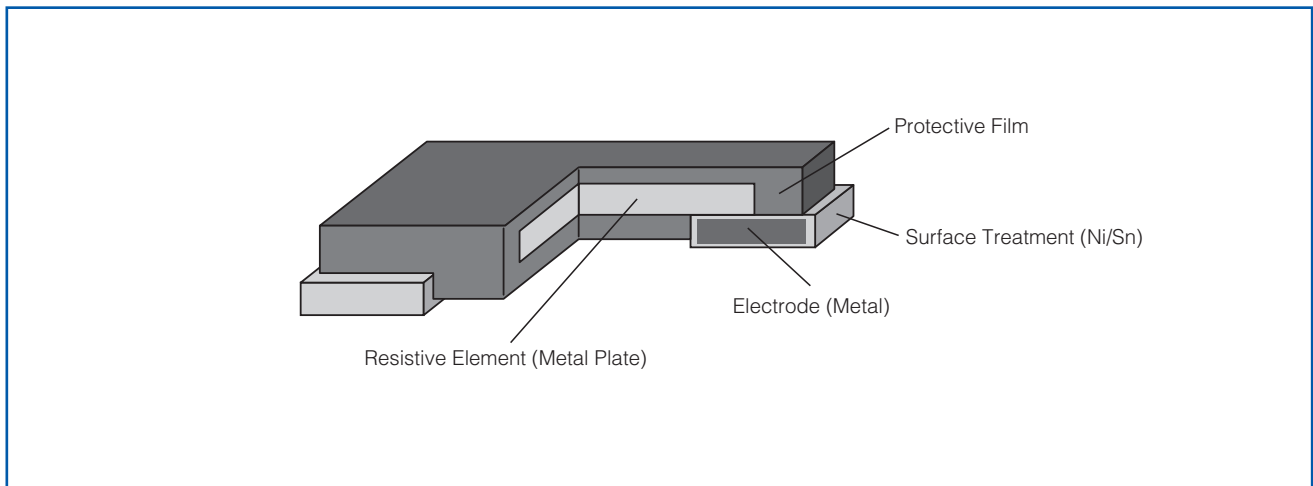

Dimensions in mm (not to scale), Recommended Land Pattern

● ERJMS4S/ERJMS4H

● ERJMB1S

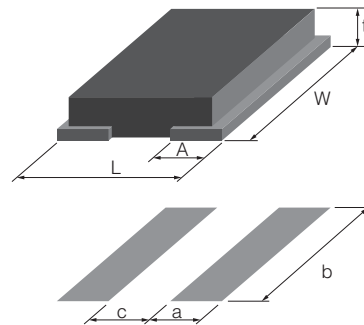
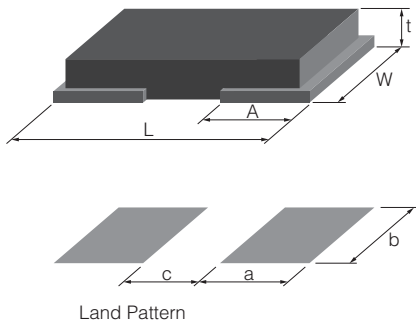

Part No. (inch size)	Dimension (mm)				Recommended Land Pattern (mm)			Mass (Weight) (g/1000 pcs.)
	L	W	A	t	a	b	c	
ERJMS4S (2512)	6.40±0.25	3.20±0.25	2.20±0.25	1.20±0.15	2.7	3.4	2.0	120
ERJMS4H (2512)	6.40±0.25	3.20±0.25	1.25±0.25	1.20±0.15	1.7	3.4	4.0	115
ERJMB1S (1020)	2.55±0.25	5.00±0.25	0.68 ^{+0.15} _{-0.20}	0.90±0.15	1.15	5.5	1.1	40

Typical Temperature dependence of electrical resistance

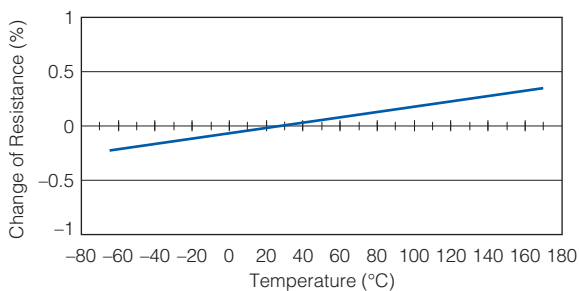

Long-term stability

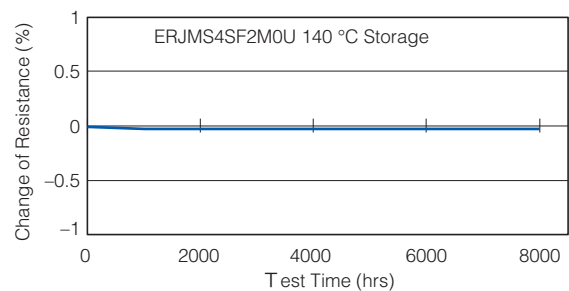

Maximum pulse energy respectively pulse power for continuous operation

Reference Data
 Condition : Room Temperature, OFF : 10 s, 1000 cycle, Wave form : Square
 Change of Resistance = $\pm 1\%$

● ERJMS4 Series

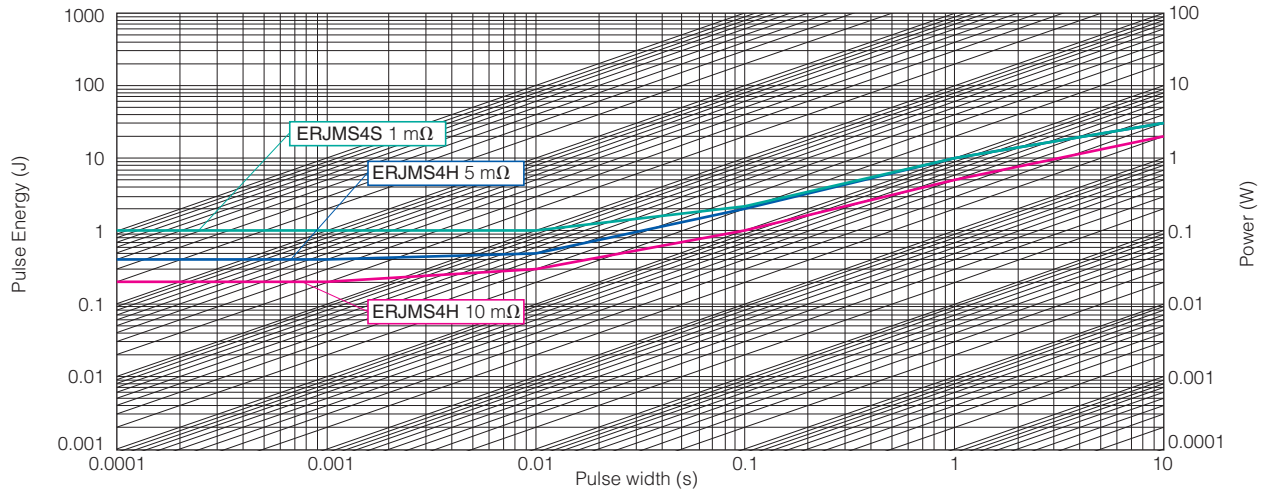

● ERJMB1 Series

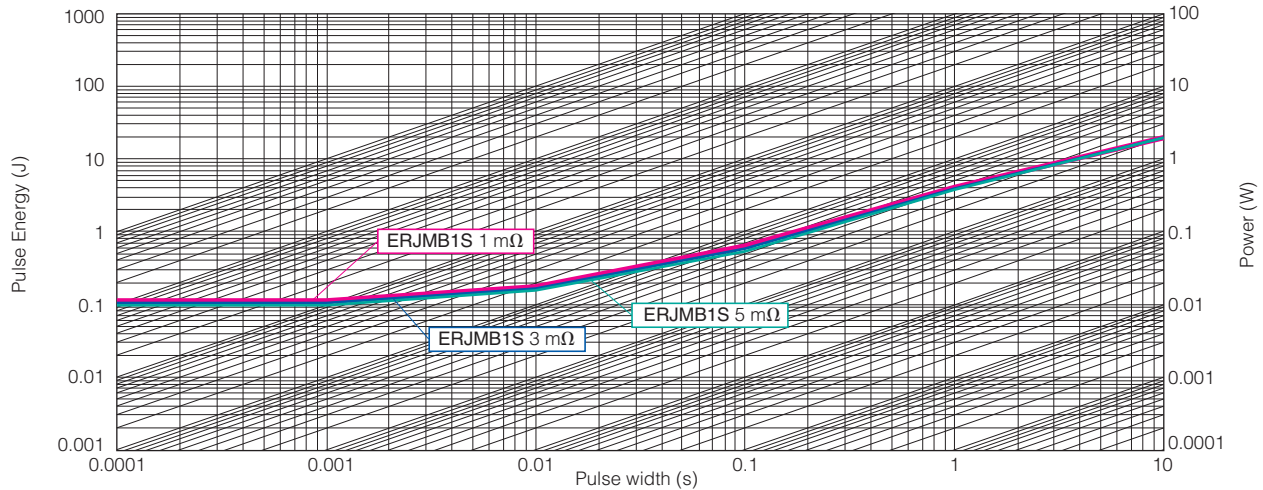

Performance (AEC-Q200)

● ERJMS4 Series

Test Item	Performance Requirements	Typical value	Test Condition
Thermal Shock	±1 %	0.20 %	-55 °C/+155 °C, 1000 cycles
Overload	±0.5 %	0.10 %	3 × Rated Power, 5 s
Solderability	> 95% coverage	> 95% coverage	245 °C, 3 s
Resistance to Solvents	No damage	No damage	MIL-STD-202 method 215, 2.1a, 2.1d
Low Temperature Storage and Operation	±0.5 %	0.03 %	-65 °C, 24 h
Resistance to Soldering Heat	±0.5 %	0.10 %	MIL-STD-202 method 210 (260 °C, 10 s)
Moisture Resistance	±0.5 %	0.10 %	MIL-STD-202 method 106
Shock	±0.5 %	0.10 %	MIL-STD-202 method 213-A
Vibration, High Frequency	±0.5 %	0.05 %	10 to 2000 (Hz)
Life	±1 %	0.30 %	70 °C, Rated Power, 2000 h
Storage Life at Elevated Temperature	±1 %	0.30 %	170 °C, 2000 h
High Temperature Characteristics	±0.5 %	0.05 %	140 °C, 2000 h
Frequency Characteristics	< 5 nH	< 2 nH	Inductance

● ERJMB1 Series

Test Item	Performance Requirements	Typical value	Test Condition
Thermal Shock	±1 %	0.30 %	-55 °C/+155 °C, 1000 cycles
Overload	±1 %	0.30 %	2.5 × Rated Power, 5 s
Solderability	> 95% coverage	> 95% coverage	245 °C, 3 s
Resistance to Solvents	No damage	No damage	MIL-STD-202 method 215, 2.1a, 2.1d
Low Temperature Storage and Operation	±0.5 %	0.03 %	-65 °C, 24 h
Resistance to Soldering Heat	±0.5 %	0.10 %	MIL-STD-202 method 210 (260 °C, 10 s)
Moisture Resistance	±0.5 %	0.10 %	MIL-STD-202 method 106
Shock	±0.5 %	0.10 %	MIL-STD-202 method 213-A
Vibration, High Frequency	±0.5 %	0.05 %	10 to 2000 (Hz)
Life	±1 %	0.30 %	70 °C, Rated Power, 2000 h
Storage Life at Elevated Temperature	±1 %	0.30 %	170 °C, 2000 h
High Temperature Characteristics	±0.5 %	0.05 %	140 °C, 2000 h
Frequency Characteristics	< 5 nH	< 2 nH	Inductance

Temperature Rise

● ERJMS4HF5M0U

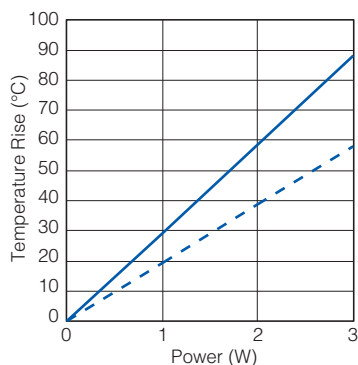

● ERJMB1SF3M0U

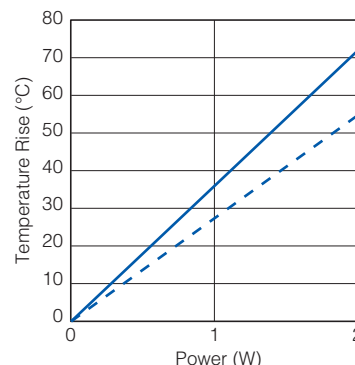

① ———
② - - - -

<Condition>
Base material : FR-4 (t1.6mm)
Copper Thickness : 70 μm, Two layer

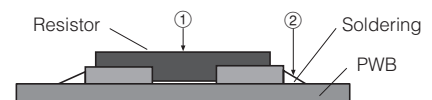

Sense terminal-Layout

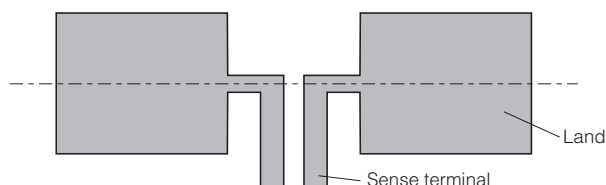

High Power Chip Resistors / Wide Terminal Type



Type: **ERJ A1, B1, B2, B3**

Features

- High solder-joint reliability by wide terminal construction
- Excellent heat dissipation characteristics by wide terminal construction
- AEC-Q200 qualified
- RoHS compliant

Recommended Applications

- Automotive electronic circuits including ECUs (Electrical control unit), anti-lock braking systems and air-bag systems
- Current sensing for power supply circuits in a variety of equipment

■ **As for Packaging Methods, Land Pattern, Soldering Conditions and Safety Precautions,**
Please see Data Files

Explanation of Part Numbers



Ratings

Part No. (inch size)	Power Rating ⁽³⁾ at 70 °C (W)	Limiting Element Voltage ⁽¹⁾ (V)	Maximum Overload Voltage ⁽²⁾ (V)	Resistance Tolerance (%)	Resistance Range (Ω)	T.C.R. ($\times 10^{-6}/^{\circ}\text{C}$)	Category Temperature Range (°C)	AEC-Q200 Grade
ERJA1 (1225)	1.33	200	400	±1	100m to 10k (E24)	±100	-55 to +155	Grade 0
				±2, ±5	10m to 10k (E24)	R < 100m Ω : ±350 100m Ω ≤ R : ±200		
ERJB1 (1020)	1 2(R ≤ 10 Ω)	200	400	±1	10m to 10k (E24)	R < 22m Ω : ±350 22m Ω ≤ R < 47m Ω : ±200 47m Ω ≤ R < 100m Ω : ±150 100m Ω ≤ R : ±100	-55 to +155	Grade 0
				±2, ±5	10m to 10k (E24)	R < 22m Ω : ±350 22m Ω ≤ R : ±200		
ERJB2 (0612)	0.75 1(R ≤ 10 Ω)	200	400	±1	10m to 1M (E24)	R < 22m Ω : 0 to +300 22m Ω ≤ R < 47m Ω : 0 to +200 47m Ω ≤ R < 100m Ω : 0 to +150 100m Ω ≤ R < 220m Ω : 0 to +100 220m Ω ≤ R : ±100	-55 to +155	Grade 0
				±2	10m to 1M (E24)	R < 22m Ω : 0 to +300 22m Ω ≤ R < 47m Ω : 0 to +200 47m Ω ≤ R < 100m Ω : 0 to +150 100m Ω ≤ R < 220m Ω : 0 to +200 220m Ω ≤ R : ±200		
				±5	5m, 6m, 7m, 8m, 9m, 10m to 1M (E24)	R < 22m Ω : 0 to +300 22m Ω ≤ R < 47m Ω : 0 to +200 47m Ω ≤ R < 100m Ω : 0 to +150 100m Ω ≤ R < 220m Ω : 0 to +200 220m Ω ≤ R : ±200		
ERJB3 (0508)	0.33 0.5(R ≤ 1 Ω)	150	200	±1	20m to 10 (E24)	R < 47m Ω : 0 to +300 47m Ω ≤ R < 1 Ω : 0 to +200 1 Ω ≤ R : ±100	-55 to +155	Grade 0
				±2, ±5	20m to 10 (E24)	R < 47m Ω : 0 to +300 47m Ω ≤ R < 1 Ω : 0 to +200 1 Ω ≤ R : ±200		

- (1) Rated Continuous Working Voltage (RCWV) shall be determined from $\text{RCWV} = \sqrt{\text{Power Rating} \times \text{Resistance Values}}$, or Limiting Element Voltage listed above, whichever less.
 (2) Overload Test Voltage (OTV) shall be determined from $\text{OTV} = \text{Specified Magnification (refer to performance)} \times \text{RCWV}$ or Maximum Overload Voltage listed above, whichever less.
 (3) Use it on the condition that the case temperature is below the upper category temperature.

Construction (Example : ERJA1 type)

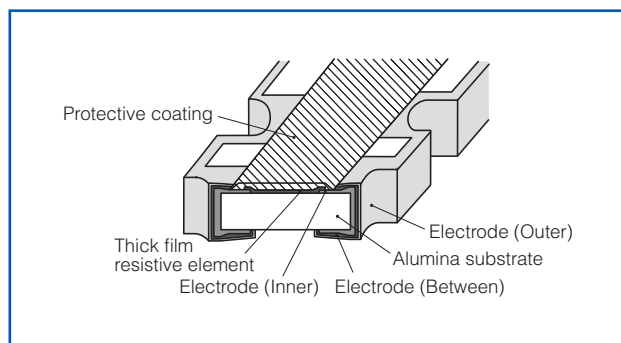

Power Derating Curve

For resistors operated in ambient temperatures above 70 °C, power rating shall be derated in accordance with the figure below.

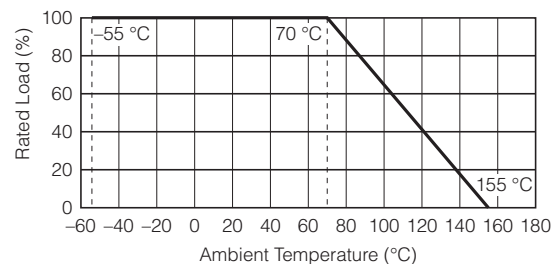

Dimensions in mm (not to scale)

ERJA1 type

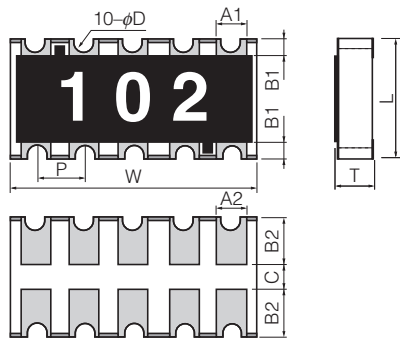

Mass (Weight) [1000 pcs.] : 40 g

Dimensions (mm)	L	W	T	A ₁	B ₁
	3.20±0.20	6.40±0.20	0.55±0.10	0.70±0.20	0.45±0.20
Dimensions (mm)	A ₂	B ₂	P	φD	C
	0.70±0.20	1.25±0.15	1.27±0.10	0.30 ^{+0.10} _{-0.20}	0.4 min.

ERJB2 type

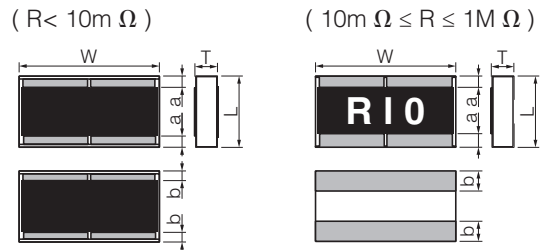

Mass (Weight) [1000 pcs.] : 11 g

Dimensions (mm)	L	W	T	a	b
5m Ω ≤ R < 10m Ω	1.60±0.15	3.20±0.20	0.65±0.15	0.30±0.20	0.30±0.20
10m Ω ≤ R < 220m Ω			0.55±0.15		
220m Ω ≤ R ≤ 1M Ω			0.25±0.20		

ERJB1 type

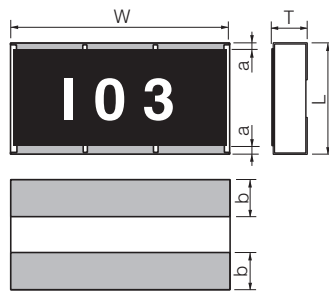

Mass (Weight) [1000 pcs.] : 27 g

Dimensions (mm)	L	W	T	a	b
	2.50±0.20	5.00±0.20	0.55±0.20	0.25±0.20	0.90±0.20

ERJB3 type

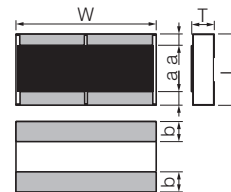

Mass (Weight) [1000 pcs.] : 4.8 g

Dimensions (mm)	L	W	T	a	b
	1.25±0.10	2.00±0.15	0.50±0.10	0.25±0.20	0.40±0.20

Circuit Configuration

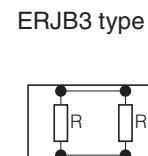
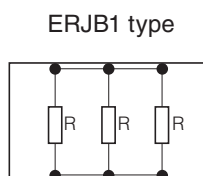
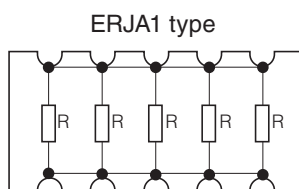

< Less than 10m Ω >

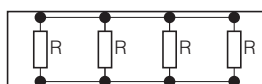

< Low resistance zone >

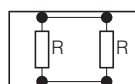

< High resistance zone >

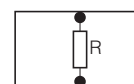

Performance		
Test Item	Performance Requirements	Test Conditions
Resistance	Within Specified Tolerance	20 °C
T. C. R.	Within Specified T. C. R.	+25 °C/+125 °C
Overload	±2%	ERJA1, ERJB1 (R > 10), ERJB3 (R > 1) : Rated Voltage × 2.5, 5 s ERJB2 (R > 10) : Rated Voltage × 2.2, 5 s ERJB1 (R ≤ 10), ERJB2 (R ≤ 10), ERJB3 (R ≤ 1) : Rated Voltage × 2.0, 5 s
Resistance to Soldering Heat	±1%	270 °C, 10 s
Rapid Change of Temperature	±2%	−55 °C (30min.) / +125 °C (30min.), 1000 cycles
High Temperature Exposure	±1%	+155 °C, 1000 h
Damp Heat, Steady State	±1%	60 °C, 90% to 95 %RH, 1000 h
Load Life in Humidity	±3%	60 °C, 90% to 95 %RH, Rated Voltage, 1.5 h ON/0.5 h OFF cycle, 1000 h
Endurance at 70 °C	±3%	70 °C, Rated Voltage, 1.5 h ON/0.5 h OFF cycle, 1000 h

Low TCR High Power Chip Resistors / Wide Terminal Type



Type: **ERJ D1, D2**

Features

- Achieved High power and low TCR ($\pm 100 \times 10^{-6}/^{\circ}\text{C}$) using wide terminal electrode structure and original material
- Suitable for small size/high power current detection (Low TCR enables high accuracy of current detection)
- High solder-joint reliability by wide terminal construction
- Excellent heat dissipation characteristics by wide terminal construction
- AEC-Q200 qualified
- RoHS compliant

Recommended Applications

- Automotive electronic circuits including ECUs (Electrical control unit), anti-lock braking systems and air-bag systems
- Current sensing for power supply circuits in a variety of equipment

■ **As for Packaging Methods, Land Pattern, Soldering Conditions and Safety Precautions,**
Please see Data Files

Explanation of Part Numbers

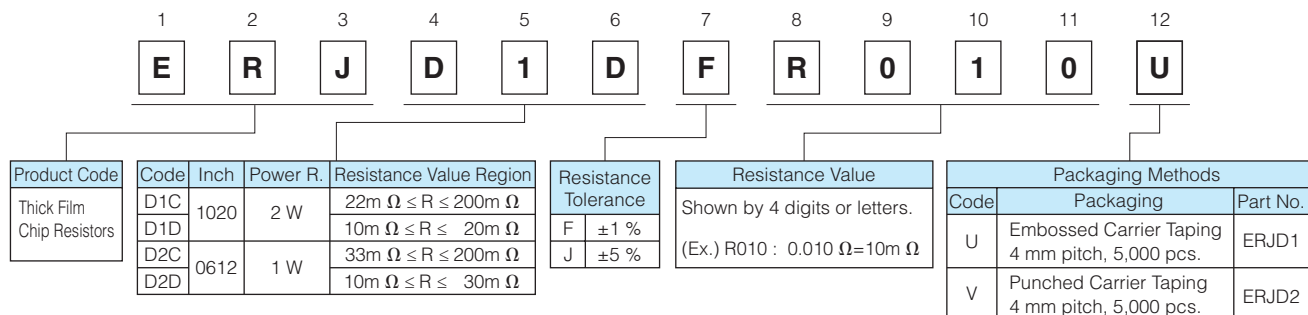

Ratings

Part No. (inch size)	Power Rating ⁽²⁾ at 70 °C (W)	Resistance Tolerance (%)	Resistance Range ⁽¹⁾ (Ω)	T.C.R. ($\times 10^{-6}/^{\circ}\text{C}$)	Category Temperature Range (°C)	AEC-Q200 Grade
ERJD1 (1020)	2	±1, ±5	10m to 200m (E24)	±100	-55 to +155	Grade 0
ERJD2 (0612)	1	±1, ±5	10m to 200m (E24)	±100		

(1) Please contact us when resistors of irregular series are needed.

(2) Use it on the condition that the case temperature is below the upper category temperature.

- Rated Continuous Working Voltage (RCWV) shall be determined from $\text{RCWV} = \sqrt{\text{Power Rating} \times \text{Resistance Values}}$.
- Overload Test Voltage (OTV) shall be determined from $\text{OTV} = \text{Specified Magnification (refer to performance)} \times \text{RCWV}$.

Construction

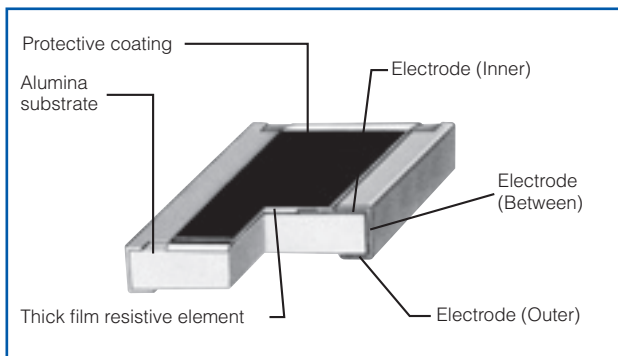

Power Derating Curve

For resistors operated in ambient temperatures above 70 °C, power rating shall be derated in accordance with the figure below.

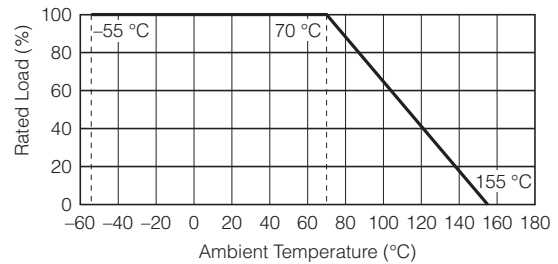

Dimensions in mm (not to scale)

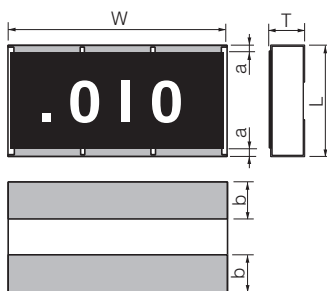

Mass (Weight) [1000 pcs.] : 27 g

Part No.	Dimensions (mm)				
	L	W	T	a	b
ERJD1	2.50±0.20	5.00±0.20	0.60±0.20	0.30±0.20	0.90±0.20

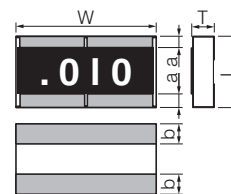

Mass (Weight) [1000 pcs.] : 11 g

Part No.	Dimensions (mm)				
	L	W	T	a	b
ERJD2	1.60±0.15	3.20±0.20	0.65±0.15	0.30±0.20	0.50±0.20

Circuit Configuration

ERJD1 type

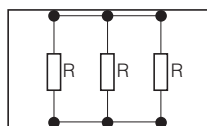

ERJD2 type

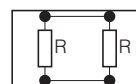

Performance

Test Item	Performance Requirements	Test Conditions
Resistance	Within Specified Tolerance	20 °C
T. C. R.	Within Specified T. C. R.	+25 °C/+125 °C
Overload	±2%	Rated Voltage × 2.0, 5 s
Resistance to Soldering Heat	±1%	270 °C, 10 s
Rapid Change of Temperature	±2%	-55 °C (30min.) / +125 °C (30min.), 1000 cycles
High Temperature Exposure	±1%	+155 °C, 1000 h
Damp Heat, Steady State	±1%	60 °C, 90% to 95%RH, 1000 h
Load Life in Humidity	±3%	60 °C, 90% to 95 %RH, Rated Voltage, 1.5 h ON/0.5 h OFF cycle, 1000 h
Endurance at 70 °C	±3%	70 °C, Rated Voltage, 1.5 h ON/0.5 h OFF cycle, 1000 h

Anti-Surge Thick Film Chip Resistors

Type: **ERJ PA2, P03, PA3, P06, P08, P14**



Features

- ESD surge characteristics superior to standard metal film resistors
- High reliability
Metal glaze thick film resistive element and three layers of electrodes
- Suitable for both reflow and flow soldering
- High power ... 0.20 W : 0402 inch / 1005 mm size (ERJPA2), 0603 inch / 1608 mm size (ERJP03)
0.25 W : 0603 inch / 1608 mm size (ERJPA3)
0.50 W : 0805 inch / 2012 mm size (ERJP06), 1210 inch / 3225 mm size (ERJP14)
0.66 W : 1206 inch / 3216 mm size (ERJP08)
- Reference Standards... IEC 60115-8, JIS C 5201-8, JEITA RC-2134C
- AEC-Q200 qualified
- RoHS compliant

■ **As for Packaging Methods, Land Pattern, Soldering Conditions and Safety Precautions,**
Please see Data Files

Explanation of Part Numbers

	1	2	3	4	5	6	7	8	9	10	11	12
	E	R	J	P	0	6	D	1	0	0	2	V

Product Code	Size, Power Rating		Resistance Tolerance		Resistance Value	Packaging Methods			
Thick Film Chip Resistors	Code	Inch	Power R.	Code		Tolerance	Code	Packaging	Part No.
	PA2	0402	0.20 W	D	± 0.5 %	The first two or three digits are significant figures of resistance and the third or 4th one denotes number of zeros following. Three digit type (±5 %), four digit type (±1 %, ±0.5 %) Example: 222→2.2 kΩ, 1002→10 kΩ	X	Punched Carrier Taping 2 mm pitch, 10,000 pcs.	ERJPA2
	P03	0603	0.20 W	F	± 1 %		V	Punched Carrier Taping 4 mm pitch, 5,000 pcs.	ERJP03 ERJPA3 ERJP06 ERJP08
	PA3	0603	0.25 W	J	± 5 %		U	Embossed Carrier Taping 4 mm pitch, 5,000 pcs.	ERJP14
	P06	0805	0.50 W						
	P08	1206	0.66 W						
	P14	1210	0.50 W						

Construction

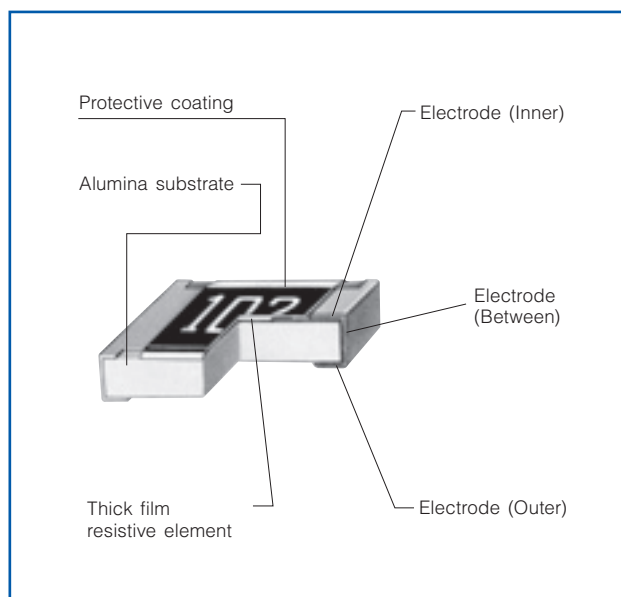

Dimensions in mm (not to scale)

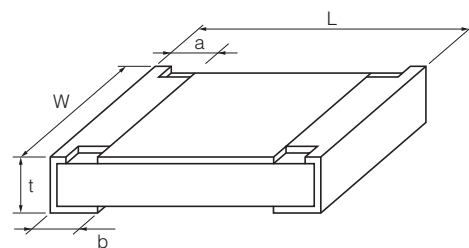

Part No.	Dimensions (mm)					Mass (Weight) [g/1000 pcs.]
	L	W	a	b	t	
ERJPA2	1.00 ^{+0.05}	0.50 ^{+0.05}	0.20 ^{+0.15}	0.25 ^{+0.05}	0.35 ^{+0.05}	0.8
ERJP03	1.60 ^{+0.15}	0.80 ^{+0.15} _{-0.05}	0.15 ^{+0.15} _{-0.10}	0.30 ^{+0.15}	0.45 ^{+0.10}	2
ERJPA3	1.60 ^{+0.15}	0.80 ^{+0.15} _{-0.05}	0.15 ^{+0.15} _{-0.10}	0.25 ^{+0.10}	0.45 ^{+0.10}	2
ERJP06	2.00 ^{+0.20}	1.25 ^{+0.10}	0.25 ^{+0.20}	0.40 ^{+0.20}	0.60 ^{+0.10}	4
ERJP08	3.20 ^{+0.05} _{-0.20}	1.60 ^{+0.05} _{-0.15}	0.40 ^{+0.20}	0.50 ^{+0.20}	0.60 ^{+0.10}	10
ERJP14	3.20 ^{+0.20}	2.50 ^{+0.20}	0.35 ^{+0.20}	0.50 ^{+0.20}	0.60 ^{+0.10}	16

Ratings

Part No. (inch size)	Power Rating ⁽³⁾ at 70 °C (W)	Limiting Element Voltage ⁽¹⁾ (V)	Maximum Overload Voltage ⁽²⁾ (V)	Resistance Tolerance (%)	Resistance Range (Ω)	T.C.R. ($\times 10^{-6}/^{\circ}\text{C}$)	Category Temperature Range (°C)	AEC-Q200 Grade
ERJPA2 (0402)	0.20	50	100	$\pm 0.5, \pm 1$	10 to 1M (E24, E96)	± 100	-55 to +155	Grade 0
				± 5	10 to 1M (E24)	± 200		
ERJP03 (0603)	0.20	150	200	± 0.5	10 to 1M (E24, E96)	± 150	-55 to +155	Grade 0
				± 1	10 to 1M (E24, E96)	± 200		
				± 5	1 to 1M (E24)	± 200 <small>R < 10 Ω : -150 to +400 10 Ω ≤ R : ±200</small>		
ERJPA3 (0603)	0.25 (105 °C)	150	200	$\pm 0.5, \pm 1$	10 to 1M (E24, E96)	± 100	-55 to +155	Grade 0
				± 5	1 to 1.5M (E24)	± 200		
ERJP06 (0805)	0.50	400	600	$\pm 0.5, \pm 1$	10 to 1M (E24, E96)	± 100 <small>R < 33 Ω : ±300 33 Ω ≤ R : ±100</small>	-55 to +155	Grade 0
				± 5	1 to 3.3M (E24)	± 200 <small>R < 10 Ω : -100 to +600 10 Ω ≤ R < 33 Ω : ±300 33 Ω ≤ R : ±200</small>		
ERJP08 (1206)	0.66	500	1000	$\pm 0.5, \pm 1$	10 to 1M (E24, E96)	± 100	-55 to +155	Grade 0
				± 5	1 to 10M (E24)	± 200 <small>R < 10 Ω : -100 to +600 10 Ω ≤ R : ±200</small>		
ERJP14 (1210)	0.50	200	400	$\pm 0.5, \pm 1$	10 to 1M (E24, E96)	± 100	-55 to +155	Grade 0
				± 5	1 to 1M (E24)	± 200 <small>R < 10 Ω : -100 to +600 10 Ω ≤ R : ±200</small>		

- (1) Rated Continuous Working Voltage (RCWV) shall be determined from $\text{RCWV} = \sqrt{\text{Power Rating} \times \text{Resistance Values}}$, or Limiting Element Voltage listed above, whichever less.
 (2) Overload Test Voltage (OTV) shall be determined from $\text{OTV} = \text{Specified Magnification (refer to performance)} \times \text{RCWV}$ or Maximum Overload Voltage listed above, whichever less.
 (3) Use it on the condition that the case temperature is below the upper category temperature.

Power Derating Curve

For resistors operated in rated temperatures above 70 °C or 105 °C, power rating shall be derated in accordance with the figure on the right.

* When the temperature of ERJP14 is 155 °C or less, the derating start temperature can be changed to 125 °C. (See the dotted line)

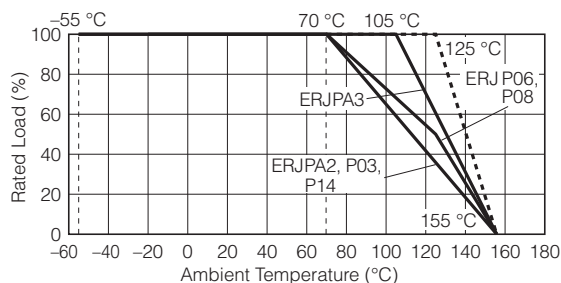

ESD Characteristic

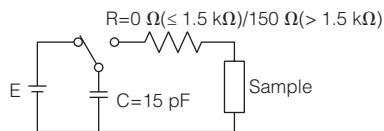

0402 inch size : E=±1 kV
 0603, 0805, 1206, 1210 inch size : E=±3 kV

— Anti-Surge Thick Film Chip Resistors(ERJP Series)
 - - - Thick Film Chip Resistors(ERJ Series)

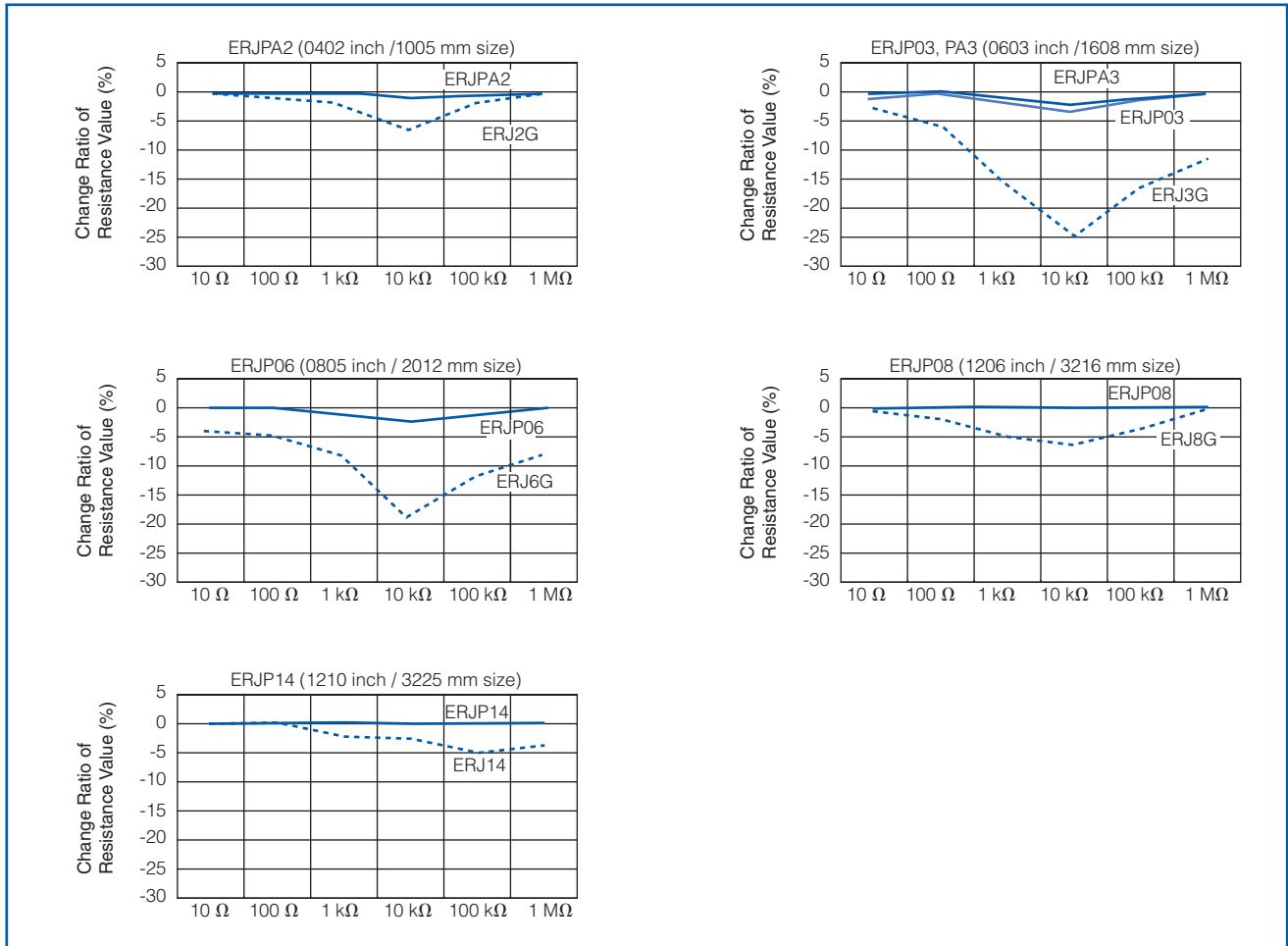

Performance

Test Item	Performance Requirements	Test Conditions
Resistance	Within Specified Tolerance	20 °C
T. C. R.	Within Specified T. C. R.	+25 °C/+155 °C (ERJPA2 : +125 °C)
Overload	±2 % Only when it is ERJP03 (D), P14 (D) : ±0.5 %	ERJP06 : Rated Voltage×1.77, 5 s ERJPA2, ERJPA3, ERJP08 : Rated Voltage×2.0, 5 s ERJP03, ERJP14 : Rated Voltage×2.5, 5 s
Resistance to Soldering Heat	D : ±0.5 %, F, J : ±1 %	270 °C, 10 s
Rapid Change of Temperature	±1 %	-55 °C (30min.) / +155 °C (30min.) , 100 cycles
High Temperature Exposure	±1 %	+155 °C, 1000 h
Damp Heat, Steady State	±1 %	60 °C, 90 % to 95 %RH, 1000 h
Load Life in Humidity	±3 % Only when it is ERJP03 (D), P14 (D) : ±1 %	60 °C, 90 % to 95 %RH, Rated Voltage, 1.5 h ON / 0.5 h OFF cycle, 1000 h
Endurance at 70 °C (ERJPA3 : 105 °C)	±3 % Only when it is ERJP03 (D), P14 (D) : ±1 %	70 °C (ERJPA3 : 105 °C), Rated Voltage, 1.5 h ON / 0.5 h OFF cycle, 1000 h

Design and specifications are each subject to change without notice. Ask factory for the current technical specifications before purchase and/or use.
 Should a safety concern arise regarding this product, please be sure to contact us immediately.

Anti-Pulse Thick Film Chip Resistors



Type: **ERJ T06, T08, T14**
ERJ T14L

Features

- Anti-Pulse characteristics
High pulse characteristics achieved by the optimized trimming specifications (ERJT06, T08, T14)
- Further high pulse characteristics achieved by trimming-less specifications (ERJT14L)
- High reliability
Metal glaze thick film resistive element and three layers of electrodes
- Suitable for both reflow and flow soldering
- High power ... 0.25W : 0805 inch / 2012 mm size (ERJT06)
0.33W : 1206 inch / 3216 mm size (ERJT08)
0.50W : 1210 inch / 3225 mm size (ERJT14, ERJT14L)
- Reference Standards...IEC 60115-8, JIS C 5201-8, JEITA RC-2134C
- AEC-Q200 qualified
- RoHS compliant

■ **As for Packaging Methods, Land Pattern, Soldering Conditions and Safety Precautions,**
Please see Data Files

Explanation of Part Numbers

- ERJT06, T08, T14 Series

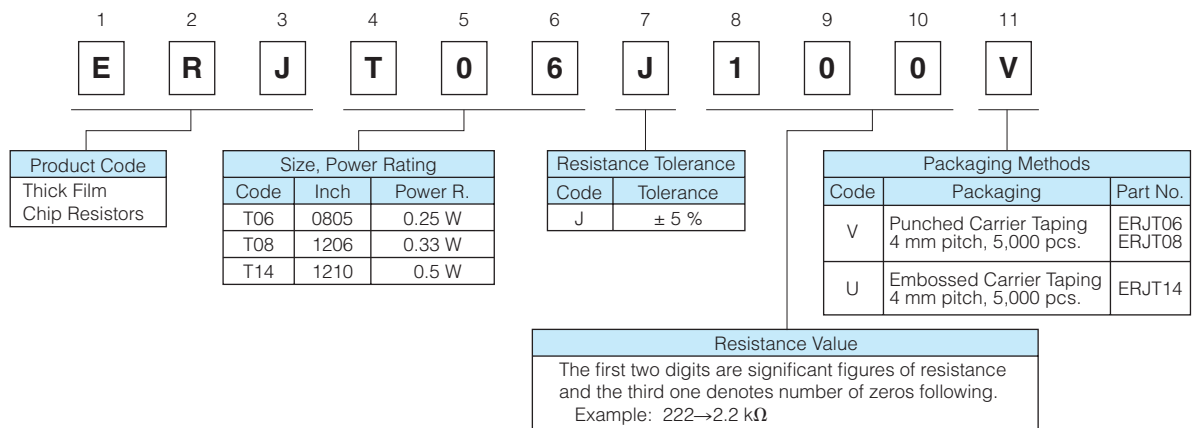

- ERJT14L Series

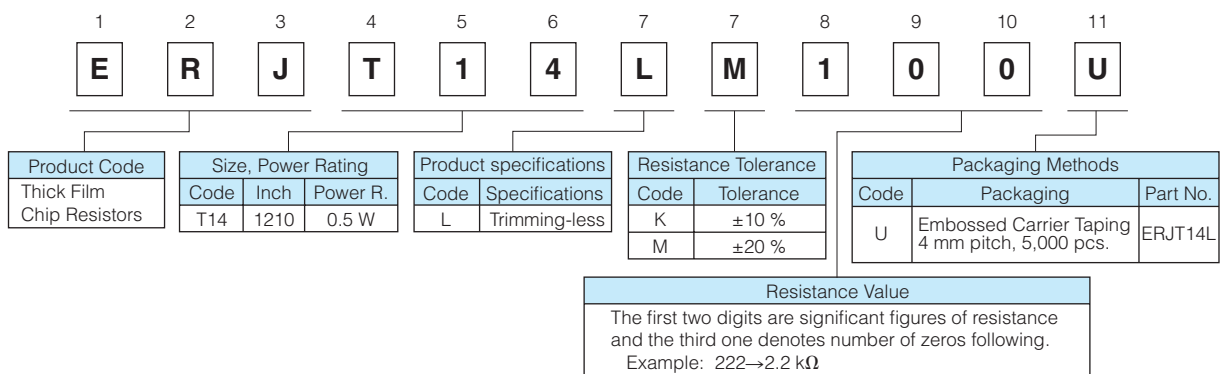

* Please contact us for 2012 (mm) and 3216 (mm) size trimming-less types.

Construction

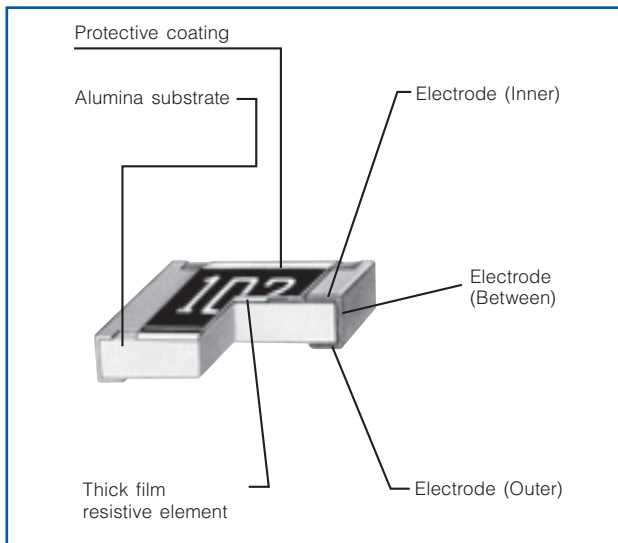

Dimensions in mm (not to scale)

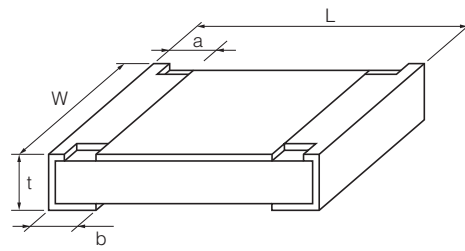

Part No.	Dimensions (mm)					Mass (Weight) [g/1000 pcs.]
	L	W	a	b	t	
ERJT06	2.00 ^{+0.20}	1.25 ^{+0.10}	0.25 ^{+0.20}	0.40 ^{+0.20}	0.60 ^{+0.10}	4
ERJT08	3.20 ^{+0.05} _{-0.20}	1.60 ^{+0.05} _{-0.15}	0.40 ^{+0.20}	0.50 ^{+0.20}	0.60 ^{+0.10}	10
ERJT14 ERJT14L	3.20 ^{+0.20}	2.50 ^{+0.20}	0.35 ^{+0.20}	0.50 ^{+0.20}	0.60 ^{+0.10}	16

Ratings

Part No. (inch size)	Power Rating ⁽³⁾ at 70 °C (W)	Limiting Element Voltage ⁽¹⁾ (V)	Maximum Overload Voltage ⁽²⁾ (V)	Resistance Tolerance (%)	Resistance Range (Ω)	T.C.R. (×10 ⁻⁶ /°C)	Category Temperature Range (°C)	AEC-Q200 Grade
ERJT06 (0805)	0.25	150	200	±5	1 to 1M (E24)	R < 10 Ω : -100 to +600 10 Ω ≤ R < 33 Ω : ±300 33 Ω ≤ R : ±200	-55 to +155	Grade 0
ERJT08 (1206)	0.33	200	400	±5	1 to 1M (E24)	R < 10 Ω : -100 to +600 10 Ω ≤ R : ±200	-55 to +155	Grade 0
ERJT14 (1210)	0.50	200	400	±5	1 to 1M (E24)	R < 10 Ω : -100 to +600 10 Ω ≤ R : ±200	-55 to +155	Grade 0
ERJT14L (1210)	0.50	200	400	±10 ±20	1 to 1M (E12)	R < 10 Ω : -100 to +600 10 Ω ≤ R : ±200	-55 to +155	Grade 0

- (1) Rated Continuous Working Voltage (RCWV) shall be determined from $RCWV = \sqrt{\text{Power Rating} \times \text{Resistance Values}}$, or Limiting Element Voltage listed above, whichever less.
 (2) Overload Test Voltage (OTV) shall be determined from $OTV = \text{Specified Magnification (refer to performance)} \times RCWV$ or Maximum Overload Voltage listed above, whichever less.
 (3) Use it on the condition that the case temperature is below the upper category temperature.

Power Derating Curve

For resistors operated in ambient temperatures above 70 °C, power rating shall be derated in accordance with the figure on the right.

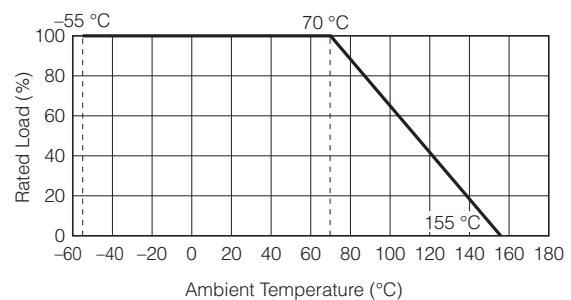

Limiting Power Curve

- Inrush pulse Characteristic

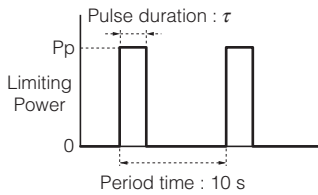

Test cycle : 1000 cycles
Spec : Resistance value = within $\pm 5\%$

- ▲ : Anti-Pulse Thick Film Chip Resistors (ERJT14L Series)
- : Anti-Pulse Thick Film Chip Resistors (ERJT Series)
- : Thick Film Chip Resistors (ERJ Series : 1 Ω)

- ERJT06 (0805 inch/2012 mm size)

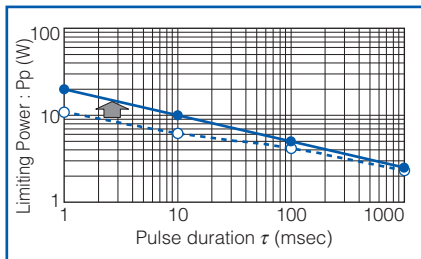

- ERJT08 (1206 inch/3216 mm size)

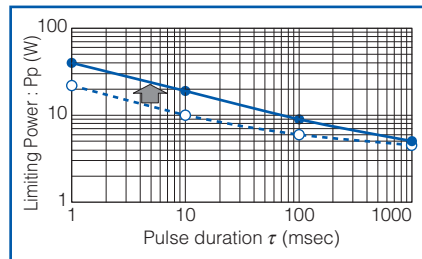

- ERJT14,ERJT14L (1210 inch/3225 mm size)

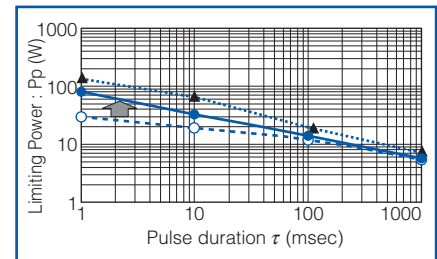

* Please contact us for 2012 (mm) and 3216 (mm) size trimming-less types.

Performance

Test Item	Performance Requirements	Test Conditions
Resistance	Within Specified Tolerance	20 °C
T. C. R.	Within Specified T. C. R.	+25 °C/+155 °C
Overload	$\pm 2\%$	Rated Voltage \times 2.5, 5 s
Resistance to Soldering Heat	$\pm 1\%$	270 °C \pm 3 °C, 10 s \pm 1 s
Rapid Change of Temperature	$\pm 1\%$	-55 °C (30min.) / +155 °C (30min.), 100 cycles
High Temperature Exposure	$\pm 1\%$	+155 °C, 1000 h
Damp Heat, Steady State	$\pm 1\%$	60 °C \pm 2 °C, 90 % to 95 %RH, 1000 h
Load Life in Humidity	$\pm 3\%$	60 °C \pm 2 °C, 90 % to 95 %RH, Rated Voltage, 1.5 h ON / 0.5 h OFF cycle, 1000 h
Endurance at 70 °C	$\pm 3\%$	70 °C \pm 2 °C, Rated Voltage, 1.5 h ON / 0.5 h OFF cycle, 1000 h

Anti-Sulfurated Thick Film Chip Resistors



Type: **ERJ S02, S03, S06, S08, S14, S12, S1D, S1T**
(Au-based inner electrode type)

Type: **ERJ U01, U02, U03, U06, U08, U14, U12, U1D, U1T, U6S, U6Q**
(Ag-Pd-based inner electrode type)

Features

- High resistance to sulfurization achieved by adopting an Au-based inner electrode (ERJS Series) and Ag-Pd-based inner electrode (ERJU Series)
- High reliability
Metal glaze thick film resistive element and three layers of electrodes
- Suitable for both reflow and flow soldering
- Low Resistance type ... ERJU6S, U6Q : 0.1 Ω to 1.0 Ω
- Reference Standard ... IEC 60115-8, JIS C 5201-8, JEITA RC-2134C
- AEC-Q200 qualified (Exemption ERJU01)
- RoHS compliant

■ **As for Packaging Methods, Land Pattern, Soldering Conditions and Safety Precautions,**
Please see Data Files

Explanation of Part Numbers

- ERJU01 to ERJU1T, ERJS02 to ERJS1T Series

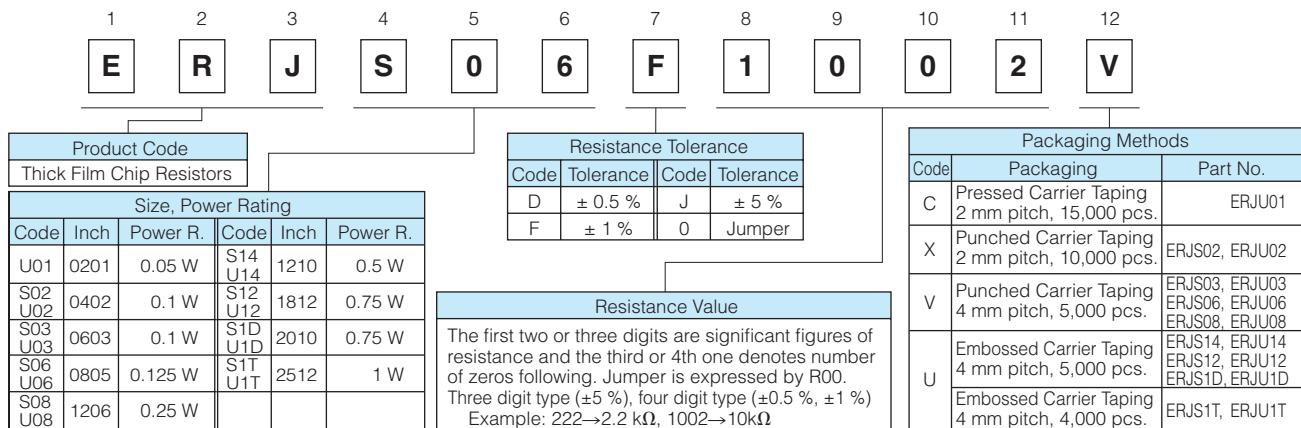

- ERJU6S, U6Q Series

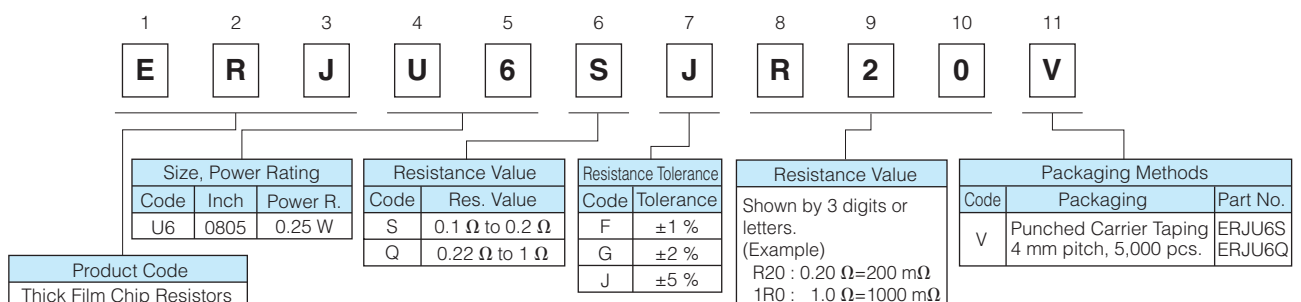

Construction

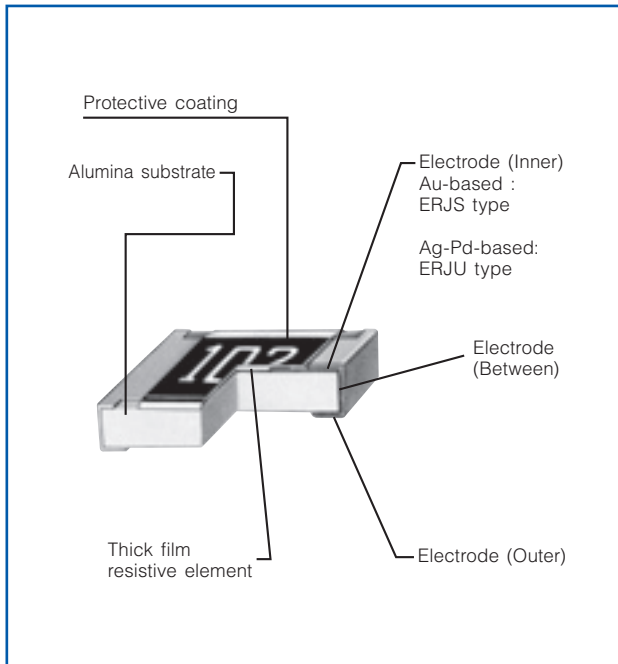

Dimensions in mm (not to scale)

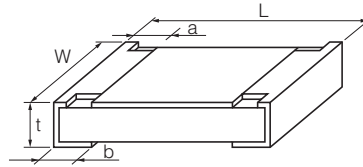

Part No.	Dimensions (mm)					Mass (Weight) [g/1000 pcs.]
	L	W	a	b	t	
ERJU01	0.60 ^{+0.03}	0.30 ^{+0.03}	0.10 ^{+0.05}	0.15 ^{+0.05}	0.23 ^{+0.03}	0.15
ERJS02 ERJU02	1.00 ^{+0.05}	0.50 ^{+0.05}	0.20 ^{+0.10}	0.25 ^{+0.10}	0.35 ^{+0.05}	0.8
ERJS03 ERJU03	1.60 ^{+0.15}	0.80 ^{+0.15}	0.30 ^{+0.20}	0.30 ^{+0.15}	0.45 ^{+0.10}	2
ERJS06 ERJU06	2.00 ^{+0.20}	1.25 ^{+0.10}	0.40 ^{+0.20}	0.40 ^{+0.20}	0.60 ^{+0.10}	4
ERJU6□	2.00 ^{+0.20}	1.25 ^{+0.10}	0.45 ^{+0.20}	0.45 ^{+0.20}	0.55 ^{+0.10}	6
ERJS08 ERJU08	3.20 ^{+0.05}	1.60 ^{+0.15}	0.50 ^{+0.20}	0.50 ^{+0.20}	0.60 ^{+0.10}	10
ERJS14 ERJU14	3.20 ^{+0.20}	2.50 ^{+0.20}	0.50 ^{+0.20}	0.50 ^{+0.20}	0.60 ^{+0.10}	16
ERJS12 ERJU12	4.50 ^{+0.20}	3.20 ^{+0.20}	0.50 ^{+0.20}	0.50 ^{+0.20}	0.60 ^{+0.10}	27
ERJS1D ERJU1D	5.00 ^{+0.20}	2.50 ^{+0.20}	0.60 ^{+0.20}	0.60 ^{+0.20}	0.60 ^{+0.10}	27
ERJS1T ERJU1T	6.40 ^{+0.20}	3.20 ^{+0.20}	0.65 ^{+0.20}	0.60 ^{+0.20}	0.60 ^{+0.10}	45

Ratings

Part No. (inch size)	Power Rating ⁽³⁾ at 70 °C (W)	Limiting Element Voltage ⁽¹⁾ (V)	Maximum Overload Voltage ⁽²⁾ (V)	Resistance Tolerance (%)	Resistance Range (Ω)	T.C.R. (×10 ⁻⁶ /°C)	Category Temperature Range (°C)	AEC-Q200 Grade
ERJU01 (0201)	0.05	25	50	±1	10 to 1M (E24, E96)	<10 Ω: -100 to +600 10 Ω to 1 MΩ: ±200(±5 %) ±100(±0.5, ±1 %)* *ERJU01, ERJS02, ERJU02 : ±200	-55 to +125	-
ERJS02 ERJU02 (0402)	0.1	50	100	±0.5, ±1	1 to 1M (E24, E96)		-55 to +155	Grade 0
ERJS03 ERJU03 (0603)	0.1	75	150	±0.5, ±1	1 to 3.3M (E24)		-55 to +155	Grade 0
ERJS06 ERJU06 (0805)	0.125	150	200	±0.5, ±1	1 to 1M (E24, E96)		-55 to +155	Grade 0
ERJS08 ERJU08 (1206)	0.25	200	400	±0.5, ±1	1 to 10M (E24)		-55 to +155	Grade 0
ERJS14 ERJU14 (1210)	0.5	200	400	±0.5, ±1	1 to 1M (E24, E96)		-55 to +155	Grade 0
ERJS12 ERJU12 (1812)	0.75	200	500	±0.5, ±1	1 to 10M (E24)		-55 to +155	Grade 0
ERJS1D ERJU1D (2010)	0.75	200	500	±0.5, ±1	1 to 1M (E24, E96)		-55 to +155	Grade 0
ERJS1T ERJU1T (2512)	1.0	200	500	±0.5, ±1	1 to 10M (E24)		-55 to +155	Grade 0
				±5	1 to 10M (E24)		1 MΩ<: -400 to +150	-55 to +155

- (1) Rated Continuous Working Voltage (RCWV) shall be determined from $RCWV = \sqrt{\text{Power Rating} \times \text{Resistance Values}}$, or Limiting Element Voltage listed above, whichever less.
 (2) Overload Test Voltage (OTV) shall be determined from $OTV = \text{Specified Magnification (refer to performance)} \times RCWV$ or Maximum Overload Voltage listed above, whichever less.
 (3) Use it on the condition that the case temperature is below the upper category temperature.

[Low Resistance type]

Part No. (inch size)	Power Rating ⁽¹⁾ at 70 °C (W)	Resistance Tolerance (%)	Resistance Range (Ω)	T.C.R. (×10 ⁻⁶ /°C)	Category Temperature Range (°C)	AEC-Q200 Grade
ERJU6S (0805)	0.25	±1, ±2, ±5	0.1 to 0.2 (E24)	±150	-55 to +155	Grade 0
ERJU6Q (0805)			0.22 to 1 (E24)			

- (1) Use it on the condition that the case temperature is below the upper category temperature.
 · Rated Continuous Working Voltage (RCWV) shall be determined from $RCWV = \sqrt{\text{Power Rating} \times \text{Resistance Values}}$.
 · Overload Test Voltage (OTV) shall be determined from $OTV = \text{Specified Magnification (refer to performance)} \times RCWV$.

[For Jumper]

Part No. (inch size)	Rated Current (A)	Maximum Overload Current ⁽¹⁾ (A)
ERJU01 (0201)	0.5	1
ERJS02 ERJU02 (0402)	1	2
ERJS03 ERJU03 (0603)		
ERJS06 ERJU06 (0805)	2	4
ERJS08 ERJU08 (1206)		
ERJS14 ERJU14 (1210)		
ERJS12 ERJU12 (1812)		
ERJS1D ERJU1D (2012)		
ERJS1T ERJU1T (2512)		

(1) Overload test current

Power Derating Curve

For resistors operated in ambient temperatures above 70 °C, power rating shall be derated in accordance with the figure below.

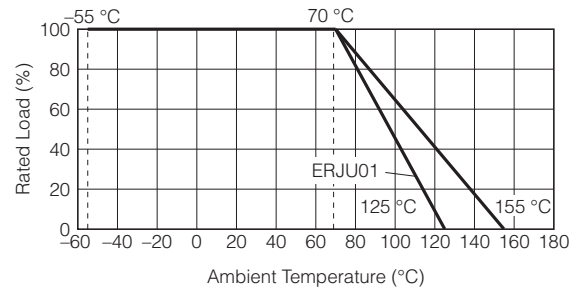

Performance

● ERJU01 to ERJU1T, ERJS02 to ERJS1T Series

Test Item	Performance Requirements		Test Conditions
	Resistor type	Jumper type	
Resistance	Within Specified Tolerance	100 mΩ or less	20 °C
T. C. R.	Within Specified T. C. R.	200 mΩ or less	+25 °C/+155 °C (ERJU01 : +25 °C/+125 °C)
Overload	±2 %	100 mΩ or less	Rated Voltage × 2.5, 5 s Jumper type : Max. Overload Current, 5 s
Resistance to Soldering Heat	±1 %	100 mΩ or less	270 °C, 10 s
Rapid Change of Temperature	±1 %	100 mΩ or less	-55 °C (30min.) / +155 °C (ERJU01: +125 °C) (30min.), 100 cycles
High Temperature Exposure	±1 %	100 mΩ or less	+155 °C (ERJU01 : +125 °C), 1000 h
Damp Heat, Steady State	±1 %	100 mΩ or less	60 °C, 90 % to 95 %RH, 1000 h
Load Life in Humidity	±3 %	100 mΩ or less	60 °C, 90 % to 95 %RH, Rated Voltage (Jumper type : Rated Current), 1.5 h ON/0.5 h OFF cycle, 1000 h
Endurance at 70 °C	±3 %	100 mΩ or less	70 °C, Rated Voltage (Jumper type : Rated Current), 1.5 h ON/0.5 h OFF cycle, 1000 h

● ERJU6S, U6Q Series

Test Item	Performance Requirements	Test Conditions
Resistance	Within Specified Tolerance	20 °C
T. C. R.	Within Specified T. C. R.	+25 °C/+125 °C
Overload	±1 %	Rated Voltage × 2.5, 5 s
Resistance to Soldering Heat	±1 %	270 °C, 10 s
Rapid Change of Temperature	±1 %	-55 °C (30min.) / +125 °C (30min.), 100 cycles
High Temperature Exposure	±1 %	+155 °C, 1000 h
Damp Heat, Steady State	±1 %	60 °C, 90 % to 95 %RH, 1000 h
Load Life in Humidity	±3 %	60 °C, 90 % to 95 %RH, Rated Voltage, 1.5 h ON/0.5 h OFF cycle, 1000 h
Endurance at 70 °C	±3 %	70 °C, Rated Voltage, 1.5 h ON/0.5 h OFF cycle, 1000 h

Design and specifications are each subject to change without notice. Ask factory for the current technical specifications before purchase and/or use. Should a safety concern arise regarding this product, please be sure to contact us immediately.

Anti-Sulfurated Thick Film Chip Resistors / Anti-Surge Type



Type: **ERJ UP3, UP6, UP8**

Features

- High resistance to sulfurization achieved by adopting Anti-Sulfurated electrode structure and material
- ESD surge characteristics superior to standard metal film resistors
- High reliability
Metal glaze thick film resistive element and three layers of electrodes
- Suitable for both reflow and flow soldering
- High power ... 0.25 W : 0603 inch / 1608 mm size (ERJUP3)
0.50 W : 0805 inch / 2012 mm size (ERJUP6)
0.66 W : 1206 inch / 3216 mm size (ERJUP8)
- Reference Standards... IEC 60115-8, JIS C 5201-8, EIAJ RC-2134B
- AEC-Q200 qualified
- RoHS compliant

■ **As for Packaging Methods, Land Pattern, Soldering Conditions and Safety Precautions,**
Please see Data Files

Explanation of Part Numbers

1	2	3	4	5	6	7	8	9	10	11	12
E	R	J	U	P	6	D	1	0	0	2	V

Product Code	Size, Power Rating		Resistance Tolerance		Resistance Value	Packaging Methods			
Thick Film Chip Resistors	Code	Inch	Power R.	Code		Code	Packaging	Part No.	
	▲UP3	0603	0.25 W	D		The first two or three digits are significant figures of resistance and the third or 4th one denotes number of zeros following. Three digit type ($\pm 5\%$), four digit type ($\pm 1\%$, $\pm 0.5\%$) Example: 222→2.2k Ω , 1002→10k Ω	V	Punched Carrier Taping 4 mm pitch, 5,000 pcs.	▲ERJUP3 ERJUP6 ERJUP8
	UP6	0805	0.50 W	F			$\pm 1\%$		
	UP8	1206	0.66 W	J	$\pm 5\%$				
	▲Under development								

Construction

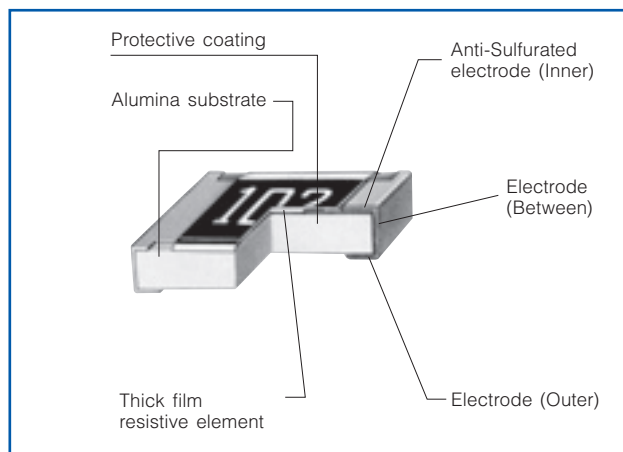

Dimensions in mm (not to scale)

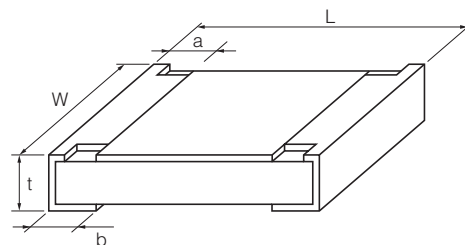

Part No.	Dimensions (mm)					Mass (Weight) [g/1000 pcs.]
	L	W	a	b	t	
▲ERJUP3	1.60 ^{+0.15}	0.80 ^{+0.15} _{-0.05}	0.15 ^{+0.15} _{-0.10}	0.25 ^{+0.10}	0.45 ^{+0.10}	2
ERJUP6	2.00 ^{+0.20}	1.25 ^{+0.10}	0.25 ^{+0.20}	0.40 ^{+0.20}	0.60 ^{+0.10}	4
ERJUP8	3.20 ^{+0.05} _{-0.20}	1.60 ^{+0.05} _{-0.15}	0.40 ^{+0.20}	0.50 ^{+0.20}	0.60 ^{+0.10}	10

Ratings

Part No. (inch size)	Power Rating ⁽³⁾ at 70 °C (W)	Limiting Element Voltage ⁽¹⁾ (V)	Maximum Overload Voltage ⁽²⁾ (V)	Resistance Tolerance (%)	Resistance Range (Ω)	T.C.R. ($\times 10^{-6}/^{\circ}\text{C}$)	Category Temperature Range (°C)	AEC-Q200 Grade
▲ERJUP3 (0603)	0.25	150	200	$\pm 0.5, \pm 1$	10 to 1M (E24, E96)	± 100	-55 to +155	Grade 0
				± 5	1 to 1.5M (E24)	± 200		
ERJUP6 (0805)	0.50	400	600	$\pm 0.5, \pm 1$	10 to 1M (E24, E96)	± 100	-55 to +155	Grade 0
				± 5	1 to 3.3M (E24)	$R < 10 \Omega : -100 \text{ to } +600$ $10 \Omega \leq R : \pm 200$		
ERJUP8 (1206)	0.66	500	1000	$\pm 0.5, \pm 1$	10 to 1M (E24, E96)	± 100	-55 to +155	Grade 0
				± 5	1 to 10M (E24)	$R < 10 \Omega : -100 \text{ to } +600$ $10 \Omega \leq R : \pm 200$		

- (1) Rated Continuous Working Voltage (RCWV) shall be determined from $\text{RCWV} = \sqrt{\text{Power Rating} \times \text{Resistance Value}}$, or Limiting Element Voltage listed above, whichever less.
 (2) Overload Test Voltage (OTV) shall be determined from $\text{OTV} = \text{Specified Magnification (refer to performance)} \times \text{RCWV}$ or Maximum Overload Voltage listed above, whichever less.
 (3) Use it on the condition that the case temperature is below the upper category temperature.

Power Derating Curve

For resistors operated in ambient temperatures above 70 °C, power rating shall be derated in accordance with the figure on the right.

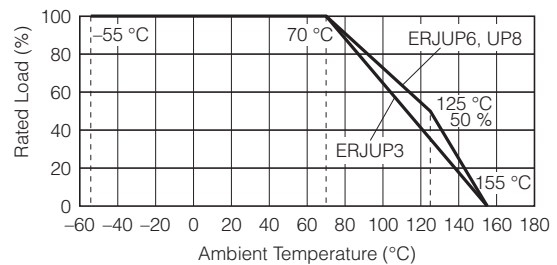

ESD Characteristic

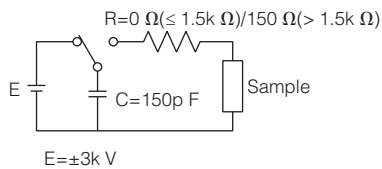

- Anti-Sulfurated Thick Film Chip Resistors / Anti-Surge Type (ERJUP Type)
- - - Anti-Sulfurated Thick Film Chip Resistors (ERJU Type)

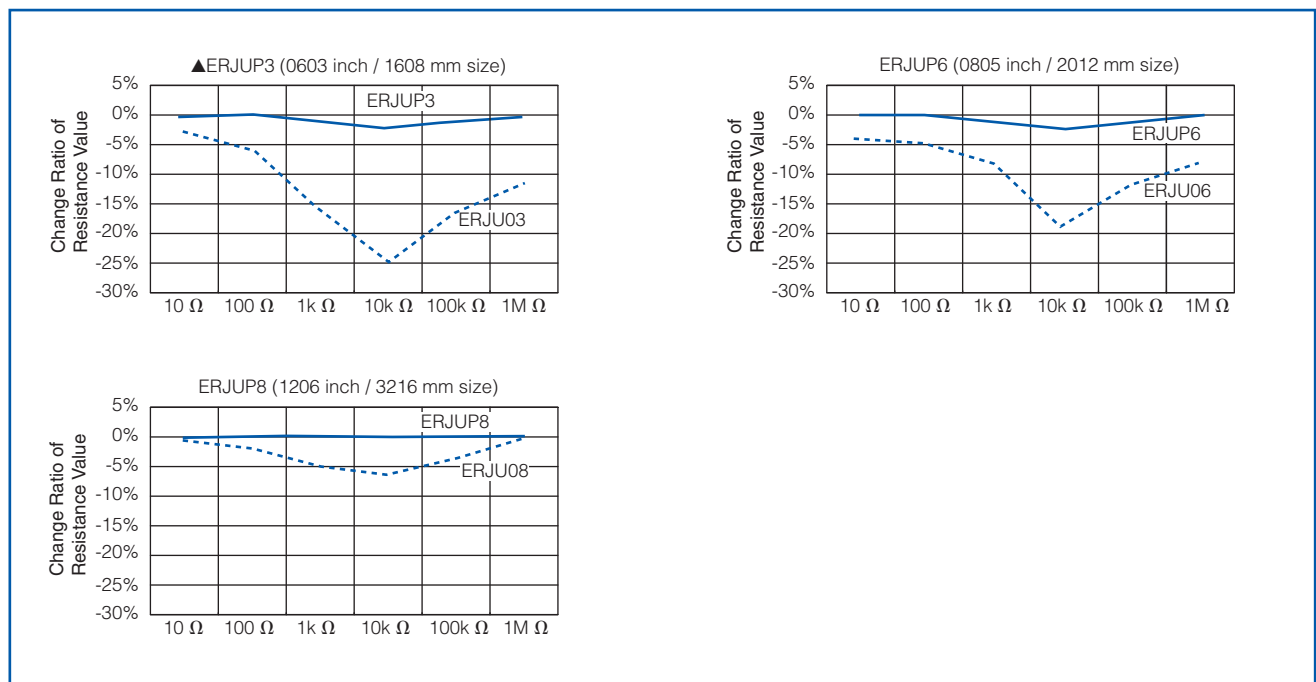

Performance		
Test Item	Performance Requirements	Test Conditions
Resistance	Within Specified Tolerance	20 °C
T. C. R.	Within Specified T. C. R.	+25 °C/+155 °C
Overload	±2%	ERJUP6 : Rated Voltage × 1.77, 5 s ▲ERJUP3, ERJUP8 : Rated Voltage × 2.0, 5 s
Resistance to Soldering Heat	D : ±0.5% F, J : ±1%	270 °C, 10 s
Rapid Change of Temperature	±1%	-55 °C (30 min.) / +155 °C (30 min.), 100 cycles
High Temperature Exposure	±1%	+155 °C, 1000 h
Damp Heat, Steady State	±1%	60 °C, 90% to 95%RH, 1000 h
Load Life in Humidity	±3%	60 °C, 90% to 95%RH, Rated Voltage, 1.5 h ON / 0.5 h OFF cycle, 1000 h
Endurance at 70 °C	±3%	70 °C, Rated Voltage, 1.5 h ON / 0.5 h OFF cycle, 1000 h

Anti-Sulfurated High Power Chip Resistors / Wide Terminal Type



Type: **ERJ C1**

Features

- High resistance to sulfurization achieved by adopting Anti-Sulfurated electrode structure and material
- High solder-joint reliability by wide terminal construction
- Excellent heat dissipation characteristics by wide terminal construction
- AEC-Q200 qualified
- RoHS compliant

Recommended Applications

- Motor control circuit of the industrial equipment
- Automotive electronic circuits including ECUs (Electrical control unit), anti-lock braking systems and air-bag systems
- Current sensing for power supply circuits in a variety of equipment

■ **As for Packaging Methods, Land Pattern, Soldering Conditions and Safety Precautions,**
Please see Data Files

Explanation of Part Numbers

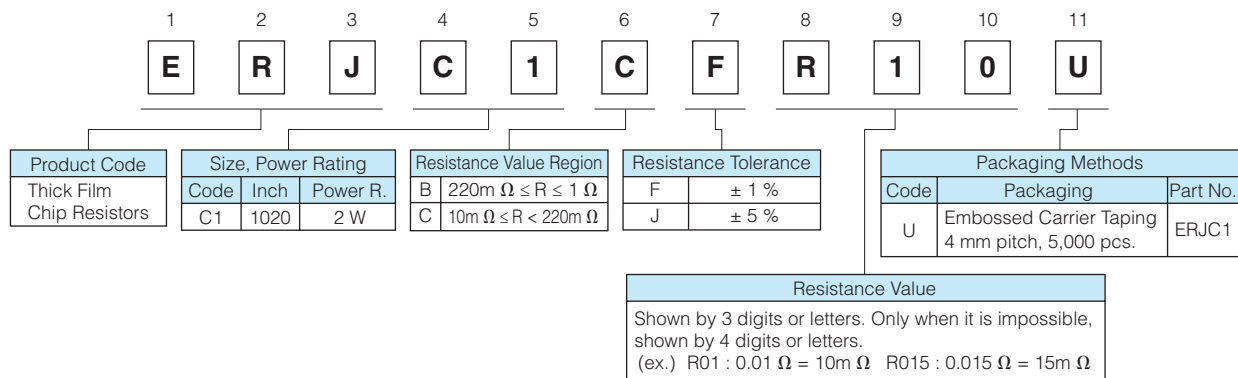

Construction

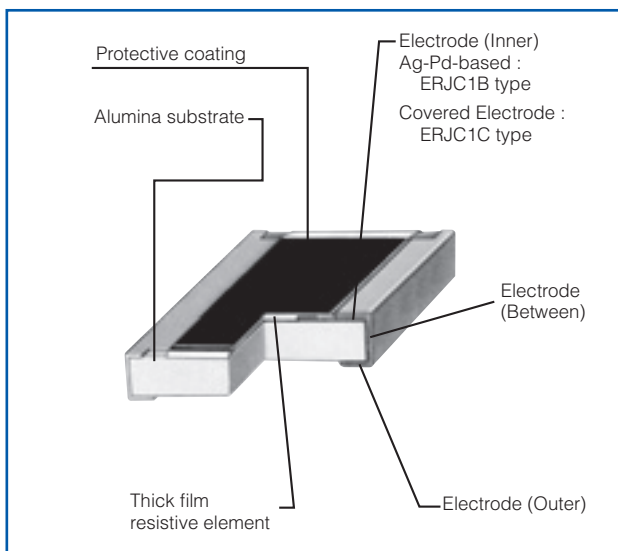

Dimensions in mm (not to scale)

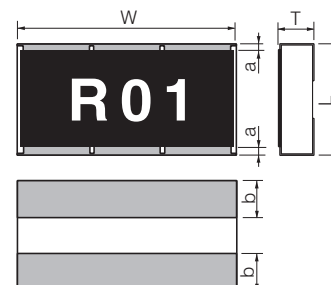

Part No.	Dimensions (mm)					Mass (Weight) [g/1000 pcs.]
	L	W	T	a	b	
ERJC1B	2.50±0.20	5.00±0.20	0.55±0.20	0.35±0.20	0.90±0.20	27
ERJC1C				0.60±0.20		

Circuit Configuration

Type ERJC1

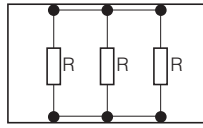

Ratings

Part No. (inch size)	Power Rating at 70 °C ⁽¹⁾ (W)	Resistance Tolerance (%)	Resistance Range (Ω)	T.C.R. (× 10 ⁻⁶ /°C)	Category Temperature Range (°C)	AEC-Q200 Grade
ERJC1 (1020)	2	±1	10m to 1 (E24)	10m Ω ≤ R < 22m Ω : ±350 22m Ω ≤ R < 47m Ω : ±200 47m Ω ≤ R < 100m Ω : ±150 100m Ω ≤ R ≤ 1 Ω : ±100	-55 to +155	Grade 0
		±5		10m Ω ≤ R < 22m Ω : ±350 22m Ω ≤ R < 1 Ω : ±200		

(1) Use it on the condition that the case temperature is below the upper category temperature.

- Rated Continuous Working Voltage (RCWV) shall be determined from $RCWV = \sqrt{\text{Power Rating} \times \text{Resistance Values}}$.
- Overload Test Voltage (OTV) shall be determined from $OTV = \text{Specified Magnification (refer to performance)} \times RCWV$.

Power Derating Curve

For resistors operated in ambient temperatures above 70 °C, power rating shall be derated in accordance with the figure on the right.

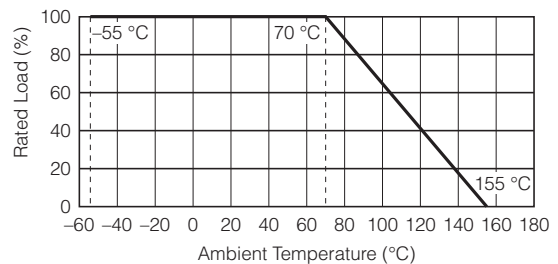

Performance

Test Item	Performance Requirements	Test Conditions
Resistance	Within Specified Tolerance	20 °C
T. C. R.	Within Specified T. C. R.	+25 °C/+125 °C
Overload	±2%	Rated Voltage × 2.0, 5 s
Resistance to Soldering Heat	±1%	270 °C, 10 s
Rapid Change of Temperature	±2%	-55 °C (30min.) / +125 °C (30min.), 1000 cycles
High Temperature Exposure	±1%	+155 °C, 1000 h
Damp Heat, Steady State	±1%	60 °C, 90% to 95 %RH, 1000 h
Load Life in Humidity	±3%	60 °C, 90% to 95 %RH, Rated Voltage, 1.5 h ON/0.5 h OFF cycle, 1000 h
Endurance at 70 °C	±3%	70 °C, Rated Voltage, 1.5 h ON/0.5 h OFF cycle, 1000 h

Chip Resistor Array

Type: **EXB 14V, 18V, 24V, 28V, N8V, 2HV, 34V, V4V, 38V, V8V, S8V**

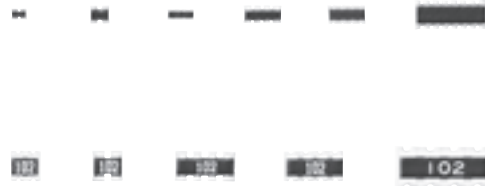

Features

- High density
 2 resistors in 0.8 mm × 0.6 mm size / 0302 inch size : EXB14V
 4 resistors in 1.4 mm × 0.6 mm size / 0502 inch size : EXB18V
 2 resistors in 1.0 mm × 1.0 mm size / 0404 inch size : EXB24V
 4 resistors in 2.0 mm × 1.0 mm size / 0804 inch size : EXB28V, EXBN8V
 8 resistors in 3.8 mm × 1.6 mm size / 1506 inch size : EXB2HV
 2 resistors in 1.6 mm × 1.6 mm size / 0606 inch size : EXB34V, EXBV4V
 4 resistors in 3.2 mm × 1.6 mm size / 1206 inch size : EXB38V, EXBV8V
 4 resistors in 5.1 mm × 2.2 mm size / 2009 inch size : EXBS8V
- Improvement of placement efficiency
 Placement efficiency of Chip Resistor Array is two, four or eight times of the flat type chip resistor
- Reference Standard...IEC 60115-9, JIS C 5201-9, EIAJ RC-2129
- AEC-Q200 qualified (EXB2, EXB3)
- RoHS compliant

■ **As for Packaging Methods, Land Pattern, Soldering Conditions and Safety Precautions,**
 Please see Data Files

Explanation of Part Numbers

1	2	3	4	5	6	7	8	9	10	11
E	X	B	V	8	V	4	7	2	J	V

Product Code	Code	Inch	Construction	Schematics	Resistance Value	Resistance Tolerance	Packaging Methods		
Thick Film Chip Resistor Networks	14	0201×2	Convex Terminal	V Isolated type	The first two digits are significant figures of resistance value and the third one denotes the number of zeros following. Jumper is expressed by R00 Example : 222 → 2.2k Ω	J ±5 % 0 Jumper	Code	Packaging	Part No.
	18	0201×4	Flat Terminal				Nil	Embossed Carrier Taping 4 mm pitch, 2,500 pcs.	EXBS8V
	24	0402×2	Convex Terminal	X		Punched Carrier Taping 2 mm pitch, 10,000 pcs.	EXB14V, 18V, 24V, 28V, N8V		
	28	0402×4	Convex Terminal	V		Punched Carrier Taping 4 mm pitch, 5,000 pcs.	EXB2HV, 34V, 38V, V4V, V8V		
	2H	0602×8	Convex Terminal						
	34	0603×2	Convex Terminal						
	38	0603×4	Convex Terminal						
	N8	0402×4	Concave Terminal						
	V4	0603×2	Concave Terminal						
	V8	0603×4	Concave Terminal						
	S8	0805×4	Concave Terminal						

Construction (Example : Concave Terminal)

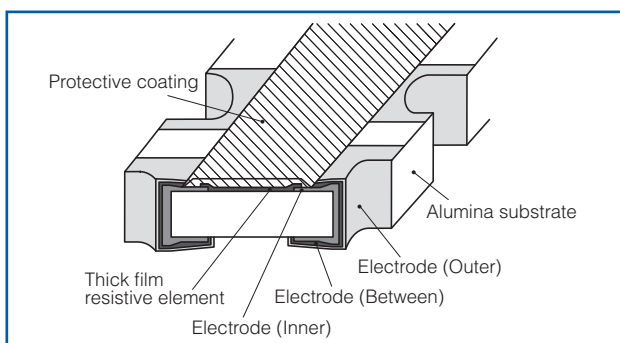

Schematics

- Isolated type

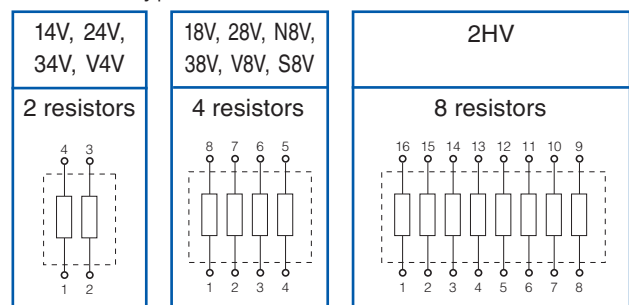

Ratings

[For Resistor]

Part No. (inch size)	Power Rating at 70 °C (W / element)	Limiting Element Voltage ⁽¹⁾ (V)	Maximum Overload Voltage ⁽²⁾ (V)	Resistance Tolerance (%)	Resistance Range (Ω)	T.C.R. ($\times 10^{-6}/^{\circ}\text{C}$)	Category Temperature Range (°C)	AEC-Q200 Grade
EXB14V (0201×2)	0.031	12.5	25	±5	10 to 1M (E24)	$<10 \Omega$: -200 to +600 10Ω to $1\text{M} \Omega$: ±200	-55 to +125	-
EXB18V (0201×2)	0.031 (0.1 W / package)	12.5	25	±5	10 to 1M (E24)		-55 to +125	-
EXB24V (0402×2)	0.063	50	100	±5	1 to 1M (E24)		-55 to +125	Grade 1
EXB28V (0402×4)	0.063	50	100	±5	1 to 1M (E24)		-55 to +125	Grade 1
EXB2HV (0602×8)	0.063 (0.25 W / package)	25	50	±5	10 to 1M (E24)		-55 to +125	Grade 1
EXB34V (0603×2)	0.063	50	100	±5	1 to 1M (E24)		-55 to +125	Grade 1
EXB38V (0603×4)	0.063	50	100	±5	1 to 1M (E24)		-55 to +125	Grade 1
EXBN8V (0402×4)	0.031	50	100	±5	10 to 1M (E24)		-55 to +125	-
EXBV4V (0603×2)	0.063	50	100	±5	10 to 1M (E24)		-55 to +125	-
EXBV8V (0603×4)	0.063	50	100	±5	10 to 1M (E24)		-55 to +125	-
EXBS8V (0805×4)	0.1	100	200	±5	10 to 1M (E24)		-55 to +125	-

- (1) Rated Continuous Working Voltage (RCWW) shall be determined from $\text{RCWW} = \sqrt{\text{Power Rating} \times \text{Resistance Values}}$, or Limiting Element Voltage listed above, whichever less.
 (2) Overload Test Voltage (OTV) shall be determined from $\text{OTV} = \text{Specified Magnification (refer to performance)} \times \text{RCWW}$ or Maximum Overload Voltage listed above, whichever less.

[For Jumper]

Part No. (inch size)	Rated Current (A / element)	Maximum Overload Current ⁽¹⁾ (A)
EXB14V (0201×2)	0.5	1
EXB18V (0201×4)	0.5	1
EXB24V (0402×2)	1	2
EXB28V (0402×4)	1	2
EXB2HV (0602×8)	1	2
EXB34V (0603×2)	1	2
EXB38V (0603×4)	1	2
EXBN8V (0402×4)	1	2
EXBV4V (0603×2)	1	2
EXBV8V (0603×4)	1	2
EXBS8V (0805×4)	2	4

(1) Overload test current

Power Derating Curve

For resistors operated in ambient temperatures above 70 °C, power rating shall be derated in accordance with the figure below.

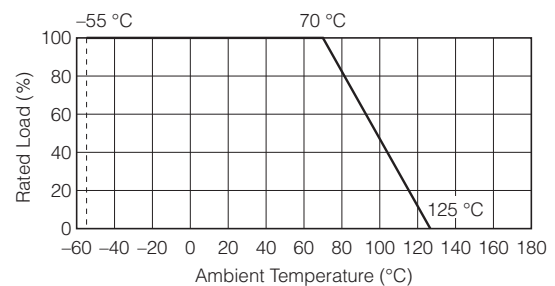

Dimensions in mm (not to scale)

(1) Convex Terminal type

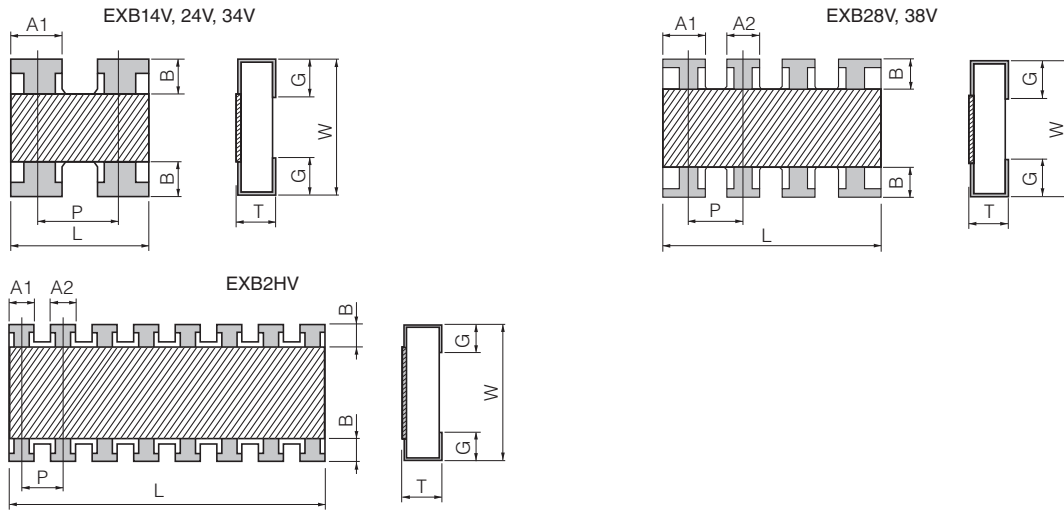

Part No. (inch size)	Dimensions (mm)								Mass (Weight) [g/1000 pcs.]
	L	W	T	A1	A2	B	P	G	
EXB14V (0201×2)	0.80 ^{±0.10}	0.60 ^{±0.10}	0.35 ^{±0.10}	0.35 ^{±0.10}	—	0.15 ^{±0.10}	(0.50)	0.15 ^{±0.10}	0.5
EXB24V (0402×2)	1.00 ^{±0.10}	1.00 ^{±0.10}	0.35 ^{±0.10}	0.40 ^{±0.10}	—	0.18 ^{±0.10}	(0.65)	0.25 ^{±0.10}	1.2
EXB28V (0402×4)	2.00 ^{±0.10}	1.00 ^{±0.10}	0.35 ^{±0.10}	0.45 ^{±0.10}	0.35 ^{±0.10}	0.20 ^{±0.10}	(0.50)	0.25 ^{±0.10}	2.0
EXB2HV (0602×8)	3.80 ^{±0.10}	1.60 ^{±0.10}	0.45 ^{±0.10}	0.35 ^{±0.10}	0.35 ^{±0.10}	0.30 ^{±0.10}	(0.50)	0.30 ^{±0.10}	9.0
EXB34V (0603×2)	1.60 ^{±0.20}	1.60 ^{±0.15}	0.50 ^{±0.10}	0.65 ^{±0.15}	—	0.30 ^{±0.20}	(0.80)	0.30 ^{±0.20}	3.5
EXB38V (0603×4)	3.20 ^{±0.20}	1.60 ^{±0.15}	0.50 ^{±0.10}	0.65 ^{±0.15}	0.45 ^{±0.15}	0.30 ^{±0.20}	(0.80)	0.35 ^{±0.20}	7.0

() Reference

(2) Concave Terminal type

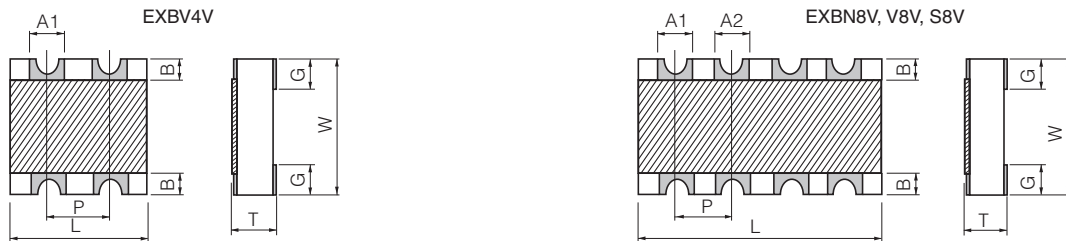

Part No. (inch size)	Dimensions (mm)								Mass (Weight) [g/1000 pcs.]
	L	W	T	A1	A2	B	P	G	
EXBN8V (0402×4)	2.00 ^{±0.10}	1.00 ^{±0.10}	0.45 ^{±0.10}	0.30 ^{±0.10}	0.30 ^{±0.10}	0.20 ^{±0.15}	(0.50)	0.30 ^{±0.15}	3.0
EXBV4V (0603×2)	1.60 ^{+0.20/-0.10}	1.60 ^{+0.20/-0.10}	0.60 ^{±0.10}	0.60 ^{±0.10}	—	0.30 ^{±0.15}	(0.80)	0.45 ^{±0.15}	5.0
EXBV8V (0603×4)	3.20 ^{+0.20/-0.10}	1.60 ^{+0.20/-0.10}	0.60 ^{±0.10}	0.60 ^{±0.10}	0.60 ^{±0.10}	0.30 ^{±0.15}	(0.80)	0.45 ^{±0.15}	10
EXBS8V (0805×4)	5.08 ^{+0.20/-0.10}	2.20 ^{+0.20/-0.10}	0.70 ^{±0.20}	0.80 ^{±0.15}	0.80 ^{±0.15}	0.50 ^{±0.15}	(1.27)	0.55 ^{±0.15}	30

() Reference

(3) Flat Terminal type

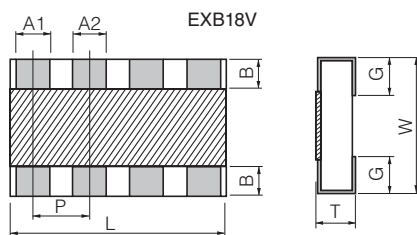

Part No. (inch size)	Dimensions (mm)								Mass (Weight) [g/1000 pcs.]
	L	W	T	A1	A2	B	P	G	
EXB18V (0201×4)	1.40±0.10	0.60±0.10	0.35±0.10	0.20±0.10	0.20±0.10	0.10±0.10	(0.40)	0.20±0.10	1.0

() Reference

Design and specifications are each subject to change without notice. Ask factory for the current technical specifications before purchase and/or use.
Should a safety concern arise regarding this product, please be sure to contact us immediately.

Performance

Test Item	Performance Requirements	Test Conditions
Resistance	Within Specified Tolerance	20 °C
T. C. R.	Within Specified T. C. R.	+25 °C/+125 °C
Overload	±2%	Rated Voltage × 2.5, 5 s Jumper type : Max. Overload Current, 5 s
Resistance to Soldering Heat	±1%	270 °C, 10 s
Rapid Change of Temperature	±1%	-55 °C (30min.) / +125 °C (30min.), 100 cycles
High Temperature Exposure	±1%	+125 °C , 1000 h
Damp Heat, Steady State	±1%	60 °C, 90% to 95 %RH, 1000 h
Load Life in Humidity	±3%	60 °C, 90% to 95 %RH, Rated Voltage (Jumper type: Rated Current), 1.5 h ON/0.5 h OFF cycle, 1000 h
Endurance at 70 °C	±3%	70 °C, Rated Voltage(Jumper type: Rated Current), 1.5 h ON/0.5 h OFF cycle, 1000 h

Anti-Sulfurated Chip Resistor Array

Type: **EXB U14, U18, U24, U28, U2H, U34, U38**

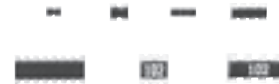

Features

- High resistance to sulfurization achieved by adopting an Ag-Pd-based inner electrode
- High density
 - 2 resistors in 0.8 mm × 0.6 mm size / 0302 inch size : EXBU14
 - 4 resistors in 1.4 mm × 0.6 mm size / 0502 inch size : EXBU18
 - 2 resistors in 1.0 mm × 1.0 mm size / 0404 inch size : EXBU24
 - 4 resistors in 2.0 mm × 1.0 mm size / 0804 inch size : EXBU28
 - 8 resistors in 3.8 mm × 1.6 mm size / 1506 inch size : EXBU2H
 - 2 resistors in 1.6 mm × 1.6 mm size / 0606 inch size : EXBU34
 - 4 resistors in 3.2 mm × 1.6 mm size / 1206 inch size : EXBU38
- Improvement of placement efficiency
Placement efficiency of Chip Resistor Array is two, four or eight times of the flat type chip resistor
- Reference Standard...IEC 60115-9, JIS C 5201-9, EIAJ RC-2129
- AEC-Q200 qualified (EXBU2, EXBU3)
- RoHS compliant

As for Packaging Methods, Land Pattern, Soldering Conditions and Safety Precautions,
Please see Data Files

Explanation of Part Numbers

1	2	3	4	5	6	7	8	9	10	11
E	X	B	U	2	8	4	7	2	J	X

Product Code	Code	Inch	Construction	Resistance Value		Resistance Tolerance	Packaging Methods	
				Code	Packaging		Part No.	
Thick Film Chip Resistor Networks	U14	0201×2	Convex Terminal	The first two digits are significant figures of resistance value and the third one denotes the number of zeros following. Jumper is expressed by R00 Example : 222 → 2.2k Ω	J ±5 % 0 Jumper	X	Punched Carrier Taping 2 mm pitch, 10,000 pcs.	EXBU14, U18, U24, U28
	U18	0201×4	Flat Terminal					
	U24	0402×2	Convex Terminal			V	Punched Carrier Taping 4 mm pitch, 5,000 pcs.	EXBU2H, U34, U38
	U28	0402×4	Convex Terminal					
	U2H	0602×8	Convex Terminal					
	U34	0603×2	Convex Terminal					
	U38	0603×4	Convex Terminal					

Construction

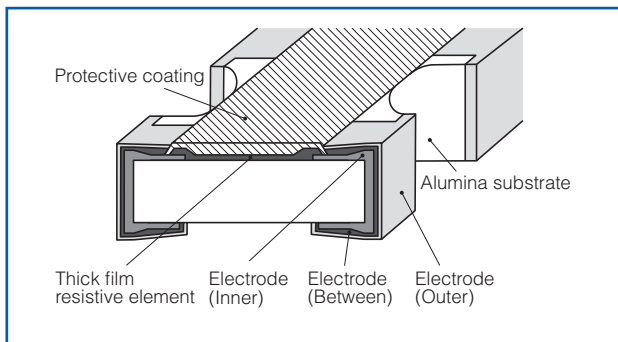

Schematics

- Isolated type

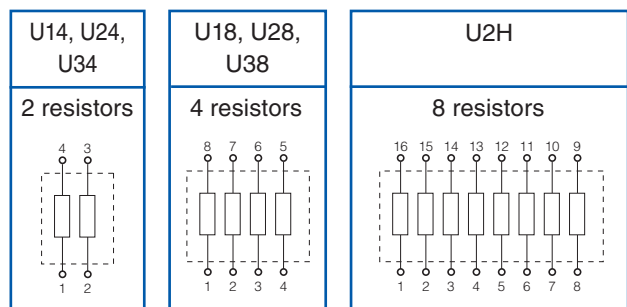

Ratings

[For Resistor]

Part No. (inch size)	Power Rating at 70 °C (W / element)	Limiting Element Voltage ⁽¹⁾ (V)	Maximum Overload Voltage ⁽²⁾ (V)	Resistance Tolerance (%)	Resistance Range (Ω)	T.C.R. (×10 ⁻⁶ /°C)	Category Temperature Range (°C)	AEC-Q200 Grade
EXBU14 (0201×2)	0.031	12.5	25	±5	10 to 1M (E24)	<10 Ω : -200 to +600 10 Ω to 1M Ω : ±200	-55 to +125	-
EXBU18 (0201×4)	0.031 (0.1 W / package)	12.5	25	±5	10 to 1M (E24)		-55 to +125	-
EXBU24 (0402×2)	0.063	50	100	±5	1 to 1M (E24)		-55 to +125	Grade 1
EXBU28 (0402×4)	0.063	50	100	±5	1 to 1M (E24)		-55 to +125	Grade 1
EXBU2H (0602×8)	0.063 (0.25 W / package)	25	50	±5	10 to 1M (E24)		-55 to +125	Grade 1
EXBU34 (0603×2)	0.063	50	100	±5	1 to 1M (E24)		-55 to +125	Grade 1
EXBU38 (0603×4)	0.063	50	100	±5	1 to 1M (E24)		-55 to +125	Grade 1

- (1) Rated Continuous Working Voltage (RCWV) shall be determined from $RCWV = \sqrt{\text{Power Rating} \times \text{Resistance Values}}$, or Limiting Element Voltage listed above, whichever less.
 (2) Overload Test Voltage (OTV) shall be determined from $OTV = \text{Specified Magnification (refer to performance)} \times RCWV$ or Maximum Overload Voltage listed above, whichever less.

[For Jumper]

Part No. (inch size)	Rated Current (A / element)	Maximum Overload Current ⁽¹⁾ (A)
EXBU24 (0402×2)	1	2
EXBU28 (0402×4)		
EXBU2H (0602×8)		
EXBU34 (0603×2)		
EXBU38 (0603×4)		

(1) Overload test current

Power Derating Curve

For resistors operated in ambient temperatures above 70 °C, power rating shall be derated in accordance with the figure below.

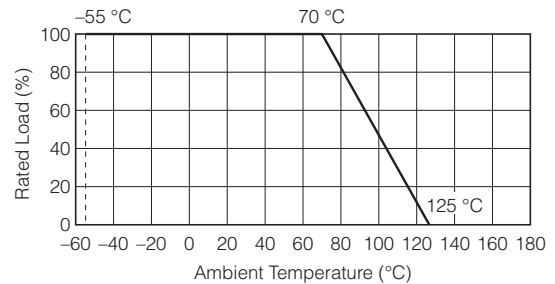

Dimensions in mm (not to scale)

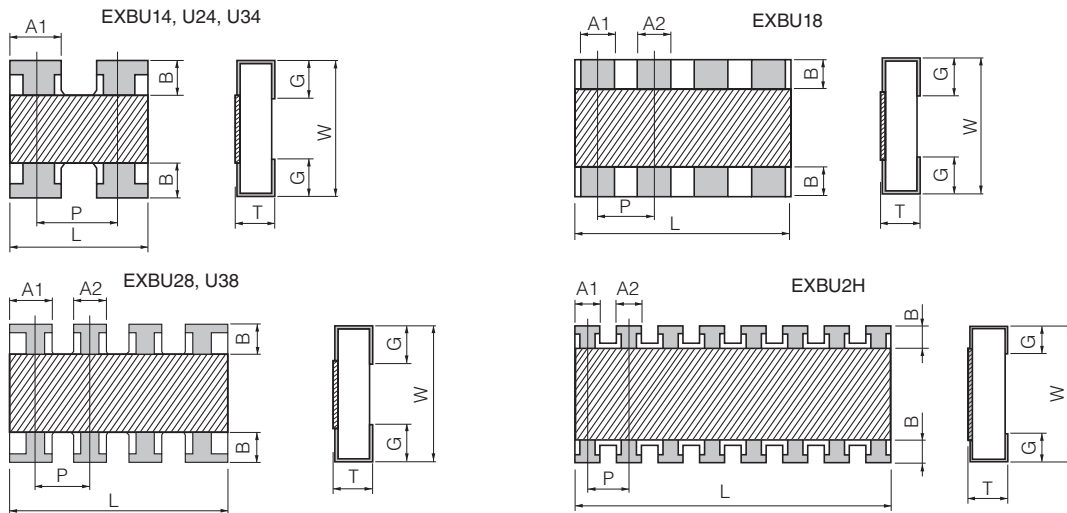

Part No. (inch size)	Dimensions (mm)								Mass (Weight) [g/1000 pcs.]
	L	W	T	A1	A2	B	P	G	
EXBU14 (0201×2)	0.80 ^{±0.10}	0.60 ^{±0.10}	0.35 ^{±0.10}	0.35 ^{±0.10}	—	0.15 ^{±0.10}	(0.50)	0.15 ^{±0.10}	0.5
EXBU18 (0201×4)	1.40 ^{±0.10}	0.60 ^{±0.10}	0.35 ^{±0.10}	0.20 ^{±0.10}	0.20 ^{±0.10}	0.10 ^{±0.10}	(0.40)	0.20 ^{±0.10}	1.0
EXBU24 (0402×2)	1.00 ^{±0.10}	1.00 ^{±0.10}	0.35 ^{±0.10}	0.40 ^{±0.10}	—	0.18 ^{±0.10}	(0.65)	0.25 ^{±0.10}	1.2
EXBU28 (0402×4)	2.00 ^{±0.10}	1.00 ^{±0.10}	0.35 ^{±0.10}	0.45 ^{±0.10}	0.35 ^{±0.10}	0.20 ^{±0.10}	(0.50)	0.25 ^{±0.10}	2.0
EXBU2H (0602×8)	3.80 ^{±0.10}	1.60 ^{±0.10}	0.45 ^{±0.10}	0.35 ^{±0.10}	0.35 ^{±0.10}	0.30 ^{±0.10}	(0.50)	0.30 ^{±0.10}	9.0
EXBU34 (0603×2)	1.60 ^{±0.20}	1.60 ^{±0.15}	0.50 ^{±0.10}	0.65 ^{±0.15}	—	0.30 ^{±0.20}	(0.80)	0.30 ^{±0.20}	3.5
EXBU38 (0603×4)	3.20 ^{±0.20}	1.60 ^{±0.15}	0.50 ^{±0.10}	0.65 ^{±0.15}	0.45 ^{±0.15}	0.30 ^{±0.20}	(0.80)	0.35 ^{±0.20}	7.0

() Reference

Performance

Test Item	Performance Requirements	Test Conditions
Resistance	Within Specified Tolerance	20 °C
T. C. R.	Within Specified T. C. R.	+25 °C/+125 °C
Overload	±2%	Rated Voltage × 2.5, 5 s Jumper type : Max. Overload Current, 5 s
Resistance to Soldering Heat	±1%	270 °C, 10 s
Rapid Change of Temperature	±1%	-55 °C (30min.) / +125 °C (30min.), 100 cycles
High Temperature Exposure	±1%	+125 °C, 1000 h
Damp Heat, Steady State	±1%	60 °C, 90% to 95 %RH, 1000 h
Load Life in Humidity	±3%	60 °C, 90% to 95 %RH, Rated Voltage (Jumper type: Rated Current), 1.5 h ON/0.5 h OFF cycle, 1000 h
Endurance at 70 °C	±3%	70 °C, Rated Voltage(Jumper type: Rated Current), 1.5 h ON/0.5 h OFF cycle, 1000 h

Chip Resistor Networks

Type: **EXBD**
EXBE
EXBA
EXBQ



Features

- High density placing for digital signal circuits
 - Bussed 8 or 15 resistors for pull up/down circuits
 - EXBD: 3.2 mm × 1.6 mm × 0.55 mm, 0.635 mm pitch
 - EXBE: 4.0 mm × 2.1 mm × 0.55 mm, 0.8 mm pitch
 - EXBA: 6.4 mm × 3.1 mm × 0.55 mm, 1.27 mm pitch
 - EXBQ: 3.8 mm × 1.6 mm × 0.45 mm, 0.5 mm pitch
 - Available direct placing on the bus line by means of half pitch spacing without through-holes on PWB (“High density placing” is shown below)
- High speed mounting using conventional placing machine
- Reference Standard...IEC 60115-9, JIS C 5201-9, EIAJ RC-2130
- RoHS compliant

[High density placing]

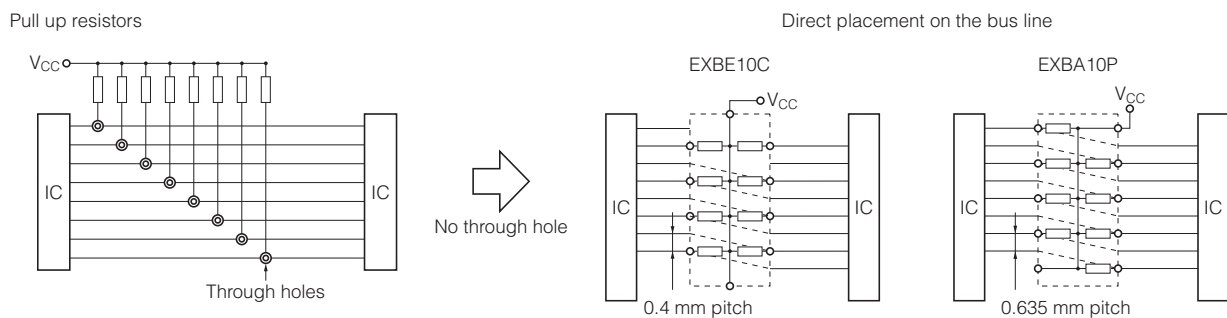

■ **As for Packaging Methods, Land Pattern, Soldering Conditions and Safety Precautions,**
 Please see Data Files

Explanation of Part Numbers

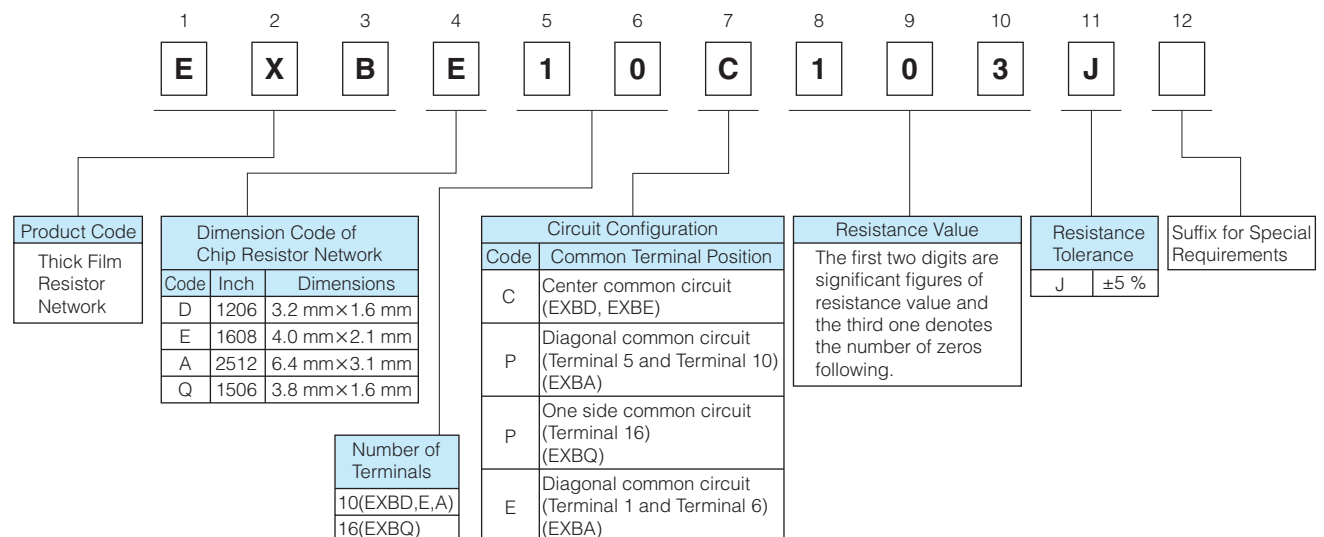

Construction (Example : EXBD)

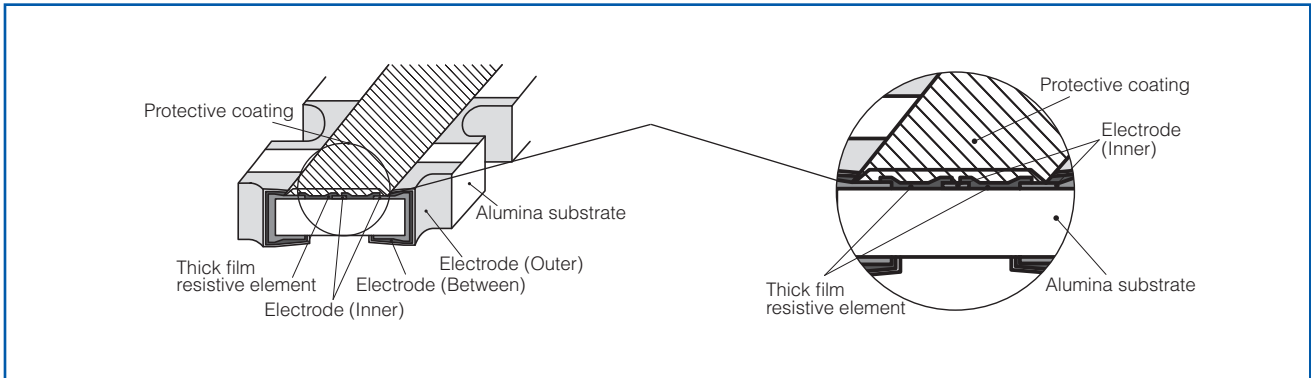

Dimensions in mm (not to scale)

<p style="text-align: center;">EXBD</p> <p style="text-align: center;">Mass (Weight)[1000 pcs.] : 10 g</p>	<p style="text-align: center;">EXBE</p> <p style="text-align: center;">Mass (Weight)[1000 pcs.] : 16 g</p>
<p style="text-align: center;">EXBA</p> <p style="text-align: center;">Mass (Weight)[1000 pcs.] : 40 g</p>	<p style="text-align: center;">EXBQ</p> <p style="text-align: center;">Mass (Weight)[1000 pcs.] : 9 g</p>

Circuit Configuration

<p style="text-align: center;">EXBD, EXBE</p>	<p style="text-align: center;">EXBA</p> <p style="text-align: center;">EXBA10P</p> <p style="text-align: center;">EXBA10E</p>	<p style="text-align: center;">EXBQ</p>
--	--	--

Ratings

Item	Specifications				
	Part No.	EXBD	EXBE	EXBA	EXBQ
Resistance Range (Ω)	47 to 1M (E12 series)			100 to 470k (E6 series)	
Resistance Tolerance (%)	±5				
Number of Terminals	10 terminals			16 terminals	
Number of Resistors	8 element			15 element	
Power Rating ⁽³⁾ at 70 °C (W)	0.05 /element	0.063 /element		0.025 /element	
Limiting Element Voltage ⁽¹⁾ (V)	25		50		25
Maximum Overload Voltage ⁽²⁾ (V)	50		100		50
T. C. R. ($\times 10^{-6}/^{\circ}\text{C}$)	±200				
Category Temperature Range ($^{\circ}\text{C}$)	-55 to +125				
AEC-Q200 Grade	-				

- (1) Rated Continuous Working Voltage (RCWV) shall be determined from $\text{RCWV} = \sqrt{\text{Power Rating} \times \text{Resistance Values}}$, or Limiting Element Voltage listed above, whichever less.
 (2) Overload Test Voltage (OTV) shall be determined from $\text{OTV} = \text{Specified Magnification (refer to performance)} \times \text{RCWV}$ or Maximum Overload Voltage listed above, whichever less.
 (3) Use it on the condition that the case temperature is below the upper category temperature.

Power Derating Curve

For resistors operated in ambient temperatures above 70 °C, power rating shall be derated in accordance with the figure on the right.

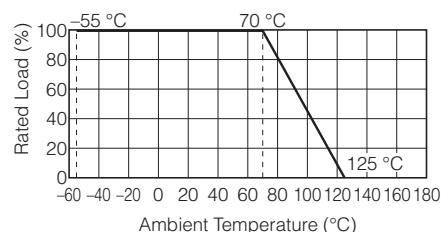

Performance

Test Item	Performance Requirements	Test Conditions
Resistance	Within Specified Tolerance	20 °C
T. C. R.	Within Specified T. C. R.	+25 °C/+125 °C
Overload	±3 %	Rated Voltage \times 2.5, 5 s
Resistance to Soldering Heat	±1 %	260 °C \pm 5 °C, 5 s \pm 1 s
Rapid Change of Temperature	±2 %	-55 °C (30min.) / +125 °C (30min.), 5 cycles
High Temperature Exposure	±3 %	+125 °C , 100 h
Load Life in Humidity	±3 %	60 °C \pm 2 °C, 90 % to 95 %RH, Rated Power \times 0.1, 1.5 h ON / 0.5 h OFF cycle, 500 h
Endurance at 70 °C	±5 %	70 °C \pm 2 °C, Rated Voltage, 1.5 h ON / 0.5 h OFF cycle, 1000 h

Chip Attenuator

Type: **EXB 14AT**
EXB 24AT



Features

- Unbalanced π type attenuator circuit in one chip
EXB14AT (0.8 mm × 0.6 mm), EXB24AT (1.0 mm × 1.0 mm)
- Reduced mounting area :
EXB14AT : About 60 % smaller than the area of an attenuator circuit consisting of three 0603 chip resistors, almost equal to the area of three 0402 chip resistors
EXB24AT : About 50 % smaller than the area of an attenuator circuit consisting of three 1005 chip resistors, almost equal to the area of three 0603 chip resistors
- Mounting cost reduction : (Only 1 chip placed as compared to 3)
- Attenuation : 1 dB to 10 dB
- RoHS compliant

Recommended Applications

- Attenuation / level control / impedance matching of high frequency
(communication signalling equipment cellular phones(GSM, CDMA, PDC, etc.), PHS, PDAs)

As for Packaging Methods, Land Pattern, Soldering Conditions and Safety Precautions,
Please see Data Files

Explanation of Part Numbers

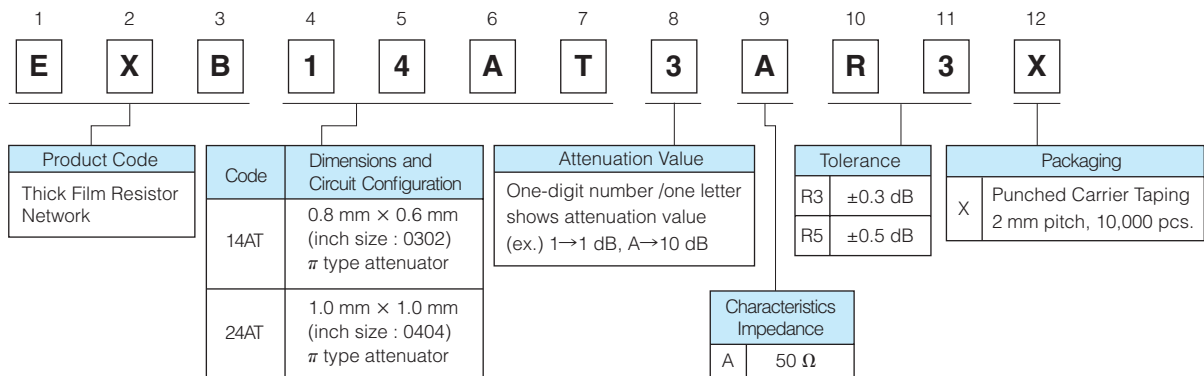

Attenuation-Frequency Characteristics

(EXB14AT, EXB24AT)

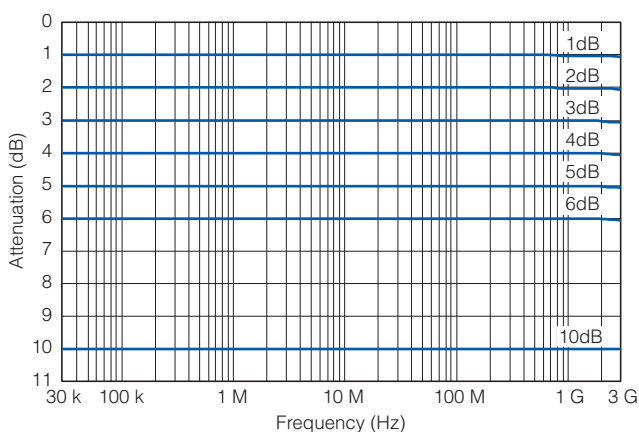

Circuit Configuration

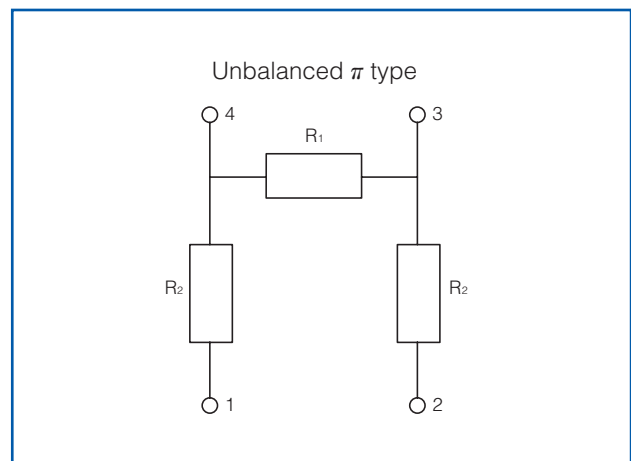

Construction

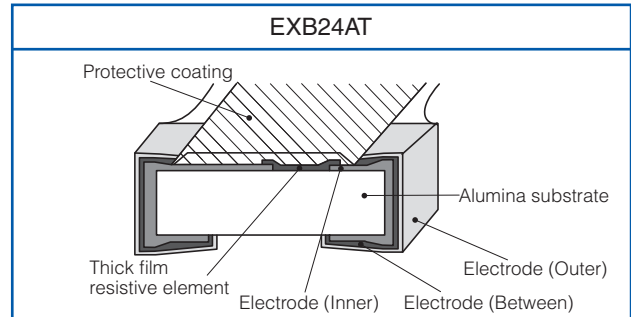
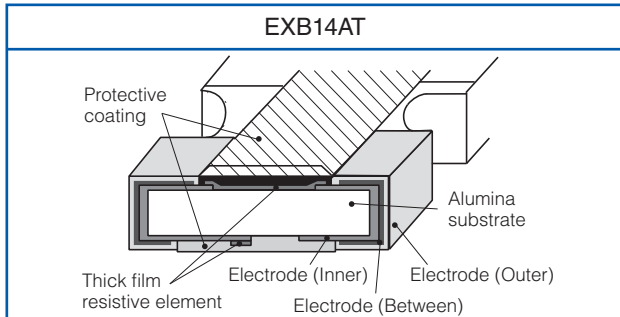

Dimensions in mm (not to scale)

EXB14AT

Dimensions (mm)	L	W	T	A	B	C	P (typical value)
	0.80 ^{+0.10}	0.60 ^{+0.10}	0.35 ^{+0.10}	0.35 ^{+0.10}	0.15 ^{+0.10}	0.15 ^{+0.10}	0.50

<Marking Configuration>
 The bar marking for recognizing terminal direction is located on the side of terminal 3, 4.
 Mass (Weight) [1000 pcs.] : 0.7 g

EXB24AT

Dimensions (mm)	L	W	T	A	B	C	P (typical value)
	1.00 ^{+0.10}	1.00 ^{+0.10}	0.35 ^{+0.10}	0.40 ^{+0.10}	0.15 ^{+0.10}	0.25 ^{+0.10}	0.65

<Marking Configuration>
 The bar marking for recognizing terminal direction is located on the side of terminal 4.
 Mass (Weight) [1000 pcs.] : 1.1 g

Ratings

Part No.	EXB14AT, EXB24AT
Attenuation Value	1 dB, 2 dB, 3 dB, 4 dB, 5 dB, 6 dB, 10 dB*
Attenuation Value Tolerance	1 dB, 2 dB, 3 dB, 4 dB, 5 dB : ±0.3 dB 6 dB, 10 dB : ±0.5 dB
Characteristic Impedance	50 Ω
Power Rating	0.04 W /package
Frequency Range at 70 °C	DC to 3.0 GHz
VSWR (Voltage Standing Wave Ratio)	1.3 max.
Number of Resistors	3 resistors
Number of Terminals	4 terminals
Category Temperature Range	-55 °C to +125 °C

* Please inquire about the other Attenuator value

Power Derating Curve

For resistors operated in ambient temperatures above 70 °C, power rating shall be derated in accordance with the figure on the right.

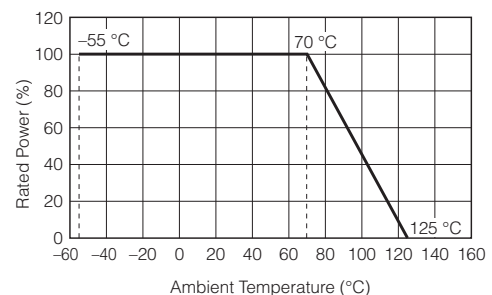

Surface Mount Resistors Series			Packaging (Standard Quantity : pcs./reel)			
Products	Part No.	Size mm (inch)	Pressed Carrier Taping (2 mm pitch)	Punched Carrier Taping (2 mm pitch)	Punched Carrier Taping (4 mm pitch)	Embossed Carrier Taping (4 mm pitch)
Thick Film Chip Resistors	ERJXGN	0402(01005)	20,000 *	—	—	4,0000 **
	ERJ1GN	0603(0201)	15,000	—	—	—
	ERJ2GE	1005(0402)	—	10,000, 20,000	—	—
	ERJ3GE	1608(0603)	—	—	5,000	—
	ERJ6GE	2012(0805)	—	—	5,000	—
	ERJ8GE	3216(1206)	—	—	5,000	—
	ERJ14	3225(1210)	—	—	—	5,000
	ERJ12	4532(1812)	—	—	—	5,000
	ERJ12Z	5025(2010)	—	—	—	5,000
	ERJ1T	6432(2512)	—	—	—	4,000
Precision Thick Film Chip Resistors	ERJXGN	0402(01005)	20,000 *	—	—	4,0000 **
	ERJ1GN/1RH	0603(0201)	15,000	—	—	—
	ERJ2RC/2RH/2RK	1005(0402)	—	10,000	—	—
	ERJ3RB/3RE/3EK	1608(0603)	—	—	5,000	—
	ERJ6RB/6RE/6EN	2012(0805)	—	—	5,000	—
	ERJ8EN	3216(1206)	—	—	5,000	—
	ERJ14N	3225(1210)	—	—	—	5,000
	ERJ12N	4532(1812)	—	—	—	5,000
	ERJ12S	5025(2010)	—	—	—	5,000
	ERJ1TN	6432(2512)	—	—	—	4,000
Metal Film (Thin Film) Chip Resistors, High Reliability Type /Anti-ESD Type	ERA1A	0603(0201)	15,000	—	—	—
	ERA2A/2V	1005(0402)	—	10,000	—	—
	ERA3A/3V	1608(0603)	—	—	5,000	—
	ERA6A/6V	2012(0805)	—	—	5,000	—
	ERA8A	3216(1206)	—	—	5,000	—
Thick Film Chip Resistors/ Low Resistance Type	ERJ2LW/2BW	1005(0402)	10,000	—	—	—
	ERJ2BS/2BQ	1005(0402)	—	10,000	—	—
	ERJ3L/3B/3R/L03	1608(0603)	—	—	5,000	—
	ERJ6L/6B/6C ERJ6D/6R/L06	2012(0805)	—	—	5,000	—
	ERJ8B/8C/8R/L08	3216(1206)	—	—	5,000	—
	ERJ14B/14R/L14	3225(1210)	—	—	—	5,000
	ERJ12R/L12	4532(1812)	—	—	—	5,000
	ERJ12Z/L1D	5025(2010)	—	—	—	5,000
	ERJ1TR	6432(2512)	—	—	—	4,000
	ERJL1W	6432(2512)	—	—	—	3,000
Current Sensing Resistors, Metal Plate Type	ERJMP2	3216(1206)	—	—	—	3,000
	ERJMP3	5025(2010)	—	—	—	3,000
	ERJMP4	6432(2512)	—	—	—	2,000
	ERJMS4	6432(2512)	—	—	—	2,000
	ERJMS6	6468(2526)	—	—	—	1,000 (8 mm Pitch)
	ERJMB1	2550(1020)	—	—	—	3,000
	ERJM1W	6432(2512)	—	—	—	3,000
Current Sensing Resistors, Metal Foil Type	ERJMFBA	1005(0402)	—	10,000	—	—

* W8P2 : Width 8 mm, Pitch 2 mm, ** W4P1 : Width 4 mm, Pitch 1 mm

(1) Anti-Sulfurated High Power Chip Resistors / Wide Terminal Type

Surface Mount Resistors Series			Packaging (Standard Quantity : pcs./reel)			
Products	Part No.	Size mm (inch)	Pressed Carrier Taping (2 mm pitch)	Punched Carrier Taping (2 mm pitch)	Punched Carrier Taping (4 mm pitch)	Embossed Carrier Taping (4 mm pitch)
High Power Chip Resistors/ Wide Terminal Type	ERJA1	3264(1225)	—	—	—	4,000
	ERJB1/ERJC1 ⁽¹⁾ ERJC1 ⁽²⁾	2550(1020)	—	—	—	5,000
	ERJB2/ERJD2 ⁽²⁾	1632(0612)	—	—	5,000	—
	ERJB3	1220(0508)	—	—	5,000	—
High Precision/ Anti-Surge Thick Film Chip Resistors	ERJPA2	1005(0402)	—	10,000	—	—
	ERJPB3/P03/PA3	1608(0603)	—	—	5,000	—
	ERJPB6/P06	2012(0805)	—	—	5,000	—
	ERJP08	3216(1206)	—	—	5,000	—
Anti-Pulse Thick Film Chip Resistors	ERJP14	3225(1210)	—	—	—	5,000
	ERJT06	2012(0805)	—	—	5,000	—
	ERJT08	3216(1206)	—	—	5,000	—
Anti-Sulfurated Thick Film Chip Resistors	ERJT14	3225(1210)	—	—	—	5,000
	ERJU01	0603(0201)	15,000	—	—	—
	ERJS02/U02	1005(0402)	—	10,000	—	—
	ERJS03/U03	1608(0603)	—	—	5,000	—
	ERJS06/U06 ERJU6S/U6Q/UP6	2012(0805)	—	—	5,000	—
	ERJS08/U08/UP8	3216(1206)	—	—	5,000	—
	ERJS14/U14	3225(1210)	—	—	—	5,000
	ERJS12/U12	4532(1812)	—	—	—	5,000
Chip Resistor Array	ERJS1D/U1D	5025(2010)	—	—	—	5,000
	ERJS1T/U1T	6432(2512)	—	—	—	4,000
	EXB14V	0806(0302)	—	10,000	—	—
	EXB24V	1010(0404)	—	10,000	—	—
	EXB34V	1616(0606)	—	—	5,000	—
	EXBV4V	1616(0606)	—	—	5,000	—
	EXB18V	1406(0502)	—	10,000	—	—
	EXB28V	2010(0804)	—	10,000	—	—
	EXBN8V	2010(0804)	—	10,000	—	—
	EXB38V	3216(1206)	—	—	5,000	—
	EXBV8V	3216(1206)	—	—	5,000	—
Anti-Sulfurated Chip Resistor Array	EXBS8V	5022(2009)	—	—	—	2,500
	EXB2HV	3816(1506)	—	—	5,000	—
	EXBU14	0806(0302)	—	10,000	—	—
	EXBU18	1406(0502)	—	10,000	—	—
	EXBU24	1010(0404)	—	10,000	—	—
	EXBU34	1616(0606)	—	—	5,000	—
	EXBU28	2010(0804)	—	10,000	—	—
Chip Resistor Networks	EXBU38	3216(1206)	—	—	5,000	—
	EXBU2H	3816(1506)	—	—	5,000	—
	EXBD	3216(1206)	—	—	5,000	—
	EXBE	4021(1608)	—	—	—	4,000
Chip Attenuator	EXBA	6431(2512)	—	—	—	4,000
	EXBQ	3816(1506)	—	—	5,000	—
	EXB14AT	0806(0302)	—	10,000	—	—
	EXB24AT	1010(0404)	—	10,000	—	—

(1) Anti-Sulfurated High Power Chip Resistors / Wide Terminal Type

(2) Low TCR High Power Chip Resistors / Wide Terminal Type

Carrier Tape

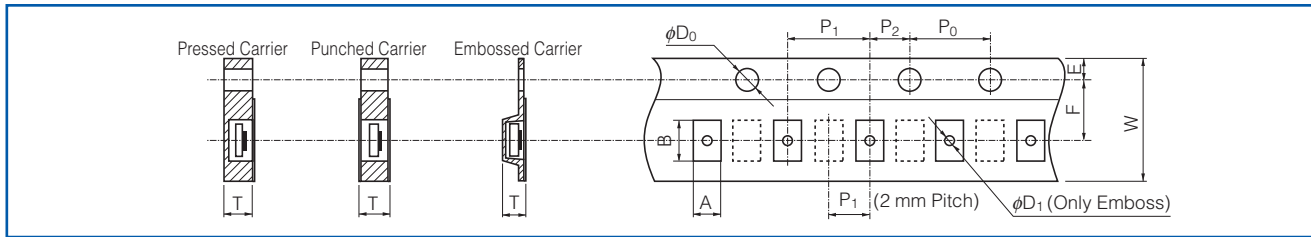

Pressed Carrier Taping (2 mm Pitch)

● Chip Resistors / Precision Chip / Metal Film(Thin Film)Chip / Low Resistance / Anti-Surge / Anti-Sulfur (Unit : mm)

Part No.	Size mm (inch)	A	B	W	F	E	P ₁	P ₂	P ₀	φD ₀	T
ERJXGN	0402(01005)	0.24 ^{±0.03}	0.45 ^{±0.03}	8.00 ^{±0.20}	3.50 ^{±0.05}	1.75 ^{±0.10}	2.00 ^{±0.10}	2.00 ^{±0.05}	4.00 ^{±0.10}	1.50 ^{+0.10} ₀	0.31 ^{±0.05}
ERJ1GN ERJ1R□ ERJU01 ERA1A	0603 (0201)	0.38 ^{±0.05}	0.68 ^{±0.05}								0.42 ^{±0.05}
ERJ2LW	1005(0402)	0.68 ^{±0.10}	1.20 ^{±0.10}								0.60 ^{±0.05}
ERJ2BW	1005(0402)	0.67 ^{±0.10}	1.17 ^{±0.10}								0.61 ^{±0.05}

Punched Carrier Taping (2 mm Pitch)

● Chip Resistors / Precision Chip / Metal Film(Thin Film)Chip / Low Resistance / Anti-Surge / Anti-Sulfur / Metal Foil Type (Unit : mm)

Part No.	Size mm (inch)	A	B	W	F	E	P ₁	P ₂	P ₀	φD ₀	T
ERJ2□ ERJPA2 ERJ□□2 ERA2□ ERJMFBA	1005 (0402)	0.67 ^{±0.05}	1.17 ^{±0.05}	8.00 ^{±0.20}	3.50 ^{±0.05}	1.75 ^{±0.10}	2.00 ^{±0.10}	2.00 ^{±0.05}	4.00 ^{±0.10}	1.50 ^{+0.10} ₀	0.52 ^{±0.05} 0.60 ^{±0.05}

● Chip Resistor Array / Anti-Sulfurated Chip Resistor Array / Chip Attenuator (Unit : mm)

Part No.	Size mm (inch)	A	B	W	F	E	P ₁	P ₂	P ₀	φD ₀	T
EXB14V EXB14AT	0806 (0302)	0.70 ^{+0.10} _{-0.05}	0.95 ^{+0.05} _{-0.10}	8.00 ^{±0.20}	3.50 ^{±0.05}	1.75 ^{±0.10}	2.00 ^{±0.10}	2.00 ^{±0.05}	4.00 ^{±0.10}	1.50 ^{+0.10} ₀	0.52 ^{±0.05}
EXB18V	1406(0502)		1.60 ^{±0.10}								
EXB24V EXBU24 EXB24AT	1010 (0404)	1.20 ^{±0.10}	1.20 ^{±0.10}								
EXB28V EXBU28 EXBN8V	2010 (0804)		2.20 ^{±0.10}								

Punched Carrier Taping (4 mm Pitch)

● Chip Resistors / Precision Chip / Metal Film(Thin Film)Chip / Low Resistance / High Power / High Precision / Anti-Surge / Anti-Pulse / Anti-Sulfur (Unit : mm)

Part No.	Size mm (inch)	A	B	W	F	E	P ₁	P ₂	P ₀	φD ₀	T
ERJ3□ ERJ3LW(10 mΩ) ERJ3BW ERJ□□3 ERA3□ ERJ3LW(5 mΩ)	1608 (0603)	1.10 ^{±0.10}	1.90 ^{±0.10}	8.00 ^{±0.20}	3.50 ^{±0.05}	1.75 ^{±0.10}	4.00 ^{±0.10}	2.00 ^{±0.05}	4.00 ^{±0.10}	1.50 ^{+0.10} ₀	0.70 ^{±0.05}
ERJ6□ ERJ□□6 ERJU6S, U6Q ERA6□ ERJB3	2012 (0805)	1.65 ^{±0.15}	2.50 ^{±0.20}								0.84 ^{±0.05}
ERJ6BW ERJ6LW ERJ6CW	2012 (0805)	1.55 ^{±0.15}	2.30 ^{±0.20}								0.94 ^{±0.05}
ERJ8□ ERJ8□W ERJ□□8 ERA8A ERJB2 ERJD2	3216 (1206) 1632 (0612)	2.00 ^{±0.15}	3.60 ^{±0.20}								0.84 ^{±0.05}

Panasonic Surface Mount Resistors Packaging Method (Taping)

● Chip Resistor Array / Anti-Sulfurated Chip Resistor Array / Chip Resistor Networks

(Unit : mm)

Part No.	Size mm (inch)	A	B	W	F	E	P ₁	P ₂	P ₀	φD ₀	T
EXB34V EXBU34	1616(0606)	1.95 ^{±0.15}	1.95 ^{±0.20}	8.00 ^{±0.20}	3.50 ^{±0.05}	1.75 ^{±0.10}	4.00 ^{±0.10}	2.00 ^{±0.05}	4.00 ^{±0.10}	1.50 ^{±0.10}	0.70 ^{±0.05}
EXB38V EXBU38	3216(1206)		3.60 ^{±0.20}								
EXB2HV EXBU2H	3816(1506)		4.10 ^{±0.15}								
EXBV4V	1616(0606)		1.95 ^{±0.20}								
EXBV8V	3216(1206)		3.60 ^{±0.20}								
EXBD	3216(1206)		2.00 ^{±0.20}								
EXBQ	3816(1506)	1.90 ^{±0.20}	4.10 ^{±0.20}	0.84 ^{±0.10}	0.64 ^{±0.05}						

Embossed Carrier Taping (1 mm Pitch)

● Chip Resistors

(Unit : mm)

Part No.	Size mm (inch)	A	B	W	F	E	P ₁	P ₂	P ₀	φD ₀	T
ERJXGN	0402(01005)	0.25 ^{±0.05}	0.45 ^{±0.05}	4.00 ^{±0.20}	1.80 ^{±0.05}	0.90 ^{±0.10}	1.00 ^{±0.10}	1.00 ^{±0.10}	2.00 ^{±0.10}	0.80 ^{±0.10}	0.5 max.

Embossed Carrier Taping (4 mm Pitch)

● Chip Resistors / Precision Chip / Low Resistance / High Power / Anti-Surge / Anti-Pulse / Anti-Sulfur Pulse / Anti-Sulfur

(Unit : mm)

Part No.	Size mm (inch)	A	B	W	F	E	P ₁	P ₂	P ₀	φD ₀	T	φD ₁	
ERJ14□ ERJ□14	3225 (1210)	2.80 ^{±0.20}	3.50 ^{±0.20}	8.00 ^{±0.30}	3.50 ^{±0.05}	1.75 ^{±0.10}	4.00 ^{±0.10}	2.00 ^{±0.05}	4.00 ^{±0.10}	1.50 ^{±0.10}	1.00 ^{±0.10}	1.00 ^{±0.10}	
ERJ12□ ERJ□12	4532 (1812)	3.50 ^{±0.20}	4.80 ^{±0.20}	12.00 ^{±0.30}	5.50 ^{±0.20}								
ERJ12Z ERJ12S ERJ□1D	5025 (2010)	2.80 ^{±0.20}	5.30 ^{±0.20}										
ERJB1 ERJC1 ERJD1	2550 (1020)												
ERJ1T□ ERJ□1T	6432 (2512)	3.60 ^{±0.20}	6.90 ^{±0.20}										1.60 ^{±0.10}
ERJL1W													
ERJA1	3264(1225)	3.50 ^{±0.20}	6.80 ^{±0.20}					1.10 ^{±0.20}					

● Current Sensing Resistors, Metal Plate Type

(Unit : mm)

Part No.	Size mm (inch)	A	B	W	F	E	P ₁	P ₂	P ₀	φD ₀	T	φD ₁
ERJMP2 (1m Ω)	3216(1206)	1.90 ^{±0.20}	3.50 ^{±0.20}	8.00 ^{±0.30}	3.50 ^{±0.10}	1.75 ^{±0.10}	4.00 ^{±0.10}	2.00 ^{±0.05}	4.00 ^{±0.10}	1.50 ^{±0.10}	1.55 ^{±0.20}	–
ERJMP2 (2m Ω)	3216(1206)										1.40 ^{±0.20}	–
ERJMP2 (3 to 50m Ω)	3216(1206)										1.10 ^{±0.20}	–
ERJMP3 (1 to 2m Ω)	5025(2010)	2.90 ^{±0.20}	5.40 ^{±0.20}	12.00 ^{±0.30}	5.50 ^{±0.10}							
ERJMP3 (3 to 50m Ω)	5025(2010)										1.55 ^{±0.20}	–
ERJMP3 (3 to 50m Ω)	5025(2010)										1.15 ^{±0.20}	–
ERJMB1	2550(1020)									1.55 ^{±0.20}	–	
ERJMP4 (1 to 2m Ω)	6432(2512)	3.50 ^{±0.20}	6.90 ^{±0.20}	12.00 ^{±0.30}	5.50 ^{±0.10}						1.60 ^{±0.20}	1.5 min.
ERJMP4 (3 to 50m Ω)	6432(2512)									1.20 ^{±0.20}	–	
ERJMS4	6432(2512)									1.60 ^{±0.20}	1.5 min.	
ERJM1W	6432(2512)									1.80 ^{±0.20}	1.5 min.	

● Chip Resistor Array / Chip Resistor Networks

(Unit : mm)

Part No.	Size mm (inch)	A	B	W	F	E	P ₁	P ₂	P ₀	φD ₀	T	φD ₁
EXBS8V	5022(2029)	2.80 ^{±0.20}	5.70 ^{±0.20}	12.00 ^{±0.30}	5.50 ^{±0.20}	1.75 ^{±0.10}	4.00 ^{±0.10}	2.00 ^{±0.05}	4.00 ^{±0.10}	1.50 ^{±0.10}	1.6 max.	1.5 min.
EXBE	4021(1608)	2.50 ^{±0.20}	4.40 ^{±0.20}								1.10 ^{±0.20}	
EXBA	6431(2512)	3.50 ^{±0.20}	6.80 ^{±0.20}									

Design and specifications are each subject to change without notice. Ask factory for the current technical specifications before purchase and/or use.
Should a safety concern arise regarding this product, please be sure to contact us immediately.

14 Aug. 2018

Embossed Carrier Taping (8 mm Pitch)

● Current Sensing Resistors, Metal Plate Type

(Unit : mm)

Part No.	Size mm (inch)	A	B	W	F	E	P ₁	P ₂	P ₀	φD ₀	T	φD ₁
ERJMS6	6468(2526)	6.90 ^{±0.20}	7.50 ^{±0.20}	12.00 ^{±0.30}	5.50 ^{±0.05}	1.75 ^{±0.10}	8.00 ^{±0.10}	2.00 ^{±0.05}	4.00 ^{±0.10}	1.50 ^{+0.10} ₀	2.45 ^{±0.20}	1.5 min.

Taping Reel

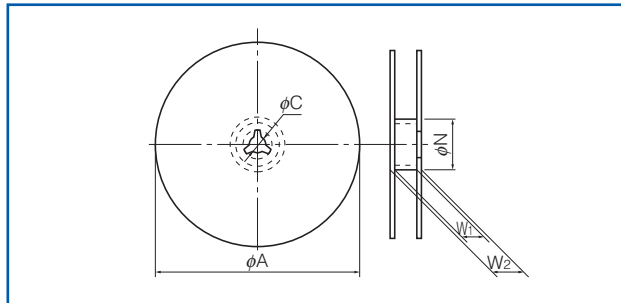

(Unit : mm)

Tape Width (W)	φA	φN	φC	W ₁	W ₂
4mm Width	180.0 ^{±3.0}	60.0 ^{+1.0} ₀	13.0 ^{±0.2}	4.5 ^{±0.5}	7.0 ^{±0.5}
8mm Width	180.0 ⁰ _{-1.5}			9.0 ^{+1.0} ₀	11.4 ^{±1.0}
12mm Width				13.0 ^{+1.0} ₀	15.4 ^{±1.0}
24mm Width	380.0 ^{±2.0}	80.0 ^{±1.0}		25.4 ^{±1.0}	29.4 ^{±1.0}

Recommended Land Pattern

- An example of a land pattern for the Rectangular Type is shown below.

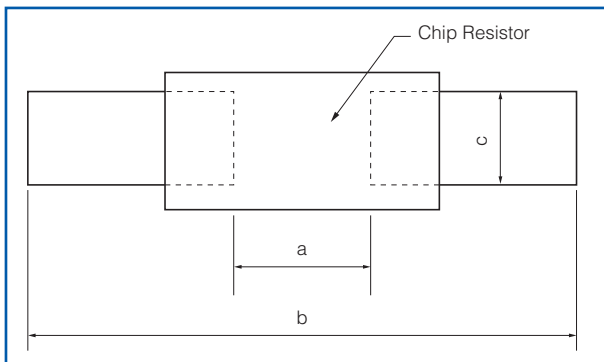

Size mm/inch	Dimensions (mm)		
	a	b	c
0402/01005	0.15 to 0.20	0.5 to 0.7	0.20 to 0.25
0603/0201	0.3 to 0.4	0.8 to 0.9	0.25 to 0.35
1005/0402	0.5 to 0.6	1.4 to 1.6	0.4 to 0.6
1608/0603	0.7 to 0.9	2.0 to 2.2	0.8 to 1.0
2012/0805	1.0 to 1.4	3.2 to 3.8	0.9 to 1.4
3216/1206	2.0 to 2.4	4.4 to 5.0	1.2 to 1.8
3225/1210	2.0 to 2.4	4.4 to 5.0	1.8 to 2.8
4532/1812	3.3 to 3.7	5.7 to 6.5	2.3 to 3.5
5025/2010	3.6 to 4.0	6.2 to 7.0	1.8 to 2.8
6432/2512	5.0 to 5.4	7.6 to 8.6	2.3 to 3.5
6432/2512*	3.6 to 4.0	7.6 to 8.6	2.3 to 3.5

High power (double-sided resistive elements structure) type

Part No.	Size mm/inch	Dimensions (mm)		
		a	b	c
ERJ2LW/2BW	1005/0402	0.52	1.4 to 1.6	0.4 to 0.6
ERJ3LW/3BW	1608/0603	0.5 to 0.8	2.5 to 2.7	0.9 to 1.1
ERJ6LW	2012/0805	0.6 to 0.8	3.2 to 3.8	1.1 to 1.4
ERJ6BW	2012/0805	0.9	3.2 to 3.8	1.1 to 1.4
ERJ6CW (10 to 13 mΩ)	2012/0805	0.7 to 0.9	3.2 to 3.8	1.1 to 1.4
ERJ6CW (15 to 30 mΩ)	2012/0805	0.9 to 1.1	3.2 to 3.8	1.1 to 1.4
ERJ8BW	3216/1206	1.2	4.4 to 5.0	1.3 to 1.8
ERJ8CW (10 to 16 mΩ)				
ERJ8CW (18 to 50 mΩ)	3216/1206	2.0 to 2.6	4.4 to 5.0	1.2 to 1.8

* ERJL1W

- An example of a land pattern for High Power Chip Resistors / Wide Terminal Type is shown below.

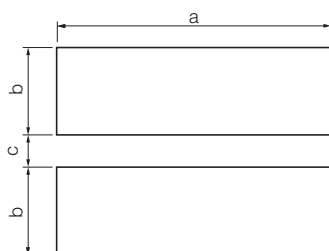

Part No.	Dimensions (mm)		
	a	b	c
ERJA1	6.4	1.70	0.60
ERJB1 ERJC1 ⁽¹⁾ ERJD1 ⁽²⁾	5.0	1.30	0.75
ERJB2 ERJD2 ⁽²⁾	3.2	0.95	0.70
ERJB3	2.0	0.80	0.60

- Anti-Sulfurated High Power Chip Resistors / Wide Terminal Type
- Low TCR High Power Chip Resistors / Wide Terminal Type

● An example of a land pattern for Chip Resistor Array, Anti-Sulfurated Chip Resistor Array and Chip Attenuator is shown below.

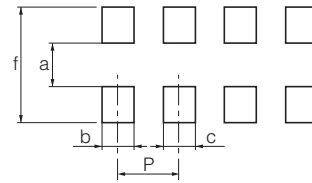
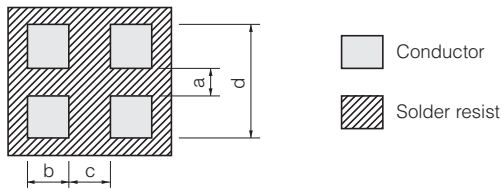

Part No.	Dimensions (mm)			
	a	b	c	d
EXB14V EXB14A	0.30	0.30	0.30	0.80 to 0.90
EXB24V EXBU24 EXB24A	0.5	0.35 to 0.40	0.30	1.4 to 1.5

Part No.	Dimensions (mm)				
	a	b	c	f	P
EXB18V	0.20 to 0.30	0.15 to 0.20	0.15 to 0.20	0.80 to 0.90	0.40
EXBV4V,V8V	0.7 to 0.9	0.4 to 0.45	0.4 to 0.45	2 to 2.4	0.80
EXB34V,38V EXBU34,U38	0.7 to 0.9	0.4 to 0.5	0.4 to 0.5	2.2 to 2.6	0.80
EXBS8V	1 to 1.2	0.5 to 0.75	0.5 to 0.75	3.2 to 3.8	1.27

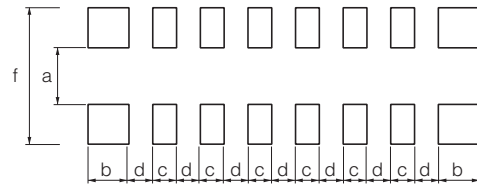
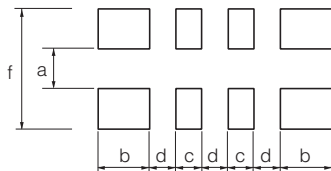

Part No.	Dimensions (mm)				
	a	b	c	d	f
EXB28V EXBU28	0.40	0.525	0.25	0.25	1.40
EXBN8V	0.45 to 0.50	0.35 to 0.38	0.25	0.25	1.40 to 2.00

Part No.	Dimensions (mm)				
	a	b	c	d	f
EXB2HV EXBU2H	1.00	0.425	0.25	0.25	2.00

● An example of a land pattern for Chip Resistor Networks is shown below.

	EXBA	EXBE
For popular pattern	Pitch 1.27 mm 	Pitch 0.8 mm
For high density pattern*	Pitch 0.635 mm Through-hole less EXBA10P, EXBA10E 	Pitch 0.4 mm Through-hole less
For popular pattern	Pitch 0.635 mm 	Pitch 0.5 mm

* When designing high density land patterns, examine the reliability of isolation among the lines and adopt the chip resistor networks.

Recommended Soldering Conditions

Recommendations and precautions are described below.

● Rectangular Type

● Recommended soldering conditions for reflow

- Reflow soldering shall be performed a maximum of two times.
- Please contact us for additional information when used in conditions other than those specified.
- Please measure the temperature of the terminals and study every kind of solder and printed circuit board for solderability before actual use.

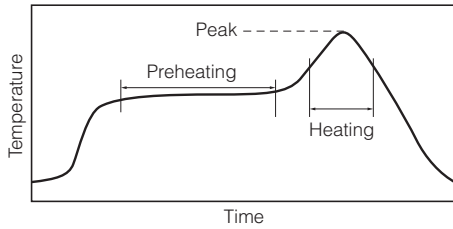

For soldering (Example : Sn/Pb)

	Temperature	Time
Preheating	140 °C to 160 °C	60 s to 120 s
Main heating	Above 200 °C	30 s to 40 s
Peak	235 ± 5 °C	max. 10 s

For lead-free soldering (Example : Sn/Ag/Cu)

	Temperature	Time
Preheating	150 °C to 180 °C	60 s to 120 s
Main heating	Above 230 °C	30 s to 40 s
Peak	max. 260 °C	max. 10 s

● Recommended soldering conditions for flow

	For soldering		For lead-free soldering	
	Temperature	Time	Temperature	Time
Preheating	140 °C to 180 °C	60 s to 120 s	150 °C to 180 °C	60 s to 120 s
Soldering	245 ± 5 °C	20 s to 30 s	max. 260 °C	max. 10 s

● Chip Resistor Array, Chip Resistor Networks and Chip Attenuator

● Recommended soldering conditions for reflow

- Reflow soldering shall be performed a maximum of two times.
- Please contact us for additional information when used in conditions other than those specified.
- Please measure the temperature of the terminals and study every kind of solder and printed circuit board for solderability before actual use.

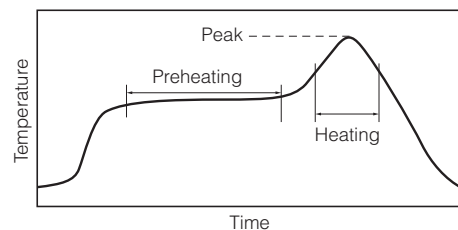

For soldering (Example : Sn/Pb)

	Temperature	Time
Preheating	140 °C to 160 °C	60 s to 120 s
Main heating	Above 200 °C	30 s to 40 s
Peak	235 ± 5 °C	max. 10 s

For lead-free soldering (Example : Sn/Ag/Cu)

	Temperature	Time
Preheating	150 °C to 180 °C	60 s to 120 s
Main heating	Above 230 °C	30 s to 40 s
Peak	max. 260 °C	max. 10 s

● Flow soldering

We do not recommend flow soldering, because a solder bridge may form. Please contact us regarding flow soldering of EXBA series.

Standard for Resistance Value and Resistance Tolerance

Basis Standard

IEC Publication 60062 : Marking codes for resistors and capacitors.
 IEC Publication 60063 : Preferred number series for resistors and capacitors.
 JIS C 5062 : Marking codes for resistors and capacitors.
 JIS C 5063 : Preferred number series for resistors and capacitors.

Resistance Values

The resistance values are notched by "Ratio" below in each series.

Series	Resistance Tolerance (Standard)	Ratio	Remarks
E6	±20 %	$\sqrt[6]{10} \approx 1.46$	Please refer to standard resistance values shown on this catalog.
E12	±10 %	$\sqrt[12]{10} \approx 1.21$	
E24	± 5 %	$\sqrt[24]{10} \approx 1.10$	
E48	± 2 %	$\sqrt[48]{10} \approx 1.05$	
E96	± 1 %	$\sqrt[96]{10} \approx 1.02$	

How to express the resistance value with a Panasonic part number

The resistance value expressed in ohms is identified by a three digit number or a four digit number.
 The last digit specifies the number of zeroes to follow.
 The letter "R" shall be used as the decimal point for less than 10 Ω.

The examples of a three digit number

Resistance Code	Value in ohms
R56	0.56
5R6	5.6
100	10
271	270
102	1 k
273	27 k
104	100 k
275	2.7 M
106	10 M
107	100 M

The examples of a four digit number

Resistance Code	Value in ohms
R562	0.562
5R62	5.62
56R2	56.2
1000	100
2711	2.71 k
1002	10 k
2713	271 k
1004	1 M
2715	27.1 M
1006	100 M

How to express the resistance tolerance with a Panasonic part number

The resistance tolerance is identified by a single letter in accordance with the following table and the code is placed just before the resistance code in the following examples.

Tolerance Code	Tolerance (%)	Examples
W	±0.05	W1001 : 1000 Ω±0.05 %
B	±0.1	B1001 : 1000 Ω±0.1 %
C	±0.25	C1001 : 1000 Ω±0.25 %
D	±0.5	D1001 : 1000 Ω±0.5 %
F	±1	F1001 : 1000 Ω±1 %
G	±2	G1001 : 1000 Ω±2 %
J	±5	J101 : 100 Ω±5 %
K	±10	K101 : 100 Ω±10 %
M	±20	M101 : 100 Ω±20 %

Standard Resistance Values

E6	E12	E24	E48	E96	E6	E12	E24	E48	E96	E6	E12	E24	E48	E96
10	10	10	100	100				215	215				464	464
			102		22	22	22		221					475
			105	105				226	226				487	487
			107						232					499
		11	110	110				237	237			51	511	511
			113				24		243					523
			115	115				249	249				536	536
			118						255					549
	12	12	121	121				261	261		56	56	562	562
			124						267					576
			127	127		27	27	274	274				590	590
		13	130						280					604
			133	133				287	287			62	619	619
			137						294					634
			140	140			30	301	301				649	649
			143						309					665
			147	147				316	316		68	68	681	681
			150						324					698
15	15	15	154	154	33	33	33	332	332				715	715
			158						340					732
		16	162	162				348	348			75	750	750
			165						357					768
			169	169			36	365	365				787	787
			174						374					806
			178	178				383	383		82	82	825	825
	18	18	182			39	39		392					845
			187	187				402	402				866	866
			191						412					887
			196	196				422	422			91	909	909
		20	200				43		432					931
			205	205				442	442				953	953
			210						453					976

Design and specifications are each subject to change without notice. Ask factory for the current technical specifications before purchase and/or use.
Should a safety concern arise regarding this product, please be sure to contact us immediately.

Guidelines and precautions regarding the technical information and use of our products described in this online catalog.

- If you want to use our products described in this online catalog for applications requiring special qualities or reliability, or for applications where the failure or malfunction of the products may directly jeopardize human life or potentially cause personal injury (e.g. aircraft and aerospace equipment, traffic and transportation equipment, combustion equipment, medical equipment, accident prevention, anti-crime equipment, and/or safety equipment), it is necessary to verify whether the specifications of our products fit to such applications. Please ensure that you will ask and check with our inquiry desk as to whether the specifications of our products fit to such applications use before you use our products.
- The quality and performance of our products as described in this online catalog only apply to our products when used in isolation. Therefore, please ensure you evaluate and verify our products under the specific circumstances in which our products are assembled in your own products and in which our products will actually be used.
- If you use our products in equipment that requires a high degree of reliability, regardless of the application, it is recommended that you set up protection circuits and redundancy circuits in order to ensure safety of your equipment.
- The products and product specifications described in this online catalog are subject to change for improvement without prior notice. Therefore, please be sure to request and confirm the latest product specifications which explain the specifications of our products in detail, before you finalize the design of your applications, purchase, or use our products.
- The technical information in this online catalog provides examples of our products' typical operations and application circuits. We do not guarantee the non-infringement of third party's intellectual property rights and we do not grant any license, right, or interest in our intellectual property.
- If any of our products, product specifications and/or technical information in this online catalog is to be exported or provided to non-residents, the laws and regulations of the exporting country, especially with regard to security and export control, shall be observed.

<Regarding the Certificate of Compliance with the EU RoHS Directive/REACH Regulations>

- The switchover date for compliance with the RoHS Directive/REACH Regulations varies depending on the part number or series of our products.
- When you use the inventory of our products for which it is unclear whether those products are compliant with the RoHS Directive/REACH Regulation, please select "Sales Inquiry" in the website inquiry form and contact us.

We do not take any responsibility for the use of our products outside the scope of the specifications, descriptions, guidelines and precautions described in this online catalog.

CAUTION AND WARNING

1. The electronic components contained in this catalog are designed and produced for use in home electric appliances, office equipment, information equipment, communications equipment, and other general purpose electronic devices.
Before use of any of these components for equipment that requires a high degree of safety, such as medical instruments, aerospace equipment, disaster-prevention equipment, security equipment, vehicles (automobile, train, vessel), please be sure to contact our sales representative.
2. When applying one of these components for equipment requiring a high degree of safety, no matter what sort of application it might be, be sure to install a protective circuit or redundancy arrangement to enhance the safety of your equipment. In addition, please carry out the safety test on your own responsibility.
3. When using our products, no matter what sort of equipment they might be used for, be sure to make a written agreement on the specifications with us in advance.
4. Technical information contained in this catalog is intended to convey examples of typical performances and/or applications and is not intended to make any warranty with respect to the intellectual property rights or any other related rights of our company or any third parties nor grant any license under such rights.
5. In order to export products in this catalog, the exporter may be subject to the export license requirement under the Foreign Exchange and Foreign Trade Law of Japan.
6. No ozone-depleting substances (ODSs) under the Montreal Protocol are used in the manufacturing processes of Industrial Solutions Company, Panasonic Corporation.
7. The information contained on this material may not be reprinted or reproduced whether wholly or in part, without the prior written permission of Panasonic Corporation.

Safety Precautions

- When using our products, no matter what sort of equipment they might be used for, be sure to confirm the applications and environmental conditions with our specifications in advance.

● Please contact _____



● Factory _____

Device Solutions Business Division
Industrial Solutions Company
Panasonic Corporation
1006 Kadoma, Kadoma City, Osaka 571-8506,
JAPAN





The information in this catalog is valid as of June, 2019.

Looking for pricing, stock, or lifecycle information?

Click below to explore more details on WIN SOURCE:

-  [View ERJ-PB3D3741V on WIN SOURCE](#)
-  [Panasonic Information](#)

Optimize Your Supply Chain with WIN SOURCE Solutions

-  Global Sourcing Solution
-  Obsolete Management
-  Cost Control Management
-  Shortage Management
-  Alternative Solution
-  Excess Inventory Management