



**THE DATASHEET OF
V23054D1026F104**



Cradle S Relay V23054/V23062

- Strong magnet system and wide voltage range
- Highly reliable
- Contacts for signal loads and currents up to 5A
- DC coils operating voltage 6VDC to 220VDC; AC, latching and non-latching coils on request
- Multi purpose relay
- Great variety of contact arrangements and materials to meet specific applications
- Sockets for easy and quick mounting of relays

Typical applications

Press controls with high safety requirements (forcibly guided springs), traffic and railroad signalling, motor vehicle traffic controls, power plants and nuclear power plants controls

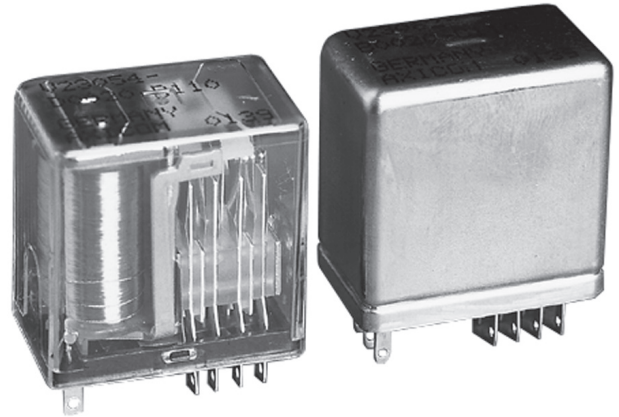

Contact Data

| Product code block 3 | B104/B110/ B112/B133 | B604/B610/ B612/B633 | C104/C110/ C112/C133 | C404/C410/ C422/C433 | F104/F105/ F110 |
|--|--|---------------------------|---------------------------|---------------------------|---------------------------|
| Contact arrangement | max. 6 form C (6 CO) contacts or 6 form A (6 NO) contacts (see product code table) | | | | |
| Max. switching voltage | 150VDC 125VAC | 36VDC 30VAC | 150VDC 125VAC | 36VDC 30VAC | 260VDC 250VAC |
| Rated current | 2A | 0.2A | 2A | 0.2A | 5A |
| Limiting continuous current at max. ambient temperature | 2A | 2A | 2A | 2A | 5A |
| Breaking capacity max. see DC load breaking capacity curve below | 35 to 70W 50VA | 5W, 5VA - | 35 to 70W 50VA | 5W, 5VA - | 50 to 140W 500VA |
| Contact material | silver, gold-flashed | gold F | silver, gold-flashed | gold F | silver, gold-flashed |
| Contact style | single contact | single contact | bifurcated contacts | bifurcated contacts | single contact |
| Frequency of operation, without load, max. | 50 ops./s | max. 50 ops./s | max. 50 ops./s | max. 50 ops./s | max. 10 ops./s |
| Operate / release time typ. | 16/2ms | 16/2ms | 16/2ms | 16/2ms | 16/2ms |
| Mechanical endurance | app. 10 ⁷ ops. | app. 10 ⁷ ops. | app. 10 ⁷ ops. | app. 10 ⁷ ops. | app. 10 ⁷ ops. |

Max. DC breaking capacity, contact sets B1xx, C1xx

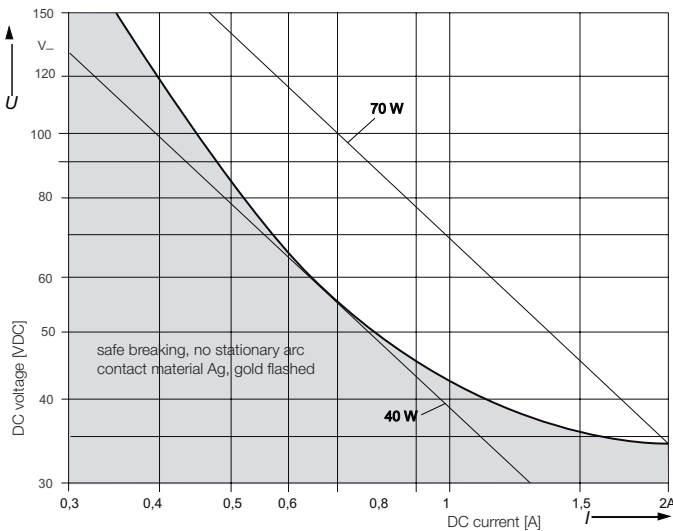

Max. DC breaking capacity, contact sets F1xx

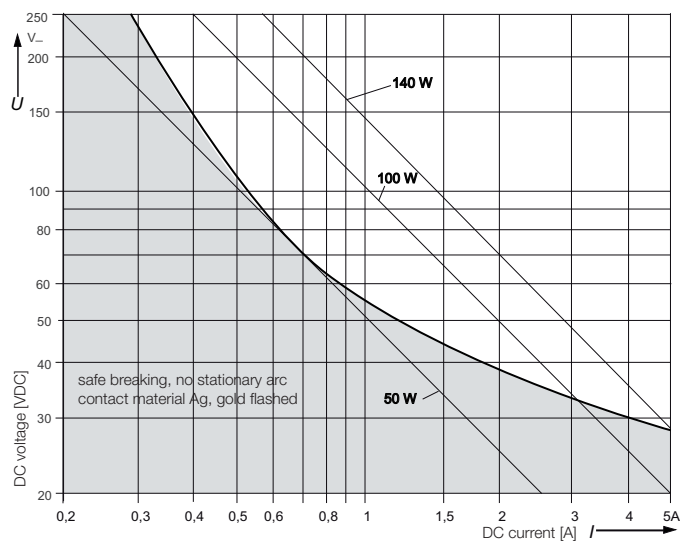

Cradle S Relay V23054/V23062 (Continued)

| Coil Data | |
|-----------------------|--|
| Magnetic system | neutral |
| Coil voltage range | 6 to 220 VDC, 1000 - 2000mW power consumption |
| Max. coil temperature | 100 °C |
| Thermal resistance | < 40K/W |

Coil versions, DC coil, monostable

| Coil code | Rated voltage VDC | Operate/Limiting voltage ¹⁾ VDC | Coil resistance $\Omega \pm 10\%$ | Rated coil power mW |
|-----------|-------------------|--|-----------------------------------|---------------------|
| 011 | 6 | - | 33 | 1091 |
| 012 | 8.4 | - | 70 | 1008 |
| 015 | 12 | - | 130 | 1108 |
| 016 | 12.5 | - | 185 | 845 |
| 017 | 16 | - | 270 | 948 |
| 019 | 20 | - | 390 | 1026 |
| 020 | 24 | - | 630 | 914 |
| 002 | 1.2 | - | 1.75 | 823 |
| 025 | 28 | - | 800 | 980 |
| 046 | 29 | - | 890 | 945 |
| 021 | 32 | - | 1050 | 975 |
| 022 | 45 | - | 1900 | 1066 |
| 026 | 60 | - | 3800 | 947 |
| 014 | 76 | - | 5800 | 996 |
| 004 | 110 | - | 9200 | 1315 |
| 013 | 125 | - | 15500 | 1008 |
| 003 | 220 | - | 25000 | 1936 |

1) See part code table.

All figures are given for coil without pre-energization, at ambient temperature +23°C.

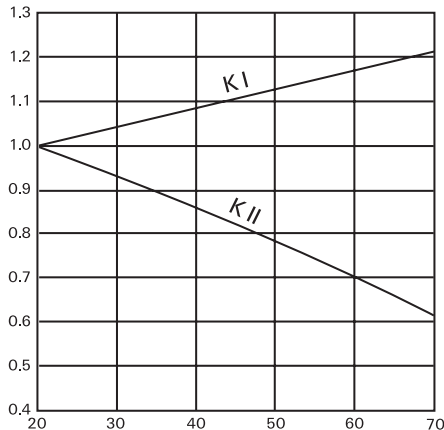

Terminals:

coil with 1 winding: start 4, end 1

coil with 2 windings (upon request):

start 3, end 2 for winding I, start 4, end 1 for winding II

The minimum voltage U_I depends on the contact set and the ambient temperature, the maximum voltage U_{II} only depends on the ambient temperature.

Between minimum voltage $U_{I \text{ tamb}}$ and operating voltage U a safety margin of approx. 20% is recommended.

$$U_{I \text{ tamb}} (1.2) < U \leq U_{II \text{ tamb}}$$

$$U_{I \text{ tamb}} = U_I \cdot U_{20 \text{ °C}} \cdot k_{I \text{ tamb}}$$

$$U_{II \text{ tamb}} = U_{II \text{ 20 °C}} \cdot k_{II \text{ tamb}}$$

tamb Ambient temperature

U Operating voltage

$U_{I \text{ tamb}}$ Minimum voltage at ambient temperature, tamb

$U_{II \text{ tamb}}$ Maximum voltage at ambient temperature, tamb

k_I and k_{II} Factors

| Insulation Data | B1xx, B6xx, C1xx, C4xx | F1xx |
|--|------------------------|----------------------|
| Initial surge withstand voltage | | |
| between open contacts | 500V _{rms} | 500V _{rms} |
| between contact and coil | 500V _{rms} | 1000V _{rms} |
| between adjacent contacts | 500V _{rms} | 1000V _{rms} |
| Initial insulation resistance, at 500VDC | > 10 ⁶ Ω | |

Other Data

Material compliance: EU RoHS/ELV, China RoHS, REACH, Halogen content refer to the Product Compliance Support Center at www.te.com/customer-support/rohssupportcenter

Ambient temperature -40 to +70°C

Category of environmental protection

IEC 61810

RT I - dust protected,

RT V - hermetically sealed

Degree of protection, IEC 60529

dust-protected IP 30,

or hermetically sealed IP 67

Terminal type

PCB, solder terminals

Weight

V23054 Size I

approx. 20g

V23054 Size II

approx. 25g

V23054 Size III

approx. 27g

V23062 Size I

approx. 30g

V23062 Size II

approx. 35g

Washing

not recommended

Ultrasonic cleaning

not recommended

Packaging unit

5 pcs.

Accessories

For details see datasheet

Cradle Relay, Accessories and Mounting

Cradle S Relay V23054/V23062 (Continued)

Terminal assignment

Size I

2 form C (2 CO)
V230xx-xxxxx-Bx04
V230xx-xxxxx-Cx04

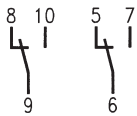

2 form A (2 NO)
V230xx-xxxxx-F105



Size II

6 form A (6 NO)
V230xx-xxxxx-Bx12
V230xx-xxxxx-Cx12

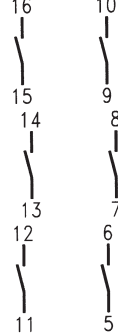

4 form C (4 CO)
V230xx-xxxxx-Bx10
V230xx-xxxxx-Cx10

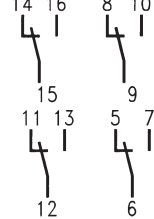

2 form C (2 CO)
V230xx-xxxxx-F104

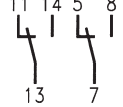

Size III

6 form C (6 CO)
V230xx-xxxxx-Bx33
V230xx-xxxxx-Cx33

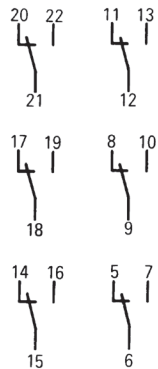

4 form C (4 CO)
V230xx-xxxxx-F110

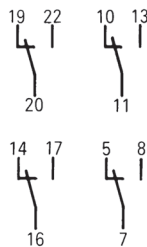

Dimensions

V23054-Cxxx, size I type

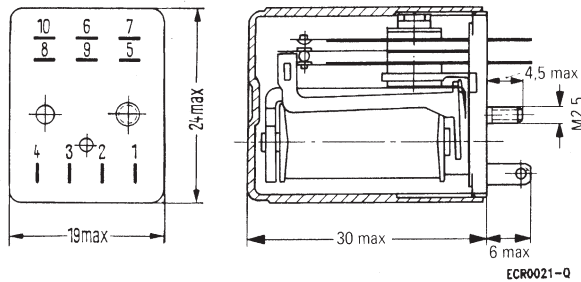

V23054-Dxxx, size II type

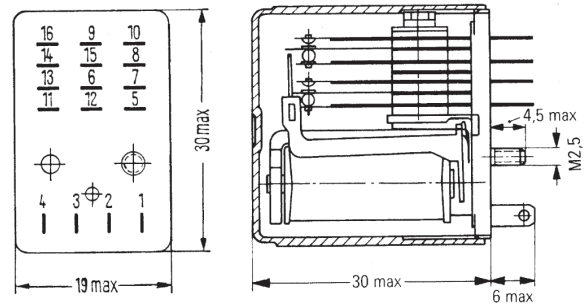

V23054-Exxx, size I type

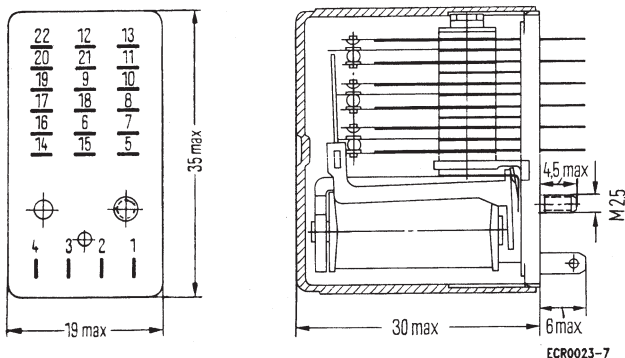

Cradle S Relay V23054/V23062 (Continued)

Dimensions

V23062-Axxx, size I type

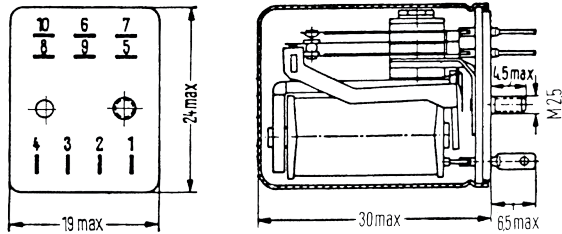

V23062-Bxxx, size II type

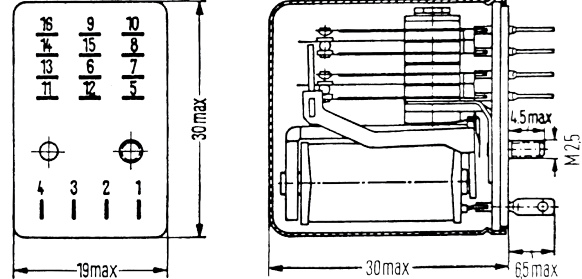

Instructions for Impulse Operation

The maximum voltage stated in the part code table can be increased for impulse operation as follows:

$$U_{II \text{ Impuls}} = U_{II \text{ tamb}} \times q$$

$U_{II \text{ tamb}}$ Maximum continuous voltage at ambient temperature t_{amb}
 q Factor

The impulse voltage must not exceed 80% of the test voltage (winding/frame or winding/winding) or 2.5 times the value of the maximum voltage listed in the part code table.

If $t_{ED} \leq 3s$ then $q = \sqrt{\frac{t_2}{t_{ED}}}$; If $t_{ED} =$ Pulse width, $t_2 =$ Cycle time. If $t_{ED} > 3s$ the value of q must be obtained from the nomograph.

Examples of various periodic pulse trains (energizing side)

1. Periodic recurrence of one energizing pulse



2. Periodic recurrence of two unequal energizing pulses

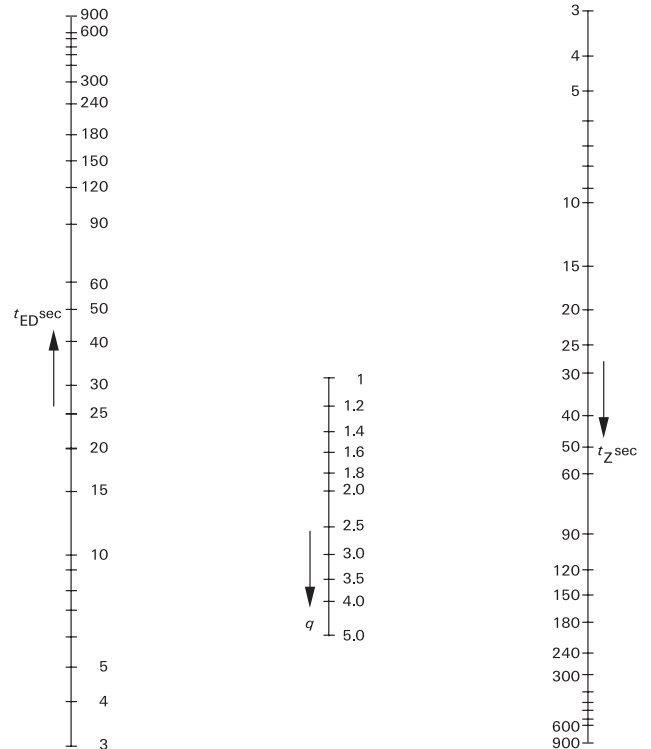
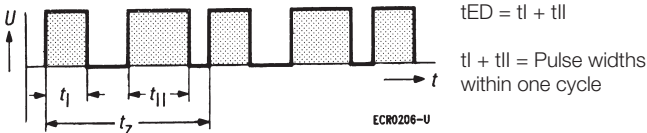

Cradle S Relay V23054/V23062 (Continued)

| | | | | | | | | |
|-------------------------------|--|--|---------------------|----------------|-----------------|------------|----------------|-----------|
| Product code structure | | Typical product code | V23054 | -D | 0 | 021 | -B1 | 10 |
| Type | | | | | | | | |
| V23054 | Cradle S Relay, dust protected | | | | | | | |
| V23062 | Cradle S Relay, hermetically sealed | | | | | | | |
| Size | | | | | | | | |
| V23054 types | | | | | | | | |
| C | Size I, dust-protected | | | | | | | |
| D | Size II, dust-protected | | | | | | | |
| E | Size III, dust-protected | | | | | | | |
| V23062 types | | | | | | | | |
| A | Size I, hermetically sealed | | | | | | | |
| B | Size II, hermetically sealed | | | | | | | |
| Version | | | | | | | | |
| 0 | Standard version | | | | | | | |
| 1 | Fitted with contact pile-ups F | | | | | | | |
| 2 | For higher test voltage of 2kV coil/frame | | | | | | | |
| 3 | Combination of 1 & 2 (contact pile-ups F and higher test voltage coil/frame) | | | | | | | |
| Coils | | Coil code: please refer to coil versions table | | | | | | |
| Contact style | | | | | | | | |
| B1 | Single contacts | B6 | Single contacts | F1 | Single contacts | | | |
| C1 | Bifurcated contacts | C4 | Bifurcated contacts | | | | | |
| Contact arrangement | | | | | | | | |
| 04 | 2 form C, 2 CO | | 05 | 2 form A, 1 NO | | | | |
| 10 | 4 form C, 4 CO | | 12 | 6 form A, 6 NO | | 33 | 6 form C, 6 CO | |

Other types on request

| Product code | Version | Coil | Operate/Lim. | Arrangement | Contacts | Enclosure | PartNumber |
|---------------------------------------|------------------|---------|--------------|----------------|------------|----------------|-------------|
| V23054-CXXXX, standard, size I | | | | | | | |
| V23054-C0013-B104 | Standard, size I | 125VDC | 59/190VDC | 2 form C, 2 CO | Single | Dust protected | 2-1419172-8 |
| V23054-C0015-B104 | Standard, size I | 12VDC | 4.7/18VDC | 2 form C, 2 CO | Single | Dust protected | 1393812-6 |
| V23054-C0016-B104 | Standard, size I | 12.5VDC | 5.4/21.5VDC | 2 form C, 2 CO | Single | Dust protected | 1393812-7 |
| V23054-C0019-C104 | Standard, size I | 20VDC | 10.5/31VDC | 2 form C, 2 CO | Bifurcated | Dust protected | 1422019-3 |
| V23054-C2003-C404 | Standard, size I | 220VDC | 98/240VDC | 2 form C, 2 CO | Bifurcated | Dust protected | 3-1393812-2 |
| V23054-C2004-B104 | Standard, size I | 110VDC | 44/145VDC | 2 form C, 2 CO | Single | Dust protected | 3-1393812-3 |
| V23054-C2013-B104 | Standard, size I | 125VDC | 59/190VDC | 2 form C, 2 CO | Single | Dust protected | 3-1393812-4 |
| V23054-C2020-B104 | Standard, size I | 24VDC | 10.5/39VDC | 2 form C, 2 CO | Single | Dust protected | 3-1393812-5 |
| V23054-C2026-C104 | Standard, size I | 60VDC | 36/94VDC | 2 form C, 2 CO | Bifurcated | Dust protected | 3-1393812-6 |
| V23054-C0020-B104 | Standard, size I | 24VDC | 10.5/39VDC | 2 form C, 2 CO | Single | Dust protected | 1-1393812-0 |
| V23054-C0020-C104 | Standard, size I | 24VDC | 13/39VDC | 2 form C, 2 CO | Bifurcated | Dust protected | 1-1393812-1 |
| V23054-C0021-B104 | Standard, size I | 32VDC | 14.5/50VDC | 2 form C, 2 CO | Single | Dust protected | 1-1393812-2 |
| V23054-C0021-C104 | Standard, size I | 32VDC | 17.5/50VDC | 2 form C, 2 CO | Bifurcated | Dust protected | 1-1393812-3 |
| V23054-C0021-C404 | Standard, size I | 32VDC | 17.5/50VDC | 2 form C, 2 CO | Bifurcated | Dust protected | 1-1393812-4 |
| V23054-C0022-B104 | Standard, size I | 45VDC | 19/66VDC | 2 form C, 2 CO | Single | Dust protected | 1-1393812-5 |
| V23054-C0022-C104 | Standard, size I | 45VDC | 24/66VDC | 2 form C, 2 CO | Bifurcated | Dust protected | 1-1393812-6 |
| V23054-C0026-B104 | Standard, size I | 60VDC | 29/94VDC | 2 form C, 2 CO | Single | Dust protected | 2-1393812-0 |
| V23054-C0026-C104 | Standard, size I | 60VDC | 36/94VDC | 2 form C, 2 CO | Bifurcated | Dust protected | 2-1393812-3 |
| V23054-C0026-C404 | Standard, size I | 60VDC | 36/94VDC | 2 form C, 2 CO | Bifurcated | Dust protected | 2-1393812-4 |
| V23054-C003-B104 | Standard, size I | 220VDC | 79/240VDC | 2 form C, 2 CO | Single | Dust protected | 1393812-2 |
| V23054-C003-C104 | Standard, size I | 220VDC | 98/240VDC | 2 form C, 2 CO | Bifurcated | Dust protected | 1393812-3 |
| V23054-C004-B104 | Standard, size I | 110VDC | 44/145VDC | 2 form C, 2 CO | Single | Dust protected | 1393812-4 |
| V23054-C004-C104 | Standard, size I | 110VDC | 53.5/145VDC | 2 form C, 2 CO | Bifurcated | Dust protected | 1393812-5 |
| V23054-CXXXX, 5A, size I | | | | | | | |
| V23054-C1022-F105 | 5A, size I | 45VDC | 19/66VDC | 2 form A, 2 NO | Single | Dust protected | 3-1393812-1 |
| V23054-C3015-F105 | 5A, size I | 12VDC | 4.7/18VDC | 2 form A, 2 NO | Single | Dust protected | 1422019-5 |

Cradle S Relay V23054/V23062 (Continued)



| Product code | Version | Coil | Operate/Lim. | Arrangement | Contacts | Enclosure | PartNumber |
|---|--------------------|---------|--------------|----------------|------------|----------------|-------------|
| V23054-DXXXX, standard, size II | | | | | | | |
| V23054-D0013-B110 | Standard, size II | 125VDC | 59/190VDC | 4 form C, 4 CO | Single | Dust protected | 4-1419172-5 |
| V23054-D0015-B112 | Standard, size II | 12VDC | 4.7/18VDC | 6 form A, 6 NO | Single | Dust protected | 6-1422019-5 |
| V23054-D0016-C110 | Standard, size II | 12.5VDC | 5.4/21.5VDC | 4 form C, 4 CO | Bifurcated | Dust protected | 4-1393812-2 |
| V23054-D0017-B110 | Standard, size II | 16VDC | 7/25.5VDC | 4 form C, 4 CO | Single | Dust protected | 4-1393812-3 |
| V23054-D0017-B110 | Standard, size II | 16VDC | 7/25.5VDC | 4 form C, 4 CO | Single | Dust protected | 4-1393812-4 |
| V23054-D0019-B110 | Standard, size II | 20VDC | 10.5/31VDC | 4 form C, 4 CO | Single | Dust protected | 4-1393812-6 |
| V23054-D0019-C110 | Standard, size II | 20VDC | 10.5/31VDC | 4 form C, 4 CO | Bifurcated | Dust protected | 4-1393812-7 |
| V23054-D0019-C410 | Standard, size II | 20VDC | 10.5/31VDC | 4 form C, 4 CO | Bifurcated | Dust protected | 5-1393812-0 |
| V23054-D2003-B110 | Standard, size II | 220VDC | 79/240VDC | 4 form C, 4 CO | Single | Dust protected | 1393813-1 |
| V23054-D2013-B110 | Standard, size II | 125VDC | 59/190VDC | 4 form C, 4 CO | Single | Dust protected | 1393813-2 |
| V23054-D2020-B110 | Standard, size II | 24VDC | 10.5/39VDC | 4 form C, 4 CO | Single | Dust protected | 1393813-3 |
| V23054-D2021-B110 | Standard, size II | 32VDC | 14.5/50VDC | 4 form C, 4 CO | Single | Dust protected | 1393813-4 |
| V23054-D2021-B112 | Standard, size II | 32VDC | 14.5/50VDC | 6 form A, 6 NO | Single | Dust protected | 1393813-5 |
| V23054-D2026-B110 | Standard, size II | 60VDC | 29/94VDC | 4 form C, 4 CO | Single | Dust protected | 1393813-6 |
| V23054-D2026-B112 | Standard, size II | 60VDC | 29/94VDC | 6 form A, 6 NO | Single | Dust protected | 1393813-7 |
| V23054-D0020-B110 | Standard, size II | 24VDC | 10.5/39VDC | 4 form C, 4 CO | Single | Dust protected | 5-1393812-1 |
| V23054-D0020-B112 | Standard, size II | 24VDC | 10.5/39VDC | 6 form A, 6 NO | Single | Dust protected | 5-1393812-2 |
| V23054-D0020-C110 | Standard, size II | 24VDC | 13/39VDC | 4 form C, 4 CO | Bifurcated | Dust protected | 5-1393812-3 |
| V23054-D0002-C410 | Standard, size II | 1.2VDC | 0.75/2.1VDC | 4 form C, 4 CO | Bifurcated | Dust protected | 3-1419137-7 |
| V23054-D0021-B110 | Standard, size II | 32VDC | 14.5/50VDC | 4 form C, 4 CO | Single | Dust protected | 5-1393812-4 |
| V23054-D0021-C112 | Standard, size II | 32VDC | 17.5/50VDC | 6 form A, 6 NO | Bifurcated | Dust protected | 5-1393812-5 |
| V23054-D0022-B110 | Standard, size II | 45VDC | 19/66VDC | 4 form C, 4 CO | Single | Dust protected | 5-1393812-8 |
| V23054-D0022-C110 | Standard, size II | 45VDC | 24/66VDC | 4 form C, 4 CO | Bifurcated | Dust protected | 5-1393812-9 |
| V23054-D0002-B110 | Standard, size II | 1.2VDC | 0.54/2.1VDC | 4 form C, 4 CO | Single | Dust protected | 6-1393812-2 |
| V23054-D0026-B112 | Standard, size II | 60VDC | 29/94VDC | 6 form A, 6 NO | Single | Dust protected | 6-1393812-3 |
| V23054-D0026-C110 | Standard, size II | 60VDC | 43/94VDC | 4 form C, 4 CO | Bifurcated | Dust protected | 6-1393812-4 |
| V23054-D0026-C112 | Standard, size II | 60VDC | 36/94VDC | 6 form A, 6 NO | Bifurcated | Dust protected | 6-1393812-5 |
| V23054-D0026-C114 | Standard, size II | 60VDC | 29/94VDC | 4 form A, 4 NO | Bifurcated | Dust protected | 6-1393812-6 |
| V23054-D003-B110 | Standard, size II | 220VDC | 79/240VDC | 4 form C, 4 CO | Single | Dust protected | 3-1393812-8 |
| V23054-D004-C110 | Standard, size II | 110VDC | 44/145VDC | 4 form C, 4 CO | Bifurcated | Dust protected | 3-1393812-9 |
| V23054-DXXXX, 5A, size II | | | | | | | |
| V23054-D1003-F104 | 5A, size II | 220VDC | 98/240VDC | 2 form C, 2 CO | Single | Dust protected | 8-1393812-6 |
| V23054-D1004-F104 | 5A, size II | 110VDC | 53.5/145VDC | 2 form C, 2 CO | Single | Dust protected | 8-1393812-7 |
| V23054-D1011-F104 | 5A, size II | 6VDC | 2.9/9VDC | 2 form C, 2 CO | Single | Dust protected | 8-1393812-8 |
| V23054-D1012-F104 | 5A, size II | 8.4VDC | 4.4/13VDC | 2 form C, 2 CO | Single | Dust protected | 8-1393812-9 |
| V23054-D1015-F104 | 5A, size II | 12VDC | 5.8/18VDC | 2 form C, 2 CO | Single | Dust protected | 9-1393812-0 |
| V23054-D1017-F104 | 5A, size II | 16VDC | 8.7/25.5VDC | 2 form C, 2 CO | Single | Dust protected | 9-1393812-1 |
| V23054-D1019-F104 | 5A, size II | 20VDC | 10.5/31VDC | 2 form C, 2 CO | Single | Dust protected | 9-1393812-2 |
| V23054-D1020-F104 | 5A, size II | 24VDC | 13/39VDC | 2 form C, 2 CO | Single | Dust protected | 9-1393812-3 |
| V23054-D1021-F104 | 5A, size II | 32VDC | 17.5/50VDC | 2 form C, 2 CO | Single | Dust protected | 9-1393812-4 |
| V23054-D1022-F104 | 5A, size II | 45VDC | 24/66VDC | 2 form C, 2 CO | Single | Dust protected | 9-1393812-5 |
| V23054-D1026-F104 | 5A, size II | 60VDC | 36/94VDC | 2 form C, 2 CO | Single | Dust protected | 9-1393812-8 |
| V23054-D3003-F104 | 5A, size II | 220VDC | 98/240VDC | 2 form C, 2 CO | Single | Dust protected | 1393813-9 |
| V23054-D0300-F104 | 5A, size II | 110VDC | 53.5/145VDC | 2 form C, 2 CO | Single | Dust protected | 1-1393813-1 |
| V23054-D3020-F104 | 5A, size II | 24VDC | 13/39VDC | 2 form C, 2 CO | Single | Dust protected | 1-1393813-4 |
| V23054-D3026-F104 | 5A, size II | 60VDC | 36/94VDC | 2 form C, 2 CO | Single | Dust protected | 1-1393813-6 |
| V23054-EXXXX, standard, size III | | | | | | | |
| V23054-E0012-B133 | Standard, size III | 8.4VDC | 4.4/13VDC | 6 form C, 6 CO | Single | Dust protected | 2-1393813-5 |
| V23054-E0015-B133 | Standard, size III | 12VDC | 5.8/18VDC | 6 form C, 6 CO | Single | Dust protected | 2-1393813-6 |
| V23054-E0015-C133 | Standard, size III | 12VDC | 8.8/18VDC | 6 form C, 6 CO | Bifurcated | Dust protected | 2-1393813-7 |
| V23054-E0016-B133 | Standard, size III | 12.5VDC | 6.9/21.5VDC | 6 form C, 6 CO | Single | Dust protected | 2-1393813-8 |
| V23054-E0016-C133 | Standard, size III | 12.5VDC | 10/21.5VDC | 6 form C, 6 CO | Bifurcated | Dust protected | 3-1393813-0 |
| V23054-E0017-B133 | Standard, size III | 16VDC | 8.7/25.5VDC | 6 form C, 6 CO | Single | Dust protected | 3-1393813-1 |
| V23054-E0017-C133 | Standard, size III | 16VDC | 13/25.5VDC | 6 form C, 6 CO | Bifurcated | Dust protected | 3-1393813-2 |
| V23054-E0019-B133 | Standard, size III | 20VDC | 10.5/31VDC | 6 form C, 6 CO | Single | Dust protected | 3-1393813-3 |
| V23054-E0019-C133 | Standard, size III | 20VDC | 15.5/31VDC | 6 form C, 6 CO | Bifurcated | Dust protected | 3-1393813-4 |
| V23054-E0019-C433 | Standard, size III | 20VDC | 15.5/31VDC | 6 form C, 6 CO | Bifurcated | Dust protected | 3-1393813-5 |
| V23054-E2004-B133 | Standard, size III | 110VDC | 53.5/145VDC | 6 form C, 6 CO | Single | Dust protected | 9-1393813-0 |
| V23054-E2013-B133 | Standard, size III | 125VDC | 73/190VDC | 6 form C, 6 CO | Single | Dust protected | 1422019-2 |
| V23054-E2026-B133 | Standard, size III | 60VDC | 36/94VDC | 6 form C, 6 CO | Single | Dust protected | 9-1393813-4 |
| V23054-E0020-B133 | Standard, size III | 24VDC | 13/39VDC | 6 form C, 6 CO | Single | Dust protected | 3-1393813-6 |
| V23054-E0020-B533 | Standard, size III | 24VDC | 13/39VDC | 6 form C, 6 CO | Single | Dust protected | 3-1393813-9 |
| V23054-E0020-B633 | Standard, size III | 24VDC | 13/39VDC | 6 form C, 6 CO | Single | Dust protected | 4-1393813-0 |
| V23054-E0020-C133 | Standard, size III | 24VDC | 20/39VDC | 6 form C, 6 CO | Bifurcated | Dust protected | 4-1393813-1 |
| V23054-E0020-C433 | Standard, size III | 24VDC | 20/39VDC | 6 form C, 6 CO | Bifurcated | Dust protected | 4-1393813-2 |
| V23054-E0021-B133 | Standard, size III | 32VDC | 17.5/50VDC | 6 form C, 6 CO | Single | Dust protected | 4-1393813-3 |
| V23054-E0022-B133 | Standard, size III | 45VDC | 24/66VDC | 6 form C, 6 CO | Single | Dust protected | 4-1393813-4 |
| V23054-E0022-B633 | Standard, size III | 45VDC | 24/66VDC | 6 form C, 6 CO | Single | Dust protected | 4-1393813-5 |
| V23054-E0022-C133 | Standard, size III | 45VDC | 35/66VDC | 6 form C, 6 CO | Bifurcated | Dust protected | 4-1393813-6 |
| V23054-E0026-B133 | Standard, size III | 60VDC | 36/94VDC | 6 form C, 6 CO | Single | Dust protected | 4-1393813-8 |
| V23054-E0026-C133 | Standard, size III | 60VDC | 55/94VDC | 6 form C, 6 CO | Bifurcated | Dust protected | 4-1393813-9 |

Cradle S Relay V23054/V23062 (Continued)

| Product code | Version | Coil | Operate/Lim. | Arrangement | Contacts | Enclosure | PartNumber |
|--|-------------------|---------|--------------|----------------|------------|----------------|-------------|
| V23054-EXXXX, 5A, size III | | | | | | | |
| V23054-E1003-F110 | 5A, size III | 220VDC | 118/240VDC | 4 form C, 4 CO | Single | Dust protected | 5-1393813-9 |
| V23054-E1004-F110 | 5A, size III | 110VDC | 66/145VDC | 4 form C, 4 CO | Single | Dust protected | 6-1393813-0 |
| V23054-E1011-F110 | 5A, size III | 6VDC | 3.5/9VDC | 4 form C, 4 CO | Single | Dust protected | 6-1393813-1 |
| V23054-E1015-F110 | 5A, size III | 12VDC | 7/18VDC | 4 form C, 4 CO | Single | Dust protected | 6-1393813-3 |
| V23054-E1016-F110 | 5A, size III | 12.5VDC | 8.1/21.5VDC | 4 form C, 4 CO | Single | Dust protected | 6-1393813-6 |
| V23054-E1017-F110 | 5A, size III | 16VDC | 10.5/25.5VDC | 4 form C, 4 CO | Single | Dust protected | 6-1393813-8 |
| V23054-E1019-F110 | 5A, size III | 20VDC | 13/31VDC | 4 form C, 4 CO | Single | Dust protected | 7-1393813-2 |
| V23054-E1020-F110 | 5A, size III | 24VDC | 15.5/39VDC | 4 form C, 4 CO | Single | Dust protected | 7-1393813-6 |
| V23054-E1021-F110 | 5A, size III | 32VDC | 21/50VDC | 4 form C, 4 CO | Single | Dust protected | 8-1393813-1 |
| V23054-E1022-F110 | 5A, size III | 45VDC | 29/66VDC | 4 form C, 4 CO | Single | Dust protected | 8-1393813-2 |
| V23054-E1026-F110 | 5A, size III | 60VDC | 43/94VDC | 4 form C, 4 CO | Single | Dust protected | 8-1393813-5 |
| V23054-E3020-F110 | 5A, size III | 24VDC | 15.5/39VDC | 4 form C, 4 CO | Single | Dust protected | 1-1393814-0 |
| V23062-AXXXX, standard, size I | | | | | | | |
| V23062-A0014-C404 | Standard, size I | 76VDC | 32/110VDC | 2 form C, 2 CO | Bifurcated | Herm. sealed | 1393815-1 |
| V23062-A0025-C104 | Standard, size I | 28VDC | 15/40VDC | 2 form C, 2 CO | Bifurcated | Herm. sealed | 1393815-2 |
| V23062-A0046-C104 | Standard, size I | 29VDC | 13/43VDC | 2 form C, 2 CO | Bifurcated | Herm. sealed | 1393815-3 |
| V23062-BXXXX, standard, size II | | | | | | | |
| V23062-B0019-C410 | Standard, size II | 20VDC | 13/31VDC | 4 form C, 4 CO | Bifurcated | Herm. sealed | 1393815-4 |
| V23062-B0020-C110 | Standard, size II | 24VDC | 15.5/39VDC | 4 form C, 4 CO | Bifurcated | Herm. sealed | 1393815-5 |
| V23062-B0022-C110 | Standard, size II | 45VDC | 29/66VDC | 4 form C, 4 CO | Bifurcated | Herm. sealed | 1393815-7 |
| V23062-B0026-B610 | Standard, size II | 60VDC | 29/94VDC | 4 form C, 4 CO | Single | Herm. sealed | 1393815-8 |
| V23062-BXXXX, 5A, size II | | | | | | | |
| V23062-B1004-F104 | 5A, size II | 110VDC | 53.5/145VDC | 2 form C, 2 CO | Single | Herm. sealed | 1-1393815-1 |
| V23062-B1026-F104 | 5A, size II | 60VDC | 36/94VDC | 2 form C, 2 CO | Single | Herm. sealed | 1-1393815-7 |

Looking for pricing, stock, or lifecycle information?

Click below to explore more details on WIN SOURCE:

-  [View V23054D1026F104 on WIN SOURCE](#)
-  [TE Connectivity Information](#)

Optimize Your Supply Chain with WIN SOURCE Solutions

-  Global Sourcing Solution
-  Obsolete Management
-  Cost Control Management
-  Shortage Management
-  Alternative Solution
-  Excess Inventory Management