



**THE DATASHEET OF
CY7C1361C-133AXCT**



9-Mbit (256K × 36/512K × 18) Flow-Through SRAM

Features

- Supports 100 MHz, 133 MHz bus operations
- Supports 100 MHz bus operations (Automotive)
- 256K × 36/512K × 18 common I/O
- 3.3 V – 5% and +10% core power supply (V_{DD})
- 2.5 V or 3.3 V I/O power supply (V_{DDQ})
- Fast clock-to-output times
 - 6.5 ns (133-MHz version)
- Provide high performance 2-1-1-1 access rate
- User-selectable burst counter supporting Intel® Pentium® interleaved or linear burst sequences
- Separate processor and controller address strobes
- Synchronous self-timed write
- Asynchronous output enable
- Available in Pb-free 100-pin TQFP package, Pb-free 165-ball FBGA package and non Pb-free 119-ball BGA package
- TQFP available with 3-chip enable and 2-chip enable
- IEEE 1149.1 JTAG-compatible boundary scan
- “ZZ” sleep mode option

Functional Description

The CY7C1361C/CY7C1363C is a 3.3 V, 256K × 36/512K × 18 synchronous flow-through SRAMs, respectively designed to interface with high speed microprocessors with minimum glue logic. Maximum access delay from clock rise is 6.5 ns (133 MHz version). A 2-bit on-chip counter captures the first address in a burst and increments the address automatically for the rest of the burst access. All synchronous inputs are gated by registers controlled by a positive-edge-triggered clock input (CLK). The synchronous inputs include all addresses, all data inputs, address-pipelining chip enable (CE_1), depth-expansion chip enables (CE_2 and $CE_3^{(1)}$), burst control inputs (ADSC, ADSP, and ADV), write enables (BW_x , and BWE), and global write (GW). Asynchronous inputs include the output enable (OE) and the ZZ pin.

The CY7C1361C/CY7C1363C enables either interleaved or linear burst sequences, selected by the MODE input pin. A HIGH selects an interleaved burst sequence, while a LOW selects a linear burst sequence. Burst accesses can be initiated with the processor address strobe (ADSP) or the cache controller address strobe (ADSC) inputs. Address advancement is controlled by the address advancement (ADV) input.

Addresses and chip enables are registered at rising edge of clock when either address strobe processor (ADSP) or address strobe controller (ADSC) are active. Subsequent burst addresses can be internally generated as controlled by the advance pin (ADV).

The CY7C1361C/CY7C1363C operates from a +3.3 V core power supply while all outputs may operate with either a +2.5 or +3.3 V supply. All inputs and outputs are JEDEC-standard JESD8-5-compatible.

For a complete list of related documentation, click [here](#).

Selection Guide

Description		133 MHz	100 MHz	Unit
Maximum access time		6.5	8.5	ns
Maximum operating current		250	180	mA
Maximum CMOS standby current	Commercial/Industrial	40	40	mA
	Automotive	–	60	mA

Note

1. CE_3 is for A version of 100-pin TQFP (3 Chip Enable Option). 119-ball BGA is offered only in 2 Chip Enable.

Contents

Pin Configurations	4	Identification Register Definitions	19
Pin Definitions	8	Scan Register Sizes	19
Functional Overview	9	Instruction Codes	19
Single Read Accesses	9	Boundary Scan Order	20
Single Write Accesses Initiated by ADSP	9	Boundary Scan Order	21
Single Write Accesses Initiated by ADSC	10	Maximum Ratings	22
Burst Sequences	10	Operating Range	22
Sleep Mode	10	Neutron Soft Error Immunity	22
Interleaved Burst Address Table	10	Electrical Characteristics	22
Linear Burst Address Table	10	Capacitance	23
ZZ Mode Electrical Characteristics	10	Thermal Resistance	23
Truth Table	11	AC Test Loads and Waveforms	24
Partial Truth Table for Read/Write	12	Switching Characteristics	25
Partial Truth Table for Read/Write	12	Timing Diagrams	26
IEEE 1149.1 Serial Boundary Scan (JTAG)	13	Ordering Information	30
Disabling the JTAG Feature	13	Ordering Code Definitions	30
Test Access Port (TAP)	13	Package Diagrams	31
PERFORMING A TAP RESET	13	Acronyms	33
TAP REGISTERS	13	Document Conventions	33
TAP Instruction Set	14	Units of Measure	33
TAP Controller State Diagram	15	Document History Page	34
TAP Controller Block Diagram	16	Sales, Solutions, and Legal Information	37
TAP Timing	16	Worldwide Sales and Design Support	37
TAP AC Switching Characteristics	17	Products	37
3.3 V TAP AC Test Conditions	17	PSoC® Solutions	37
3.3 V TAP AC Output Load Equivalent	17	Cypress Developer Community	37
2.5 V TAP AC Test Conditions	17	Technical Support	37
2.5 V TAP AC Output Load Equivalent	17		
TAP DC Electrical Characteristics and Operating Conditions	18		

Pin Configurations (continued)

Figure 3. 119-ball BGA (14 × 22 × 2.4 mm) pinout (2 Chip Enables with JTAG)

CY7C1361C (256K × 36)

	1	2	3	4	5	6	7
A	V _{DDQ}	A	A	$\overline{\text{ADSP}}$	A	A	V _{DDQ}
B	NC/288M	CE ₂	A	$\overline{\text{ADSC}}$	A	A	NC/512M
C	NC/144M	A	A	V _{DD}	A	A	NC/1G
D	DQ _C	DQP _C	V _{SS}	NC	V _{SS}	DQP _B	DQ _B
E	DQ _C	DQ _C	V _{SS}	$\overline{\text{CE}}_1$	V _{SS}	DQ _B	DQ _B
F	V _{DDQ}	DQ _C	V _{SS}	$\overline{\text{OE}}$	V _{SS}	DQ _B	V _{DDQ}
G	DQ _C	DQ _C	$\overline{\text{BW}}_C$	$\overline{\text{ADV}}$	$\overline{\text{BW}}_B$	DQ _B	DQ _B
H	DQ _C	DQ _C	V _{SS}	$\overline{\text{GW}}$	V _{SS}	DQ _B	DQ _B
J	V _{DDQ}	V _{DD}	NC	V _{DD}	NC	V _{DD}	V _{DDQ}
K	DQ _D	DQ _D	V _{SS}	CLK	V _{SS}	DQ _A	DQ _A
L	DQ _D	DQ _D	$\overline{\text{BW}}_D$	NC	$\overline{\text{BW}}_A$	DQ _A	DQ _A
M	V _{DDQ}	DQ _D	V _{SS}	$\overline{\text{BWE}}$	V _{SS}	DQ _A	V _{DDQ}
N	DQ _D	DQ _D	V _{SS}	A1	V _{SS}	DQ _A	DQ _A
P	DQ _D	DQP _D	V _{SS}	A0	V _{SS}	DQP _A	DQ _A
R	NC	A	MODE	V _{DD}	NC	A	NC
T	NC	NC/72M	A	A	A	NC/36M	ZZ
U	V _{DDQ}	TMS	TDI	TCK	TDO	NC	V _{DDQ}

Pin Configurations (continued)

Figure 4. 165-ball FBGA pinout (3 Chip Enable)

CY7C1361C (256K × 36)

	1	2	3	4	5	6	7	8	9	10	11
A	NC/288M	A	\overline{CE}_1	\overline{BW}_C	\overline{BW}_B	\overline{CE}_3	\overline{BWE}	\overline{ADSC}	\overline{ADV}	A	NC
B	NC/144M	A	CE_2	\overline{BW}_D	\overline{BW}_A	CLK	\overline{GW}	\overline{OE}	\overline{ADSP}	A	NC/576M
C	DQP _C	NC	V _{DDQ}	V _{SS}	V _{SS}	V _{SS}	V _{SS}	V _{SS}	V _{DDQ}	NC/1G	DQP _B
D	DQ _C	DQ _C	V _{DDQ}	V _{DD}	V _{SS}	V _{SS}	V _{SS}	V _{DD}	V _{DDQ}	DQ _B	DQ _B
E	DQ _C	DQ _C	V _{DDQ}	V _{DD}	V _{SS}	V _{SS}	V _{SS}	V _{DD}	V _{DDQ}	DQ _B	DQ _B
F	DQ _C	DQ _C	V _{DDQ}	V _{DD}	V _{SS}	V _{SS}	V _{SS}	V _{DD}	V _{DDQ}	DQ _B	DQ _B
G	DQ _C	DQ _C	V _{DDQ}	V _{DD}	V _{SS}	V _{SS}	V _{SS}	V _{DD}	V _{DDQ}	DQ _B	DQ _B
H	NC	NC	NC	V _{DD}	V _{SS}	V _{SS}	V _{SS}	V _{DD}	NC	NC	ZZ
J	DQ _D	DQ _D	V _{DDQ}	V _{DD}	V _{SS}	V _{SS}	V _{SS}	V _{DD}	V _{DDQ}	DQ _A	DQ _A
K	DQ _D	DQ _D	V _{DDQ}	V _{DD}	V _{SS}	V _{SS}	V _{SS}	V _{DD}	V _{DDQ}	DQ _A	DQ _A
L	DQ _D	DQ _D	V _{DDQ}	V _{DD}	V _{SS}	V _{SS}	V _{SS}	V _{DD}	V _{DDQ}	DQ _A	DQ _A
M	DQ _D	DQ _D	V _{DDQ}	V _{DD}	V _{SS}	V _{SS}	V _{SS}	V _{DD}	V _{DDQ}	DQ _A	DQ _A
N	DQP _D	NC	V _{DDQ}	V _{SS}	NC	NC/18M	NC	V _{SS}	V _{DDQ}	NC	DQP _A
P	NC	NC/72M	A	A	TDI	A1	TDO	A	A	A	A
R	MODE	NC/36M	A	A	TMS	A0	TCK	A	A	A	A

Pin Definitions

Name	I/O	Description
A ₀ , A ₁ , A	Input-synchronous	Address inputs used to select one of the address locations. Sampled at the rising edge of the CLK if ADSP or ADSC is active LOW, and \overline{CE}_1 , CE ₂ , and CE ₃ ^[2] are sampled active. A _[1:0] feed the 2-bit counter.
$\overline{BW}_A, \overline{BW}_B, \overline{BW}_C, \overline{BW}_D$	Input-synchronous	Byte write select inputs, active LOW. Qualified with \overline{BWE} to conduct byte writes to the SRAM. Sampled on the rising edge of CLK.
\overline{GW}	Input-synchronous	Global write enable input, active LOW. When asserted LOW on the rising edge of CLK, a global write is conducted (all bytes are written, regardless of the values on \overline{BW}_X and \overline{BWE}).
CLK	Input-clock	Clock input. Used to capture all synchronous inputs to the device. Also used to increment the burst counter when \overline{ADV} is asserted LOW, during a burst operation.
\overline{CE}_1	Input-synchronous	Chip enable 1 input, active LOW. Sampled on the rising edge of CLK. Used in conjunction with CE ₂ and CE ₃ ^[2] to select/deselect the device. ADSP is ignored if \overline{CE}_1 is HIGH. \overline{CE}_1 is sampled only when a new external address is loaded.
CE ₂	Input-synchronous	Chip enable 2 input, active HIGH. Sampled on the rising edge of CLK. Used in conjunction with \overline{CE}_1 and CE ₃ ^[2] to select/deselect the device. CE ₂ is sampled only when a new external address is loaded.
CE ₃ ^[2]	Input-synchronous	Chip enable 3 input, active LOW. Sampled on the rising edge of CLK. Used in conjunction with \overline{CE}_1 and CE ₂ to select/deselect the device. CE ₃ is sampled only when a new external address is loaded.
\overline{OE}	Input-asynchronous	Output enable, asynchronous input, active LOW. Controls the direction of the I/O pins. When LOW, the I/O pins behave as outputs. When deasserted HIGH, I/O pins are tristated, and act as input data pins. \overline{OE} is masked during the first clock of a read cycle when emerging from a deselected state.
\overline{ADV}	Input-synchronous	Advance input signal, sampled on the rising edge of CLK. When asserted, it automatically increments the address in a burst cycle.
ADSP	Input-synchronous	Address strobe from processor, sampled on the rising edge of CLK, active LOW. When asserted LOW, addresses presented to the device are captured in the address registers. A _[1:0] are also loaded into the burst counter. When ADSP and ADSC are both asserted, only ADSP is recognized. ADSP is ignored when \overline{CE}_1 is deasserted HIGH.
ADSC	Input-synchronous	Address strobe from controller, sampled on the rising edge of CLK, active LOW. When asserted LOW, addresses presented to the device are captured in the address registers. A _[1:0] are also loaded into the burst counter. When ADSP and ADSC are both asserted, only ADSP is recognized.
\overline{BWE}	Input-synchronous	Byte write enable input, active LOW. Sampled on the rising edge of CLK. This signal must be asserted LOW to conduct a byte write.
ZZ	Input-asynchronous	ZZ “sleep” input, active HIGH. When asserted HIGH places the device in a non-time-critical “sleep” condition with data integrity preserved. For normal operation, this pin has to be LOW or left floating. ZZ pin has an internal pull down.
DQ _s	I/O-synchronous	Bidirectional data I/O lines. As inputs, they feed into an on-chip data register that is triggered by the rising edge of CLK. As outputs, they deliver the data contained in the memory location specified by the addresses presented during the previous clock rise of the read cycle. The direction of the pins is controlled by \overline{OE} . When \overline{OE} is asserted LOW, the pins behave as outputs. When HIGH, DQ _s and DQP _x are placed in a tristate condition. The outputs are automatically tristated during the data portion of a write sequence, during the first clock when emerging from a deselected state, and when the device is deselected, regardless of the state of \overline{OE} .
DQP _x	I/O-synchronous	Bidirectional data parity I/O lines. Functionally, these signals are identical to DQ _s . During write sequences, DQP _x is controlled by \overline{BW}_X correspondingly.
MODE	Input-static	Selects burst order. When tied to GND selects linear burst sequence. When tied to V _{DD} or left floating selects interleaved burst sequence. This is a strap pin and should remain static during device operation. Mode Pin has an internal pull-up.
V _{DD}	Power supply	Power supply inputs to the core of the device.

Note

2. CE₃ is for A version of 100-pin TQFP (3 Chip Enable Option). 119-ball BGA is offered only in 2 Chip Enable.

Pin Definitions *(continued)*

Name	I/O	Description
V _{DDQ}	I/O power supply	Power supply for the I/O circuitry.
V _{SS}	Ground	Ground for the core of the device.
V _{SSQ}	I/O ground	Ground for the I/O circuitry.
TDO	JTAG serial output synchronous	Serial data-out to the JTAG circuit. Delivers data on the negative edge of TCK. If the JTAG feature is not being used, this pin can be left floating or connected to V _{DD} through a pull up resistor. This pin is not available on TQFP packages.
TDI	JTAG serial input synchronous	Serial data-in to the JTAG circuit. Sampled on the rising edge of TCK. If the JTAG feature is not being used, this pin can be left floating or connected to V _{DD} through a pull up resistor. This pin is not available on TQFP packages.
TMS	JTAG serial input synchronous	Serial data-in to the JTAG circuit. Sampled on the rising edge of TCK. If the JTAG feature is not being used, this pin can be disconnected or connected to V _{DD} . This pin is not available on TQFP packages.
TCK	JTAG-clock	Clock input to the JTAG circuitry. If the JTAG feature is not being used, this pin must be connected to V _{SS} . This pin is not available on TQFP packages.
NC	–	No connects. Not internally connected to the die. 18M, 36M, 72M, 144M, 288M, 576M, and 1G are address expansion pins and are not internally connected to the die.
V _{SS} /DNU	Ground/DNU	This pin can be connected to ground or should be left floating.

Functional Overview

All synchronous inputs pass through input registers controlled by the rising edge of the clock. Maximum access delay from the clock rise (t_{CDV}) is 6.5 ns (133 MHz device).

The CY7C1361C/CY7C1363C supports secondary cache in systems using either a linear or interleaved burst sequence. The interleaved burst order supports Pentium and i486™ processors. The linear burst sequence is suited for processors that use a linear burst sequence. The burst order is user-selectable, and is determined by sampling the MODE input. Accesses can be initiated with either the processor address strobe (ADSP) or the controller address strobe (ADSC). Address advancement through the burst sequence is controlled by the ADV input. A two-bit on-chip wraparound burst counter captures the first address in a burst sequence and automatically increments the address for the rest of the burst access.

Byte write operations are qualified with the byte write enable (BWE) and byte write select (BW_X) inputs. A global write enable (GW) overrides all byte write inputs and writes data to all four bytes. All writes are simplified with on-chip synchronous self-timed write circuitry.

Three synchronous chip selects (\overline{CE}_1 , CE₂, \overline{CE}_3 ^[3]) and an asynchronous output enable (OE) provide for easy bank selection and output tristate control. ADSP is ignored if CE₁ is HIGH.

Single Read Accesses

A single read access is initiated when the following conditions are satisfied at clock rise: (1) \overline{CE}_1 , CE₂, and CE₃^[3] are all asserted active and (2) ADSP or ADSC is asserted LOW (if the access is initiated by ADSC, the write inputs must be deasserted during this first cycle). The address presented to the address inputs is latched into the address register and the burst counter/control logic and presented to the memory core. If the OE input is asserted LOW, the requested data will be available at the data outputs a maximum to t_{CDV} after clock rise. ADSP is ignored if CE₁ is HIGH.

Single Write Accesses Initiated by ADSP

This access is initiated when the following conditions are satisfied at clock rise: (1) \overline{CE}_1 , CE₂, CE₃^[3] are all asserted active and (2) ADSP is asserted LOW. The addresses presented are loaded into the address register and the burst inputs (\overline{GW} , \overline{BWE} , and BW_X) are ignored during this first clock cycle. If the write inputs are asserted active (see [Partial Truth Table for Read/Write on page 12](#) for appropriate states that indicate a write) on the next clock rise, the appropriate data will be latched and written into the device. Byte writes are allowed. All I/Os are tristated during a byte write. Since this is a common I/O device, the asynchronous OE input signal must be deasserted and the I/Os must be tristated prior to the presentation of data to DQs. As a safety precaution, the data lines are tristated once a write cycle is detected, regardless of the state of OE.

Note

3. CE₃ is for A version of 100-pin TQFP (3 Chip Enable Option). 119-ball BGA is offered only in 2 Chip Enable.

Single Write Accesses Initiated by $\overline{\text{ADSC}}$

This write access is initiated when the following conditions are satisfied at clock rise: (1) $\overline{\text{CE}}_1$, $\overline{\text{CE}}_2$, and $\overline{\text{CE}}_3^{[4]}$ are all asserted active, (2) $\overline{\text{ADSC}}$ is asserted LOW, (3) $\overline{\text{ADSP}}$ is deasserted HIGH, and (4) the write input signals ($\overline{\text{GW}}$, $\overline{\text{BWE}}$, and $\overline{\text{BW}}_X$) indicate a write access. $\overline{\text{ADSC}}$ is ignored if $\overline{\text{ADSP}}$ is active LOW.

The addresses presented are loaded into the address register and the burst counter/control logic and delivered to the memory core. The information presented to $\text{DQ}_{[A:D]}$ is written into the specified address location. Byte writes are allowed. All I/Os are tristated when a write is detected, even a byte write. Since this is a common I/O device, the asynchronous $\overline{\text{OE}}$ input signal must be deasserted and the I/Os must be tristated prior to the presentation of data to DQ_S . As a safety precaution, the data lines are tristated once a write cycle is detected, regardless of the state of $\overline{\text{OE}}$.

Burst Sequences

The CY7C1361C/CY7C1363C provides an on-chip two-bit wraparound burst counter inside the SRAM. The burst counter is fed by $A_{[1:0]}$, and can follow either a linear or interleaved burst order. The burst order is determined by the state of the MODE input. A LOW on MODE will select a linear burst sequence. A HIGH on MODE selects an interleaved burst order. Leaving MODE unconnected causes the device to default to a interleaved burst sequence.

Sleep Mode

The ZZ input pin is an asynchronous input. Asserting ZZ places the SRAM in a power conservation 'sleep' mode. Two clock cycles are required to enter into or exit from this 'sleep' mode. While in this mode, data integrity is guaranteed. Accesses

pending when entering the 'sleep' mode are not considered valid nor is the completion of the operation guaranteed. The device must be deselected prior to entering the 'sleep' mode. $\overline{\text{CE}}_1$, $\overline{\text{CE}}_2$, $\overline{\text{CE}}_3^{[4]}$, $\overline{\text{ADSP}}$, and $\overline{\text{ADSC}}$ must remain inactive for the duration of t_{ZZREC} after the ZZ input returns LOW.

Interleaved Burst Address Table

(MODE = Floating or V_{DD})

First Address A1:A0	Second Address A1:A0	Third Address A1:A0	Fourth Address A1:A0
00	01	10	11
01	00	11	10
10	11	00	01
11	10	01	00

Linear Burst Address Table

(MODE = GND)

First Address A1:A0	Second Address A1:A0	Third Address A1:A0	Fourth Address A1:A0
00	01	10	11
01	10	11	00
10	11	00	01
11	00	01	10

ZZ Mode Electrical Characteristics

Parameter	Description	Test Conditions	Min	Max	Unit	
I_{DDZZ}	Sleep mode standby current	$\text{ZZ} \geq V_{\text{DD}} - 0.2 \text{ V}$	Commercial/Industrial	–	50	mA
			Automotive	–	60	mA
t_{ZZS}	Device operation to ZZ	$\text{ZZ} \geq V_{\text{DD}} - 0.2 \text{ V}$	–	$2t_{\text{CYC}}$	ns	
t_{ZZREC}	ZZ recovery time	$\text{ZZ} \leq 0.2 \text{ V}$	$2t_{\text{CYC}}$	–	ns	
t_{ZZI}	ZZ active to sleep current	This parameter is sampled	–	$2t_{\text{CYC}}$	ns	
t_{RZZI}	ZZ Inactive to exit sleep current	This parameter is sampled	0	–	ns	

Note

4. $\overline{\text{CE}}_3$ is for A version of 100-pin TQFP (3 Chip Enable Option). 119-ball BGA is offered only in 2 Chip Enable.

Truth Table

The Truth Table for CY7C1361C and CY7C1363C follows. [5, 6, 7, 8, 9]

Cycle Description	Address Used	\overline{CE}_1	CE_2	\overline{CE}_3	ZZ	\overline{ADSP}	\overline{ADSC}	\overline{ADV}	\overline{WRITE}	\overline{OE}	CLK	DQ
Deselected cycle, power-down	None	H	X	X	L	X	L	X	X	X	L-H	Tri-state
Deselected cycle, power-down	None	L	L	X	L	L	X	X	X	X	L-H	Tri-state
Deselected cycle, power-down	None	L	X	H	L	L	X	X	X	X	L-H	Tri-state
Deselected cycle, power-down	None	L	L	X	L	H	L	X	X	X	L-H	Tri-state
Deselected cycle, power-down	None	X	X	H	L	H	L	X	X	X	L-H	Tri-state
Sleep mode, power-down	None	X	X	X	H	X	X	X	X	X	X	Tri-state
Read cycle, begin burst	External	L	H	L	L	L	X	X	X	L	L-H	Q
Read cycle, begin burst	External	L	H	L	L	L	X	X	X	H	L-H	Tri-state
Write cycle, begin burst	External	L	H	L	L	H	L	X	L	X	L-H	D
Read cycle, begin burst	External	L	H	L	L	H	L	X	H	L	L-H	Q
Read cycle, begin burst	External	L	H	L	L	H	L	X	H	H	L-H	Tri-state
Read cycle, continue burst	Next	X	X	X	L	H	H	L	H	L	L-H	Q
Read cycle, continue burst	Next	X	X	X	L	H	H	L	H	H	L-H	Tri-state
Read cycle, continue burst	Next	H	X	X	L	X	H	L	H	L	L-H	Q
Read cycle, continue burst	Next	H	X	X	L	X	H	L	H	H	L-H	Tri-state
Write cycle, continue burst	Next	X	X	X	L	H	H	L	L	X	L-H	D
Write cycle, continue burst	Next	H	X	X	L	X	H	L	L	X	L-H	D
Read cycle, suspend burst	Current	X	X	X	L	H	H	H	H	L	L-H	Q
Read cycle, suspend burst	Current	X	X	X	L	H	H	H	H	H	L-H	Tri-state
Read cycle, suspend burst	Current	H	X	X	L	X	H	H	H	L	L-H	Q
Read cycle, suspend burst	Current	H	X	X	L	X	H	H	H	H	L-H	Tri-state
Write cycle, suspend burst	Current	X	X	X	L	H	H	H	L	X	L-H	D
Write cycle, suspend burst	Current	H	X	X	L	X	H	H	L	X	L-H	D

Notes

- X = "Don't Care." H = Logic HIGH, L = Logic LOW.
- $\overline{WRITE} = L$ when any one or more byte write enable signals and $\overline{BWE} = L$ or $\overline{GW} = L$. $\overline{WRITE} = H$ when all byte write enable signals, \overline{BWE} , $\overline{GW} = H$.
- The DQ pins are controlled by the current cycle and the OE signal. OE is asynchronous and is not sampled with the clock.
- The SRAM always initiates a read cycle when ADSP is asserted, regardless of the state of \overline{GW} , \overline{BWE} , or \overline{BW}_x . Writes may occur only on subsequent clocks after the ADSP or with the assertion of ADSC. As a result, OE must be driven HIGH prior to the start of the write cycle to allow the outputs to tri-state. OE is a don't care for the remainder of the write cycle.
- OE is asynchronous and is not sampled with the clock rise. It is masked internally during write cycles. During a read cycle all data bits are tri-state when OE is inactive or when the device is deselected, and all data bits behave as output when OE is active (LOW).

Partial Truth Table for Read/Write

The Partial Truth Table for Read/Write for CY7C1361C follows. [10, 11]

Function (CY7C1361C)	\overline{GW}	\overline{BWE}	\overline{BW}_D	\overline{BW}_C	\overline{BW}_B	\overline{BW}_A
Read	H	H	X	X	X	X
Read	H	L	H	H	H	H
Write byte (A, DQP _A)	H	L	H	H	H	L
Write byte (B, DQP _B)	H	L	H	H	L	H
Write bytes (B, A, DQP _A , DQP _B)	H	L	H	H	L	L
Write byte (C, DQP _C)	H	L	H	L	H	H
Write bytes (C, A, DQP _C , DQP _A)	H	L	H	L	H	L
Write bytes (C, B, DQP _C , DQP _B)	H	L	H	L	L	H
Write bytes (C, B, A, DQP _C , DQP _B , DQP _A)	H	L	H	L	L	L
Write byte (D, DQP _D)	H	L	L	H	H	H
Write bytes (D, A, DQP _D , DQP _A)	H	L	L	H	H	L
Write bytes (D, B, DQP _D , DQP _B)	H	L	L	H	L	H
Write bytes (D, B, A, DQP _D , DQP _B , DQP _A)	H	L	L	H	L	L
Write bytes (D, B, DQP _D , DQP _B)	H	L	L	L	H	H
Write bytes (D, B, A, DQP _D , DQP _C , DQP _A)	H	L	L	L	H	L
Write bytes (D, C, A, DQP _D , DQP _B , DQP _A)	H	L	L	L	L	H
Write all bytes	H	L	L	L	L	L
Write all bytes	L	X	X	X	X	X

Partial Truth Table for Read/Write

The Partial Truth Table for Read/Write for CY7C1363C follows. [10, 11]

Function (CY7C1363C)	\overline{GW}	\overline{BWE}	\overline{BW}_B	\overline{BW}_A
Read	H	H	X	X
Read	H	L	H	H
Write byte A – (DQ _A and DQP _A)	H	L	H	L
Write byte B – (DQ _B and DQP _B)	H	L	L	H
Write all bytes	H	L	L	L
Write all bytes	L	X	X	X

Notes

10. X = "Don't Care." H = Logic HIGH, L = Logic LOW.

11. Table only lists a partial listing of the byte write combinations. Any Combination of \overline{BW}_X is valid Appropriate write will be done based on which byte write is active.

IEEE 1149.1 Serial Boundary Scan (JTAG)

The CY7C1361C incorporates a serial boundary scan test access port (TAP) in the BGA package only. The TQFP package does not offer this functionality. This part operates in accordance with IEEE Standard 1149.1-1900, but does not have the set of functions required for full 1149.1 compliance. These functions from the IEEE specification are excluded because their inclusion places an added delay in the critical speed path of the SRAM. Note that the TAP controller functions in a manner that does not conflict with the operation of other devices using 1149.1 fully compliant TAPs. The TAP operates using JEDEC-standard 3.3 V or 2.5 V I/O logic levels.

The CY7C1361C contains a TAP controller, instruction register, boundary scan register, bypass register, and ID register.

Disabling the JTAG Feature

It is possible to operate the SRAM without using the JTAG feature. To disable the TAP controller, TCK must be tied LOW (V_{SS}) to prevent clocking of the device. TDI and TMS are internally pulled up and may be unconnected. They may alternately be connected to V_{DD} through a pull-up resistor. TDO should be left unconnected. Upon power up, the device comes up in a reset state which does not interfere with the operation of the device.

Test Access Port (TAP)

Test Clock (TCK)

The test clock is used only with the TAP controller. All inputs are captured on the rising edge of TCK. All outputs are driven from the falling edge of TCK.

Test Mode Select (TMS)

The TMS input is used to give commands to the TAP controller and is sampled on the rising edge of TCK. It is allowable to leave this ball unconnected if the TAP is not used. The ball is pulled up internally, resulting in a logic HIGH level.

Test Data-In (TDI)

The TDI ball is used to serially input information into the registers and can be connected to the input of any of the registers. The register between TDI and TDO is chosen by the instruction that is loaded into the TAP instruction register. For information about loading the instruction register, see the [TAP Controller State Diagram on page 15](#). TDI is internally pulled up and can be unconnected if the TAP is unused in an application. TDI is connected to the most significant bit (MSB) of any register.

Test Data-Out (TDO)

The TDO output ball is used to serially clock data-out from the registers. The output is active depending upon the current state of the TAP state machine (see [Instruction Codes on page 19](#)). The output changes on the falling edge of TCK. TDO is connected to the least significant bit (LSB) of any register.

Performing a TAP Reset

A RESET is performed by forcing TMS HIGH (V_{DD}) for five rising edges of TCK. This RESET does not affect the operation of the SRAM and may be performed while the SRAM is operating.

At power up, the TAP is reset internally to ensure that TDO comes up in a high Z state.

TAP Registers

Registers are connected between the TDI and TDO balls and allow data to be scanned into and out of the SRAM test circuitry. Only one register can be selected at a time through the instruction register. Data is serially loaded into the TDI ball on the rising edge of TCK. Data is output on the TDO ball on the falling edge of TCK.

Instruction Register

Three-bit instructions can be serially loaded into the instruction register. This register is loaded when it is placed between the TDI and TDO balls as shown in the [TAP Controller Block Diagram on page 16](#). Upon power-up, the instruction register is loaded with the IDCODE instruction. It is also loaded with the IDCODE instruction if the controller is placed in a reset state as described in the previous section.

When the TAP controller is in the Capture-IR state, the two least significant bits are loaded with a binary '01' pattern to enable fault isolation of the board-level serial test data path.

Bypass Register

To save time when serially shifting data through registers, it is sometimes advantageous to skip certain chips. The bypass register is a single-bit register that can be placed between the TDI and TDO balls. This enables data to be shifted through the SRAM with minimal delay. The bypass register is set LOW (V_{SS}) when the BYPASS instruction is executed.

Boundary Scan Register

The boundary scan register is connected to all the input and bidirectional balls on the SRAM.

The boundary scan register is loaded with the contents of the RAM I/O ring when the TAP controller is in the Capture-DR state and is then placed between the TDI and TDO balls when the controller is moved to the Shift-DR state. The EXTEST, SAMPLE/PRELOAD, and SAMPLE Z instructions can be used to capture the contents of the I/O ring.

The [Boundary Scan Order on page 20](#) show the order in which the bits are connected. Each bit corresponds to one of the bumps on the SRAM package. The MSB of the register is connected to TDI and the LSB is connected to TDO.

Identification (ID) Register

The ID register is loaded with a vendor-specific, 32-bit code during the Capture-DR state when the IDCODE command is loaded in the instruction register. The IDCODE is hardwired into the SRAM and can be shifted out when the TAP controller is in the Shift-DR state. The ID register has a vendor code and other information described in [Identification Register Definitions on page 19](#).

TAP Instruction Set

Overview

Eight different instructions are possible with the three-bit instruction register. All combinations are listed in the [Instruction Codes on page 19](#). Three of these instructions are listed as RESERVED and should not be used. The other five instructions are described in detail in this section.

The TAP controller used in this SRAM is not fully compliant to the 1149.1 convention because some of the mandatory 1149.1 instructions are not fully implemented.

The TAP controller cannot be used to load address data or control signals into the SRAM and cannot preload the I/O buffers. The SRAM does not implement the 1149.1 commands EXTEST or INTEST or the PRELOAD portion of SAMPLE/PRELOAD; rather, it performs a capture of the I/O ring when these instructions are executed.

Instructions are loaded into the TAP controller during the Shift-IR state when the instruction register is placed between TDI and TDO. During this state, instructions are shifted through the instruction register through the TDI and TDO balls. To execute the instruction once it is shifted in, the TAP controller needs to be moved into the Update-IR state.

EXTEST

EXTEST is a mandatory 1149.1 instruction which is to be executed whenever the instruction register is loaded with all 0s. EXTEST is not implemented in this SRAM TAP controller, and therefore this device is not compliant to 1149.1. The TAP controller does not recognize an all-0 instruction.

When an EXTEST instruction is loaded into the instruction register, the SRAM responds as if a SAMPLE/PRELOAD instruction has been loaded. There is one difference between the two instructions. Unlike the SAMPLE/PRELOAD instruction, EXTEST places the SRAM outputs in a high Z state.

IDCODE

The IDCODE instruction causes a vendor-specific, 32-bit code to be loaded into the instruction register. It also places the instruction register between the TDI and TDO balls and enables the IDCODE to be shifted out of the device when the TAP controller enters the Shift-DR state.

The IDCODE instruction is loaded into the instruction register upon power-up or whenever the TAP controller is given a test logic reset state.

SAMPLE Z

The SAMPLE Z instruction causes the boundary scan register to be connected between the TDI and TDO balls when the TAP

controller is in a Shift-DR state. It also places all SRAM outputs into a high Z state.

SAMPLE/PRELOAD

SAMPLE/PRELOAD is a 1149.1-mandatory instruction. When the SAMPLE/PRELOAD instructions are loaded into the instruction register and the TAP controller is in the Capture-DR state, a snapshot of data on the inputs and output pins is captured in the boundary scan register.

The user must be aware that the TAP controller clock can only operate at a frequency up to 20 MHz, while the SRAM clock operates more than an order of magnitude faster. Because there is a large difference in the clock frequencies, it is possible that during the Capture-DR state, an input or output undergoes a transition. The TAP may then try to capture a signal while in transition (metastable state). This does not harm the device, but there is no guarantee as to the value that will be captured. Repeatable results may not be possible.

To guarantee that the boundary scan register captures the correct value of a signal, the SRAM signal must be stabilized long enough to meet the TAP controller's capture setup plus hold times (t_{CS} and t_{CH}). The SRAM clock input might not be captured correctly if there is no way in a design to stop (or slow) the clock during a SAMPLE/PRELOAD instruction. If this is an issue, it is still possible to capture all other signals and simply ignore the value of the CK and CK# captured in the boundary scan register.

After the data is captured, it is possible to shift out the data by putting the TAP into the Shift-DR state. This places the boundary scan register between the TDI and TDO pins.

PRELOAD enables an initial data pattern to be placed at the latched parallel outputs of the boundary scan register cells prior to the selection of another boundary scan test operation.

The shifting of data for the SAMPLE and PRELOAD phases can occur concurrently when required - that is, while data captured is shifted out, the preloaded data can be shifted in.

BYPASS

When the BYPASS instruction is loaded in the instruction register and the TAP is placed in a Shift-DR state, the bypass register is placed between the TDI and TDO balls. The advantage of the BYPASS instruction is that it shortens the boundary scan path when multiple devices are connected together on a board.

Reserved

These instructions are not implemented but are reserved for future use. Do not use these instructions.

TAP Controller State Diagram

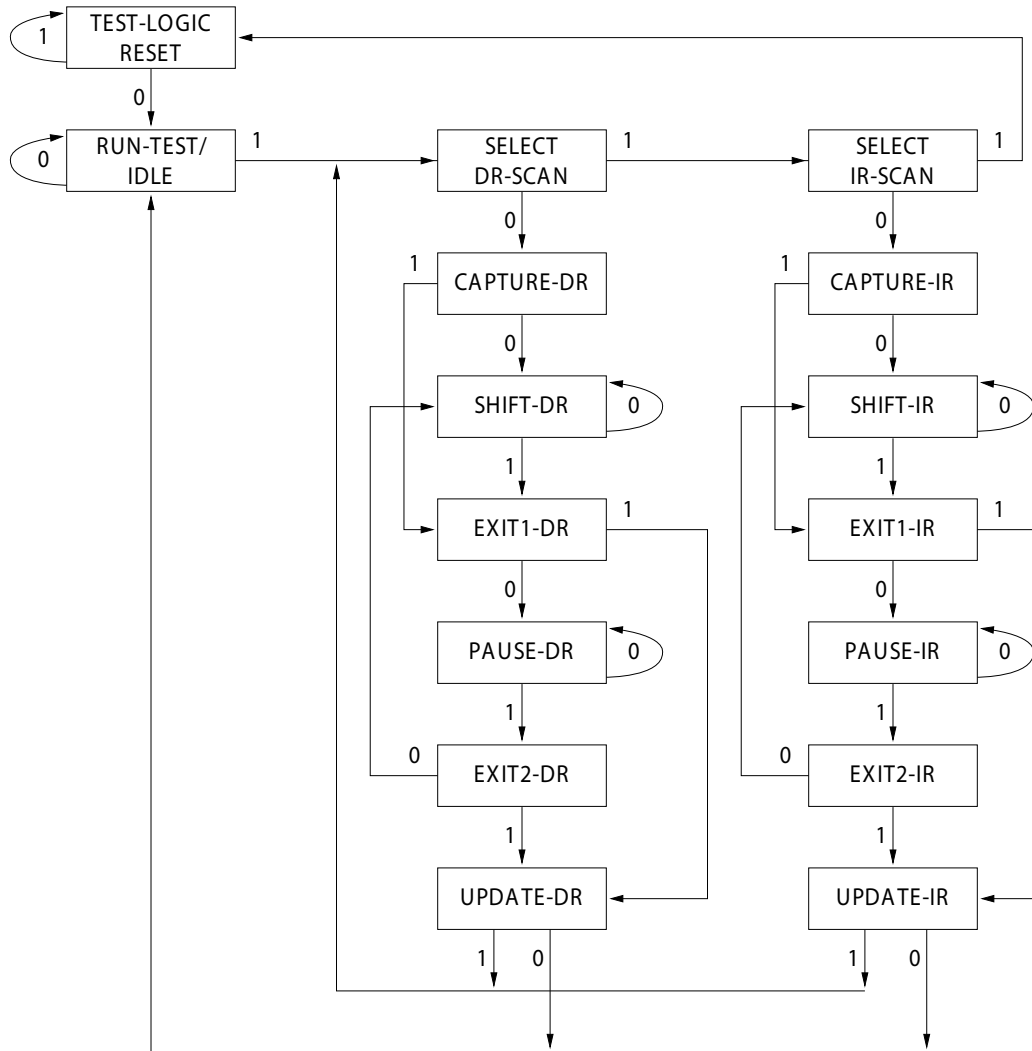

The 0/1 next to each state represents the value of TMS at the rising edge of TCK.

TAP Controller Block Diagram

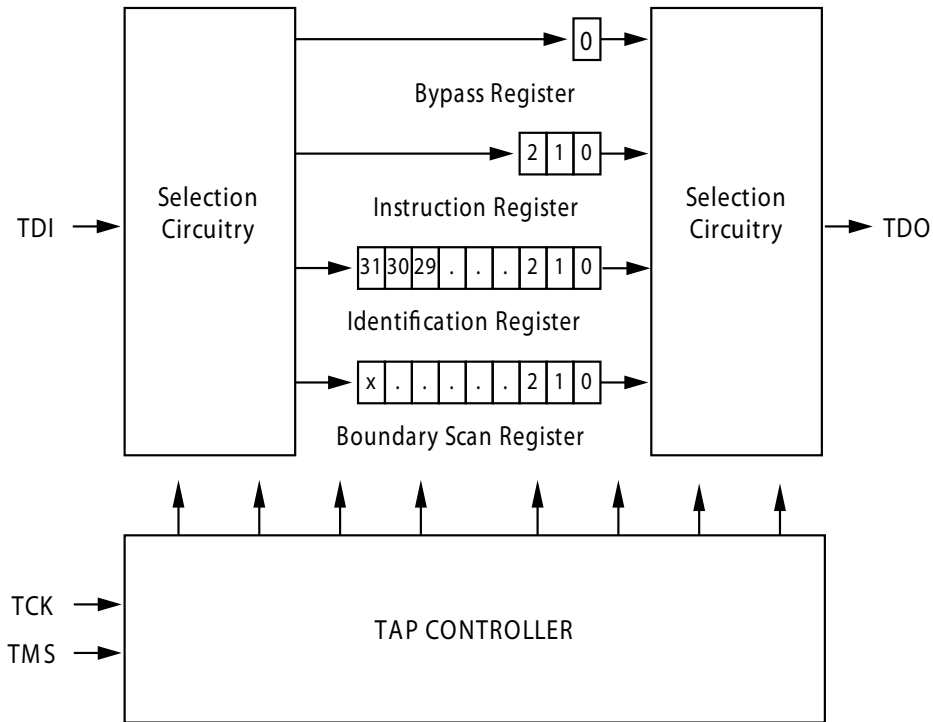

TAP Timing

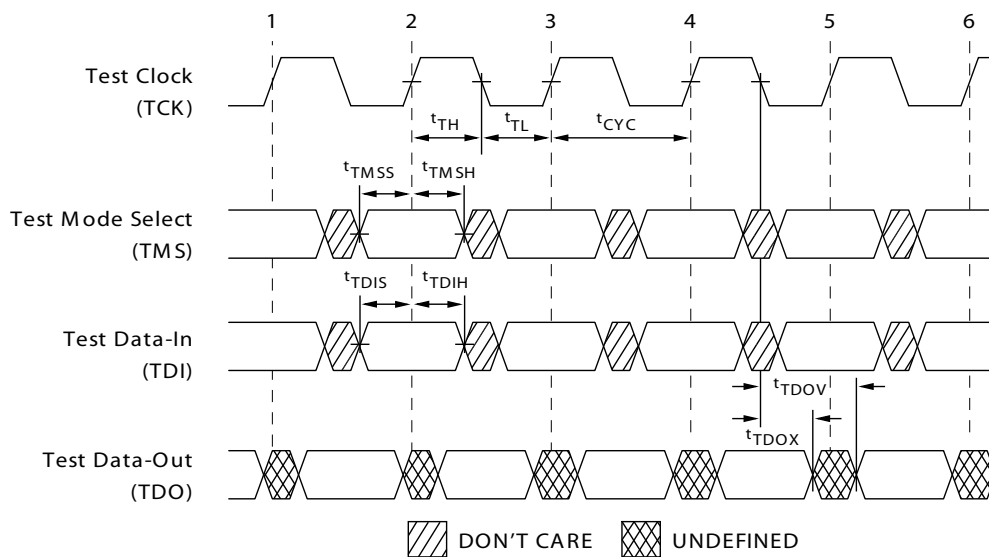

TAP AC Switching Characteristics

Over the Operating Range

Parameter ^[12, 13]	Parameter	Min	Max	Unit
Clock				
t_{TCYC}	TCK clock cycle time	50	–	ns
t_{TF}	TCK clock frequency	–	20	MHz
t_{TH}	TCK clock HIGH time	20	–	ns
t_{TL}	TCK clock LOW time	20	–	ns
Output Times				
t_{TDOV}	TCK clock LOW to TDO valid	–	10	ns
t_{TDOX}	TCK clock LOW to TDO invalid	0	–	ns
Set-up Times				
t_{TMSS}	TMS setup to TCK clock rise	5	–	ns
t_{TDIS}	TDI setup to TCK clock rise	5	–	ns
t_{CS}	Capture setup to TCK rise	5	–	ns
Hold Times				
t_{TMSh}	TMS hold after TCK clock rise	5	–	ns
t_{TDIH}	TDI hold after clock rise	5	–	ns
t_{CH}	Capture hold after clock rise	5	–	ns

3.3 V TAP AC Test Conditions

Input pulse levels V_{SS} to 3.3 V
 Input rise and fall times 1 ns
 Input timing reference levels 1.5 V
 Output reference levels 1.5 V
 Test load termination supply voltage 1.5 V

3.3 V TAP AC Output Load Equivalent

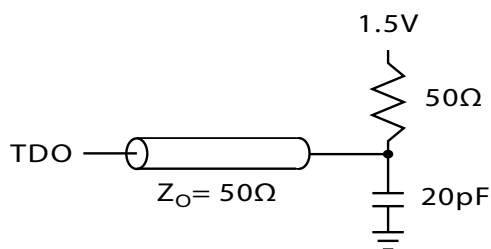

2.5 V TAP AC Test Conditions

Input pulse levels V_{SS} to 2.5 V
 Input rise and fall time 1 ns
 Input timing reference levels 1.25 V
 Output reference levels 1.25 V
 Test load termination supply voltage 1.25 V

2.5 V TAP AC Output Load Equivalent

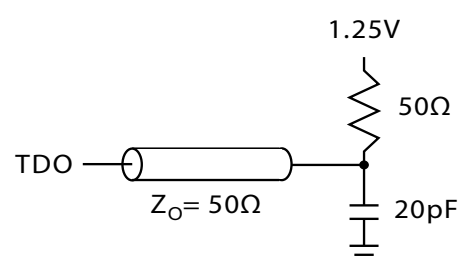

Notes

- 12. t_{CS} and t_{CH} refer to the setup and hold time requirements of latching data from the boundary scan register.
- 13. Test conditions are specified using the load in TAP AC test conditions. $t_r/t_f = 1$ ns.

TAP DC Electrical Characteristics and Operating Conditions

(0 °C < T_A < +70 °C; V_{DD} = 3.3 V ± 0.165 V unless otherwise noted)

Parameter ^[14]	Description	Test Conditions		Min	Max	Unit
V _{OH1}	Output HIGH voltage	I _{OH} = -4.0 mA	V _{DDQ} = 3.3 V	2.4	-	V
		I _{OH} = -1.0 mA	V _{DDQ} = 2.5 V	2.0	-	V
V _{OH2}	Output HIGH voltage	I _{OH} = -100 μA	V _{DDQ} = 3.3 V	2.9	-	V
			V _{DDQ} = 2.5 V	2.1	-	V
V _{OL1}	Output LOW voltage	I _{OL} = 8.0 mA	V _{DDQ} = 3.3 V	-	0.4	V
		I _{OL} = 8.0 mA	V _{DDQ} = 2.5 V	-	0.4	V
V _{OL2}	Output LOW voltage	I _{OL} = 100 μA	V _{DDQ} = 3.3 V	-	0.2	V
			V _{DDQ} = 2.5 V	-	0.2	V
V _{IH}	Input HIGH voltage		V _{DDQ} = 3.3 V	2.0	V _{DD} + 0.3	V
			V _{DDQ} = 2.5 V	1.7	V _{DD} + 0.3	V
V _{IL}	Input LOW voltage		V _{DDQ} = 3.3 V	-0.5	0.7	V
			V _{DDQ} = 2.5 V	-0.3	0.7	V
I _X	Input load current	GND ≤ V _{IN} ≤ V _{DDQ}		-5	5	μA

Note

14. All voltages referenced to V_{SS} (GND).

Identification Register Definitions

Instruction Field	CY7C1361C (256K × 36)	Description
Revision number (31:29)	000	Describes the version number.
Device depth (28:24) ^[15]	01011	Reserved for Internal Use
Device width (23:18) 119-ball BGA	101001	Defines memory type and architecture
Cypress device ID (17:12)	100110	Defines width and density
Cypress JEDEC ID Code (11:1)	00000110100	Allows unique identification of SRAM vendor.
ID register presence indicator (0)	1	Indicates the presence of an ID register.

Scan Register Sizes

Register Name	Bit Size (× 36)
Instruction	3
Bypass	1
ID	32
Boundary scan order (119-ball BGA package)	71

Instruction Codes

Instruction	Code	Description
EXTEST	000	Captures I/O ring contents. Places the boundary scan register between TDI and TDO. Forces all SRAM outputs to high Z state.
IDCODE	001	Loads the ID register with the vendor ID code and places the register between TDI and TDO. This operation does not affect SRAM operations.
SAMPLE Z	010	Captures I/O ring contents. Places the boundary scan register between TDI and TDO. Forces all SRAM output drivers to a high Z state.
RESERVED	011	Do Not Use: This instruction is reserved for future use.
SAMPLE/PRELOAD	100	Captures I/O ring contents. Places the boundary scan register between TDI and TDO. Does not affect SRAM operation.
RESERVED	101	Do Not Use: This instruction is reserved for future use.
RESERVED	110	Do Not Use: This instruction is reserved for future use.
BYPASS	111	Places the bypass register between TDI and TDO. This operation does not affect SRAM operations.

Note

¹⁵. Bit #24 is "1" in the Register Definitions for both 2.5 V and 3.3 V versions of this device.

Boundary Scan Order

119-ball BGA

CY7C1361C (256K × 36)

Bit #	Ball ID	Signal Name
1	K4	CLK
2	H4	\overline{GW}
3	M4	\overline{BWE}
4	F4	\overline{OE}
5	B4	\overline{ADSC}
6	A4	\overline{ADSP}
7	G4	ADV
8	C3	A
9	B3	A
10	D6	DQP _B
11	H7	DQ _B
12	G6	DQ _B
13	E6	DQ _B
14	D7	DQ _B
15	E7	DQ _B
16	F6	DQ _B
17	G7	DQ _B
18	H6	DQ _B
19	T7	ZZ
20	K7	DQ _A
21	L6	DQ _A
22	N6	DQ _A
23	P7	DQ _A
24	N7	DQ _A
25	M6	DQ _A
26	L7	DQ _A
27	K6	DQ _A
28	P6	DQP _A
29	T4	A
30	A3	A
31	C5	A
32	B5	A
33	A5	A
34	C6	A
35	A6	A
36	B6	A

Bit #	Ball ID	Signal Name
37	P4	A0
38	N4	A1
39	R6	A
40	T5	A
41	T3	A
42	R2	A
43	R3	MODE
44	P2	DQP _D
45	P1	DQ _D
46	L2	DQ _D
47	K1	DQ _D
48	N2	DQ _D
49	N1	DQ _D
50	M2	DQ _D
51	L1	DQ _D
52	K2	DQ _D
53	Internal	Internal
54	H1	DQ _C
55	G2	DQ _C
56	E2	DQ _C
57	D1	DQ _C
58	H2	DQ _C
59	G1	DQ _C
60	F2	DQ _C
61	E1	DQ _C
62	D2	DQP _C
63	C2	A
64	A2	A
65	E4	\overline{CE}_1
66	B2	\overline{CE}_2
67	L3	\overline{BWD}
68	G3	\overline{BW}_C
69	G5	\overline{BW}_B
70	L5	\overline{BW}_A
71	Internal	Internal

Boundary Scan Order

165-ball FBGA

CY7C1361C (256K × 36)

Bit #	ball ID	Signal Name
1	B6	CLK
2	B7	\overline{GW}
3	A7	\overline{BWE}
4	B8	\overline{OE}
5	A8	\overline{ADSC}
6	B9	\overline{ADSP}
7	A9	\overline{ADV}
8	B10	A
9	A10	A
10	C11	DQP _B
11	E10	DQ _B
12	F10	DQ _B
13	G10	DQ _B
14	D10	DQ _B
15	D11	DQ _B
16	E11	DQ _B
17	F11	DQ _B
18	G11	DQ _B
19	H11	ZZ
20	J10	DQ _A
21	K10	DQ _A
22	L10	DQ _A
23	M10	DQ _A
24	J11	DQ _A
25	K11	DQ _A
26	L11	DQ _A
27	M11	DQ _A
28	N11	DQP _A
29	R11	A
30	R10	A
31	P10	A
32	R9	A
33	P9	A
34	R8	A
35	P8	A
36	P11	A

Bit #	ball ID	Signal Name
37	R6	A0
38	P6	A1
39	R4	A
40	P4	A
41	R3	A
42	P3	A
43	R1	MODE
44	N1	DQP _D
45	L2	DQ _D
46	K2	DQ _D
47	J2	DQ _D
48	M2	DQ _D
49	M1	DQ _D
50	L1	DQ _D
51	K1	DQ _D
52	J1	DQ _D
53	Internal	Internal
54	G2	DQ _C
55	F2	DQ _C
56	E2	DQ _C
57	D2	DQ _C
58	G1	DQ _C
59	F1	DQ _C
60	E1	DQ _C
61	D1	DQ _C
62	C1	DQP _C
63	B2	A
64	A2	A
65	A3	CE ₁
66	B3	CE ₂
67	B4	\overline{BW}_D
68	A4	\overline{BW}_C
69	A5	\overline{BW}_B
70	B5	\overline{BW}_A
71	A6	\overline{CE}_3

Maximum Ratings

Exceeding maximum ratings may impair the useful life of the device. These user guidelines are not tested.

Storage temperature	-65 °C to + 150 °C
Ambient temperature with power applied	-55 °C to + 125 °C
Supply voltage on V _{DD} relative to GND	-0.5 V to + 4.6 V
Supply voltage on V _{DDQ} relative to GND	-0.5 V to + V _{DD}
DC voltage applied to outputs in tri-state	-0.5 V to V _{DDQ} + 0.5 V
DC input voltage	-0.5 V to V _{DD} + 0.5 V
Current into outputs (LOW)	20 mA
Static discharge voltage (per MIL-STD-883, method 3015)	> 2001 V
Latch-up current	> 200 mA

Operating Range

Range	Ambient Temperature	V _{DD}	V _{DDQ}
Commercial	0 °C to +70 °C	3.3 V – 5% / + 10%	2.5 V – 5% to V _{DD}
Industrial	-40 °C to +85 °C		
Automotive	-40 °C to +125 °C		

Neutron Soft Error Immunity

Parameter	Description	Test Conditions	Typ	Max*	Unit
LSBU	Logical single-bit upsets	25 °C	361	394	FIT/Mb
LMBU	Logical multi-bit upsets	25 °C	0	0.01	FIT/Mb
SEL	Single event latch up	85 °C	0	0.1	FIT/Dev

* No LMBU or SEL events occurred during testing; this column represents a statistical χ^2 , 95% confidence limit calculation. For more details refer to Application Note AN54908 "Accelerated Neutron SER Testing and Calculation of Terrestrial Failure Rates"

Electrical Characteristics

Over the Operating Range

Parameter ^[16, 17]	Description	Test Conditions	Min	Max	Unit
V _{DD}	Power supply voltage		3.135	3.6	V
V _{DDQ}	I/O supply voltage	for 3.3 V I/O	3.135	V _{DD}	V
		for 2.5 V I/O	2.375	2.625	V
V _{OH}	Output HIGH voltage	for 3.3 V I/O, I _{OH} = -4.0 mA	2.4	-	V
		for 2.5 V I/O, I _{OH} = -1.0 mA	2.0	-	V
V _{OL}	Output LOW voltage	for 3.3 V I/O, I _{OL} = 8.0 mA	-	0.4	V
		for 2.5 V I/O, I _{OL} = 1.0 mA	-	0.4	V
V _{IH}	Input HIGH voltage ^[16]	for 3.3 V I/O	2.0	V _{DD} + 0.3 V	V
		for 2.5 V I/O	1.7	V _{DD} + 0.3 V	V
V _{IL}	Input LOW voltage ^[16]	for 3.3 V I/O	-0.3	0.8	V
		for 2.5 V I/O	-0.3	0.7	V
I _X	Input leakage current except ZZ and MODE	GND ≤ V _I ≤ V _{DDQ}	-5	5	μA
	Input current of MODE	Input = V _{SS}	-30	-	μA
		Input = V _{DD}	-	5	μA
	Input current of ZZ	Input = V _{SS}	-5	-	μA
Input = V _{DD}		-	30	μA	
I _{OZ}	Output leakage current	GND ≤ V _I ≤ V _{DDQ} , output disabled	-5	5	μA

Notes

16. Overshoot: V_{IH(AC)} < V_{DD} + 1.5 V (Pulse width less than t_{CYC/2}), undershoot: V_{IL(AC)} > -2 V (Pulse width less than t_{CYC/2}).

17. T_{Power-up}: Assumes a linear ramp from 0 V to V_{DD(min)} within 200 ms. During this time V_{IH} < V_{DD} and V_{DDQ} ≤ V_{DD}.

Electrical Characteristics *(continued)*

Over the Operating Range

Parameter ^[16, 17]	Description	Test Conditions		Min	Max	Unit
I _{DD}	V _{DD} operating supply current	V _{DD} = Max, I _{OUT} = 0 mA, f = f _{MAX} = 1/t _{CYC}	7.5 ns cycle, 133 MHz	–	250	mA
			10 ns cycle, 100 MHz	–	180	
I _{SB1}	Automatic CE power-down current – TTL inputs	Max V _{DD} , device deselected, V _{IN} ≥ V _{IH} or V _{IN} ≤ V _{IL} , f = f _{MAX} , inputs switching	All speeds (Commercial /Industrial)	–	110	mA
			10 ns cycle, 100 MHz (Automotive)	–	150	mA
I _{SB2}	Automatic CE power-down current – CMOS inputs	Max V _{DD} , device deselected, V _{IN} ≥ V _{DD} – 0.3 V or V _{IN} ≤ 0.3 V, f = 0, inputs static	All speeds	–	40	mA
I _{SB3}	Automatic CE power-down current – CMOS inputs	Max V _{DD} , device deselected, V _{IN} ≥ V _{DDQ} – 0.3 V or V _{IN} ≤ 0.3 V, f = f _{MAX} , inputs switching	All speeds (Commercial /Industrial)	–	100	mA
			10 ns cycle, 100 MHz (Automotive)	–	120	mA
I _{SB4}	Automatic CE power-down current – TTL inputs	Max V _{DD} , device deselected, V _{IN} ≥ V _{IH} or V _{IN} ≤ V _{IL} , f = 0, inputs static	All speeds (Commercial /Industrial)	–	40	mA
			10 ns cycle, 100 MHz (Automotive)	–	60	mA

Capacitance

Parameter ^[18]	Description	Test Conditions	100-pin TQFP Max	119-ball BGA Max	165-ball FBGA Max	Unit
C _{IN}	Input capacitance	T _A = 25 °C, f = 1 MHz, V _{DD} = 3.3 V, V _{DDQ} = 2.5 V	5	5	5	pF
C _{CLK}	Clock input capacitance		5	5	5	pF
C _{I/O}	Input/output capacitance		5	7	7	pF

Thermal Resistance

Parameter ^[18]	Description	Test Conditions	100-pin TQFP Package	119-ball BGA Package	165-ball FBGA Package	Unit
Θ _{JA}	Thermal resistance (junction to ambient)	Test conditions follow standard test methods and procedures for measuring thermal impedance, according to EIA/JESD51	29.41	34.1	16.8	°C/W
Θ _{JC}	Thermal resistance (junction to case)		6.31	14.0	3.0	°C/W

Note

18. Tested initially and after any design or process change that may affect these parameters.

AC Test Loads and Waveforms

Figure 5. AC Test Loads and Waveforms

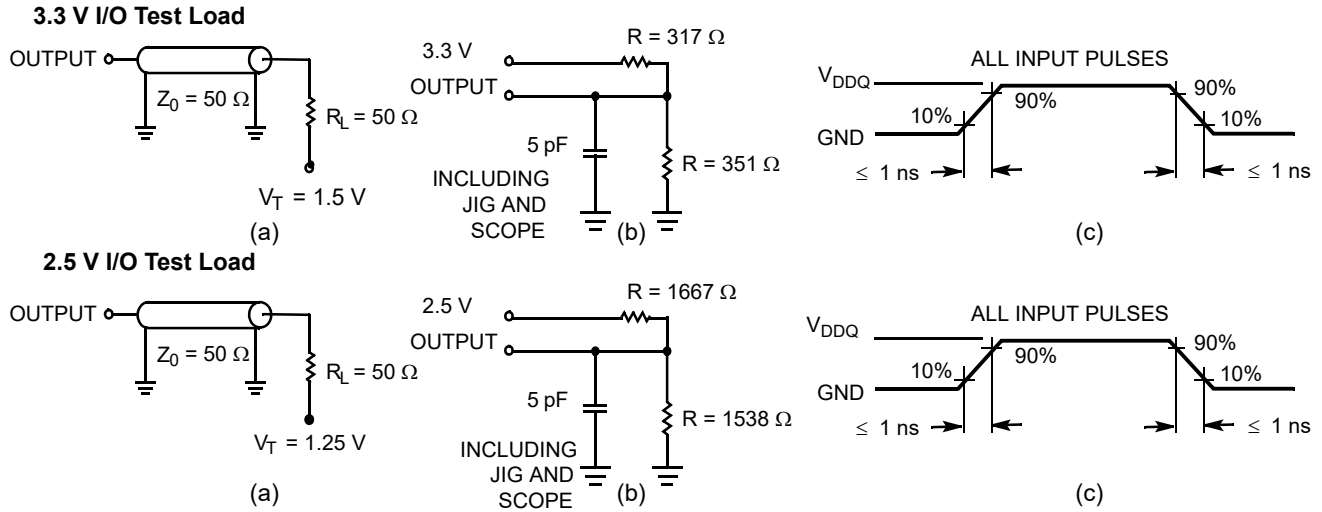

Switching Characteristics

Over the Operating Range

Parameter ^[19, 20]	Description	-133		-100		Unit
		Min	Max	Min	Max	
t _{POWER}	V _{DD} (typical) to the first access ^[21]	1	–	1	–	ms
Clock						
t _{CYC}	Clock cycle time	7.5	–	10	–	ns
t _{CH}	Clock HIGH	3.0	–	4.0	–	ns
t _{CL}	Clock LOW	3.0	–	4.0	–	ns
Output Times						
t _{CDV}	Data output valid after CLK rise	–	6.5	–	8.5	ns
t _{DOH}	Data output hold after CLK rise	2.0	–	2.0	–	ns
t _{CLZ}	Clock to low Z ^[22, 23, 24]	0	–	0	–	ns
t _{CHZ}	Clock to high Z ^[22, 23, 24]	–	3.5	–	3.5	ns
t _{OEV}	$\overline{\text{OE}}$ LOW to output valid	–	3.5	–	3.5	ns
t _{OELZ}	$\overline{\text{OE}}$ LOW to output low Z ^[22, 23, 24]	0	–	0	–	ns
t _{OEHZ}	$\overline{\text{OE}}$ HIGH to output high Z ^[22, 23, 24]	–	3.5	–	3.5	ns
Set-up Times						
t _{AS}	Address setup before CLK rise	1.5	–	1.5	–	ns
t _{ADS}	ADSP, ADSC setup before CLK rise	1.5	–	1.5	–	ns
t _{ADVS}	$\overline{\text{ADV}}$ setup before CLK rise	1.5	–	1.5	–	ns
t _{WES}	$\overline{\text{GW}}$, $\overline{\text{BWE}}$, $\overline{\text{BW}}_{[\text{A:D}]}$ setup before CLK rise	1.5	–	1.5	–	ns
t _{DS}	Data input setup before CLK rise	1.5	–	1.5	–	ns
t _{CES}	Chip enable setup	1.5	–	1.5	–	ns
Hold Times						
t _{AH}	Address hold after CLK rise	0.5	–	0.5	–	ns
t _{ADH}	ADSP, ADSC hold after CLK rise	0.5	–	0.5	–	ns
t _{WEH}	$\overline{\text{GW}}$, $\overline{\text{BWE}}$, $\overline{\text{BW}}_{[\text{A:D}]}$ hold after CLK rise	0.5	–	0.5	–	ns
t _{ADVH}	$\overline{\text{ADV}}$ hold after CLK rise	0.5	–	0.5	–	ns
t _{DH}	Data input hold after CLK rise	0.5	–	0.5	–	ns
t _{CEH}	Chip enable hold after CLK rise	0.5	–	0.5	–	ns

Notes

19. Timing reference level is 1.5 V when V_{DDQ} = 3.3 V and is 1.25 V when V_{DDQ} = 2.5 V.

20. Test conditions shown in (a) of [Figure 5 on page 24](#) unless otherwise noted.

21. This part has a voltage regulator internally; t_{POWER} is the time that the power needs to be supplied above V_{DD(minimum)} initially, before a read or write operation can be initiated.

22. t_{CHZ}, t_{CLZ}, t_{OELZ}, and t_{OEHZ} are specified with AC test conditions shown in part (b) of [Figure 5 on page 24](#). Transition is measured ± 200 mV from steady-state voltage.

23. At any given voltage and temperature, t_{OEHZ} is less than t_{OELZ} and t_{CHZ} is less than t_{CLZ} to eliminate bus contention between SRAMs when sharing the same data bus. These specifications do not imply a bus contention condition, but reflect parameters guaranteed over worst case user conditions. Device is designed to achieve high Z prior to low Z under the same system conditions.

24. This parameter is sampled and not 100% tested.

Timing Diagrams

Figure 6. Read Cycle Timing [25]

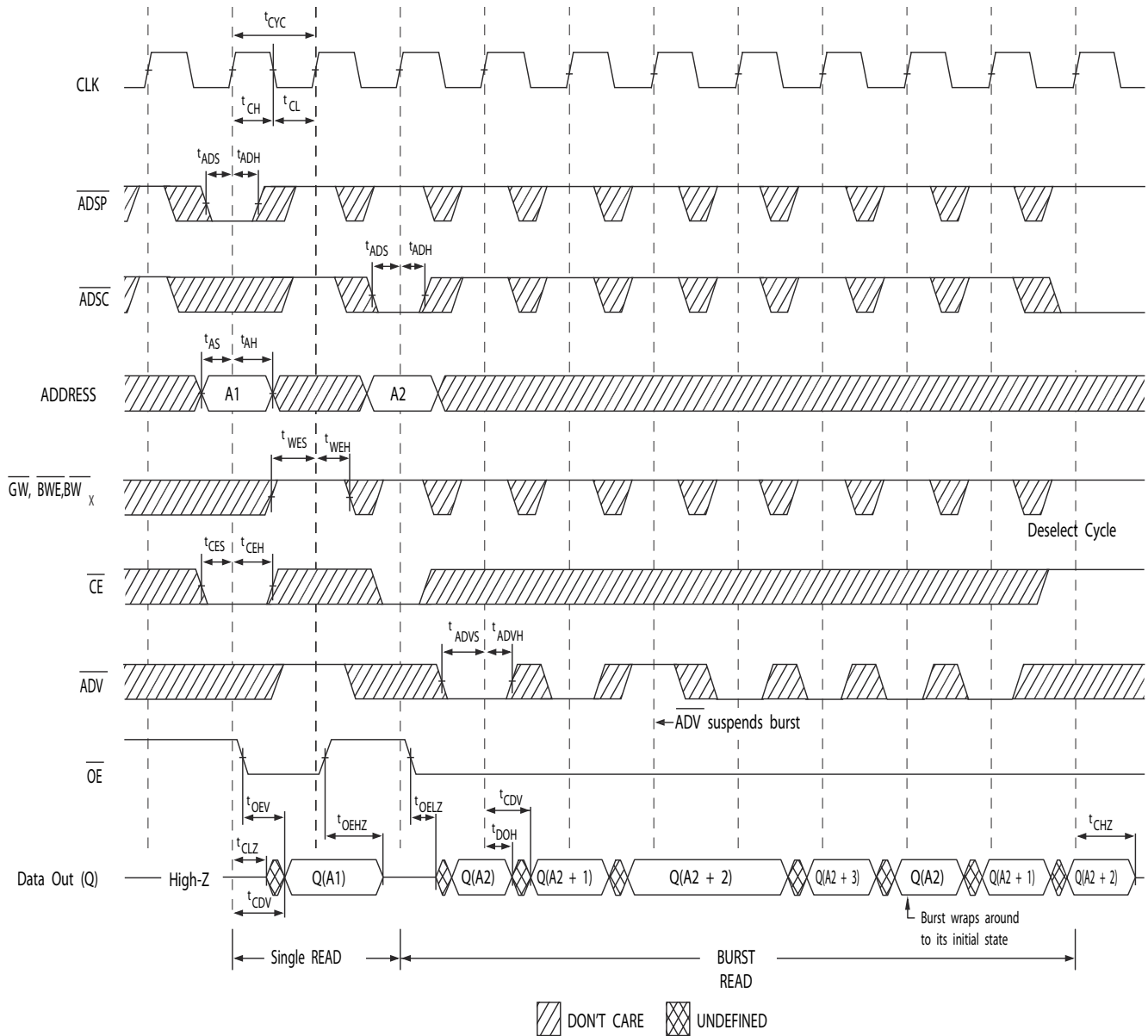

Note

25. On this diagram, when \overline{CE} is LOW: \overline{CE}_1 is LOW, CE_2 is HIGH and \overline{CE}_3 is LOW. When \overline{CE} is HIGH: \overline{CE}_1 is HIGH or CE_2 is LOW or \overline{CE}_3 is HIGH.

Timing Diagrams (continued)

Figure 7. Write Cycle Timing [26, 27]

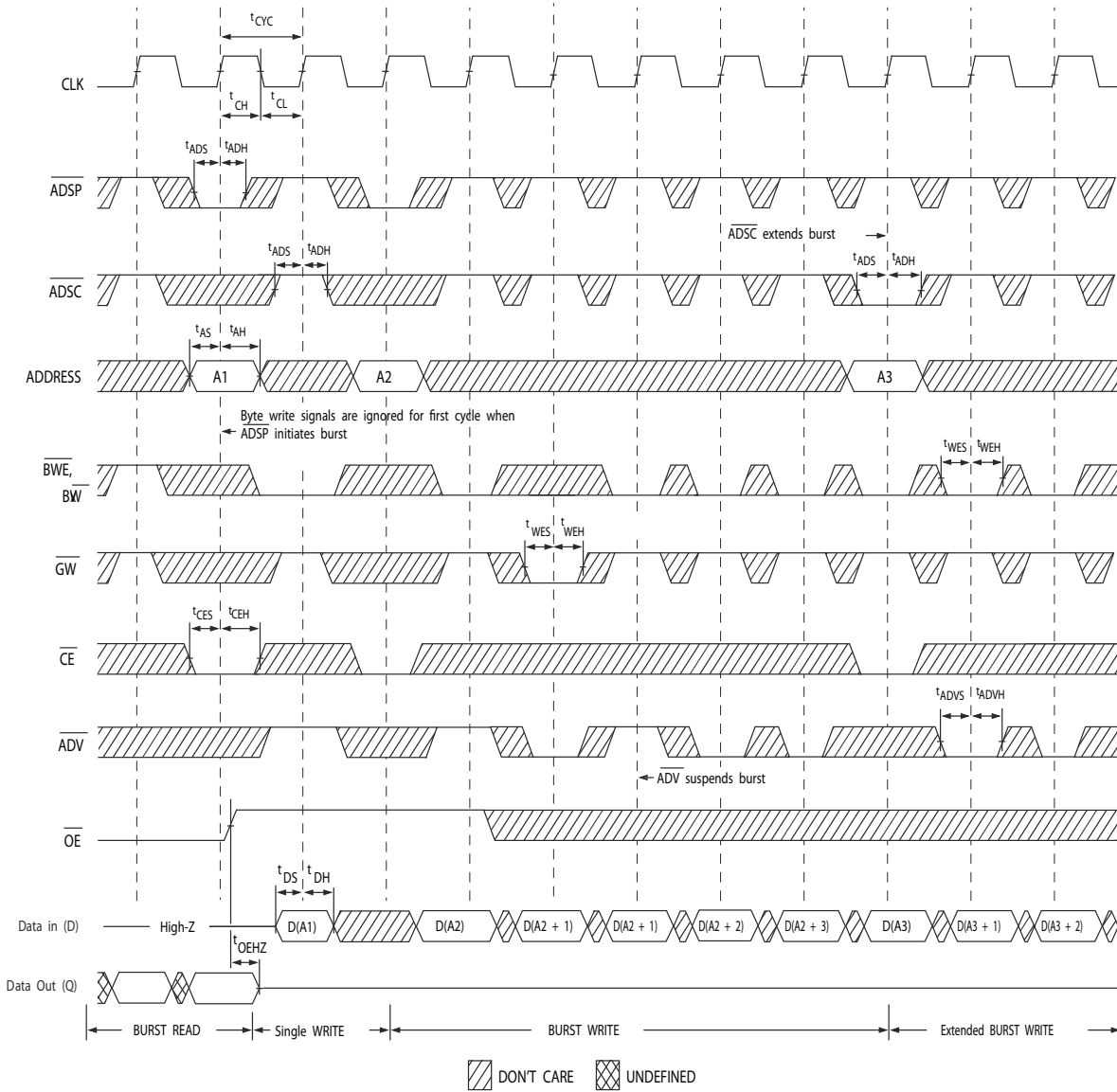

Notes

26. On this diagram, when \overline{CE} is LOW: \overline{CE}_1 is LOW, CE_2 is HIGH and \overline{CE}_3 is LOW. When \overline{CE} is HIGH: \overline{CE}_1 is HIGH or CE_2 is LOW or \overline{CE}_3 is HIGH.
 27. Full width write can be initiated by either \overline{GW} LOW; or by \overline{GW} HIGH, \overline{BWE} LOW and \overline{BW}_X LOW.

Timing Diagrams (continued)

Figure 8. Read/Write Cycle Timing [28, 29, 30]

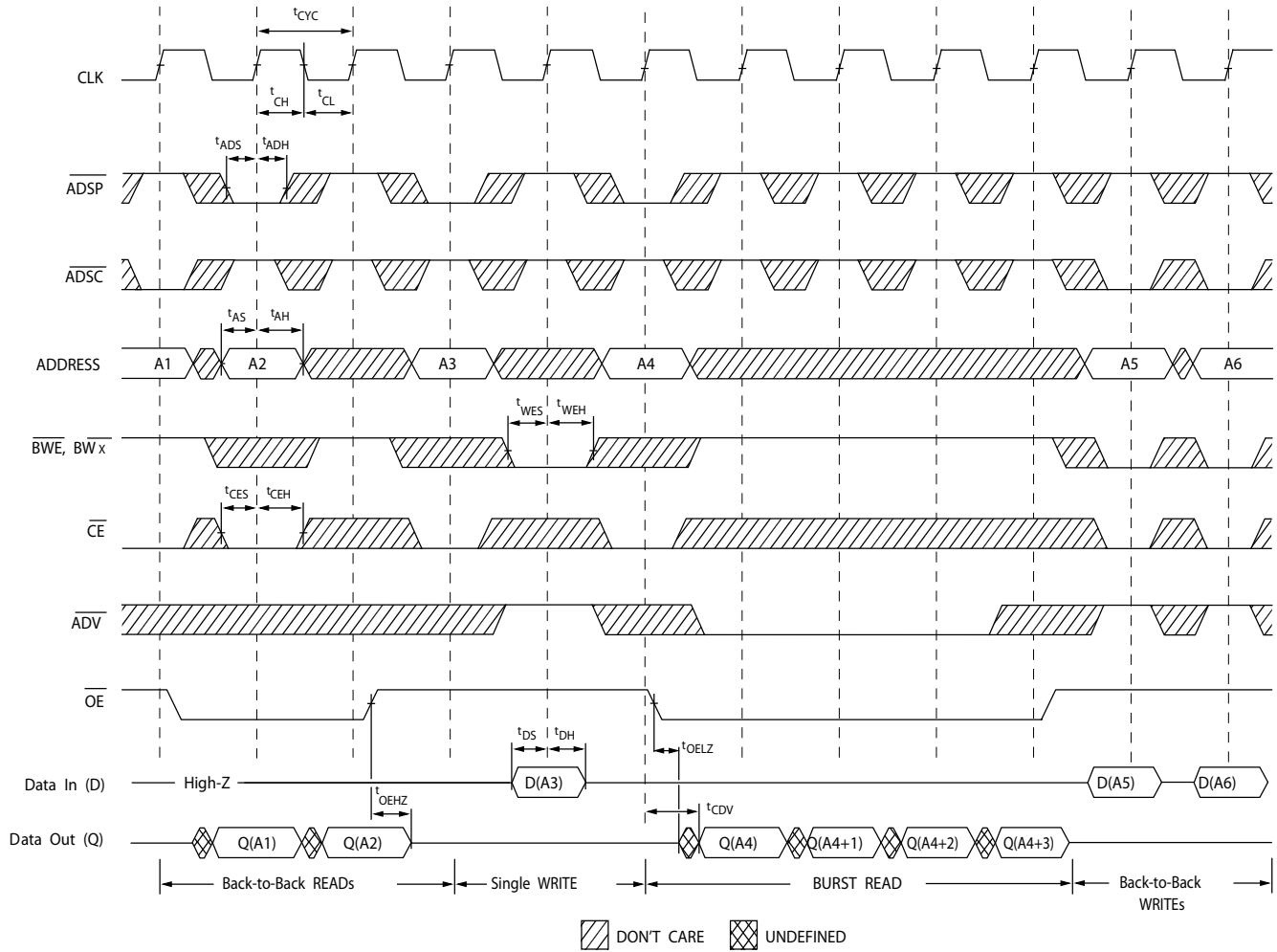

Notes

- 28. On this diagram, when \overline{CE} is LOW: \overline{CE}_1 is LOW, CE_2 is HIGH and \overline{CE}_3 is LOW. When \overline{CE} is HIGH: \overline{CE}_1 is HIGH or CE_2 is LOW or \overline{CE}_3 is HIGH.
- 29. The data bus (Q) remains in high Z following a WRITE cycle, unless a new read access is initiated by ADSP or ADSC.
- 30. \overline{GW} is HIGH.

Timing Diagrams (continued)

Figure 9. ZZ Mode Timing [31, 32]

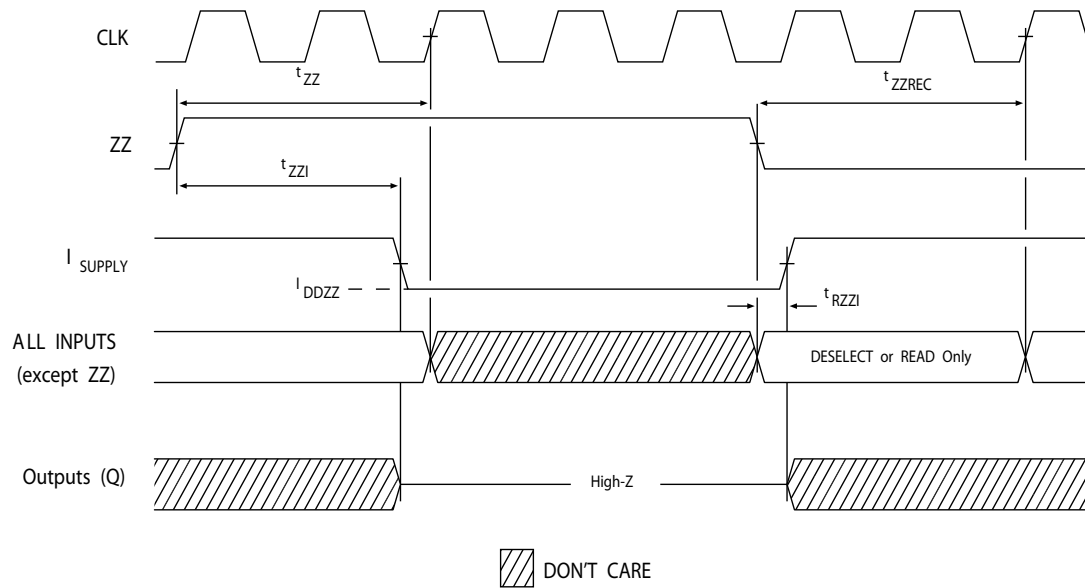

Notes

- 31. Device must be deselected when entering ZZ mode. See Cycle Descriptions table for all possible signal conditions to deselect the device.
- 32. DQs are in high Z when exiting ZZ sleep mode.

Package Diagrams (continued)

Figure 11. 165-ball FBGA ((13 × 15 × 1.4 mm) 0.5 Ball Diameter) Package Outline, 51-85180

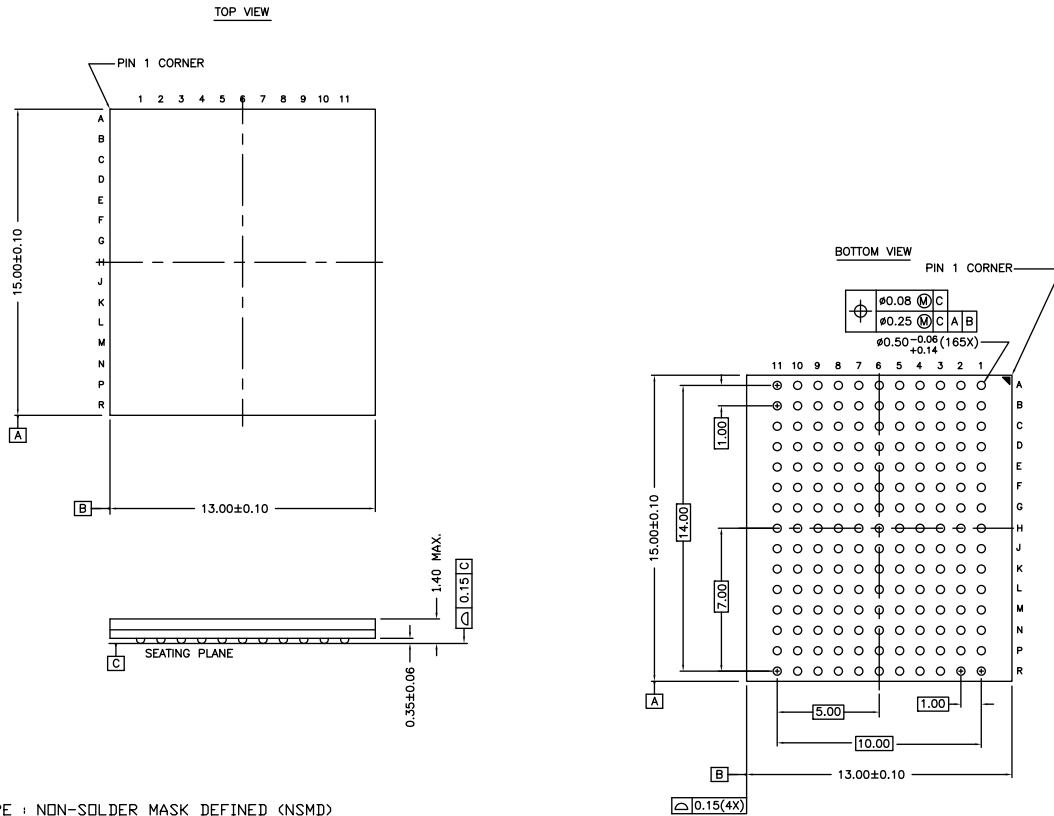

NOTES :
 SOLDER PAD TYPE : NON-SOLDER MASK DEFINED (NSMD)
 JEDEC REFERENCE : MO-216 / ISSUE E
 PACKAGE CODE : BB0AC/BW0AC
 PACKAGE WEIGHT : SEE CYPRESS PACKAGE MATERIAL DECLARATION
 DATASHEET (PMDD) POSTED ON THE CYPRESS WEB.

51-85180 *G

Acronyms

Acronym	Description
BGA	Ball Grid Array
CMOS	Complementary Metal Oxide Semiconductor
\overline{CE}	Chip Enable
EIA	Electronic Industries Alliance
FBGA	Fine-Pitch Ball Grid Array
I/O	Input/Output
JEDEC	Joint Electron Devices Engineering Council
JTAG	Joint Test Action Group
LMBU	Logical Multi-Bit Upsets
LSB	Least Significant Bit
LSBU	Logical Single-Bit Upsets
MSB	Most Significant Bit
\overline{OE}	Output Enable
PBGA	Plastic Ball Grid Array
SEL	Single Event Latch up
SRAM	Static Random Access Memory
TAP	Test Access Port
TCK	Test Clock
TDI	Test Data-In
TDO	Test Data-Out
TMS	Test Mode Select
TQFP	Thin Quad Flat Pack
TTL	Transistor-Transistor Logic

Document Conventions

Units of Measure

Symbol	Unit of Measure
°C	degree Celsius
MHz	megahertz
μA	microampere
mA	milliampere
mm	millimeter
ms	millisecond
mV	millivolt
ns	nanosecond
Ω	ohm
%	percent
pF	picofarad
V	volt
W	watt

Document History Page

Document Title: CY7C1361C/CY7C1363C, 9-Mbit (256K × 36/512K × 18) Flow-Through SRAM				
Document Number: 38-05541				
Rev.	ECN No.	Orig. of Change	Submission Date	Description of Change
**	241690	RKF	07/12/2004	New data sheet.
*A	278969	RKF	10/18/2004	Updated Boundary Scan Order (Changed to match the B rev of these devices). Updated Boundary Scan Order (Changed to match the B rev of these devices).
*B	332059	PCI	03/11/2005	Updated Features (Removed 117 MHz frequency related information). Updated Selection Guide (Removed 117 MHz frequency related information). Updated Pin Configurations (Address expansion pins/balls in the pinouts for all packages are modified as per JEDEC standard). Updated Pin Definitions (Added Address Expansion pins). Updated Functional Overview (Updated ZZ Mode Electrical Characteristics (Changed maximum value of I _{DDZZ} parameter from 35 mA to 50 mA)). Updated Identification Register Definitions (Split Device Width (23:18) into two rows; retained the same values for 165-ball FBGA; Changed Device Width (23:18) for 119-ball BGA from 000001 to 101001). Updated Electrical Characteristics (Updated Test Conditions of V _{OH} , V _{OL} parameters; changed maximum value of I _{SB1} parameter from 40 mA to 110 mA; changed maximum value of I _{SB3} parameter from 40 mA to 100 mA respectively; changed Test Condition of I _{SB4} parameter from (V _{IN} ≥ V _{DD} - 0.3 V or V _{IN} ≤ 0.3 V) to (V _{IN} ≥ V _{IH} or V _{IN} ≤ V _{IL}); removed 117 MHz frequency related information). Updated Thermal Resistance (Changed value of θ_{JA} and θ_{JC} parameters for 100-pin TQFP Package from 25 °C/W and 9 °C/W to 29.41 °C/W and 6.13 °C/W respectively; changed value of θ_{JA} and θ_{JC} for 119-ball BGA Package from 25 °C/W and 6 °C/W to 34.1 °C/W and 14.0 °C/W respectively; changed value of θ_{JA} and θ_{JC} for 165-ball FBGA Package from 27 °C/W and 6 °C/W to 16.8 °C/W and 3.0 °C/W respectively). Updated Switching Characteristics (Removed 117 MHz frequency related information). Updated Ordering Information (Updated part numbers (Added lead-free information for 100-pin TQFP, 119-ball BGA and 165-ball FBGA packages)).
*C	377095	PCI	06/10/2005	Updated Electrical Characteristics (Updated Note 17 (Modified test condition from V _{IH} ≤ V _{DD} to V _{IH} < V _{DD}); changed maximum value of I _{SB2} parameter from 30 mA to 40 mA).
*D	408298	RXU	11/16/2005	Changed address of Cypress Semiconductor Corporation from "3901 North First Street" to "198 Champion Court". Replaced three-state with tri-state in all instances across the document. Updated Electrical Characteristics (Changed "Input Load Current except ZZ and MODE" to "Input Leakage Current except ZZ and MODE" in the description of I _X parameter). Updated Ordering Information (Updated part numbers; replaced Package Name column with Package Diagram in the Ordering Information table). Updated Package Diagrams : spec 51-85180 – Changed revision from ** to *A. Updated to new template.
*E	433033	NXR	03/16/2006	Updated Features (Included Automotive Temperature Range). Updated Selection Guide (Included Automotive Temperature Range). Updated Functional Overview (Updated ZZ Mode Electrical Characteristics (Included Automotive Temperature Range)). Updated Operating Range (Included Automotive Temperature Range). Updated Electrical Characteristics (Included Automotive Temperature Range). Updated Ordering Information (Updated part numbers). Updated Package Diagrams : spec 51-85050 – Changed revision from *A to *B.

Document History Page (continued)

Document Title: CY7C1361C/CY7C1363C, 9-Mbit (256K × 36/512K × 18) Flow-Through SRAM Document Number: 38-05541				
Rev.	ECN No.	Orig. of Change	Submission Date	Description of Change
*F	501793	VKN	09/13/2006	Updated TAP AC Switching Characteristics (Changed minimum value of t_{TH} and t_{TL} parameters from 25 ns to 20 ns; and maximum value of t_{TDOV} parameter from 5 ns to 10 ns). Updated Maximum Ratings (Added the Maximum Rating for Supply Voltage on V_{DDQ} Relative to GND). Updated Ordering Information : Updated part numbers.
*G	2756340	VKN / AESA	08/26/2009	Added Neutron Soft Error Immunity . Updated Ordering Information (Updated part numbers; and modified the disclaimer for the Ordering information). Updated Package Diagrams : spec 51-85180 – Changed revision from *A to *B. Updated to new template.
*H	3036754	NJY	09/23/2010	Updated Ordering Information : No change in part numbers. Added Ordering Code Definitions . Updated Package Diagrams : spec 51-85050 – Changed revision from *B to *C. spec 51-85115 – Changed revision from *B to *C. spec 51-85180 – Changed revision from *B to *C. Added Acronyms and Units of Measure . Minor edits. Updated to new template. Completing Sunset Review.
*I	3050869	NJY	10/07/2010	Updated Ordering Information (Updated part numbers).
*J	3096309	NJY	11/28/2010	Updated Pin Definitions .
*K	3367594	PRIT	09/09/2011	Updated Package Diagrams : spec 51-85050 – Changed revision from *C to *D. Updated to new template. Completing Sunset Review.
*L	3612494	PRIT	05/09/2012	Updated Functional Description (Removed the Note “For best-practices recommendations, refer to the Cypress application note <i>System Design Guidelines</i> on www.cypress.com .” and its reference). Updated Pin Configurations (Removed 165-ball FBGA Package related information; updated Figure 3 (Removed CY7C1363C related information)). Updated IEEE 1149.1 Serial Boundary Scan (JTAG) (Removed CY7C1363C related information). Updated Identification Register Definitions (Removed CY7C1363C related information; removed 165-ball FBGA Package related information). Updated Scan Register Sizes (Removed “Bit Size (× 18)” column; removed 165-ball FBGA Package related information). Updated Boundary Scan Order (Removed CY7C1363C related information). Removed Boundary Scan Order (Corresponding to 165-ball FBGA Package). Updated Capacitance (Removed 165-ball FBGA Package related information). Updated Thermal Resistance (Removed 165-ball FBGA Package related information). Updated Package Diagrams : Removed spec 51-85180 *C.
*M	3753416	PRIT	09/24/2012	Updated Package Diagrams : spec 51-85115 – Changed revision from *C to *D. Completing Sunset Review.

Document History Page *(continued)*

Document Title: CY7C1361C/CY7C1363C, 9-Mbit (256K × 36/512K × 18) Flow-Through SRAM				
Document Number: 38-05541				
Rev.	ECN No.	Orig. of Change	Submission Date	Description of Change
*N	4112732	PRIT	09/03/2013	Updated Ordering Information (Updated part numbers). Updated to new template. Completing Sunset Review.
*O	4430353	PRIT	07/08/2014	Updated Features : Included 165-ball FBGA Package related information. Updated Pin Configurations : Included 165-ball FBGA Package related information (Added Figure 4). Added Boundary Scan Order (Corresponding to 165-ball FBGA Package). Updated Capacitance : Included 165-ball FBGA Package related information. Updated Thermal Resistance : Included 165-ball FBGA Package related information. Updated Ordering Information (Updated part numbers). Updated Package Diagrams : spec 51-85050 – Changed revision from *D to *E. Added spec 51-85180 *F.
*P	4574263	PRIT	11/19/2014	Updated Functional Description : Added “For a complete list of related documentation, click here .” at the end.
*Q	4973995	PRIT	10/19/2015	Updated Package Diagrams : spec 51-85180 – Changed revision from *F to *G. Updated to new template. Completing Sunset Review.
*R	5331538	PRIT	06/30/2016	Updated Truth Table : Updated details in “CE ₃ ” column corresponding to “Deselected cycle, power-down”. Updated to new template.
*S	5515297	PRIT	11/09/2016	Updated Ordering Information : No change in part numbers. Added a column “Status” and added MPN status details in that column. Added Note “This MPN is not recommended for new designs.” and referred the same note in MPN “CY7C1363C-133AJX1”. Updated Package Diagrams : spec 51-85050 – Changed revision from *E to *F. Removed spec 51-85115 *D. Updated to new template. Completing Sunset Review.
*T	6026123	RMES	01/11/2018	Updated Ordering Information : Updated part numbers. Removed Note “This MPN is not recommended for new designs.” and its reference. Updated Package Diagrams : spec 51-85050 – Changed revision from *F to *G. Updated to new template. Completing Sunset Review.
*U	6524559	RMES	03/28/2019	Updated Ordering Information : Updated part numbers. Updated to new template.

Sales, Solutions, and Legal Information

Worldwide Sales and Design Support

Cypress maintains a worldwide network of offices, solution centers, manufacturer's representatives, and distributors. To find the office closest to you, visit us at [Cypress Locations](#).

Products

Arm [®] Cortex [®] Microcontrollers	cypress.com/arm
Automotive	cypress.com/automotive
Clocks & Buffers	cypress.com/clocks
Interface	cypress.com/interface
Internet of Things	cypress.com/iot
Memory	cypress.com/memory
Microcontrollers	cypress.com/mcu
PSoC	cypress.com/psoc
Power Management ICs	cypress.com/pmic
Touch Sensing	cypress.com/touch
USB Controllers	cypress.com/usb
Wireless Connectivity	cypress.com/wireless

PSoC[®] Solutions

[PSoC 1](#) | [PSoC 3](#) | [PSoC 4](#) | [PSoC 5LP](#) | [PSoC 6 MCU](#)

Cypress Developer Community

[Community](#) | [Projects](#) | [Video](#) | [Blogs](#) | [Training](#) | [Components](#)

Technical Support

cypress.com/support



© Cypress Semiconductor Corporation, 2004–2019. This document is the property of Cypress Semiconductor Corporation and its subsidiaries ("Cypress"). This document, including any software or firmware included or referenced in this document ("Software"), is owned by Cypress under the intellectual property laws and treaties of the United States and other countries worldwide. Cypress reserves all rights under such laws and treaties and does not, except as specifically stated in this paragraph, grant any license under its patents, copyrights, trademarks, or other intellectual property rights. If the Software is not accompanied by a license agreement and you do not otherwise have a written agreement with Cypress governing the use of the Software, then Cypress hereby grants you a personal, non-exclusive, nontransferable license (without the right to sublicense) (1) under its copyright rights in the Software (a) for Software provided in source code form, to modify and reproduce the Software solely for use with Cypress hardware products, only internally within your organization, and (b) to distribute the Software in binary code form externally to end users (either directly or indirectly through resellers and distributors), solely for use on Cypress hardware product units, and (2) under those claims of Cypress's patents that are infringed by the Software (as provided by Cypress, unmodified) to make, use, distribute, and import the Software solely for use with Cypress hardware products. Any other use, reproduction, modification, translation, or compilation of the Software is prohibited.

TO THE EXTENT PERMITTED BY APPLICABLE LAW, CYPRESS MAKES NO WARRANTY OF ANY KIND, EXPRESS OR IMPLIED, WITH REGARD TO THIS DOCUMENT OR ANY SOFTWARE OR ACCOMPANYING HARDWARE, INCLUDING, BUT NOT LIMITED TO, THE IMPLIED WARRANTIES OF MERCHANTABILITY AND FITNESS FOR A PARTICULAR PURPOSE. No computing device can be absolutely secure. Therefore, despite security measures implemented in Cypress hardware or software products, Cypress shall have no liability arising out of any security breach, such as unauthorized access to or use of a Cypress product. CYPRESS DOES NOT REPRESENT, WARRANT, OR GUARANTEE THAT CYPRESS PRODUCTS, OR SYSTEMS CREATED USING CYPRESS PRODUCTS, WILL BE FREE FROM CORRUPTION, ATTACK, VIRUSES, INTERFERENCE, HACKING, DATA LOSS OR THEFT, OR OTHER SECURITY INTRUSION (collectively, "Security Breach"). Cypress disclaims any liability relating to any Security Breach, and you shall and hereby do release Cypress from any claim, damage, or other liability arising from any Security Breach. In addition, the products described in these materials may contain design defects or errors known as errata which may cause the product to deviate from published specifications. To the extent permitted by applicable law, Cypress reserves the right to make changes to this document without further notice. Cypress does not assume any liability arising out of the application or use of any product or circuit described in this document. Any information provided in this document, including any sample design information or programming code, is provided only for reference purposes. It is the responsibility of the user of this document to properly design, program, and test the functionality and safety of any application made of this information and any resulting product. "High-Risk Device" means any device or system whose failure could cause personal injury, death, or property damage. Examples of High-Risk Devices are weapons, nuclear installations, surgical implants, and other medical devices. "Critical Component" means any component of a High-Risk Device whose failure to perform can be reasonably expected to cause, directly or indirectly, the failure of the High-Risk Device, or to affect its safety or effectiveness. Cypress is not liable, in whole or in part, and you shall and hereby do release Cypress from any claim, damage, or other liability arising from any use of a Cypress product as a Critical Component in a High-Risk Device. You shall indemnify and hold Cypress, its directors, officers, employees, agents, affiliates, distributors, and assigns harmless from and against all claims, costs, damages, and expenses, arising out of any claim, including claims for product liability, personal injury or death, or property damage arising from any use of a Cypress product as a Critical Component in a High-Risk Device. Cypress products are not intended or authorized for use as a Critical Component in any High-Risk Device except to the limited extent that (i) Cypress's published data sheet for the product explicitly states Cypress has qualified the product for use in a specific High-Risk Device, or (ii) Cypress has given you advance written authorization to use the product as a Critical Component in the specific High-Risk Device and you have signed a separate indemnification agreement.

Cypress, the Cypress logo, Spansion, the Spansion logo, and combinations thereof, WICED, PSoC, CapSense, EZ-USB, F-RAM, and Traveo are trademarks or registered trademarks of Cypress in the United States and other countries. For a more complete list of Cypress trademarks, visit cypress.com. Other names and brands may be claimed as property of their respective owners.

Looking for pricing, stock, or lifecycle information?

Click below to explore more details on WIN SOURCE:

-  [View CY7C1361C-133AXCT on WIN SOURCE](#)
-  [Cypress Semiconductor Corp Information](#)

Optimize Your Supply Chain with WIN SOURCE Solutions

-  Global Sourcing Solution
-  Obsolete Management
-  Cost Control Management
-  Shortage Management
-  Alternative Solution
-  Excess Inventory Management