



Micro ISO
1 Form C type



Micro ISO
1 Form A type

RoHS compliant

FEATURES

- **Low profile:**
22.5 mm(L)×15 mm(W)×15.7 mm(H)
.886 inch(L)×.591 inch(W)×.618 inch(H)
- **Low temperature rise**
Terminal temperature has been reduced compared with using our conventional product
- **Low sound pressure level**
Noise level has been reduced approx. 10dB compared with using our conventional product.
- **Wide line-up**
Micro ISO terminal types and resistor inside type.
- **Plastic sealed type**
Plastically sealed for automatic cleaning.
- **Compact and high-capacity 20A load switching**
N.O.: 20A 14V DC, N.C.: 10A 14V DC
(Max. carrying current: at 85°C 185°F)

TYPICAL APPLICATIONS

- Headlights
- Magnetic clutches
- Radiator fans
- Blowers
- Fog lamps
- Tail lights
- Heaters
- Defoggers
- Horns
- Condenser fans, etc.

ORDERING INFORMATION

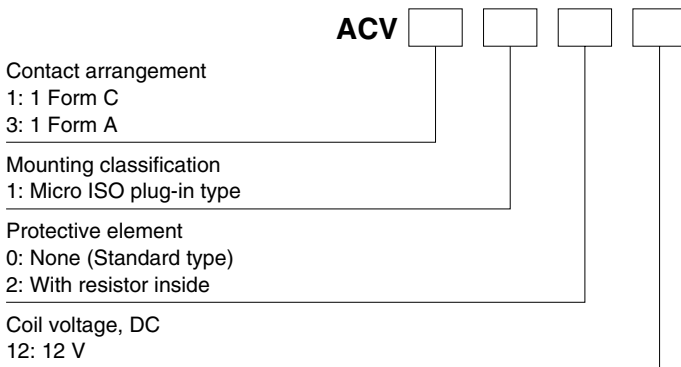

TYPES

Contact arrangement	Coil voltage	Protective construction	Mounting classification	Part No.
1 Form A	12 V DC	Sealed type	Micro ISO plug-in type	ACV31012
1 Form C			Micro ISO plug-in type	ACV11012

Note: Please use "ACV**212" to order built-in resistor type. (Asterisks " * " should be filled in from ORDERING INFORMATION.)
Standard packing: Carton: 50 pcs.; Case: 200 pcs.

RATING

1. Coil data

Nominal coil voltage	Pick-up voltage* (at 20°C 68°F)	Drop-out voltage (at 20°C 68°F)	Nominal operating current [±10%] (at 20°C 68°F)	Coil resistance [±10%] (at 20°C 68°F)	Nominal operating power (at 20°C 68°F)	Usable voltage range (at 85°C 185°F)
12V DC	Max. 7.0 V DC (Initial)	Min. 0.6 V DC (Initial)	67 mA, 84 mA (with resistor)	180Ω, 142.3Ω (with resistor)	0.8 W, 1.0 W (with resistor)	10 to 16V DC

Note: * Other pick-up voltage types are also available. Please contact us for details.

2. Specifications

Characteristics	Item	Specifications	
		1 Form A	1 Form C
Contact	Arrangement	Typ 3mΩ (By voltage drop 6V DC 1A)	
	Contact resistance (Initial)	N.O.: Max. 0.2 V (By voltage drop 14 V DC 20 A) N.C.: Max. 0.5 V (By voltage drop 14 V DC 10 A)	
	Contact voltage drop (after electrical life test)	Ag alloy (Cadmium free)	
	Contact material	N.O.: 20 A 14V DC N.C.: 20 A 14V DC, N.C.: 10 A 14V DC	
Rating	Nominal switching capacity (resistive load)	0.8 W, 1.0 W (built-in resistor type)	
	Max. carrying current (at 85°C 185°F, continuous)	1 A 12V DC	
	Nominal operating power	N.O.: 20 A 14V DC N.C.: 20 A 14V DC N.C.: 10 A 14V DC	
	Min. switching capacity (resistive load)*1	N.O.: 20 A 14V DC	
Electrical characteristics	Insulation resistance (Initial)	Min. 20 MΩ (at 500V DC)	
	Breakdown voltage (Initial)	Between open contacts	500 Vrms for 1 min. (Detection current: 10mA)
		Between contacts and coil	500 Vrms for 1 min. (Detection current: 10mA)
	Operate time (at nominal voltage) (at 20°C 68°F)	Max. 10ms (excluding contact bounce time) (Initial)	
	Release time (at nominal voltage) (at 20°C 68°F)	Max. 10ms (excluding contact bounce time) (Initial)	
Mechanical characteristics	Shock resistance	Functional	Min. 100 m/s ² {10G} (Half-wave pulse of sine wave: 11ms; detection time: 10μs)
		Destructive	Min. 1,000 m/s ² {100G} (Half-wave pulse of sine wave: 6ms)
	Vibration resistance	Functional	10 Hz to 100 Hz, Min. 44.1 m/s ² {4.5G} (Detection time: 10μs)
		Destructive	10 Hz to 500 Hz, Min. 44.1 m/s ² {4.5G}, Time of vibration for each direction; X, Y, Z direction: 4 hours
Expected life	Mechanical	Min. 10 ⁶ (at 120 cpm)	
	Electrical (at nominal switching capacity)	Min. 10 ⁵ (operating frequency: 2s ON, 2s OFF)	
Conditions	Conditions for operation, transport and storage*2	Ambient temperature: -40°C to +85°C -40°F to +185°F*3, Humidity: 5% R.H. to 85% R.H. (Not freezing and condensing at low temperature), air pressure: 86 to 106kPa	
Mass		Approx. 15 g .53 oz	

Notes: *1. This value can change due to the switching frequency, environmental conditions, and desired reliability level, therefore it is recommended to check this with the actual load.

*2. The upper operation ambient temperature limit is the maximum temperature that can satisfy the coil temperature rise value. Please refer to "Usage ambient condition" in CAUTIONS FOR USE OF AUTOMOTIVE RELAYS.

*3. Please inquire if you will be using the relay in a high temperature atmosphere.

* Regarding solder, this product is not MIL (Military Standard) compliant. Please evaluate solder mounting by the actual equipment before using.

REFERENCE DATA

1. Coil temperature rise (20A)

Point measured: Inside the coil
Contact carrying current: 20A
Coil applied voltage: 13.5V

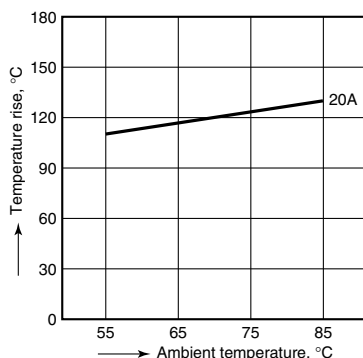

2. Distribution of pick-up and drop-out voltage

Sample: ACV11012, 100pcs

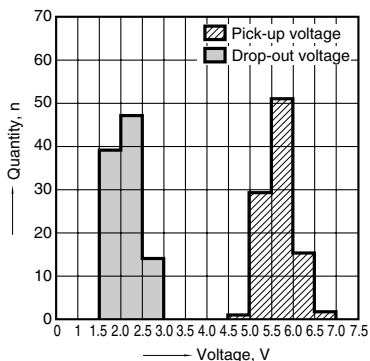

3. Distribution of operate and release time

Sample: ACV11012, 100pcs.

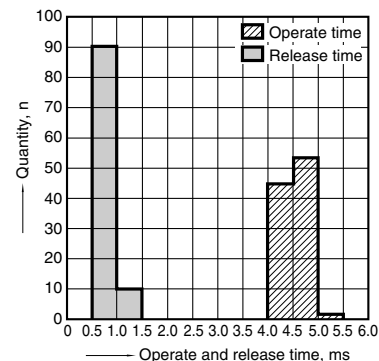

4. Ambient temperature and operating voltage range

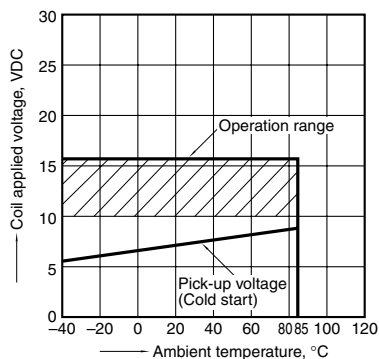

CV (ACV)

5-(1). Electrical life test (Resistive load)

Sample: ACV11012, 3pcs.
 Load: Resistive load (NC switching) 10A
 Switching frequency: ON 1s, OFF 1s
 Ambient temperature: Room temperature

Circuit

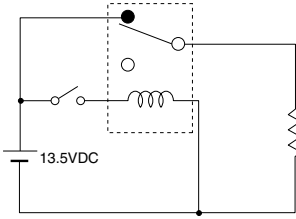

Change of pick-up and drop-out voltage

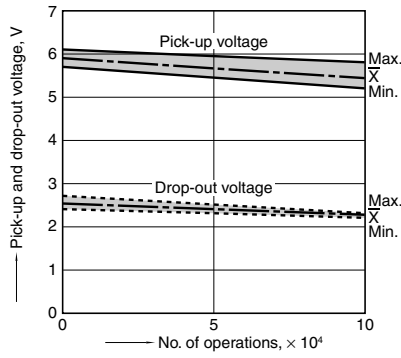

Change of contact resistance

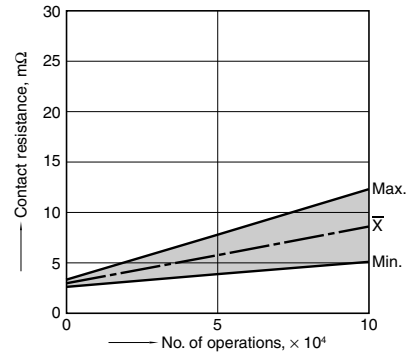

Load current waveform

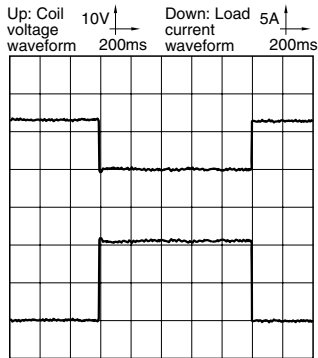

5-(2). Electrical life test (Lamp load)

Sample: ACV31212, 3pcs.
 Load: 55Wx4, inrush: 90A/steady: 20A,
 lamp actual load
 Switching frequency: ON 1s, OFF 14s
 Ambient temperature: Room temperature

Circuit

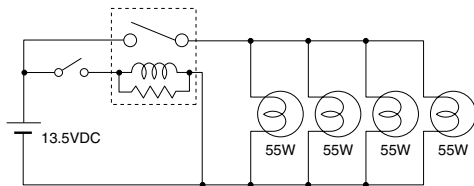

Change of pick-up and drop-out voltage

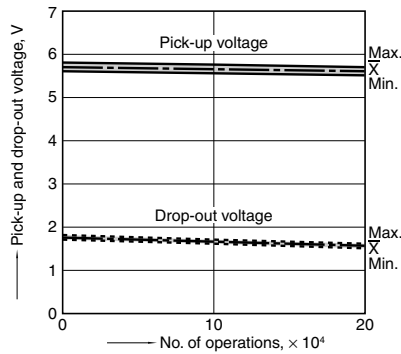

Change of contact resistance

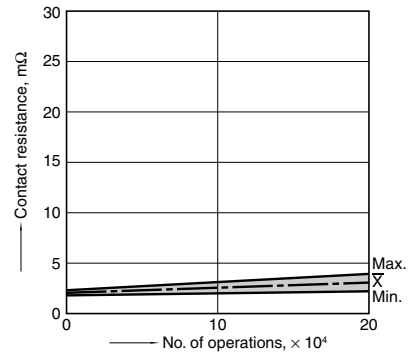

Load current waveform

Inrush current: 90A, steady current: 20A

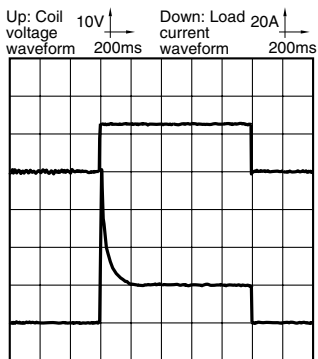

5-(3). Electrical life test (Motor load)

Sample: ACV31212, 3pcs.
 Load: inrush: 80A/steady: 18A,
 radiator fan actual load (motor free)
 Switching frequency: ON 2s, OFF 6s
 Ambient temperature: Room temperature

Circuit

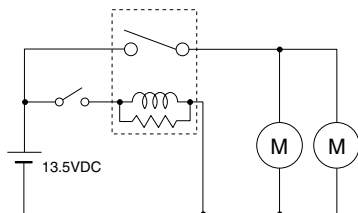

Change of pick-up and drop-out voltage

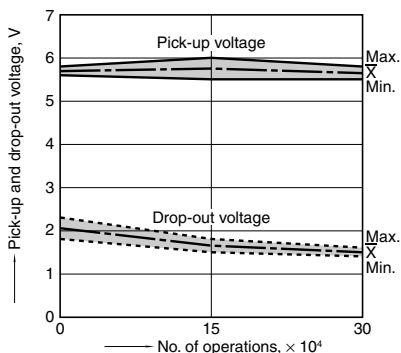

Change of contact resistance

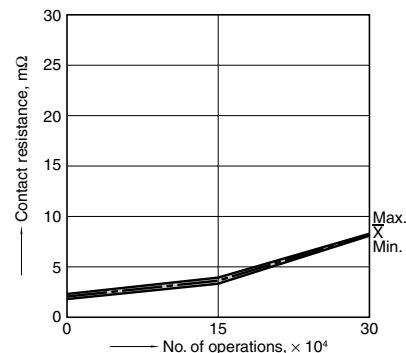

Load current waveform

Inrush current: 80A, steady current: 18A

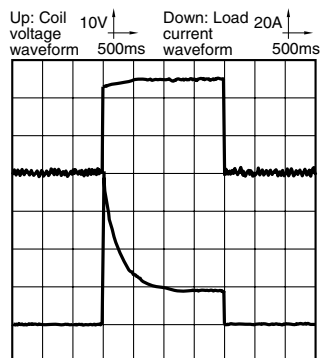

DIMENSIONS (mm inch)

The CAD data of the products with a **CAD Data** mark can be downloaded from: <http://industrial.panasonic.com/ac/e/>

1. Micro ISO plug-in type

CAD Data



External dimensions

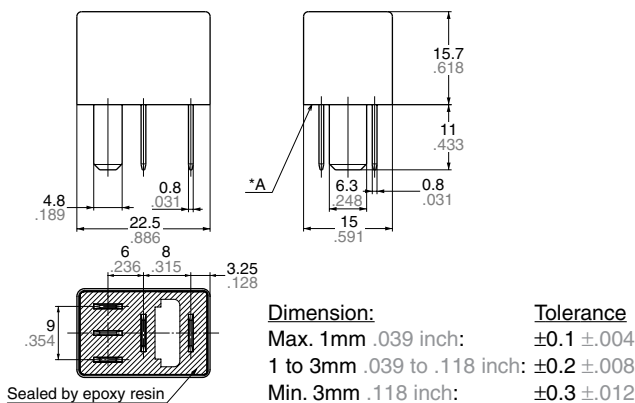

Schematic (Bottom view)

1 Form A

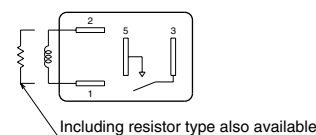

1 Form C

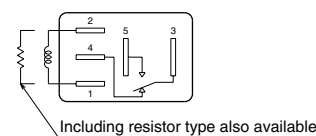



Note: Intervals between terminals is measured at A surface level.

For Cautions for Use, see Relay Technical Information.

Looking for pricing, stock, or lifecycle information?

Click below to explore more details on WIN SOURCE:

-  [View ACV11112](#) on WIN SOURCE
-  [Panasonic](#) Information

Optimize Your Supply Chain with WIN SOURCE Solutions

-  Global Sourcing Solution
-  Obsolete Management
-  Cost Control Management
-  Shortage Management
-  Alternative Solution
-  Excess Inventory Management