





Parameter	Rating	Units
Breakdown Voltage - $BV_{CEO}$	350	$V_P$
Current Transfer Ratio - CTR	1000-8000	%

### Features

- $350V_P$  Breakdown Voltage
- $3750V_{rms}$  Input/Output Isolation
- Machine Insertable, Wave Solderable
- Surface Mount Tape & Reel Version Available

### Applications

- Telecom Switching
- Tip/Ring Circuits
- Hook Switch
- Modem Switching (Laptop, Notebook, Pocket Size)
- Loop Detect
- Ringing Detect
- Current Sensing

### Description

The CPC1302 is a dual optocoupler with two identical, independent channels, each having a unidirectional input and a high-voltage Darlington output. Light output from the highly efficient GaAlAs infrared LED activates its associated, optically coupled silicon NPN photo-Darlington output transistor. The input LED and the output transistor are separated by a  $3750V_{rms}$  isolation barrier.

With a LED current of only 1mA, a current transfer ratio of 1000% to 8000% is guaranteed at the collector of the 350V Darlington output transistor.

The CPC1302's low input current capability with high current transfer ratios, output voltage capability, and isolation barrier rating make it ideal for many applications such as telecom, industrial, and power control.

### Approvals

- UL 1577 Approved Component: File E76270
- CSA Certified Component: Certificate 1172007
- EN 60950 Certified Component:  
TUV Certificate B 10 05 49410 006

### Ordering Information

Part Number	Description
CPC1302G	8-Pin DIP (50/Tube)
CPC1302GS	8-Pin Surface Mount (50/Tube)
CPC1302GSTR	8-Pin Surface Mount (1000/Reel)

### Pin Configuration

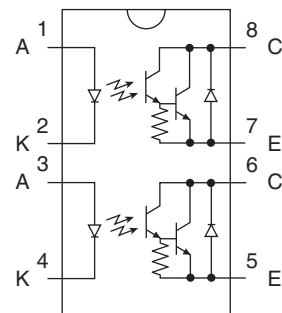

### Absolute Maximum Ratings @ 25°C

Parameter	Ratings	Units
Breakdown Voltage, $BV_{CEO}$	350	$V_P$
Reverse Input Voltage	5	V
Input Control Current	50	mA
Peak (10ms)	1	A
Input Power Dissipation <sup>1</sup> (Each)	150	mW
Phototransistor Power Dissipation <sup>2</sup> (Each)	150	mW
Isolation Voltage, Input to Output	3750	$V_{rms}$
Operational Temperature	-40 to +85	°C
Storage Temperature	-40 to +125	°C

<sup>1</sup> Derate linearly 1.33 mW / °C  
<sup>2</sup> Derate linearly 1.5 mW / °C

Absolute Maximum Ratings are stress ratings. Stresses in excess of these ratings can cause permanent damage to the device. Functional operation of the device at conditions beyond those indicated in the operational sections of this data sheet is not implied.

### Electrical Characteristics @ 25°C

Parameters	Conditions	Symbol	Min	Typ	Max	Units
<b>Output Characteristics</b>						
Phototransistor Breakdown Voltage	$I_{CEO}=100\mu A$	$BV_{CEO}$	350	-	-	$V_P$
Emitter-Collector Breakdown Voltage	$I_E=0.1mA$	$BV_{ECO}$	0.3	-	-	V
Phototransistor Output (Dark) Current	$V_{CEO}=200V, I_F=0mA$	$I_{CEO}$	-	-	100	nA
Saturation Voltage	$I_C=10mA, I_F=1mA$	$V_{CE(sat)}$	-	-	1	V
	$I_C=100mA, I_F=10mA$		-	-	1.2	V
Current Transfer Ratio	$I_F=1mA, V_{CE}=1V$	CTR	1000	5500	8000	%
Output Capacitance	$V_{CEO}=50V, f=1MHz$	$C_{OUT}$	-	13	-	pF
<b>Input Characteristics</b>						
Input Control Current	$I_C=10mA, V_{CE}=1V$	$I_F$	-	0.07	1	mA
Input Voltage Drop	$I_F=5mA$	$V_F$	0.9	1.2	1.4	V
Input Reverse Current	$V_R=5V$	$I_R$	-	-	10	$\mu A$
<b>Common Characteristics</b>						
Input to Output Capacitance	-	$C_{I/O}$	-	3	-	pF

### Switching Characteristics @ 25°C

Characteristic	Symbol	Test Condition	Typ	Units
Rise Time	$t_R$	$V_{CC}=10V$ $I_F=10mA$ $R_L=100\Omega$	40	$\mu s$
Fall Time	$t_F$		5	
Turn-On Time	$t_{on}$		5	
Storage Time	$t_S$		20	
Turn-Off Time	$t_{off}$		60	
Turn-On Time	$t_{on}$		$V_{CC}=10V$	
Storage Time	$t_S$	$I_F=16mA$	40	
Turn-Off Time	$t_{off}$	$R_L=180\Omega$	80	

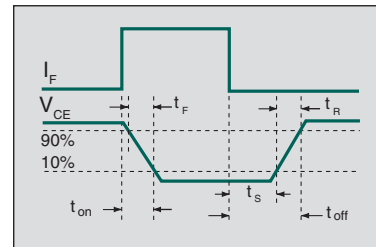

Switching Time Test Circuit

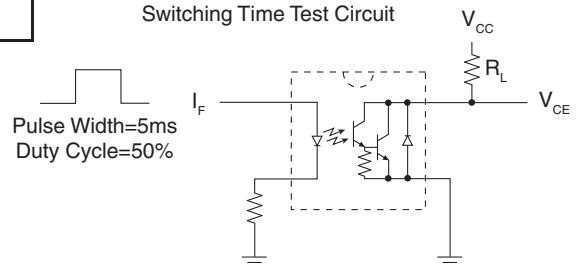

**PERFORMANCE DATA\***

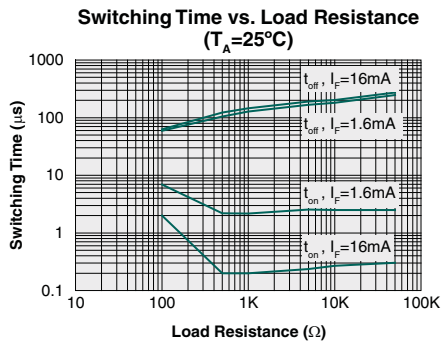
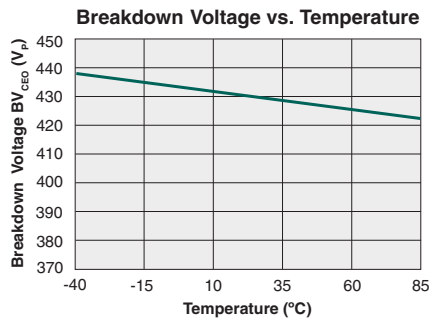
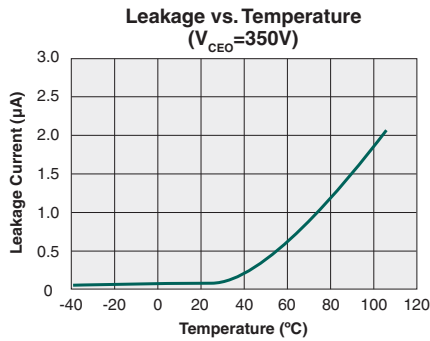
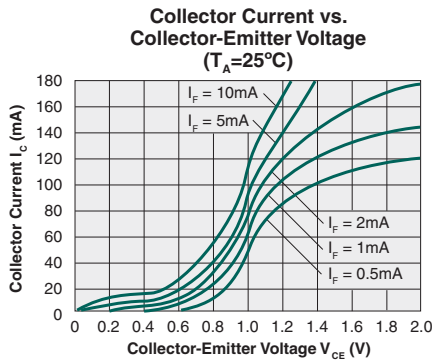
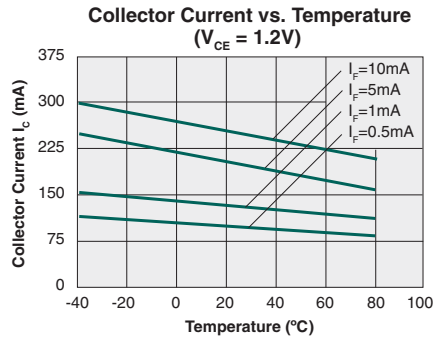
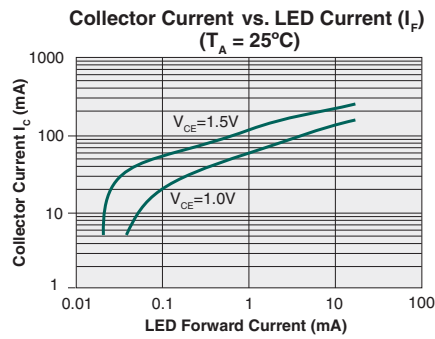
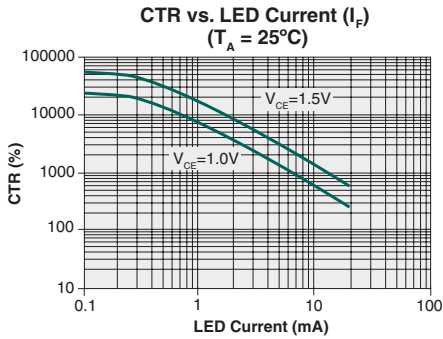
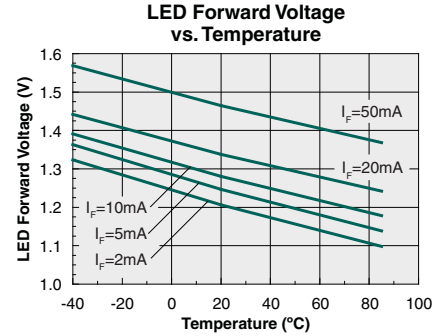
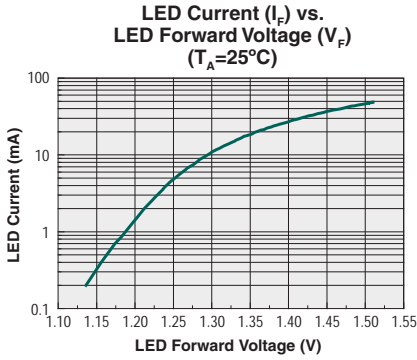
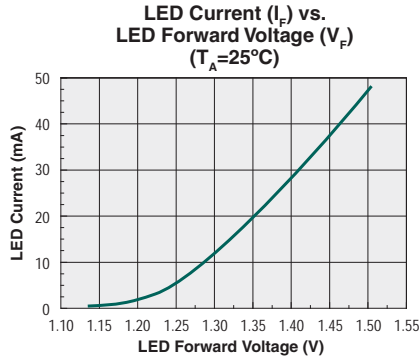

\*The Performance data shown in the graphs above is typical of device performance. For guaranteed parameters not indicated in the written specifications, please contact our application department.

## Manufacturing Information

### Moisture Sensitivity



All plastic encapsulated semiconductor packages are susceptible to moisture ingress. IXYS Integrated Circuits Division classified all of its plastic encapsulated devices for moisture sensitivity according to the latest version of the joint industry standard, **IPC/JEDEC J-STD-020**, in force at the time of product evaluation. We test all of our products to the maximum conditions set forth in the standard, and guarantee proper operation of our devices when handled according to the limitations and information in that standard as well as to any limitations set forth in the information or standards referenced below.

Failure to adhere to the warnings or limitations as established by the listed specifications could result in reduced product performance, reduction of operable life, and/or reduction of overall reliability.

This product carries a **Moisture Sensitivity Level (MSL) rating** as shown below, and should be handled according to the requirements of the latest version of the joint industry standard **IPC/JEDEC J-STD-033**.

Device	Moisture Sensitivity Level (MSL) Rating
CPC1302G / CPC1302GS	MSL 1

### ESD Sensitivity



This product is **ESD Sensitive**, and should be handled according to the industry standard **JESD-625**.

### Reflow Profile

This product has a maximum body temperature and time rating as shown below. All other guidelines of **J-STD-020** must be observed.

Device	Maximum Temperature x Time
CPC1302G / CPC1302GS	250°C for 30 seconds

### Board Wash

IXYS Integrated Circuits Division recommends the use of no-clean flux formulations. However, board washing to remove flux residue is acceptable. Since IXYS Integrated Circuits Division employs the use of silicone coating as an optical waveguide in many of its optically isolated products, the use of a short drying bake could be necessary if a wash is used after solder reflow processes. Chlorine- or Fluorine-based solvents or fluxes should not be used. Cleaning methods that employ ultrasonic energy should not be used.



**MECHANICAL DIMENSIONS**

**CPC1302G**

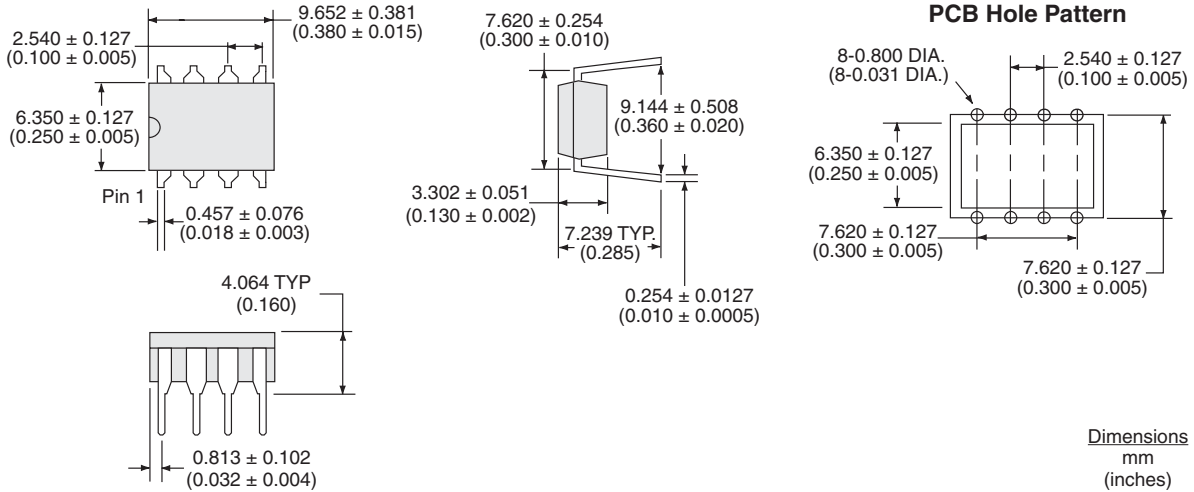

**CPC1302GS**

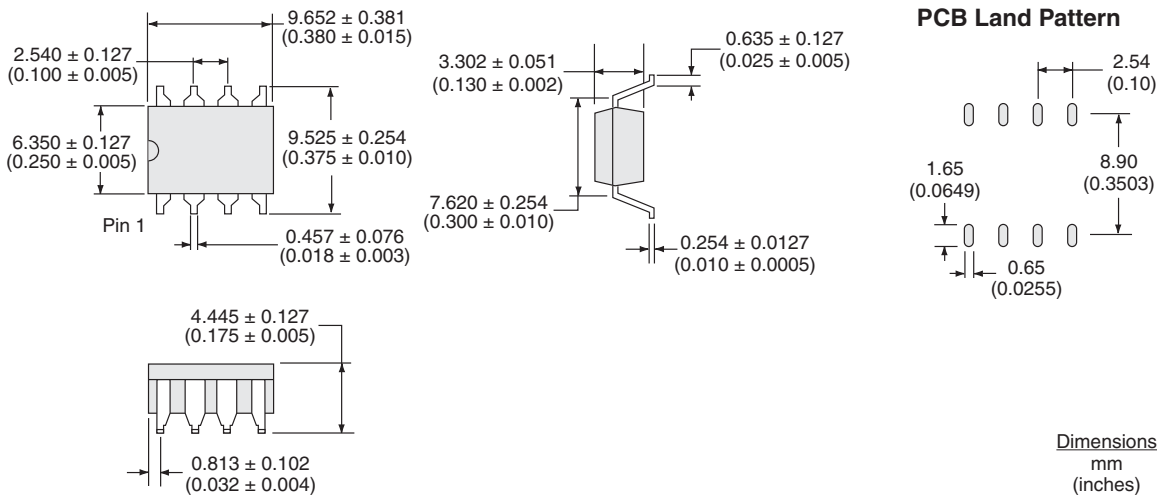

**MECHANICAL DIMENSIONS**

**CPC1302GSTR Tape & Reel**

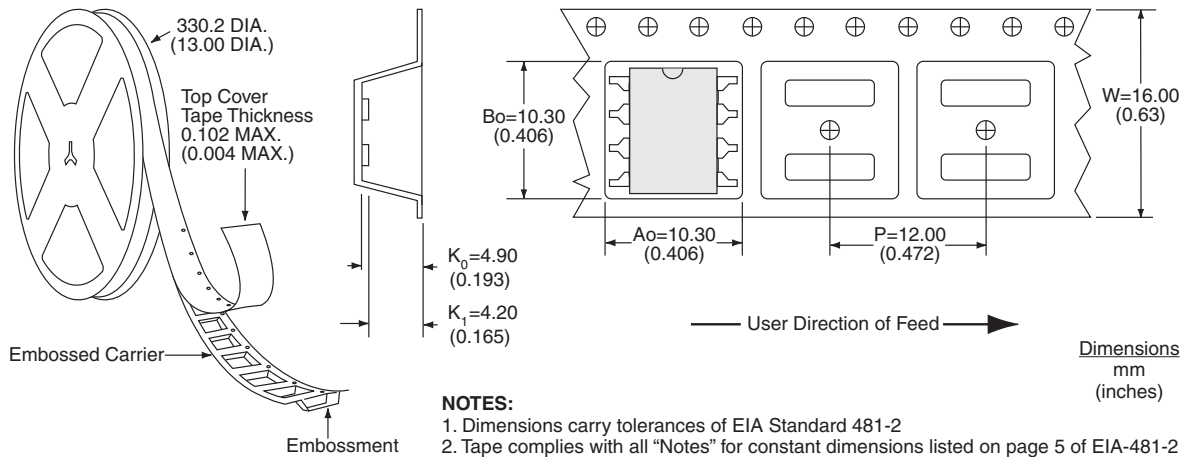

**For additional information please visit our website at: [www.ixysic.com](http://www.ixysic.com)**

IXYS Integrated Circuits Division makes no representations or warranties with respect to the accuracy or completeness of the contents of this publication and reserves the right to make changes to specifications and product descriptions at any time without notice. Neither circuit patent licenses nor indemnity are expressed or implied. Except as set forth in IXYS Integrated Circuits Division's Standard Terms and Conditions of Sale, IXYS Integrated Circuits Division assumes no liability whatsoever, and disclaims any express or implied warranty, relating to its products including, but not limited to, the implied warranty of merchantability, fitness for a particular purpose, or infringement of any intellectual property right.

The products described in this document are not designed, intended, authorized or warranted for use as components in systems intended for surgical implant into the body, or in other applications intended to support or sustain life, or where malfunction of IXYS Integrated Circuits Division's product may result in direct physical harm, injury, or death to a person or severe property or environmental damage. IXYS Integrated Circuits Division reserves the right to discontinue or make changes to its products at any time without notice.

## Looking for pricing, stock, or lifecycle information?

Click below to explore more details on WIN SOURCE:

 [View CPC1302GSTR on WIN SOURCE](#)

 [IXYS Information](#)

## Optimize Your Supply Chain with WIN SOURCE Solutions

-  Global Sourcing Solution
-  Obsolete Management
-  Cost Control Management
-  Shortage Management
-  Alternative Solution
-  Excess Inventory Management