



**THE DATASHEET OF
CD74HCT02M96**



Features

- **Buffered Inputs**
- **Typical Propagation Delay: 7ns at $V_{CC} = 5V$, $C_L = 15pF$, $T_A = 25^\circ C$**
- **Fanout (Over Temperature Range)**
 - Standard Outputs 10 LSTTL Loads
 - Bus Driver Outputs 15 LSTTL Loads
- **Wide Operating Temperature Range . . . $-55^\circ C$ to $125^\circ C$**
- **Balanced Propagation Delay and Transition Times**
- **Significant Power Reduction Compared to LSTTL Logic ICs**
- **HC Types**
 - 2V to 6V Operation
 - High Noise Immunity: $N_{IL} = 30\%$, $N_{IH} = 30\%$ of V_{CC} at $V_{CC} = 5V$
- **HCT Types**
 - 4.5V to 5.5V Operation
 - Direct LSTTL Input Logic Compatibility, $V_{IL} = 0.8V$ (Max), $V_{IH} = 2V$ (Min)
 - CMOS Input Compatibility, $I_I \leq 1\mu A$ at V_{OL} , V_{OH}

Description

The 'HC02 and 'HCT02 logic gates utilize silicon-gate CMOS technology to achieve operating speeds similar to LSTTL gates with the low power consumption of standard CMOS integrated circuits. All devices have the ability to drive 10 LSTTL loads. The HCT logic family is functionally pin compatible with the standard LS logic family.

Ordering Information

| PART NUMBER | TEMP. RANGE ($^\circ C$) | PACKAGE |
|--------------|----------------------------|--------------|
| CD54HC02F3A | -55 to 125 | 14 Ld CERDIP |
| CD54HCT02F3A | -55 to 125 | 14 Ld CERDIP |
| CD74HC02E | -55 to 125 | 14 Ld PDIP |
| CD74HC02M | -55 to 125 | 14 Ld SOIC |
| CD74HC02MT | -55 to 125 | 14 Ld SOIC |
| CD74HC02M96 | -55 to 125 | 14 Ld SOIC |
| CD74HCT02E | -55 to 125 | 14 Ld PDIP |
| CD74HCT02M | -55 to 125 | 14 Ld SOIC |
| CD74HCT02MT | -55 to 125 | 14 Ld SOIC |
| CD74HCT02M96 | -55 to 125 | 14 Ld SOIC |

NOTE: When ordering, use the entire part number. The suffix 96 denotes tape and reel. The suffix T denotes a small-quantity reel of 250.

CD54HC02, CD74HC02, CD54HCT02, CD74HCT02

Pinout

CD54HC02, CD54HCT02
(CERDIP)
CD74HC02, CD74HCT02
(PDIP, SOIC)
TOP VIEW

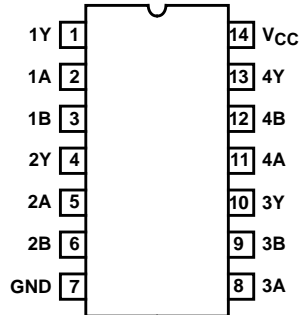

Functional Diagram

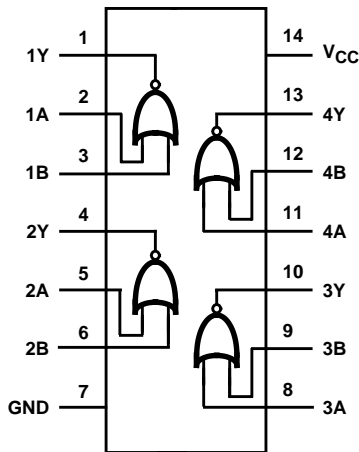

TRUTH TABLE

| INPUTS | | OUTPUT |
|--------|----|--------|
| nA | nB | nY |
| L | L | H |
| L | H | L |
| H | L | L |
| H | H | L |

H = High Voltage Level, L = Low Voltage Level

Logic Diagram

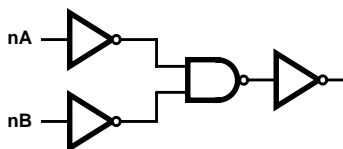

CD54HC02, CD74HC02, CD54HCT02, CD74HCT02

Absolute Maximum Ratings

| | |
|--|-------------|
| DC Supply Voltage, V_{CC} | -0.5V to 7V |
| DC Input Diode Current, I_{IK} | |
| For $V_I < -0.5V$ or $V_I > V_{CC} + 0.5V$ | $\pm 20mA$ |
| DC Output Diode Current, I_{OK} | |
| For $V_O < -0.5V$ or $V_O > V_{CC} + 0.5V$ | $\pm 20mA$ |
| DC Output Source or Sink Current per Output Pin, I_O | |
| For $V_O > -0.5V$ or $V_O < V_{CC} + 0.5V$ | $\pm 25mA$ |
| DC V_{CC} or Ground Current, I_{CC} or I_{GND} | $\pm 50mA$ |

Thermal Information

| | |
|--|----------------------------------|
| Thermal Resistance (Typical, Note 1) | θ_{JA} ($^{\circ}C/W$) |
| E (PDIP) Package | 80 |
| M (SOIC) Package | 86 |
| Maximum Junction Temperature (Hermetic Package or Die) . . . | $175^{\circ}C$ |
| Maximum Junction Temperature (Plastic Package) | $150^{\circ}C$ |
| Maximum Storage Temperature Range | $-65^{\circ}C$ to $150^{\circ}C$ |
| Maximum Lead Temperature (Soldering 10s) | $300^{\circ}C$ |
| (SOIC - Lead Tips Only) | |

Operating Conditions

| | |
|---|----------------------------------|
| Temperature Range (T_A) | $-55^{\circ}C$ to $125^{\circ}C$ |
| Supply Voltage Range, V_{CC} | |
| HC Types | .2V to 6V |
| HCT Types | .4.5V to 5.5V |
| DC Input or Output Voltage, V_I , V_O | 0V to V_{CC} |
| Input Rise and Fall Time | |
| 2V | 1000ns (Max) |
| 4.5V | 500ns (Max) |
| 6V | 400ns (Max) |

CAUTION: Stresses above those listed in "Absolute Maximum Ratings" may cause permanent damage to the device. This is a stress only rating and operation of the device at these or any other conditions above those indicated in the operational sections of this specification is not implied.

NOTE:

1. The package thermal impedance is calculated in accordance with JESD 51-7.

DC Electrical Specifications

| PARAMETER | SYMBOL | TEST CONDITIONS | | V_{CC} (V) | 25°C | | | -40°C TO 85°C | | -55°C TO 125°C | | UNITS |
|---|----------|----------------------|------------|--------------|------|-----|-----------|---------------|---------|----------------|---------|---------|
| | | V_I (V) | I_O (mA) | | MIN | TYP | MAX | MIN | MAX | MIN | MAX | |
| HC TYPES | | | | | | | | | | | | |
| High Level Input Voltage | V_{IH} | - | - | 2 | 1.5 | - | - | 1.5 | - | 1.5 | - | V |
| | | | | 4.5 | 3.15 | - | - | 3.15 | - | 3.15 | - | V |
| | | | | 6 | 4.2 | - | - | 4.2 | - | 4.2 | - | V |
| Low Level Input Voltage | V_{IL} | - | - | 2 | - | - | 0.5 | - | 0.5 | - | 0.5 | V |
| | | | | 4.5 | - | - | 1.35 | - | 1.35 | - | 1.35 | V |
| | | | | 6 | - | - | 1.8 | - | 1.8 | - | 1.8 | V |
| High Level Output Voltage CMOS Loads | V_{OH} | V_{IH} or V_{IL} | -0.02 | 2 | 1.9 | - | - | 1.9 | - | 1.9 | - | V |
| | | | -0.02 | 4.5 | 4.4 | - | - | 4.4 | - | 4.4 | - | V |
| | | | -0.02 | 6 | 5.9 | - | - | 5.9 | - | 5.9 | - | V |
| High Level Output Voltage TTL Loads | V_{OH} | V_{IH} or V_{IL} | - | - | - | - | - | - | - | - | - | V |
| | | | -4 | 4.5 | 3.98 | - | - | 3.84 | - | 3.7 | - | V |
| | | | -5.2 | 6 | 5.48 | - | - | 5.34 | - | 5.2 | - | V |
| Low Level Output Voltage CMOS Loads | V_{OL} | V_{IH} or V_{IL} | 0.02 | 2 | - | - | 0.1 | - | 0.1 | - | 0.1 | V |
| | | | 0.02 | 4.5 | - | - | 0.1 | - | 0.1 | - | 0.1 | V |
| | | | 0.02 | 6 | - | - | 0.1 | - | 0.1 | - | 0.1 | V |
| Low Level Output Voltage TTL Loads | V_{OL} | V_{IH} or V_{IL} | - | - | - | - | - | - | - | - | - | V |
| | | | 4 | 4.5 | - | - | 0.26 | - | 0.33 | - | 0.4 | V |
| | | | 5.2 | 6 | - | - | 0.26 | - | 0.33 | - | 0.4 | V |
| Input Leakage Current | I_I | V_{CC} or GND | - | 6 | - | - | ± 0.1 | - | ± 1 | - | ± 1 | μA |
| Quiescent Device Current | I_{CC} | V_{CC} or GND | 0 | 6 | - | - | 2 | - | 20 | - | 40 | μA |

CD54HC02, CD74HC02, CD54HCT02, CD74HCT02

DC Electrical Specifications (Continued)

| PARAMETER | SYMBOL | TEST CONDITIONS | | V _{CC} (V) | 25°C | | | -40°C TO 85°C | | -55°C TO 125°C | | UNITS |
|--|---------------------------|------------------------------------|---------------------|---------------------|------|-----|------|---------------|------|----------------|-----|-------|
| | | V _I (V) | I _O (mA) | | MIN | TYP | MAX | MIN | MAX | MIN | MAX | |
| HCT TYPES | | | | | | | | | | | | |
| High Level Input Voltage | V _{IH} | - | - | 4.5 to 5.5 | 2 | - | - | 2 | - | 2 | - | V |
| Low Level Input Voltage | V _{IL} | - | - | 4.5 to 5.5 | - | - | 0.8 | - | 0.8 | - | 0.8 | V |
| High Level Output Voltage CMOS Loads | V _{OH} | V _{IH} or V _{IL} | -0.02 | 4.5 | 4.4 | - | - | 4.4 | - | 4.4 | - | V |
| High Level Output Voltage TTL Loads | | | -4 | 4.5 | 3.98 | - | - | 3.84 | - | 3.7 | - | V |
| Low Level Output Voltage CMOS Loads | V _{OL} | V _{IH} or V _{IL} | 0.02 | 4.5 | - | - | 0.1 | - | 0.1 | - | 0.1 | V |
| Low Level Output Voltage TTL Loads | | | 4 | 4.5 | - | - | 0.26 | - | 0.33 | - | 0.4 | V |
| Input Leakage Current | I _I | V _{CC} and GND | 0 | 5.5 | - | - | ±0.1 | - | ±1 | - | ±1 | μA |
| Quiescent Device Current | I _{CC} | V _{CC} or GND | 0 | 5.5 | - | - | 2 | - | 20 | - | 40 | μA |
| Additional Quiescent Device Current Per Input Pin: 1 Unit Load | ΔI _{CC} (Note 2) | V _{CC} -2.1 | - | 4.5 to 5.5 | - | 100 | 360 | - | 450 | - | 490 | μA |

NOTE:

- For dual-supply systems theoretical worst case (V_I = 2.4V, V_{CC} = 5.5V) specification is 1.8mA.

HCT Input Loading Table

| INPUT | UNIT LOADS |
|-------|------------|
| All | 1.5 |

NOTE: Unit Load is ΔI_{CC} limit specified in DC Electrical Table, e.g., 360μA max at 25°C.

Switching Specifications Input t_p, t_f = 6ns

| PARAMETER | SYMBOL | TEST CONDITIONS | V _{CC} (V) | 25°C | | | -40°C TO 85°C | | -55°C TO 125°C | | UNITS |
|---|-------------------------------------|-----------------------|---------------------|------|-----|-----|---------------|-----|----------------|-----|-------|
| | | | | MIN | TYP | MAX | MIN | MAX | MIN | MAX | |
| HC TYPES | | | | | | | | | | | |
| Propagation Delay, Input to Output (Figure 1) | t _{PLH} , t _{PHL} | C _L = 50pF | 2 | - | - | 90 | - | 115 | - | 135 | ns |
| | | | 4.5 | - | - | 18 | - | 23 | - | 27 | ns |
| | | | 6 | - | - | 15 | - | 20 | - | 23 | ns |
| Propagation Delay, Data Input to Output Y | t _{PLH} , t _{PHL} | C _L = 15pF | 5 | - | 7 | - | - | - | - | - | ns |
| Transition Times (Figure 1) | t _{TLH} , t _{THL} | C _L = 50pF | 2 | - | - | 75 | - | 95 | - | 110 | ns |
| | | | 4.5 | - | - | 15 | - | 19 | - | 22 | ns |
| | | | 6 | - | - | 13 | - | 16 | - | 19 | ns |
| Input Capacitance | C _{IN} | - | - | - | - | 10 | - | 10 | - | 10 | pF |

CD54HC02, CD74HC02, CD54HCT, CD74HCT02

Switching Specifications Input $t_r, t_f = 6\text{ns}$ (Continued)

| PARAMETER | SYMBOL | TEST CONDITIONS | V_{CC} (V) | 25°C | | | -40°C TO 85°C | | -55°C TO 125°C | | UNITS |
|---|--------------------|---------------------|--------------|------|-----|-----|---------------|-----|----------------|-----|-------|
| | | | | MIN | TYP | MAX | MIN | MAX | MIN | MAX | |
| Power Dissipation Capacitance (Notes 3, 4) | C_{PD} | - | 5 | - | 26 | - | - | - | - | - | pF |
| HCT TYPES | | | | | | | | | | | |
| Propagation Delay, Input to Output (Figure 2) | t_{PLH}, t_{PHL} | $C_L = 50\text{pF}$ | 4.5 | - | - | 21 | - | 26 | - | 32 | ns |
| Propagation Delay, Data Input to Output Y | t_{PLH}, t_{PHL} | $C_L = 15\text{pF}$ | 5 | - | 8 | - | - | - | - | - | ns |
| Transition Times (Figure 2) | t_{TLH}, t_{THL} | $C_L = 50\text{pF}$ | 4.5 | - | - | 15 | - | 19 | - | 22 | ns |
| Input Capacitance | C_{IN} | - | - | - | - | 10 | - | 10 | - | 10 | pF |
| Power Dissipation Capacitance (Notes 3, 4) | C_{PD} | - | 5 | - | 26 | - | - | - | - | - | pF |

NOTES:

3. C_{PD} is used to determine the dynamic power consumption, per gate.
4. $P_D = V_{CC}^2 f_i (C_{PD} + C_L)$ where f_i = input frequency, C_L = output load capacitance, V_{CC} = supply voltage.

Test Circuits and Waveforms

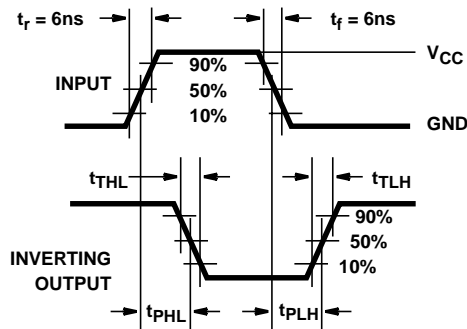

FIGURE 1. HC AND HCU TRANSITION TIMES AND PROPAGATION DELAY TIMES, COMBINATION LOGIC

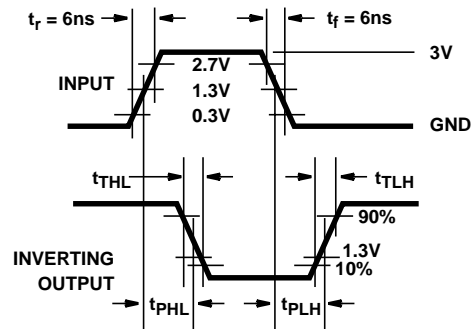

FIGURE 2. HCT TRANSITION TIMES AND PROPAGATION DELAY TIMES, COMBINATION LOGIC

PACKAGING INFORMATION

| Orderable Device | Status (1) | Package Type | Package Drawing | Pins | Package Qty | Eco Plan (2) | Lead/Ball Finish (6) | MSL Peak Temp (3) | Op Temp (°C) | Device Marking (4/5) | Samples |
|------------------|---------------|--------------|--------------------|------|----------------|----------------------------|-------------------------|----------------------|--------------|--------------------------------|-------------------------|
| 5962-8975101CA | ACTIVE | CDIP | J | 14 | 1 | TBD | A42 | N / A for Pkg Type | -55 to 125 | 5962-8975101CA CD54HCT02F3A | Samples |
| CD54HC02F | ACTIVE | CDIP | J | 14 | 1 | TBD | A42 | N / A for Pkg Type | -55 to 125 | CD54HC02F | Samples |
| CD54HC02F3A | ACTIVE | CDIP | J | 14 | 1 | TBD | A42 | N / A for Pkg Type | -55 to 125 | 8404101CA CD54HC02F3A | Samples |
| CD54HCT02F | ACTIVE | CDIP | J | 14 | 1 | TBD | A42 | N / A for Pkg Type | -55 to 125 | CD54HCT02F | Samples |
| CD54HCT02F3A | ACTIVE | CDIP | J | 14 | 1 | TBD | A42 | N / A for Pkg Type | -55 to 125 | 5962-8975101CA CD54HCT02F3A | Samples |
| CD74HC02E | ACTIVE | PDIP | N | 14 | 25 | Green (RoHS & no Sb/Br) | CU NIPDAU | N / A for Pkg Type | -55 to 125 | CD74HC02E | Samples |
| CD74HC02EE4 | ACTIVE | PDIP | N | 14 | 25 | Green (RoHS & no Sb/Br) | CU NIPDAU | N / A for Pkg Type | -55 to 125 | CD74HC02E | Samples |
| CD74HC02M | ACTIVE | SOIC | D | 14 | 50 | Green (RoHS & no Sb/Br) | CU NIPDAU | Level-1-260C-UNLIM | -55 to 125 | HC02M | Samples |
| CD74HC02M96 | ACTIVE | SOIC | D | 14 | 2500 | Green (RoHS & no Sb/Br) | CU NIPDAU | Level-1-260C-UNLIM | -55 to 125 | HC02M | Samples |
| CD74HC02M96G4 | ACTIVE | SOIC | D | 14 | 2500 | Green (RoHS & no Sb/Br) | CU NIPDAU | Level-1-260C-UNLIM | -55 to 125 | HC02M | Samples |
| CD74HC02ME4 | ACTIVE | SOIC | D | 14 | 50 | Green (RoHS & no Sb/Br) | CU NIPDAU | Level-1-260C-UNLIM | -55 to 125 | HC02M | Samples |
| CD74HC02MG4 | ACTIVE | SOIC | D | 14 | 50 | Green (RoHS & no Sb/Br) | CU NIPDAU | Level-1-260C-UNLIM | -55 to 125 | HC02M | Samples |
| CD74HC02MT | ACTIVE | SOIC | D | 14 | 250 | Green (RoHS & no Sb/Br) | CU NIPDAU | Level-1-260C-UNLIM | -55 to 125 | HC02M | Samples |
| CD74HC02MTG4 | ACTIVE | SOIC | D | 14 | 250 | Green (RoHS & no Sb/Br) | CU NIPDAU | Level-1-260C-UNLIM | -55 to 125 | HC02M | Samples |
| CD74HCT02E | ACTIVE | PDIP | N | 14 | 25 | Green (RoHS & no Sb/Br) | CU NIPDAU | N / A for Pkg Type | -55 to 125 | CD74HCT02E | Samples |
| CD74HCT02EE4 | ACTIVE | PDIP | N | 14 | 25 | Green (RoHS & no Sb/Br) | CU NIPDAU | N / A for Pkg Type | -55 to 125 | CD74HCT02E | Samples |
| CD74HCT02M | ACTIVE | SOIC | D | 14 | 50 | Green (RoHS & no Sb/Br) | CU NIPDAU | Level-1-260C-UNLIM | -55 to 125 | HCT02M | Samples |

| Orderable Device | Status (1) | Package Type | Package Drawing | Pins | Package Qty | Eco Plan (2) | Lead/Ball Finish (6) | MSL Peak Temp (3) | Op Temp (°C) | Device Marking (4/5) | Samples |
|------------------|---------------|--------------|-----------------|------|-------------|-------------------------|-------------------------|----------------------|--------------|-------------------------|-------------------------|
| CD74HCT02M96 | ACTIVE | SOIC | D | 14 | 2500 | Green (RoHS & no Sb/Br) | CU NIPDAU | Level-1-260C-UNLIM | -55 to 125 | HCT02M | Samples |
| CD74HCT02M96E4 | ACTIVE | SOIC | D | 14 | 2500 | Green (RoHS & no Sb/Br) | CU NIPDAU | Level-1-260C-UNLIM | -55 to 125 | HCT02M | Samples |
| CD74HCT02MT | ACTIVE | SOIC | D | 14 | 250 | Green (RoHS & no Sb/Br) | CU NIPDAU | Level-1-260C-UNLIM | -55 to 125 | HCT02M | Samples |

(1) The marketing status values are defined as follows:

ACTIVE: Product device recommended for new designs.

LIFEBUY: TI has announced that the device will be discontinued, and a lifetime-buy period is in effect.

NRND: Not recommended for new designs. Device is in production to support existing customers, but TI does not recommend using this part in a new design.

PREVIEW: Device has been announced but is not in production. Samples may or may not be available.

OBSOLETE: TI has discontinued the production of the device.

(2) **RoHS:** TI defines "RoHS" to mean semiconductor products that are compliant with the current EU RoHS requirements for all 10 RoHS substances, including the requirement that RoHS substance do not exceed 0.1% by weight in homogeneous materials. Where designed to be soldered at high temperatures, "RoHS" products are suitable for use in specified lead-free processes. TI may reference these types of products as "Pb-Free".

RoHS Exempt: TI defines "RoHS Exempt" to mean products that contain lead but are compliant with EU RoHS pursuant to a specific EU RoHS exemption.

Green: TI defines "Green" to mean the content of Chlorine (Cl) and Bromine (Br) based flame retardants meet JS709B low halogen requirements of <=1000ppm threshold. Antimony trioxide based flame retardants must also meet the <=1000ppm threshold requirement.

(3) MSL, Peak Temp. - The Moisture Sensitivity Level rating according to the JEDEC industry standard classifications, and peak solder temperature.

(4) There may be additional marking, which relates to the logo, the lot trace code information, or the environmental category on the device.

(5) Multiple Device Markings will be inside parentheses. Only one Device Marking contained in parentheses and separated by a "~" will appear on a device. If a line is indented then it is a continuation of the previous line and the two combined represent the entire Device Marking for that device.

(6) Lead/Ball Finish - Orderable Devices may have multiple material finish options. Finish options are separated by a vertical ruled line. Lead/Ball Finish values may wrap to two lines if the finish value exceeds the maximum column width.

Important Information and Disclaimer:The information provided on this page represents TI's knowledge and belief as of the date that it is provided. TI bases its knowledge and belief on information provided by third parties, and makes no representation or warranty as to the accuracy of such information. Efforts are underway to better integrate information from third parties. TI has taken and continues to take reasonable steps to provide representative and accurate information but may not have conducted destructive testing or chemical analysis on incoming materials and chemicals. TI and TI suppliers consider certain information to be proprietary, and thus CAS numbers and other limited information may not be available for release.

In no event shall TI's liability arising out of such information exceed the total purchase price of the TI part(s) at issue in this document sold by TI to Customer on an annual basis.

OTHER QUALIFIED VERSIONS OF CD54HC02, CD54HCT02, CD74HC02, CD74HCT02 :

- Catalog: [CD74HC02](#), [CD74HCT02](#)
- Military: [CD54HC02](#), [CD54HCT02](#)

NOTE: Qualified Version Definitions:

- Catalog - TI's standard catalog product
- Military - QML certified for Military and Defense Applications

TAPE AND REEL INFORMATION

QUADRANT ASSIGNMENTS FOR PIN 1 ORIENTATION IN TAPE

*All dimensions are nominal

| Device | Package Type | Package Drawing | Pins | SPQ | Reel Diameter (mm) | Reel Width W1 (mm) | A0 (mm) | B0 (mm) | K0 (mm) | P1 (mm) | W (mm) | Pin1 Quadrant |
|--------------|--------------|-----------------|------|------|--------------------|--------------------|---------|---------|---------|---------|--------|---------------|
| CD74HC02M96 | SOIC | D | 14 | 2500 | 330.0 | 16.4 | 6.5 | 9.0 | 2.1 | 8.0 | 16.0 | Q1 |
| CD74HC02MT | SOIC | D | 14 | 250 | 330.0 | 16.4 | 6.5 | 9.0 | 2.1 | 8.0 | 16.0 | Q1 |
| CD74HCT02M96 | SOIC | D | 14 | 2500 | 330.0 | 16.4 | 6.5 | 9.0 | 2.1 | 8.0 | 16.0 | Q1 |
| CD74HCT02MT | SOIC | D | 14 | 250 | 330.0 | 16.4 | 6.5 | 9.0 | 2.1 | 8.0 | 16.0 | Q1 |

TAPE AND REEL BOX DIMENSIONS

*All dimensions are nominal

| Device | Package Type | Package Drawing | Pins | SPQ | Length (mm) | Width (mm) | Height (mm) |
|--------------|--------------|-----------------|------|------|-------------|------------|-------------|
| CD74HC02M96 | SOIC | D | 14 | 2500 | 367.0 | 367.0 | 38.0 |
| CD74HC02MT | SOIC | D | 14 | 250 | 210.0 | 185.0 | 35.0 |
| CD74HCT02M96 | SOIC | D | 14 | 2500 | 367.0 | 367.0 | 38.0 |
| CD74HCT02MT | SOIC | D | 14 | 250 | 210.0 | 185.0 | 35.0 |

J 14

GENERIC PACKAGE VIEW
CDIP - 5.08 mm max height
CERAMIC DUAL IN LINE PACKAGE



Images above are just a representation of the package family, actual package may vary.
Refer to the product data sheet for package details.

4040083-5/G

J0014A



PACKAGE OUTLINE

CDIP - 5.08 mm max height

CERAMIC DUAL IN LINE PACKAGE



4214771/A 05/2017

NOTES:

1. All controlling linear dimensions are in inches. Dimensions in brackets are in millimeters. Any dimension in brackets or parenthesis are for reference only. Dimensioning and tolerancing per ASME Y14.5M.
2. This drawing is subject to change without notice.
3. This package is hermetically sealed with a ceramic lid using glass frit.
4. Index point is provided on cap for terminal identification only and on press ceramic glass frit seal only.
5. Falls within MIL-STD-1835 and GDIP1-T14.

EXAMPLE BOARD LAYOUT

J0014A

CDIP - 5.08 mm max height

CERAMIC DUAL IN LINE PACKAGE



LAND PATTERN EXAMPLE
NON-SOLDER MASK DEFINED
SCALE: 5X





4214771/A 05/2017

D (R-PDSO-G14)

PLASTIC SMALL OUTLINE



- NOTES:
- A. All linear dimensions are in inches (millimeters).
 - B. This drawing is subject to change without notice.
 -  Body length does not include mold flash, protrusions, or gate burrs. Mold flash, protrusions, or gate burrs shall not exceed 0.006 (0,15) each side.
 -  Body width does not include interlead flash. Interlead flash shall not exceed 0.017 (0,43) each side.
 - E. Reference JEDEC MS-012 variation AB.

D (R-PDSO-G14)

PLASTIC SMALL OUTLINE



4211283-3/E 08/12

- NOTES:
- All linear dimensions are in millimeters.
 - This drawing is subject to change without notice.
 - Publication IPC-7351 is recommended for alternate designs.
 - Laser cutting apertures with trapezoidal walls and also rounding corners will offer better paste release. Customers should contact their board assembly site for stencil design recommendations. Refer to IPC-7525 for other stencil recommendations.
 - Customers should contact their board fabrication site for solder mask tolerances between and around signal pads.

N (R-PDIP-T**)

PLASTIC DUAL-IN-LINE PACKAGE

16 PINS SHOWN



4040049/E 12/2002

- NOTES:
- A. All linear dimensions are in inches (millimeters).
 - B. This drawing is subject to change without notice.
 - (C) Falls within JEDEC MS-001, except 18 and 20 pin minimum body length (Dim A).
 - (D) The 20 pin end lead shoulder width is a vendor option, either half or full width.

IMPORTANT NOTICE AND DISCLAIMER

TI PROVIDES TECHNICAL AND RELIABILITY DATA (INCLUDING DATASHEETS), DESIGN RESOURCES (INCLUDING REFERENCE DESIGNS), APPLICATION OR OTHER DESIGN ADVICE, WEB TOOLS, SAFETY INFORMATION, AND OTHER RESOURCES "AS IS" AND WITH ALL FAULTS, AND DISCLAIMS ALL WARRANTIES, EXPRESS AND IMPLIED, INCLUDING WITHOUT LIMITATION ANY IMPLIED WARRANTIES OF MERCHANTABILITY, FITNESS FOR A PARTICULAR PURPOSE OR NON-INFRINGEMENT OF THIRD PARTY INTELLECTUAL PROPERTY RIGHTS.

These resources are intended for skilled developers designing with TI products. You are solely responsible for (1) selecting the appropriate TI products for your application, (2) designing, validating and testing your application, and (3) ensuring your application meets applicable standards, and any other safety, security, or other requirements. These resources are subject to change without notice. TI grants you permission to use these resources only for development of an application that uses the TI products described in the resource. Other reproduction and display of these resources is prohibited. No license is granted to any other TI intellectual property right or to any third party intellectual property right. TI disclaims responsibility for, and you will fully indemnify TI and its representatives against, any claims, damages, costs, losses, and liabilities arising out of your use of these resources.

TI's products are provided subject to TI's Terms of Sale (www.ti.com/legal/termsofsale.html) or other applicable terms available either on ti.com or provided in conjunction with such TI products. TI's provision of these resources does not expand or otherwise alter TI's applicable warranties or warranty disclaimers for TI products.

Mailing Address: Texas Instruments, Post Office Box 655303, Dallas, Texas 75265
Copyright © 2018, Texas Instruments Incorporated

Looking for pricing, stock, or lifecycle information?

Click below to explore more details on WIN SOURCE:

 [View CD74HCT02M96](#) on WIN SOURCE

 [Texas Instruments](#) Information

Optimize Your Supply Chain with WIN SOURCE Solutions

-  Global Sourcing Solution
-  Obsolete Management
-  Cost Control Management
-  Shortage Management
-  Alternative Solution
-  Excess Inventory Management