



**THE DATASHEET OF
CAT28C64BLI12**





64K-Bit CMOS PARALLEL EEPROM



FEATURES

- **Fast read access times:**
 - 90/120/150ns
- **Low power CMOS dissipation:**
 - Active: 25 mA max.
 - Standby: 100 μ A max.
- **Simple write operation:**
 - On-chip address and data latches
 - Self-timed write cycle with auto-clear
- **Fast write cycle time:**
 - 5ms max.
- **CMOS and TTL compatible I/O**
- **Hardware and software write protection**
- **Commercial, industrial and automotive temperature ranges**
- **Automatic page write operation:**
 - 1 to 32 bytes in 5ms
 - Page load timer
- **End of write detection:**
 - Toggle bit
 - $\overline{\text{DATA}}$ polling
- **100,000 program/erase cycles**
- **100 year data retention**

DESCRIPTION

The CAT28C64B is a fast, low power, 5V-only CMOS Parallel EEPROM organized as 8K x 8-bits. It requires a simple interface for in-system programming. On-chip address and data latches, self-timed write cycle with auto-clear and V_{CC} power up/down write protection eliminate additional timing and protection hardware. $\overline{\text{DATA}}$ Polling and Toggle status bits signal the start and end of the self-timed write cycle. Additionally, the CAT28C64B features hardware and software write protection.

The CAT28C64B is manufactured using Catalyst's advanced CMOS floating gate technology. It is designed to endure 100,000 program/erase cycles and has a data retention of 100 years. The device is available in JEDEC-approved 28-pin DIP, TSOP, SOIC, or, 32-pin PLCC package .

BLOCK DIAGRAM

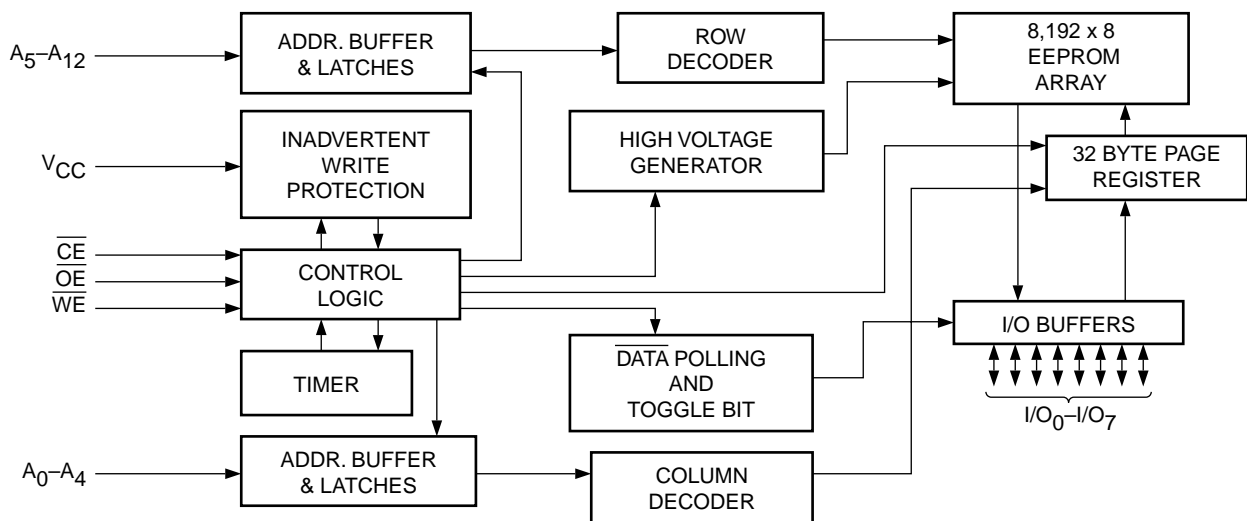

PIN CONFIGURATION

DIP Package (P, L)

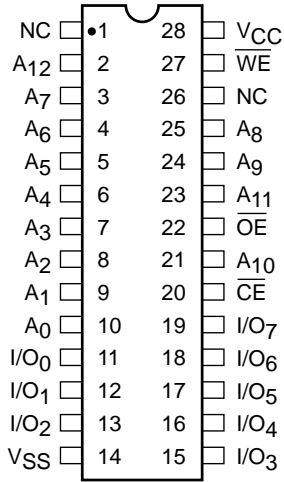

SOIC Package (J, W) (K, X)

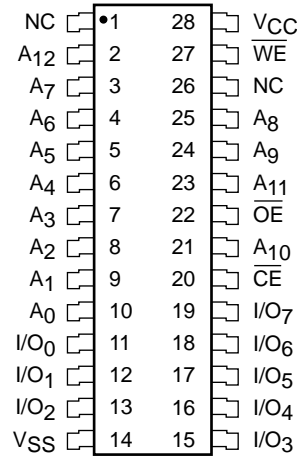

PLCC Package (N, G)

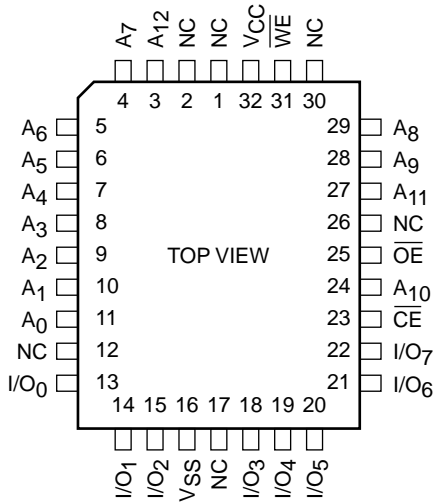

TSOP Package (8mm x 13.4mm) (H13)

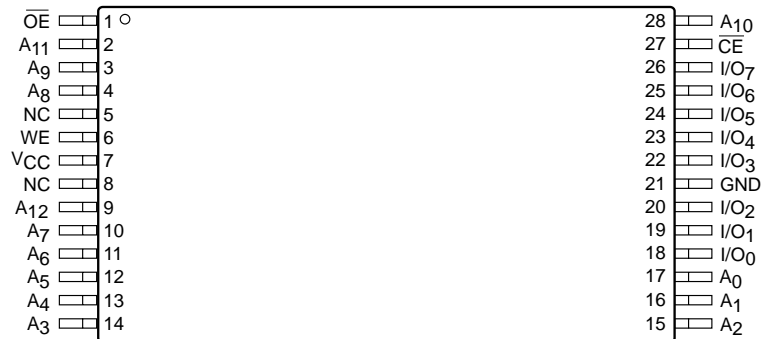

PIN FUNCTIONS

Pin Name	Function	Pin Name	Function
A ₀ –A ₁₂	Address Inputs	\overline{WE}	Write Enable
I/O ₀ –I/O ₇	Data Inputs/Outputs	V _{CC}	5 V Supply
\overline{CE}	Chip Enable	V _{SS}	Ground
\overline{OE}	Output Enable	NC	No Connect

ABSOLUTE MAXIMUM RATINGS*

Temperature Under Bias -55°C to +125°C
 Storage Temperature -65°C to +150°C
 Voltage on Any Pin with
 Respect to Ground⁽²⁾ -2.0V to +V_{CC} + 2.0V
 V_{CC} with Respect to Ground -2.0V to +7.0V
 Package Power Dissipation
 Capability (T_a = 25°C) 1.0W
 Lead Soldering Temperature (10 secs) 300°C
 Output Short Circuit Current⁽³⁾ 100 mA



***COMMENT**

Stresses above those listed under “Absolute Maximum Ratings” may cause permanent damage to the device. These are stress ratings only, and functional operation of the device at these or any other conditions outside of those listed in the operational sections of this specification is not implied. Exposure to any absolute maximum rating for extended periods may affect device performance and reliability.

RELIABILITY CHARACTERISTICS

Symbol	Parameter	Min.	Max.	Units	Test Method
N _{END} ⁽¹⁾	Endurance	10 ⁵		Cycles/Byte	MIL-STD-883, Test Method 1033
T _{DR} ⁽¹⁾	Data Retention	100		Years	MIL-STD-883, Test Method 1008
V _{ZAP} ⁽¹⁾	ESD Susceptibility	2000		Volts	MIL-STD-883, Test Method 3015
I _{LTH} ⁽¹⁾⁽⁴⁾	Latch-Up	100		mA	JEDEC Standard 17

MODE SELECTION

Mode	\overline{CE}	\overline{WE}	\overline{OE}	I/O	Power
Read	L	H	L	D _{OUT}	ACTIVE
Byte Write (\overline{WE} Controlled)	L		H	D _{IN}	ACTIVE
Byte Write (\overline{CE} Controlled)		L	H	D _{IN}	ACTIVE
Standby, and Write Inhibit	H	X	X	High-Z	STANDBY
Read and Write Inhibit	X	H	H	High-Z	ACTIVE

CAPACITANCE T_A = 25°C, f = 1.0 MHz, V_{CC} = 5V

Symbol	Test	Max.	Units	Conditions
C _{I/O} ⁽¹⁾	Input/Output Capacitance	10	pF	V _{I/O} = 0V
C _{IN} ⁽¹⁾	Input Capacitance	6	pF	V _{IN} = 0V

Note:

- (1) This parameter is tested initially and after a design or process change that affects the parameter.
- (2) The minimum DC input voltage is -0.5V. During transitions, inputs may undershoot to -2.0V for periods of less than 20 ns. Maximum DC voltage on output pins is V_{CC} +0.5V, which may overshoot to V_{CC} +2.0V for periods of less than 20 ns.
- (3) Output shorted for no more than one second. No more than one output shorted at a time.
- (4) Latch-up protection is provided for stresses up to 100mA on address and data pins from -1V to V_{CC} +1V.

D.C. OPERATING CHARACTERISTICS

V_{CC} = 5V ±10%, unless otherwise specified.

Symbol	Parameter	Limits			Units	Test Conditions
		Min.	Typ.	Max.		
I _{CC}	V _{CC} Current (Operating, TTL)			30	mA	$\overline{CE} = \overline{OE} = V_{IL}$, f = 1/t _{RC} min, All I/O's Open
I _{CCC} ⁽¹⁾	V _{CC} Current (Operating, CMOS)			25	mA	$\overline{CE} = \overline{OE} = V_{ILC}$, f = 1/t _{RC} min, All I/O's Open
I _{SB}	V _{CC} Current (Standby, TTL)			1	mA	$\overline{CE} = V_{IH}$, All I/O's Open
I _{SBC} ⁽²⁾	V _{CC} Current (Standby, CMOS)			100	μA	$\overline{CE} = V_{IHC}$, All I/O's Open
I _{LI}	Input Leakage Current	-10		10	μA	V _{IN} = GND to V _{CC}
I _{LO}	Output Leakage Current	-10		10	μA	V _{OUT} = GND to V _{CC} , $\overline{CE} = V_{IH}$
V _{IH} ⁽²⁾	High Level Input Voltage	2		V _{CC} +0.3	V	
V _{IL} ⁽¹⁾	Low Level Input Voltage	-0.3		0.8	V	
V _{OH}	High Level Output Voltage	2.4			V	I _{OH} = -400μA
V _{OL}	Low Level Output Voltage			0.4	V	I _{OL} = 2.1mA
V _{WI}	Write Inhibit Voltage	3.5			V	

Note:

(1) V_{ILC} = -0.3V to +0.3V.

(2) V_{IHC} = V_{CC} -0.3V to V_{CC} +0.3V.

A.C. CHARACTERISTICS, Read Cycle

V_{CC} = 5V ±10%, unless otherwise specified.

Symbol	Parameter	28C64B-90		28C64B-12		28C64B-15		Units
		Min.	Max.	Min.	Max.	Min.	Max.	
t _{RC}	Read Cycle Time	90		120		150		ns
t _{CE}	\overline{CE} Access Time		90		120		150	ns
t _{AA}	Address Access Time		90		120		150	ns
t _{OE}	\overline{OE} Access Time		50		60		70	ns
t _{LZ} ⁽¹⁾	\overline{CE} Low to Active Output	0		0		0		ns
t _{OLZ} ⁽¹⁾	\overline{OE} Low to Active Output	0		0		0		ns
t _{HZ} ⁽¹⁾⁽²⁾	\overline{CE} High to High-Z Output		50		50		50	ns
t _{OHZ} ⁽¹⁾⁽²⁾	\overline{OE} High to High-Z Output		50		50		50	ns
t _{OH} ⁽¹⁾	Output Hold from Address Change	0		0		0		ns

Figure 1. A.C. Testing Input/Output Waveform(3)

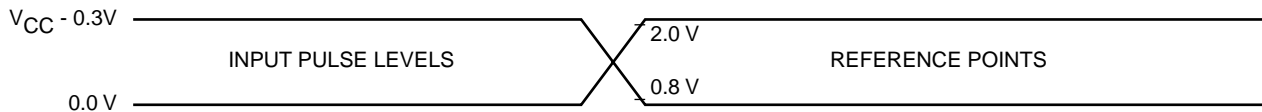
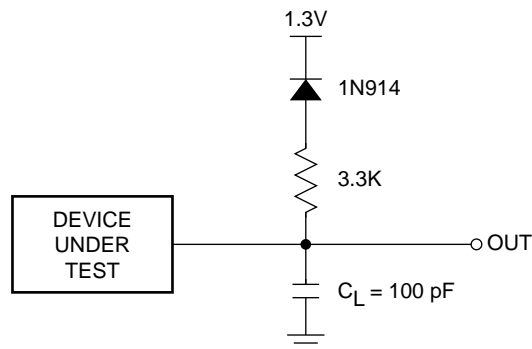

Figure 2. A.C. Testing Load Circuit (example)



C_L INCLUDES JIG CAPACITANCE

Note:

- (1) This parameter is tested initially and after a design or process change that affects the parameter.
- (2) Output floating (High-Z) is defined as the state when the external data line is no longer driven by the output buffer.
- (3) Input rise and fall times (10% and 90%) < 10 ns.

A.C. CHARACTERISTICS, Write Cycle

V_{CC} = 5V ±10%, unless otherwise specified.

Symbol	Parameter	28C64B-90		28C64B-12		28C64B-15		Units
		Min.	Max.	Min.	Max.	Min.	Max.	
t _{WC}	Write Cycle Time		5		5		5	ms
t _{AS}	Address Setup Time	0		0		0		ns
t _{AH}	Address Hold Time	100		100		100		ns
t _{CS}	$\overline{\text{CE}}$ Setup Time	0		0		0		ns
t _{CH}	$\overline{\text{CE}}$ Hold Time	0		0		0		ns
t _{CW} ⁽²⁾	$\overline{\text{CE}}$ Pulse Time	110		110		110		ns
t _{OES}	$\overline{\text{OE}}$ Setup Time	0		0		0		ns
t _{OEH}	$\overline{\text{OE}}$ Hold Time	0		0		0		ns
t _{WP} ⁽²⁾	$\overline{\text{WE}}$ Pulse Width	110		110		110		ns
t _{DS}	Data Setup Time	60		60		60		ns
t _{DH}	Data Hold Time	0		0		0		ns
t _{INIT} ⁽¹⁾	Write Inhibit Period After Power-up	5	10	5	10	5	10	ms
t _{BLC} ⁽¹⁾⁽³⁾	Byte Load Cycle Time	.05	100	.05	100	.05	100	μs

Note:

- (1) This parameter is tested initially and after a design or process change that affects the parameter.
- (2) A write pulse of less than 20ns duration will not initiate a write cycle.
- (3) A timer of duration t_{BLC} max. begins with every LOW to HIGH transition of $\overline{\text{WE}}$. If allowed to time out, a page or byte write will begin; however a transition from HIGH to LOW within t_{BLC} max. stops the timer.

DEVICE OPERATION

Read

Data stored in the CAT28C64B is transferred to the data bus when \overline{WE} is held high, and both \overline{OE} and \overline{CE} are held low. The data bus is set to a high impedance state when either \overline{CE} or \overline{OE} goes high. This 2-line control architecture can be used to eliminate bus contention in a system environment.

Byte Write

A write cycle is executed when both \overline{CE} and \overline{WE} are low, and \overline{OE} is high. Write cycles can be initiated using either \overline{WE} or \overline{CE} , with the address input being latched on the falling edge of \overline{WE} or \overline{CE} , whichever occurs last. Data, conversely, is latched on the rising edge of \overline{WE} or \overline{CE} , whichever occurs first. Once initiated, a byte write cycle automatically erases the addressed byte and the new data is written within 5 ms.

Figure 3. Read Cycle

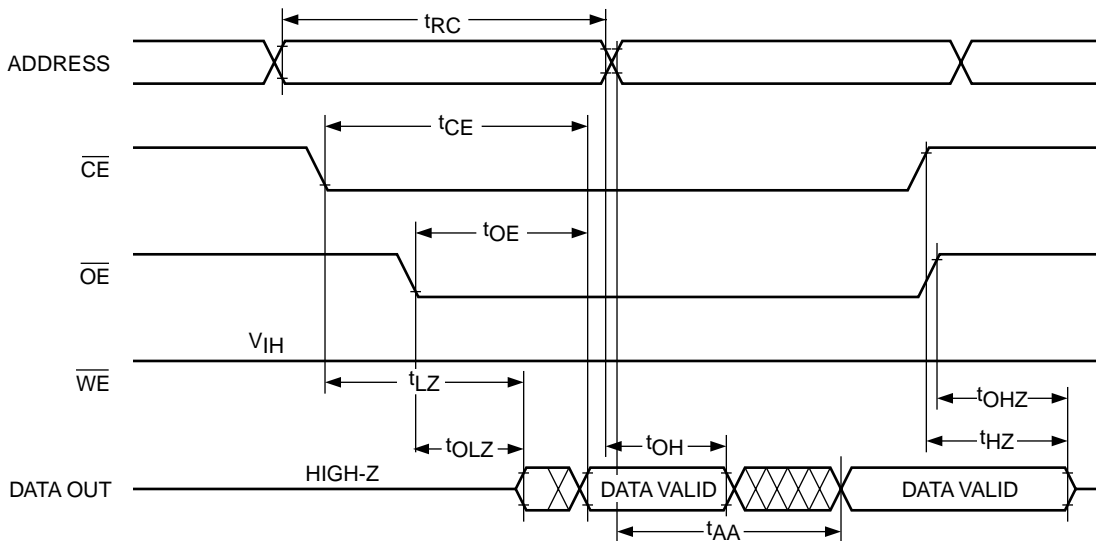
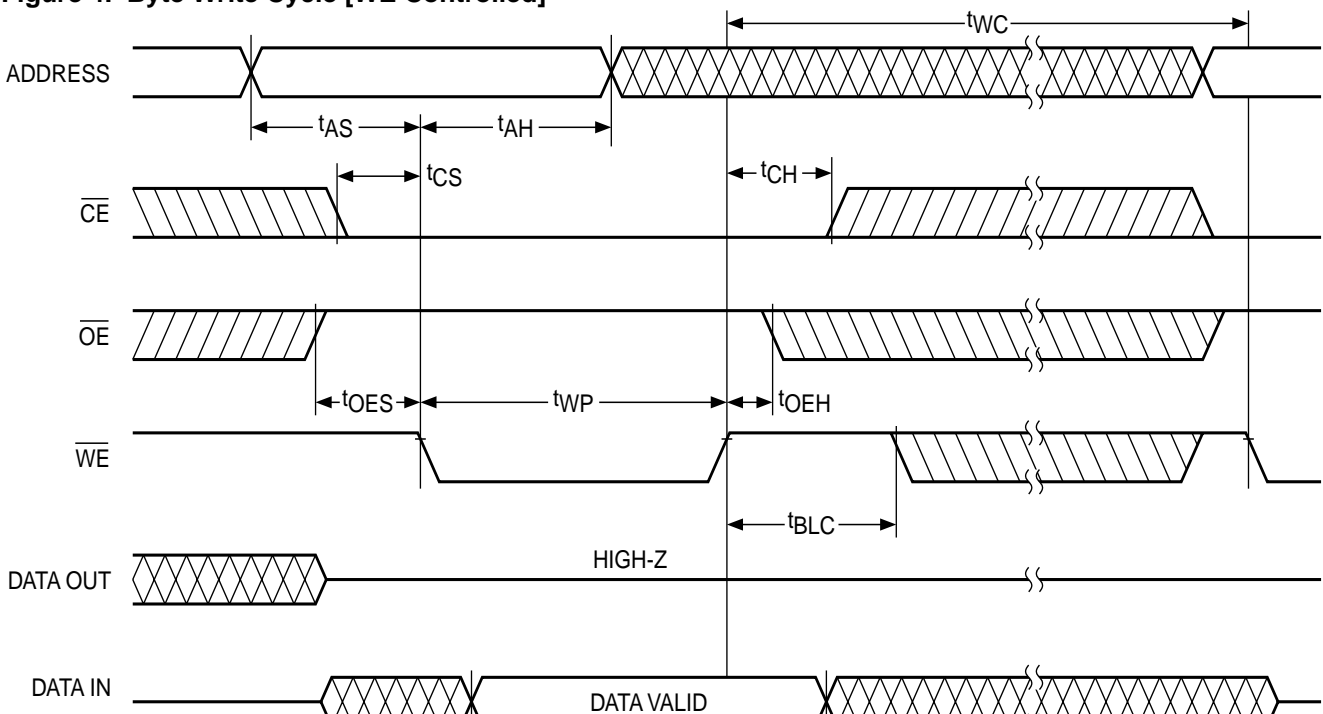

Figure 4. Byte Write Cycle [\overline{WE} Controlled]



Page Write

The page write mode of the CAT28C64B (essentially an extended BYTE WRITE mode) allows from 1 to 32 bytes of data to be programmed within a single EEPROM write cycle. This effectively reduces the byte-write time by a factor of 32.

Following an initial WRITE operation (\overline{WE} pulsed low, for t_{WP} , and then high) the page write mode can begin by issuing sequential \overline{WE} pulses, which load the address and data bytes into a 32 byte temporary buffer. The page address where data is to be written, specified by bits A_5 to A_{12} , is latched on the last falling edge of \overline{WE} . Each byte within the page is defined by address bits A_0 to A_4

(which can be loaded in any order) during the first and subsequent write cycles. Each successive byte load cycle must begin within $t_{BLC\ MAX}$ of the rising edge of the preceding \overline{WE} pulse. There is no page write window limitation as long as \overline{WE} is pulsed low within $t_{BLC\ MAX}$.

Upon completion of the page write sequence, \overline{WE} must stay high a minimum of $t_{BLC\ MAX}$ for the internal automatic program cycle to commence. This programming cycle consists of an erase cycle, which erases any data that existed in each addressed cell, and a write cycle, which writes new data back into the cell. A page write will only write data to the locations that were addressed and will not rewrite the entire page.

Figure 5. Byte Write Cycle [\overline{CE} Controlled]

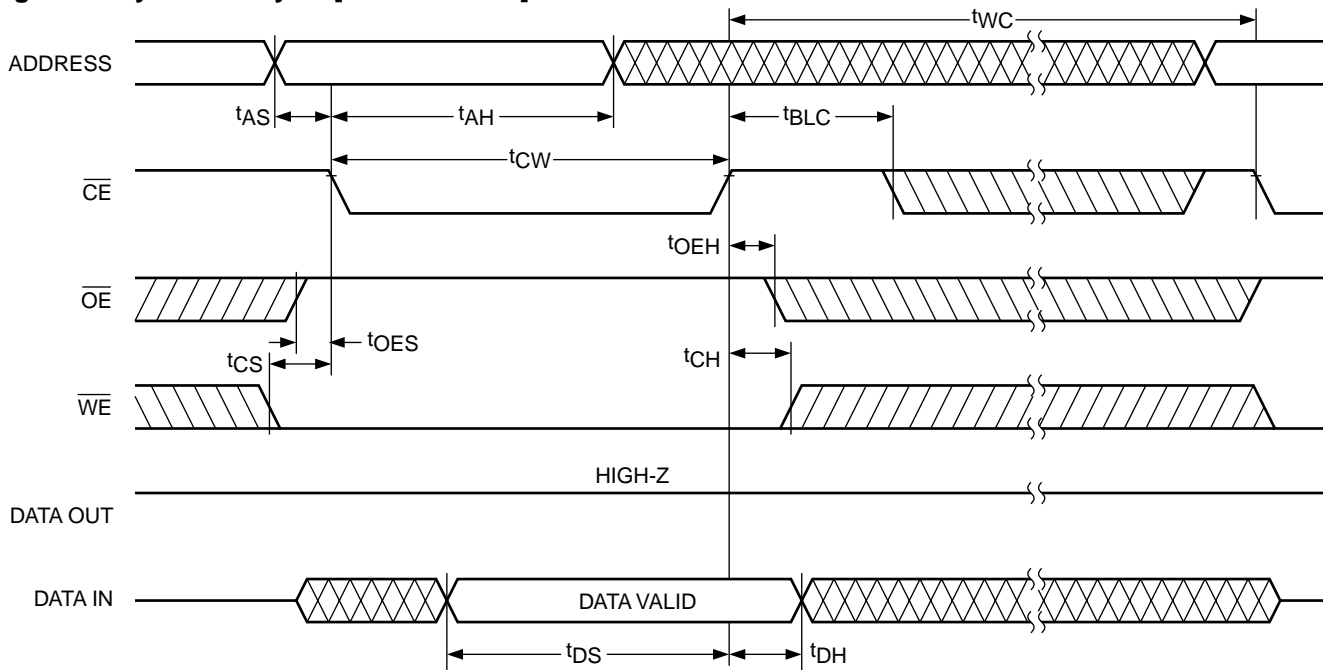
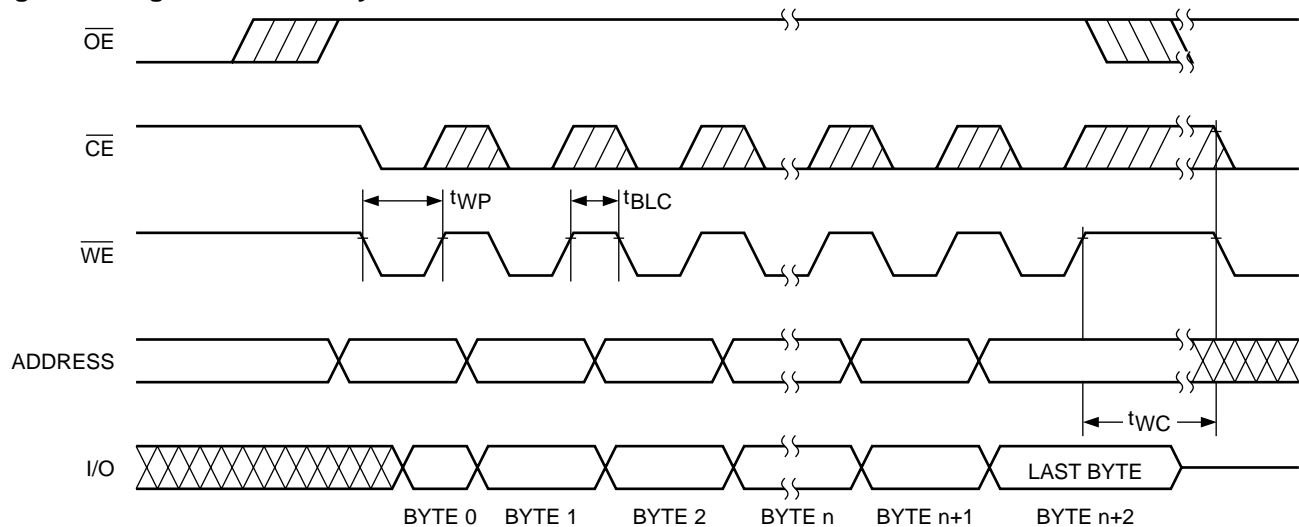

Figure 6. Page Mode Write Cycle



DATA Polling

$\overline{\text{DATA}}$ polling is provided to indicate the completion of write cycle. Once a byte write or page write cycle is initiated, attempting to read the last byte written will output the complement of that data on I/O₇ (I/O₀–I/O₆ are indeterminate) until the programming cycle is complete. Upon completion of the self-timed write cycle, all I/O's will output true data during a read cycle.

Toggle Bit

In addition to the $\overline{\text{DATA}}$ Polling feature, the device offers an additional method for determining the completion of a write cycle. While a write cycle is in progress, reading data from the device will result in I/O₆ toggling between one and zero. However, once the write is complete, I/O₆ stops toggling and valid data can be read from the device.

Figure 7. $\overline{\text{DATA}}$ Polling

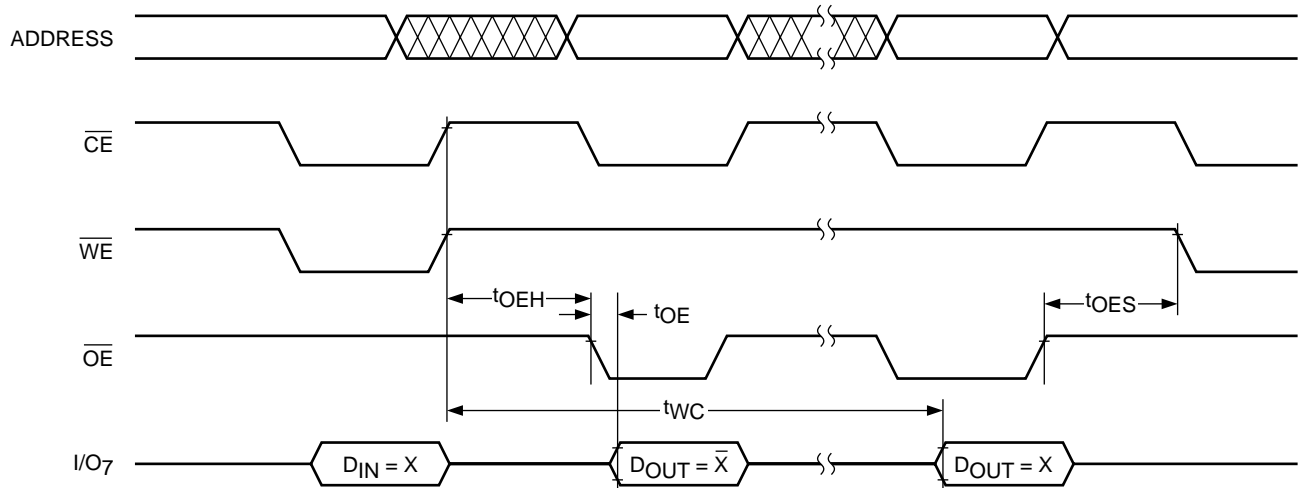
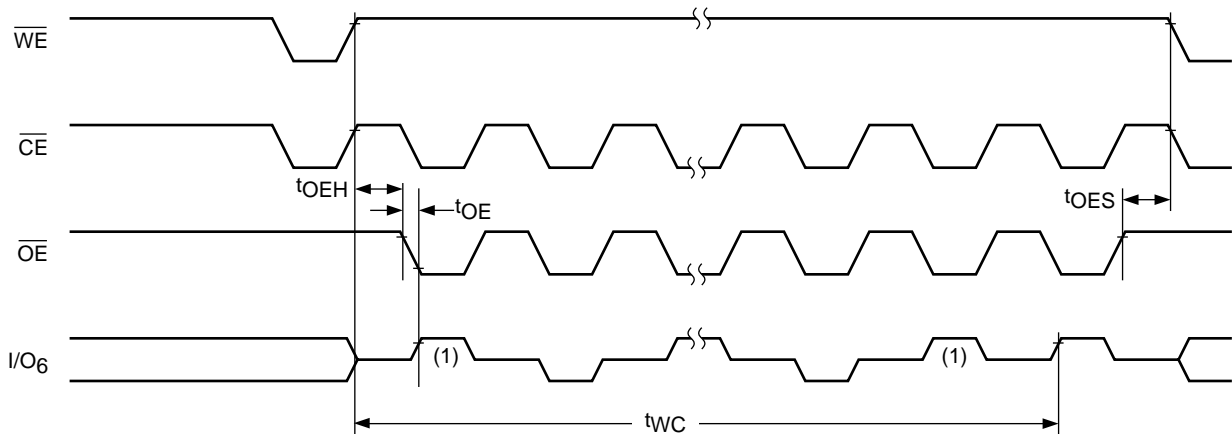

Figure 8. Toggle Bit



Note:

(1) Beginning and ending state of I/O₆ is indeterminate.

HARDWARE DATA PROTECTION

The following is a list of hardware data protection features that are incorporated into the CAT28C64B.

- (1) V_{CC} sense provides for write protection when V_{CC} falls below 3.5V min.
- (2) A power on delay mechanism, t_{INIT} (see AC characteristics), provides a 5 to 10 ms delay before a write sequence, after V_{CC} has reached 3.5V min.
- (3) Write inhibit is activated by holding any one of \overline{OE} low, \overline{CE} high or \overline{WE} high.

- (4) Noise pulses of less than 20 ns on the \overline{WE} or \overline{CE} inputs will not result in a write cycle.

SOFTWARE DATA PROTECTION

The CAT28C64B features a software controlled data protection scheme which, once enabled, requires a data algorithm to be issued to the device before a write can be performed. The device is shipped from Catalyst with the software protection NOT ENABLED (the CAT28C64B is in the standard operating mode).

Figure 9. Write Sequence for Activating Software Data Protection

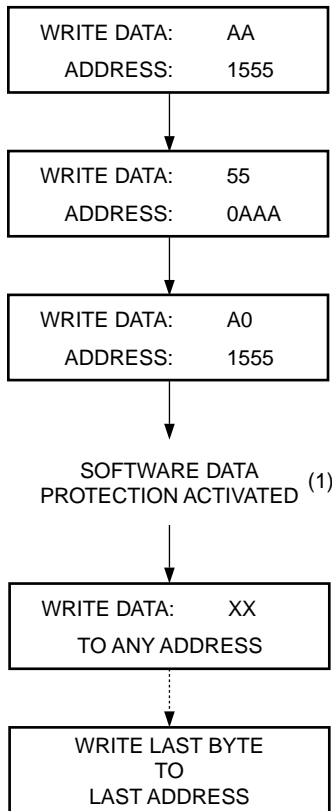
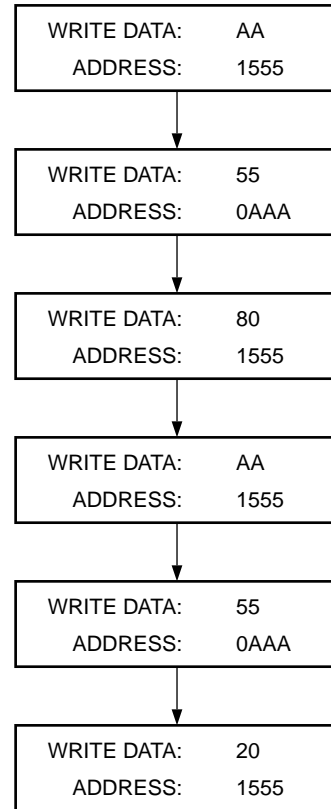

Figure 10. Write Sequence for Deactivating Software Data Protection



Note:

- (1) Write protection is activated at this point whether or not any more writes are completed. Writing to addresses must occur within t_{BLC} Max., after SDP activation.

To activate the software data protection, the device must be sent three write commands to specific addresses with specific data (Figure 9). This sequence of commands (along with subsequent writes) must adhere to the page write timing specifications (Figure 11). Once this is done, all subsequent byte or page writes to the device must be preceded by this same set of write commands. The data protection mechanism is activated until a deactivate sequence is issued regardless of power on/off transitions. This gives the user added inadvertent write protection on power-up in addition to the hardware protection provided.

To allow the user the ability to program the device with an EEPROM programmer (or for testing purposes) there is a software command sequence for deactivating the data protection. The six step algorithm (Figure 10) will reset the internal protection circuitry, and the device will return to standard operating mode (Figure 12 provides reset timing). After the sixth byte of this reset sequence has been issued, standard byte or page writing can commence.

Figure 11. Software Data Protection Timing

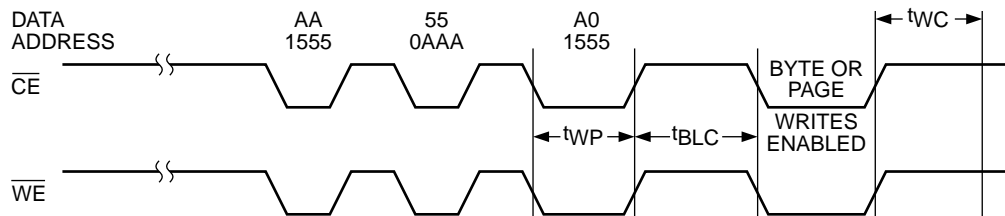
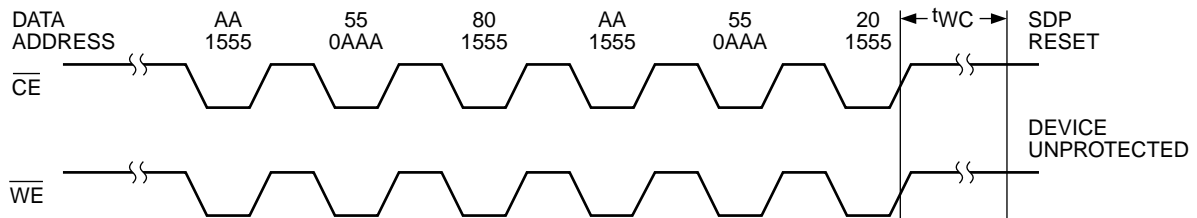
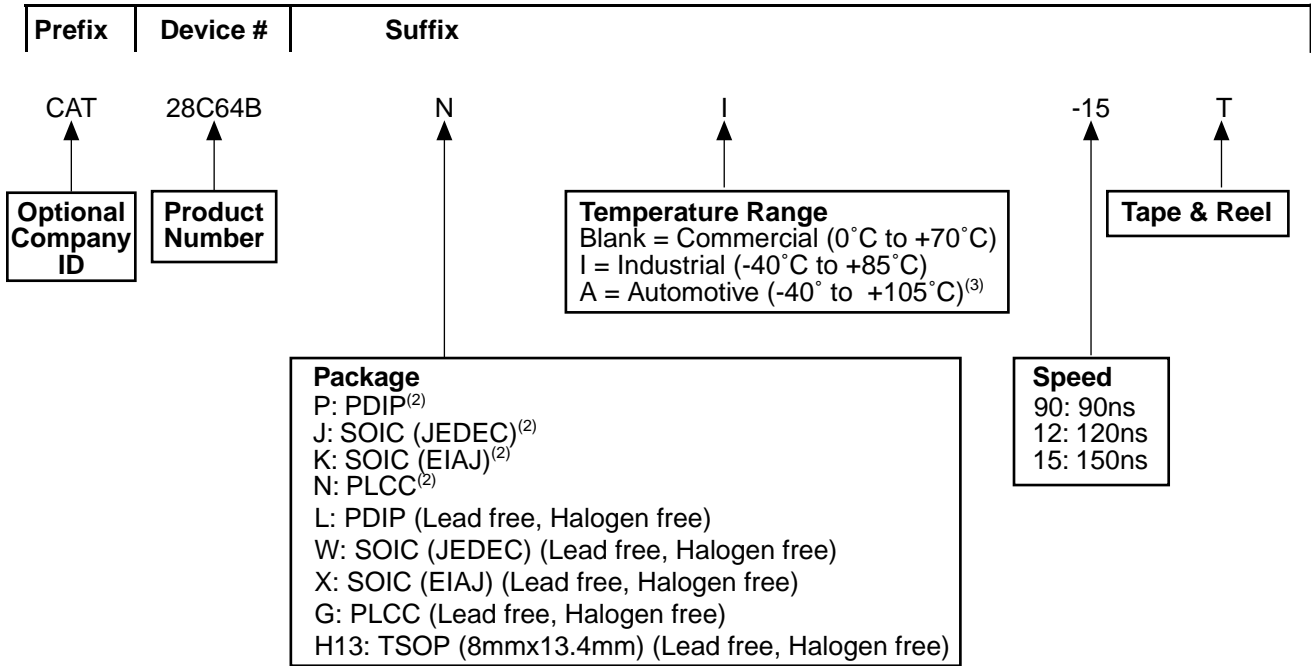

Figure 12. Resetting Software Data Protection Timing



Speed
90: 90ns
12: 120ns
15: 150ns

EXAMPLE OF ORDERING INFORMATION⁽¹⁾



ORDERING INFORMATION

Orderable Part Numbers (for Pb-Free Devices)	
CAT28C64BGI-12T	CAT28C64BLA12
CAT28C64BGI-15T	CAT28C64BLA15
CAT28C64BGI-90T	CAT28C64BLA90
CAT28C64BGA-12T	CAT28C64BWI-12T
CAT28C64BGA-15T	CAT28C64BWI-15T
CAT28C64BGA-90T	CAT28C64BWI-90T
CAT28C64BH13I12T	CAT28C64BWA-12T
CAT28C64BH13I15T	CAT28C64BWA-15T
CAT28C64BH13I90T	CAT28C64BWA-90T
CAT28C64BH13A12T	CAT28C64BXI-12T
CAT28C64BH13A15T	CAT28C64BXI-15T
CAT28C64BH13A90T	CAT28C64BXI-90T
CAT28C64BLI12	CAT28C64BXA-12T
CAT28C64BLI15	CAT28C64BXA-15T
CAT28C64BLI90	CAT28C64BXA-90T

Notes:

- (1) The device used in the above example is a CAT28C64BNI-15T (PLCC, Industrial temperature, 150 ns Access Time, Tape & Reel).
- (2) Solder-plate (tin-lead) packages, contact Factory for availability.
- (3) -40°C to +125°C is available upon request.

REVISION HISTORY

Date	Revision	Description
29-Mar-04	B	Added Green packages in all areas.
19-Apr-04	C	Delete data sheet designation Update Block Diagram Update Ordering Information Update Revision History Update Rev Number
16-Nov-04	D	Add 90: 90ns speed to Ordering Information
28-Feb-05	E	Edit Ordering Information
18-Mar-05	F	Edit Description
15-Oct-08	G	Eliminate TSOP (8mm x 13.4mm) SnPb package.
19-Nov-08	H	Change logo and fine print to ON Semiconductor
28-Jul-09	I	Update Example of Ordering Information Update Ordering Information table

ON Semiconductor and  are registered trademarks of Semiconductor Components Industries, LLC (SCILLC). SCILLC reserves the right to make changes without further notice to any products herein. SCILLC makes no warranty, representation or guarantee regarding the suitability of its products for any particular purpose, nor does SCILLC assume any liability arising out of the application or use of any product or circuit, and specifically disclaims any and all liability, including without limitation special, consequential or incidental damages. "Typical" parameters which may be provided in SCILLC data sheets and/or specifications can and do vary in different applications and actual performance may vary over time. All operating parameters, including "Typicals" must be validated for each customer application by customer's technical experts. SCILLC does not convey any license under its patent rights nor the rights of others. SCILLC products are not designed, intended, or authorized for use as components in systems intended for surgical implant into the body, or other applications intended to support or sustain life, or for any other application in which the failure of the SCILLC product could create a situation where personal injury or death may occur. Should Buyer purchase or use SCILLC products for any such unintended or unauthorized application, Buyer shall indemnify and hold SCILLC and its officers, employees, subsidiaries, affiliates, and distributors harmless against all claims, costs, damages, and expenses, and reasonable attorney fees arising out of, directly or indirectly, any claim of personal injury or death associated with such unintended or unauthorized use, even if such claim alleges that SCILLC was negligent regarding the design or manufacture of the part. SCILLC is an Equal Opportunity/Affirmative Action Employer. This literature is subject to all applicable copyright laws and is not for resale in any manner.

PUBLICATION ORDERING INFORMATION

LITERATURE FULFILLMENT:

Literature Distribution Center for ON Semiconductor
P.O. Box 5163, Denver, Colorado 80217 USA
Phone: 303-675-2175 or 800-344-3860 Toll Free USA/Canada
Fax: 303-675-2176 or 800-344-3867 Toll Free USA/Canada
Email: orderlit@onsemi.com

N. American Technical Support: 800-282-9855
Toll Free
USA/Canada

Europe, Middle East and Africa Technical Support:
Phone: 421 33 790 2910

Japan Customer Focus Center:
Phone: 81-3-5773-3850

ON Semiconductor Website: www.onsemi.com

Order Literature: <http://www.onsemi.com/orderlit>

For additional information, please contact your local Sales Representative

Looking for pricing, stock, or lifecycle information?

Click below to explore more details on WIN SOURCE:

 [View CAT28C64BLI12](#) on WIN SOURCE

 [ON Semiconductor](#) Information

Optimize Your Supply Chain with WIN SOURCE Solutions

-  Global Sourcing Solution
-  Obsolete Management
-  Cost Control Management
-  Shortage Management
-  Alternative Solution
-  Excess Inventory Management