



**THE DATASHEET OF  
C2012C0G2E152J085AA**



# DELIVERY SPECIFICATION

SPEC. No. C-General-f

D A T E : Aug,2019

To

**Non-Controlled Copy**

<p>CUSTOMER'S PRODUCT NAME</p>	<p>TDK'S PRODUCT NAME                  Multilayer Ceramic Chip Capacitors                  Bulk and tape packaging <b>【RoHS compliant】</b>                  C1005,C1608,C2012,C3216,C3225,                  C4532,C5750 Type                  C0G,CH,X5R,X6S,X7R,X7S,X7T,B Characteristics</p>
--------------------------------	--

Please return this specification to TDK representatives with your signature.  
 If orders are placed without returned specification, please allow us to judge that specification is accepted by your side.

## RECEIPT CONFIRMATION

DATE: \_\_\_\_\_ YEAR \_\_\_\_\_ MONTH \_\_\_\_\_ DAY \_\_\_\_\_

TDK Corporation  
 Sales  
 Electronic Components  
 Sales & Marketing Group

Engineering  
 Electronic Components Business Company  
 Ceramic Capacitors Business Group

APPROVED	Person in charge

APPROVED	CHECKED	Person in charge

## CATALOG NUMBER CONSTRUCTION

<b>C</b>	<b>3216</b>	<b>X5R</b>	<b>1A</b>	<b>107</b>	<b>M</b>	<b>160</b>	<b>A</b>	<b>C</b>
(1)	(2)	(3)	(4)	(5)	(6)	(7)	(8)	(9)

### (1) Series

### (2) Dimensions L x W (mm)

Code	EIA	Length	Width	Terminal width
0402	CC01005	0.40	0.20	0.07
0603	CC0201	0.60	0.30	0.10
1005	CC0402	1.00	0.50	0.10
1608	CC0603	1.60	0.80	0.20
2012	CC0805	2.00	1.25	0.20
3216	CC1206	3.20	1.60	0.20
3225	CC1210	3.20	2.50	0.20
4532	CC1812	4.50	3.20	0.20
5750	CC2220	5.70	5.00	0.20

### (3) Temperature characteristics

Temperature characteristics	Temperature coefficient or capacitance change	Temperature range
CH	0±60 ppm/°C	-25 to +85°C
C0G	0±30 ppm/°C	-55 to +125°C
JB	±10%	-25 to +85°C
X5R	±15%	-55 to +85°C
X6S	±22%	-55 to +105°C
X7R	±15%	-55 to +125°C
X7S	±22%	-55 to +125°C

### (4) Rated voltage (DC)

Code	Voltage (DC)
0G	4V
0J	6.3V
1A	10V
1C	16V
1E	25V
1V	35V
1H	50V
1N	75V

### (5) Nominal capacitance (pF)

The capacitance is expressed in three digit codes and in units of pico Farads (pF). The first and second digits identify the first and second significant figures of the capacitance. The third digit identifies the multiplier. R designates a decimal point.

(Example)0R5 = 0.5pF

101 = 100pF

225 = 2,200,000pF = 2.2μF

### (6) Capacitance tolerance

Code	Tolerance
B	±0.10pF
C	±0.25pF
D	±0.50pF
F	±1%
G	±2%
J	±5%
K	±10%
M	±20%

### (7) Thickness

Code	Thickness
020	0.20 mm
030	0.30 mm
050	0.50 mm
060	0.60 mm
080	0.80 mm
085	0.85 mm
115	1.15 mm
125	1.25 mm
130	1.30 mm
160	1.60 mm
200	2.00 mm
230	2.30 mm
250	2.50 mm
280	2.80 mm
320	3.20 mm

### (8) Packaging style

Code	Style
A	178mm reel, 4mm pitch
B	178mm reel, 2mm pitch
K	178mm reel, 8mm pitch

### (9) Special reserved code

Code	Description
A, B, C	TDK internal code

## CATALOG NUMBER CONSTRUCTION

<b>C</b>	<b>5750</b>	<b>X7S</b>	<b>2A</b>	<b>226</b>	<b>M</b>	<b>280</b>	<b>K</b>	<b>B</b>
(1)	(2)	(3)	(4)	(5)	(6)	(7)	(8)	(9)

### (1) Series

### (2) Dimensions L x W (mm)

Code	EIA	Length	Width	Terminal width
1005	CC0402	1.00	0.50	0.10
1608	CC0603	1.60	0.80	0.20
2012	CC0805	2.00	1.25	0.20
3216	CC1206	3.20	1.60	0.20
3225	CC1210	3.20	2.50	0.20
4532	CC1812	4.50	3.20	0.20
5750	CC2220	5.70	5.00	0.20

### (3) Temperature characteristics

Temperature characteristics	Temperature coefficient or capacitance change	Temperature range
CH	0±60 ppm/°C	-25 to +85°C
C0G	0±30 ppm/°C	-55 to +125°C
JB	±10%	-25 to +85°C
X5R	±15%	-55 to +85°C
X6S	±22%	-55 to +105°C
X7R	±15%	-55 to +125°C
X7S	±22%	-55 to +125°C
X7T	+22,-33%	-55 to +125°C

### (4) Rated voltage (DC)

Code	Voltage (DC)
2A	100V
2E	250V
2V	350V
2W	450V
2J	630V

### (5) Nominal capacitance (pF)

The capacitance is expressed in three digit codes and in units of pico Farads (pF). The first and second digits identify the first and second significant figures of the capacitance. The third digit identifies the multiplier. R designates a decimal point.

(Example) 0R5 = 0.5pF  
 101 = 10pF  
 225 = 2,200,000pF = 2.2μF

### (6) Capacitance tolerance

Code	Tolerance
C	±0.25pF
D	±0.50pF
F	±1%
G	±2%
J	±5%
K	±10%
M	±20%

### (7) Thickness

Code	Thickness
050	0.50 mm
060	0.60 mm
080	0.80 mm
085	0.85 mm
115	1.15 mm
125	1.25 mm
130	1.30 mm
160	1.60 mm
200	2.00 mm
230	2.30 mm
250	2.50 mm
280	2.80 mm
320	3.20 mm

### (8) Packaging style

Code	Style
A	178mm reel, 4mm pitch
B	178mm reel, 2mm pitch
K	178mm reel, 8mm pitch

### (9) Special reserved code

Code	Description
A, B, C, N	TDK internal code

**SCOPE**

This delivery specification shall be applied to Multilayer ceramic chip capacitors to be delivered to \_\_\_\_\_.

**PRODUCTION PLACES**

Production places defined in this specification shall be TDK Corporation, TDK(Suzhou)Co.,Ltd and TDK Components U.S.A.,Inc.

**PRODUCT NAME**

The name of the product to be defined in this specifications shall be C◇◇◇◇○○○△△□□□×.

**REFERENCE STANDARD**

- JIS C 5101-1 : 2010 Fixed capacitors for use in electronic equipment-Part 1: Generic specification  
 C 5101-21 : 2014 Fixed capacitors for use in electronic equipment-Part 21 : Sectional specification : Fixed surface mount multilayer capacitors of ceramic dielectric,Class1  
 C 5101-22 : 2014 Fixed capacitors for use in electronic equipment-Part 22 : Sectional specification : Fixed surface mount multilayer capacitors of ceramic dielectric,Class2  
 C 0806-3 : 2014 Packaging of components for automatic handling - Part 3: Packaging of surface mount components on continuous tapes  
 JEITA RCR-2335 C 2014 Safety application guide for fixed ceramic capacitors for use in electronic equipment

**CONTENTS**

1. CODE CONSTRUCTION
2. COMBINATION OF RATED CAPACITANCE AND TOLERANCE
3. OPERATING TEMPERATURE RANGE
4. STORING CONDITION AND TERM
5. P.C. BOARD
6. INDUSTRIAL WASTE DISPOSAL
7. PERFORMANCE
8. INSIDE STRUCTURE AND MATERIAL
9. PACKAGING
10. RECOMMENDATION
11. SOLDERING CONDITION
12. CAUTION
13. TAPE PACKAGING SPECIFICATION

**<EXPLANATORY NOTE>**

When the mistrust in the spec arises, this specification is given priority. And it will be confirmed by written spec change after conference of both posts involved.

This specification warrants the quality of the ceramic chip capacitor. Capacitors should be evaluated or confirmed a state of mounted on your product.

If the use of the capacitors goes beyond the bounds of this specification, we can not afford to guarantee.

Division	Date	SPEC. No.
Ceramic Capacitors Business Group	Aug, 2019	C-General-f

## 1. CODE CONSTRUCTION

(Example) C2012 X7R 1E 225 K T 0000  
 (1) (2) (3) (4) (5) (6) (7)

(1) Case size



Case size [EIA style]	Dimensions (mm)				
	L	W	T	B	G
C1005 [CC0402]	1.00±0.05	0.50±0.05	0.50±0.05	0.10 min.	0.30 min.
	1.00±0.10	0.50±0.10	0.50±0.10		
	1.00 <sup>+0.15</sup> <sub>-0.10</sub>	0.50 <sup>+0.15</sup> <sub>-0.10</sub>	0.50 <sup>+0.15</sup> <sub>-0.10</sub>		
C1608 [CC0603]	1.60±0.10	0.80±0.10	0.80±0.10	0.20 min.	0.30 min.
	1.60 <sup>+0.15</sup> <sub>-0.10</sub>	0.80 <sup>+0.15</sup> <sub>-0.10</sub>	0.80 <sup>+0.15</sup> <sub>-0.10</sub>		
	1.60 <sup>+0.20</sup> <sub>-0.10</sub>	0.80 <sup>+0.20</sup> <sub>-0.10</sub>	0.80 <sup>+0.20</sup> <sub>-0.10</sub>		
C2012 [CC0805]	2.00±0.20	1.25±0.20	0.60±0.15	0.20 min.	0.50 min.
			0.85±0.15		
			1.25±0.20		
	2.00 <sup>+0.25</sup> <sub>-0.15</sub>	1.25 <sup>+0.25</sup> <sub>-0.15</sub>	1.25 <sup>+0.25</sup> <sub>-0.15</sub>		
C3216 [CC1206]	3.20±0.20	1.60±0.20	0.60±0.15	0.20 min.	1.00 min.
			0.85±0.15		
			1.15±0.15		
			1.30±0.20		
			1.60±0.20		
	3.20 <sup>+0.30</sup> <sub>-0.10</sub>	1.60 <sup>+0.30</sup> <sub>-0.10</sub>	1.60 <sup>+0.30</sup> <sub>-0.10</sub>		
C3225 [CC1210]	3.20±0.40	2.50±0.30	1.25±0.20	0.20 min.	—
			1.60±0.20		
			2.00±0.20		
			2.30±0.20		
			2.50±0.30		
C4532 [CC1812]	4.50±0.40	3.20±0.40	1.60±0.20	0.20 min.	—
			2.00±0.20		
			2.30±0.20		
			2.50±0.30		
			2.80±0.30		
C5750 [CC2220]	5.70±0.40	5.00±0.40	1.60±0.20	0.20 min.	—
			2.00±0.20		
			2.30±0.20		
			2.50±0.30		
			2.80±0.30		

\* As for each item, please refer to detail page on TDK Web.

## (2) Temperature Characteristics

\* Details are shown in table 1 No.6 and No.7 at 7.PERFORMANCE

## (3) Rated Voltage

Symbol	Rated Voltage	Symbol	Rated Voltage
2 J	DC 630 V	1 V	DC 35 V
2 W	DC 450 V	1 E	DC 25 V
2 V	DC 350 V	1 C	DC 16 V
2 E	DC 250 V	1 A	DC 10 V
2 A	DC 100 V	0 J	DC 6.3 V
1 N	DC 75 V	0 G	DC 4 V
1 H	DC 50 V		

## (4) Rated Capacitance

Stated in three digits and in units of pico farads (pF).  
The first and Second digits identify the first and second significant figures of the capacitance, the third digit identifies the multiplier.  
R is designated for a decimal point.

(Example)

Symbol	Rated Capacitance
2R2	2.2 pF
225	2,200,000 pF

## (5) Capacitance tolerance

\* M tolerance shall be standard for over 10uF.

Symbol	Tolerance	Capacitance
C	± 0.25 pF	10pF and under
D	± 0.5 pF	
J	± 5 %	Over 10pF
K	± 10 %	
* M	± 20 %	

## (6) Packaging

\* C1005 type is applicable to tape packaging only.

Symbol	Packaging
B	Bulk
T	Taping

## (7) TDK internal code

## 2. COMBINATION OF RATED CAPACITANCE AND TOLERANCE

Class	Temperature Characteristics	Capacitance tolerance		Rated capacitance
1	C0G CH	10pF and under	C ( $\pm 0.25\text{pF}$ )	1, 2, 3, 4, 5
			D ( $\pm 0.5\text{pF}$ )	6, 7, 8, 9, 10
		Over 10pF	J ( $\pm 5\%$ )	E – 6 series E – 12 series
2	X5R X6S X7R X7S X7T B	10uF and under	K ( $\pm 10\%$ ) M ( $\pm 20\%$ )	E – 6 series
		Over 10uF	M ( $\pm 20\%$ )	

Capacitance Step in E series

E series	Capacitance Step											
E-6	1.0		1.5		2.2		3.3		4.7		6.8	
E-12	1.0	1.2	1.5	1.8	2.2	2.7	3.3	3.9	4.7	5.6	6.8	8.2

## 3. OPERATING TEMPERATURE RANGE

T.C.	Min. operating Temperature	Max. operating Temperature	Reference Temperature
CH/B	-25°C	85°C	20°C
X5R	-55°C	85°C	25°C
X6S	-55°C	105°C	25°C
C0G/X7R/X7S/X7T	-55°C	125°C	25°C

## 4. STORING CONDITION AND TERM

Storing temperature	Storing humidity	Storing term
5~40°C	20~70%RH	Within 6 months upon receipt.

## 5. P.C. BOARD

When mounting on an aluminum substrate, large case sizes such as C3225[CC1210] and larger are more likely to be affected by heat stress from the substrate. Please inquire separate specification for the large case sizes when mounted on the substrate.

## 6. INDUSTRIAL WASTE DISPOSAL

Dispose this product as industrial waste in accordance with the Industrial Waste Law.

## 7. PERFORMANCE

table 1

No.	Item		Performance	Test or inspection method																	
1	External Appearance		No defects which may affect performance.	Inspect with magnifying glass (3×)																	
2	Insulation Resistance		Please refer to detail page on TDK Web.	Measuring voltage : Rated voltage (As for the capacitor of rated voltage 630V DC, apply 500V DC.) Voltage application time : 60s.																	
3	Voltage Proof		Withstand test voltage without insulation breakdown or other damage.	<table border="1"> <thead> <tr> <th>Class</th> <th>Rated voltage(RV)</th> <th>Apply voltage</th> </tr> </thead> <tbody> <tr> <td rowspan="3">1</td> <td><math>RV \leq 100V</math></td> <td>3 × rated voltage</td> </tr> <tr> <td><math>100V &lt; RV \leq 500V</math></td> <td>1.5 × rated voltage</td> </tr> <tr> <td><math>500V &lt; RV</math></td> <td>1.3 × rated voltage</td> </tr> <tr> <td rowspan="3">2</td> <td><math>RV \leq 100V</math></td> <td>2.5 × rated voltage</td> </tr> <tr> <td><math>100V &lt; RV \leq 500V</math></td> <td>1.5 × rated voltage</td> </tr> <tr> <td><math>500V &lt; RV</math></td> <td>1.3 × rated voltage</td> </tr> </tbody> </table> <p>Voltage application time : 1s. Charge / discharge current : 50mA or lower</p>	Class	Rated voltage(RV)	Apply voltage	1	$RV \leq 100V$	3 × rated voltage	$100V < RV \leq 500V$	1.5 × rated voltage	$500V < RV$	1.3 × rated voltage	2	$RV \leq 100V$	2.5 × rated voltage	$100V < RV \leq 500V$	1.5 × rated voltage	$500V < RV$	1.3 × rated voltage
Class	Rated voltage(RV)	Apply voltage																			
1	$RV \leq 100V$	3 × rated voltage																			
	$100V < RV \leq 500V$	1.5 × rated voltage																			
	$500V < RV$	1.3 × rated voltage																			
2	$RV \leq 100V$	2.5 × rated voltage																			
	$100V < RV \leq 500V$	1.5 × rated voltage																			
	$500V < RV$	1.3 × rated voltage																			
4	Capacitance		Within the specified tolerance.	As for measuring condition, please refer to the TABLE A.																	
5	Q	Class1	Please refer to detail page on TDK Web.	See No.4 in this table for measuring condition.																	
	Dissipation Factor	Class2																			

(continued)

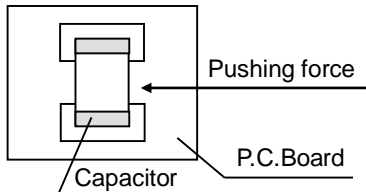
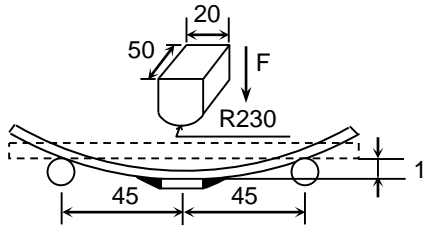
No.	Item	Performance	Test or inspection method																					
6	Temperature Characteristics of Capacitance (Class1)	<table border="1"> <tr> <td>T.C.</td> <td>Temperature Coefficient (ppm/°C)</td> </tr> <tr> <td>C0G</td> <td>0 ± 30</td> </tr> <tr> <td>CH</td> <td>0 ± 60</td> </tr> <tr> <td>Capacitance drift</td> <td>Within ± 0.2% or ± 0.05pF, whichever larger.</td> </tr> </table>	T.C.	Temperature Coefficient (ppm/°C)	C0G	0 ± 30	CH	0 ± 60	Capacitance drift	Within ± 0.2% or ± 0.05pF, whichever larger.	<p>Temperature coefficient shall be calculated based on values at 25°C(CH:20°C) and 85°C temperature.</p> <p>Measuring temperature below 25°C(CH:20°C) shall be -10°C and -25°C.</p>													
T.C.	Temperature Coefficient (ppm/°C)																							
C0G	0 ± 30																							
CH	0 ± 60																							
Capacitance drift	Within ± 0.2% or ± 0.05pF, whichever larger.																							
7	Temperature Characteristics of Capacitance (Class2)	<table border="1"> <tr> <th colspan="2">Capacitance Change (%)</th> </tr> <tr> <th>No voltage applied</th> <th>With voltage Applied</th> </tr> <tr> <td>X5R : ±15</td> <td rowspan="6">Please contact with our sales representative.</td> </tr> <tr> <td>X6S : ±22</td> </tr> <tr> <td>X7R : ±15</td> </tr> <tr> <td>X7S : ±22</td> </tr> <tr> <td>X7T : +22 - 33</td> </tr> <tr> <td>B : ±10</td> </tr> </table>	Capacitance Change (%)		No voltage applied	With voltage Applied	X5R : ±15	Please contact with our sales representative.	X6S : ±22	X7R : ±15	X7S : ±22	X7T : +22 - 33	B : ±10	<p>Capacitance shall be measured by the steps shown in the following table after thermal equilibrium is obtained for each step. <math>\Delta C</math> be calculated ref. STEP3 reading</p> <table border="1"> <tr> <th>Step</th> <th>Temperature(°C)</th> </tr> <tr> <td>1</td> <td>Reference temp. ± 2</td> </tr> <tr> <td>2</td> <td>Min. operating temp. ± 2</td> </tr> <tr> <td>3</td> <td>Reference temp. ± 2</td> </tr> <tr> <td>4</td> <td>Max. operating temp. ± 2</td> </tr> </table> <p>As for Min./Max operating temp and Reference temp., please refer to "3. OPERATING TEMPERATURE RANGE" Apply a voltage of 1/2 rated voltage. As for measuring voltage, please contact with our sales representative.</p>	Step	Temperature(°C)	1	Reference temp. ± 2	2	Min. operating temp. ± 2	3	Reference temp. ± 2	4	Max. operating temp. ± 2
Capacitance Change (%)																								
No voltage applied	With voltage Applied																							
X5R : ±15	Please contact with our sales representative.																							
X6S : ±22																								
X7R : ±15																								
X7S : ±22																								
X7T : +22 - 33																								
B : ±10																								
Step	Temperature(°C)																							
1	Reference temp. ± 2																							
2	Min. operating temp. ± 2																							
3	Reference temp. ± 2																							
4	Max. operating temp. ± 2																							
8	Robustness of Terminations	No sign of termination coming off, breakage of ceramic, or other abnormal signs.	<p>Reflow solder the capacitors on a P.C.Board shown in Appendix 2.</p> <p>Apply a pushing force gradually at the center of a specimen in a horizontal direction of P.C.board.</p> <p>Pushing force : 5N (2N is applied for C1005 type.) Holding time : 10±1s</p> 																					
9	Bending	No mechanical damage.	<p>Reflow solder the capacitors on a P.C.Board shown in Appendix1 and bend it for 1mm.</p>  <p>(Unit : mm)</p>																					

(continued)

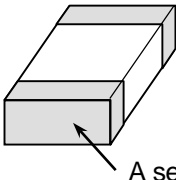
No.	Item	Performance	Test or inspection method																					
10	Solderability	<p>New solder to cover over 75% of termination.</p> <p>25% may have pin holes or rough spots but not concentrated in one spot.</p> <p>Ceramic surface of A sections shall not be exposed due to melting or shifting of termination material.</p> 	<p>Solder : Sn-3.0Ag-0.5Cu or Sn-37Pb</p> <p>Flux : Isopropyl alcohol (JIS K 8839) Rosin (JIS K 5902) 25% solid solution.</p> <p>Solder temp. : 245±5°C (Sn-3.0Ag-0.5Cu) 235±5°C (Sn-37Pb)</p> <p>Dwell time : 3±0.3s.(Sn-3.0Ag-0.5Cu) 2±0.2s.(Sn-37Pb)</p> <p>Solder position : Until both terminations are completely soaked.</p>																					
11	Resistance to solder heat	<table border="1"> <tr> <td>External appearance</td> <td>No cracks are allowed and terminations shall be covered at least 60% with new solder.</td> </tr> <tr> <td>Capacitance</td> <td> <table border="1"> <thead> <tr> <th colspan="2">Characteristics</th> <th>Change from the value before test</th> </tr> </thead> <tbody> <tr> <td>Class 1</td> <td>C0G CH</td> <td>Capacitance drift within ±2.5% or ±0.25pF, whichever larger.</td> </tr> <tr> <td>Class 2</td> <td>X5R X6S X7R X7S X7T B</td> <td>± 7.5 %</td> </tr> </tbody> </table> </td> </tr> <tr> <td>Q (Class1)</td> <td>Meet the initial spec.</td> </tr> <tr> <td>D.F. (Class2)</td> <td>Meet the initial spec.</td> </tr> <tr> <td>Insulation Resistance</td> <td>Meet the initial spec.</td> </tr> <tr> <td>Voltage proof</td> <td>No insulation breakdown or other damage.</td> </tr> </table>	External appearance	No cracks are allowed and terminations shall be covered at least 60% with new solder.	Capacitance	<table border="1"> <thead> <tr> <th colspan="2">Characteristics</th> <th>Change from the value before test</th> </tr> </thead> <tbody> <tr> <td>Class 1</td> <td>C0G CH</td> <td>Capacitance drift within ±2.5% or ±0.25pF, whichever larger.</td> </tr> <tr> <td>Class 2</td> <td>X5R X6S X7R X7S X7T B</td> <td>± 7.5 %</td> </tr> </tbody> </table>	Characteristics		Change from the value before test	Class 1	C0G CH	Capacitance drift within ±2.5% or ±0.25pF, whichever larger.	Class 2	X5R X6S X7R X7S X7T B	± 7.5 %	Q (Class1)	Meet the initial spec.	D.F. (Class2)	Meet the initial spec.	Insulation Resistance	Meet the initial spec.	Voltage proof	No insulation breakdown or other damage.	<p>Solder : Sn-3.0Ag-0.5Cu or Sn-37Pb</p> <p>Flux : Isopropyl alcohol (JIS K 8839) Rosin (JIS K 5902) 25% solid solution.</p> <p>Solder temp. : 260±5°C</p> <p>Dwell time : 10±1s.</p> <p>Solder position : Until both terminations are completely soaked.</p> <p>Pre-heating : Temp. — 110~140°C Time — 30~60s.</p> <p>Leaving time : Class1 — 6~24h Class2 — 24±2h</p>
External appearance	No cracks are allowed and terminations shall be covered at least 60% with new solder.																							
Capacitance	<table border="1"> <thead> <tr> <th colspan="2">Characteristics</th> <th>Change from the value before test</th> </tr> </thead> <tbody> <tr> <td>Class 1</td> <td>C0G CH</td> <td>Capacitance drift within ±2.5% or ±0.25pF, whichever larger.</td> </tr> <tr> <td>Class 2</td> <td>X5R X6S X7R X7S X7T B</td> <td>± 7.5 %</td> </tr> </tbody> </table>	Characteristics		Change from the value before test	Class 1	C0G CH	Capacitance drift within ±2.5% or ±0.25pF, whichever larger.	Class 2	X5R X6S X7R X7S X7T B	± 7.5 %														
Characteristics		Change from the value before test																						
Class 1	C0G CH	Capacitance drift within ±2.5% or ±0.25pF, whichever larger.																						
Class 2	X5R X6S X7R X7S X7T B	± 7.5 %																						
Q (Class1)	Meet the initial spec.																							
D.F. (Class2)	Meet the initial spec.																							
Insulation Resistance	Meet the initial spec.																							
Voltage proof	No insulation breakdown or other damage.																							

(continued)

No.	Item		Performance	Test or inspection method															
12	Vibration	External appearance	No mechanical damage.	Frequency : 10~55~10Hz Reciprocating sweep time : 1 min. Amplitude : 1.5mm Repeat this for 2h each in 3 perpendicular directions(Total 6h).  Reflow solder the capacitors on a P.C.Board shown in Appendix 2 before testing.															
		Capacitance	Characteristics		Change from the value before test														
			Class1		C0G CH	$\pm 2.5\%$ or $\pm 0.25\text{pF}$ , whichever larger.													
			Class2		X5R X6S X7R X7S X7T B	$\pm 7.5\%$													
		Q (Class1)	Meet the initial spec.																
D.F. (Class2)	Meet the initial spec.																		
13	Temperature cycle	External appearance	No mechanical damage.	Expose the capacitors in the condition step1 through step 4 listed in the following table.  Temp. cycle : 5 cycles <table border="1" data-bbox="986 1064 1477 1400"> <thead> <tr> <th>Step</th> <th>Temperature(°C)</th> <th>Time (min.)</th> </tr> </thead> <tbody> <tr> <td>1</td> <td>Min. operating temp.<math>\pm 3</math></td> <td><math>30 \pm 3</math></td> </tr> <tr> <td>2</td> <td>Ambient Temp.</td> <td>2 ~ 5</td> </tr> <tr> <td>3</td> <td>Max. operating temp.<math>\pm 2</math></td> <td><math>30 \pm 2</math></td> </tr> <tr> <td>4</td> <td>Ambient Temp.</td> <td>2 ~ 5</td> </tr> </tbody> </table> As for Min./Max operating temp., please refer to "3. OPERATING TEMPERATURE RANGE"  Leaving time : Class1 — 6~24h Class2 — 24 $\pm$ 2h  Reflow solder the capacitors on a P.C.Board shown in Appendix2 before testing.	Step	Temperature(°C)	Time (min.)	1	Min. operating temp. $\pm 3$	$30 \pm 3$	2	Ambient Temp.	2 ~ 5	3	Max. operating temp. $\pm 2$	$30 \pm 2$	4	Ambient Temp.	2 ~ 5
		Step	Temperature(°C)		Time (min.)														
		1	Min. operating temp. $\pm 3$		$30 \pm 3$														
		2	Ambient Temp.		2 ~ 5														
		3	Max. operating temp. $\pm 2$		$30 \pm 2$														
		4	Ambient Temp.		2 ~ 5														
		Capacitance	Characteristics		Change from the value before test														
Class1	C0G CH		Please contact with our sales representative.																
Class2	X5R X6S X7R X7S X7T B																		
Q (Class1)	Meet the initial spec.																		
D.F. (Class2)	Meet the initial spec.																		
Insulation Resistance	Meet the initial spec.																		
Voltage proof	No insulation breakdown or other damage.																		

(continued)

No.	Item		Performance	Test or inspection method
14	Moisture Resistance (Steady State)	External appearance	No mechanical damage.	Test temp. : 40±2°C Test humidity : 90~95%RH Test time : 500 +24,0h Leaving time : Class1 — 6~24h Class2 — 24±2h  Reflow solder the capacitors on a P.C.Board shown in Appendix2 before testing.
		Capacitance	Characteristics	
	Class1		C0G CH	
	Class2		X5R X6S X7R X7S X7T B	
	Q (Class1)	Capacitance	Q	
30pF and over		350 min.		
10pF and over under 30pF		275+5/2×C min.		
Under 10pF		200+10×C min.		
C : Rated capacitance (pF)				
D.F. (Class2)	200% of initial spec. max.			
Insulation Resistance	Please refer to the TABLE A in the end of the specification.  SPEC type A : 1,000MΩ or 50MΩ·μF min., whichever smaller.  SPEC type B : 1,000 MΩ or 10MΩ·μF min., whichever smaller.			



(continued)

No.	Item	Performance	Test or inspection method														
16	Life																
	External appearance	No mechanical damage.	Test temp. : Maximum operating temperature $\pm 2^{\circ}\text{C}$ Applied voltage : Please contact with our sales representative. Test time : 1,000 +48,0h Charge/discharge current : 50mA or lower Leaving time : Class1 — 6~24h Class2 — 24 $\pm$ 2h  Reflow solder the capacitors on a P.C.Board shown in Appendix2 before testing.  Initial value setting (only for class 2) Voltage conditioning «After voltage treat the capacitors under testing temperature and voltage for 1 hour,» leave the capacitors in ambient condition for 24 $\pm$ 2h before measurement. Use this measurement for initial value.														
	Capacitance	<table border="1"> <thead> <tr> <th colspan="2">Characteristics</th> <th>Change from the value before test</th> </tr> </thead> <tbody> <tr> <td>Class1</td> <td>C0G CH</td> <td rowspan="5">Please contact with our sales representative.</td> </tr> <tr> <td rowspan="4">Class2</td> <td>X5R</td> </tr> <tr> <td>X6S</td> </tr> <tr> <td>X7R</td> </tr> <tr> <td>X7S</td> </tr> <tr> <td>X7T</td> </tr> <tr> <td>B</td> <td></td> </tr> </tbody> </table>		Characteristics		Change from the value before test	Class1	C0G CH	Please contact with our sales representative.	Class2	X5R	X6S	X7R	X7S	X7T	B	
	Characteristics			Change from the value before test													
	Class1	C0G CH		Please contact with our sales representative.													
Class2	X5R																
	X6S																
	X7R																
	X7S																
X7T																	
B																	
Q (Class1)	<table border="1"> <thead> <tr> <th>Capacitance</th> <th>Q</th> </tr> </thead> <tbody> <tr> <td>30pF and over</td> <td>350 min.</td> </tr> <tr> <td>10pF and over under 30pF</td> <td>275+5/2xC min.</td> </tr> <tr> <td>Under 10pF</td> <td>200+10xC min.</td> </tr> </tbody> </table> C : Rated capacitance (pF)	Capacitance	Q	30pF and over	350 min.	10pF and over under 30pF	275+5/2xC min.	Under 10pF	200+10xC min.								
Capacitance	Q																
30pF and over	350 min.																
10pF and over under 30pF	275+5/2xC min.																
Under 10pF	200+10xC min.																
D.F. (Class2)	200% of initial spec. max.																
Insulation Resistance	Please refer to the TABLE A in the end of the specification.  SPEC type A : 1,000M $\Omega$ or 50M $\Omega$ · $\mu\text{F}$ min., whichever smaller.  SPEC type B : 1,000 M $\Omega$ or 10M $\Omega$ · $\mu\text{F}$ min., whichever smaller.																

\*As for the initial measurement of capacitors (Class2) on number 7,11,12,13 and 14, leave capacitors at 150 0,-10°C for 1 hour and measure the value after leaving capacitors for 24  $\pm$  2h in ambient condition.

### Appendix1 P.C.Board for bending test



### Appendix2 P.C. Board for reliability test

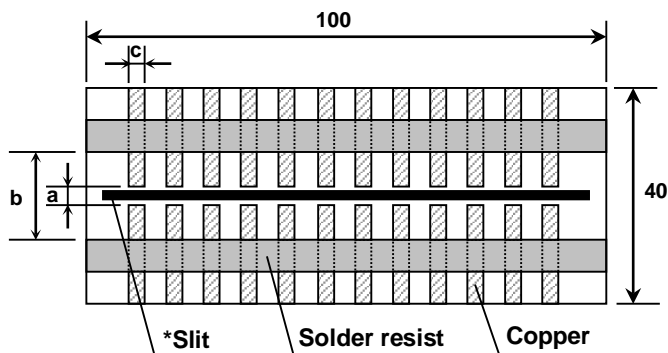

\* It is recommended to provide a slit on P.C.Board for C3225,C4532 and C5750.

(Unit : mm)

Case size / Symbol	a	b	c
C1005 [CC0402]	0.4	1.5	0.5
C1608 [CC0603]	1.0	3.0	1.2
C2012 [CC0805]	1.2	4.0	1.65
C3216 [CC1206]	2.2	5.0	2.0
C3225 [CC1210]	2.2	5.0	2.9
C4532 [CC1812]	3.5	7.0	3.7
C5750 [CC2220]	4.5	8.0	5.6

1. Material : Glass Epoxy(As per JIS C6484 GE4)

2. Thickness : Appendix 1 — 0.8mm (C1005)  
 — 1.6mm (C1608,C2012,C3216,C3225,C4532,C5750)  
 : Appendix 2 — 1.6mm

Copper(Thickness:0.035mm)  
 Solder resist

## 8. INSIDE STRUCTURE AND MATERIAL

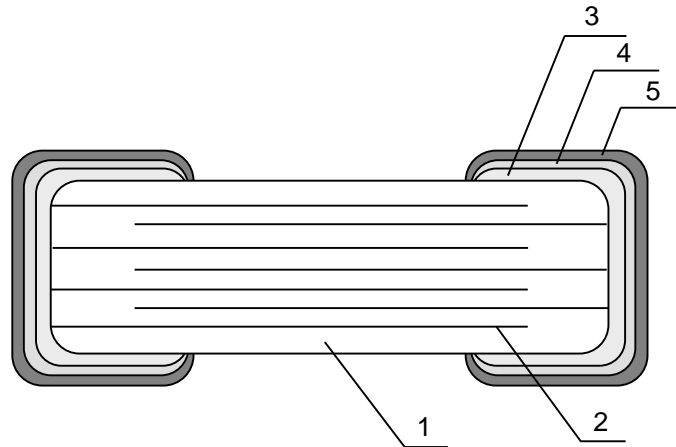

No.	NAME	MATERIAL	
		Class1	Class2
1	Dielectric	CaZrO <sub>3</sub>	BaTiO <sub>3</sub>
2	Electrode	Nickel (Ni)	
3	Termination	Copper (Cu)	
4		Nickel (Ni)	
5		Tin (Sn)	

## 9. PACKAGING

Packaging shall be done to protect the components from the damage during transportation and storing, and a label which has the following information shall be attached.

9.1 Each plastic bag for bulk packaging contains 1000pcs. And the minimum quantity for Bulk packaging is 1000pcs.

9.2 Tape packaging is as per 13. TAPE PACKAGING SPECIFICATION.

\*C1005[CC0402] type is applicable to tape packaging only.

- 1) Inspection No.\*
- 2) TDK P/N
- 3) Customer's P/N
- 4) Quantity

\*Composition of Inspection No.

Example    F 9 A - 23 - 001  
                  (a) (b) (c)    (d)    (e)

- (a) Line code
- (b) Last digit of the year
- (c) Month and A for January and B for February and so on. (Skip I)
- (d) Inspection Date of the month.
- (e) Serial No. of the day

\*Composition of new Inspection No.

(Will be implemented on and after May 1, 2019)

Example    

I	F	9	E	2	3	A	0	0	1
---	---	---	---	---	---	---	---	---	---

  
                  (a) (b) (c) (d)    (e)    (f)    (g)

- (a) Prefix
- (b) Line code
- (c) Last digit of the year
- (d) Month and A for January and B for February and so on. (Skip I)
- (e) Inspection Date of the month.
- (f) Serial No. of the day(00 ~ ZZ)
- (g) Suffix(00 ~ ZZ)

\*It is planned to shift to the new inspection No. on and after May 2019, but the implementation timing may be different depending on shipment bases.

Until the shift is completed, either current or new composition of inspection No. will be applied.

## 10. RECOMMENDATION

As for C3225[CC1210] and larger, It is recommended to provide a slit (about 1mm width) in the board under the components to improve washing Flux. And please make sure to dry detergent up completely before.

## 11. SOLDERING CONDITION

As for C1005[CC0402], C3225[CC1210] and larger, reflow soldering only.

## 12. CAUTION

No.	Process	Condition																
1	Operating Condition (Storage, Use, Transportation)	<p>1-1. Storage, Use</p> <ol style="list-style-type: none"> <li>1) The capacitors must be stored in an ambient temperature of 5 to 40°C with a relative humidity of 20 to 70%RH. The products should be used within 6 months upon receipt.</li> <li>2) The capacitors must be operated and stored in an environment free of dew condensation and these gases such as Hydrogen Sulphide, Hydrogen Sulphate, Chlorine, Ammonia and sulfur.</li> <li>3) Avoid storing in sun light and falling of dew.</li> <li>4) Do not use capacitors under high humidity and high and low atmospheric pressure which may affect capacitors reliability.</li> <li>5) Capacitors should be tested for the solderability when they are stored for long time.</li> </ol> <p>1-2. Handling in transportation</p> <p>In case of the transportation of the capacitors, the performance of the capacitors may be deteriorated depending on the transportation condition.            (Refer to JEITA RCR-2335C 9.2 Handling in transportation)</p>																
2	Circuit design  Caution	<p>2-1. Operating temperature</p> <p>Operating temperature should be followed strictly within this specification, especially be careful with maximum temperature.</p> <ol style="list-style-type: none"> <li>1) Do not use capacitors above the maximum allowable operating temperature.</li> <li>2) Surface temperature including self heating should be below maximum operating temperature.            (Due to dielectric loss, capacitors will heat itself when AC is applied. Especially at high frequencies around its SRF, the heat might be so extreme that it may damage itself or the product mounted on. Please design the circuit so that the maximum temperature of the capacitors including the self heating to be below the maximum allowable operating temperature. Temperature rise at capacitor surface shall be below 20°C)</li> <li>3) The electrical characteristics of the capacitors will vary depending on the temperature. The capacitors should be selected and designed in taking the temperature into consideration.</li> </ol> <p>2-2. Operating voltage</p> <ol style="list-style-type: none"> <li>1) Operating voltage across the terminals should be below the rated voltage.            When AC and DC are super imposed, <math>V_{0-P}</math> must be below the rated voltage.            — (1) and (2)            AC or pulse with overshooting, <math>V_{P-P}</math> must be below the rated voltage.            — (3), (4) and (5)            When the voltage is started to apply to the circuit or it is stopped applying, the irregular voltage may be generated for a transit period because of resonance or switching. Be sure to use the capacitors within rated voltage containing these Irregular voltage.</li> </ol> <table border="1" data-bbox="459 1473 1444 2063"> <thead> <tr> <th data-bbox="459 1473 659 1518">Voltage</th> <th data-bbox="659 1473 922 1518">(1) DC voltage</th> <th data-bbox="922 1473 1185 1518">(2) DC+AC voltage</th> <th data-bbox="1185 1473 1444 1518">(3) AC voltage</th> </tr> </thead> <tbody> <tr> <td data-bbox="459 1518 659 1742">           Positional Measurement            (Rated voltage)         </td> <td data-bbox="659 1518 922 1742">  </td> <td data-bbox="922 1518 1185 1742">  </td> <td data-bbox="1185 1518 1444 1742">  </td> </tr> <tr> <th data-bbox="459 1771 659 1816">Voltage</th> <th data-bbox="659 1771 922 1816">(4) Pulse voltage (A)</th> <th data-bbox="922 1771 1185 1816">(5) Pulse voltage (B)</th> <th></th> </tr> <tr> <td data-bbox="459 1816 659 2063">           Positional Measurement            (Rated voltage)         </td> <td data-bbox="659 1816 922 2063">  </td> <td data-bbox="922 1816 1185 2063">  </td> <td></td> </tr> </tbody> </table>	Voltage	(1) DC voltage	(2) DC+AC voltage	(3) AC voltage	Positional Measurement (Rated voltage)				Voltage	(4) Pulse voltage (A)	(5) Pulse voltage (B)		Positional Measurement (Rated voltage)			
Voltage	(1) DC voltage	(2) DC+AC voltage	(3) AC voltage															
Positional Measurement (Rated voltage)																		
Voltage	(4) Pulse voltage (A)	(5) Pulse voltage (B)																
Positional Measurement (Rated voltage)																		

No.	Process	Condition																																																																	
2	Circuit design ⚠ Caution	<p>2) Even below the rated voltage, if repetitive high frequency AC or pulse is applied, the reliability of the capacitors may be reduced.</p> <p>3) The effective capacitance will vary depending on applied DC and AC voltages. The capacitors should be selected and designed in taking the voltages into consideration.</p> <p>2-3. Frequency When the capacitors (Class 2) are used in AC and/or pulse voltages, the capacitors may vibrate themselves and generate audible sound.</p>																																																																	
3	Designing P.C.board	<p>The amount of solder at the terminations has a direct effect on the reliability of the capacitors.</p> <p>1) The greater the amount of solder, the higher the stress on the chip capacitors, and the more likely that it will break. When designing a P.C.board, determine the shape and size of the solder lands to have proper amount of solder on the terminations.</p> <p>2) Avoid using common solder land for multiple terminations and provide individual solder land for each terminations.</p> <p>3) Size and recommended land dimensions.</p> <div data-bbox="654 851 1372 1131" style="text-align: center;"> </div> <p style="text-align: center;">Flow soldering (Unit : mm)</p> <table border="1" style="width: 100%; border-collapse: collapse;"> <thead> <tr> <th style="text-align: center;">Case size</th> <th style="text-align: center;">C1608 [CC0603]</th> <th style="text-align: center;">C2012 [CC0805]</th> <th style="text-align: center;">C3216 [CC1206]</th> </tr> </thead> <tbody> <tr> <td style="text-align: center;">Symbol</td> <td></td> <td></td> <td></td> </tr> <tr> <td style="text-align: center;">A</td> <td style="text-align: center;">0.7 ~ 1.0</td> <td style="text-align: center;">1.0 ~ 1.3</td> <td style="text-align: center;">2.1 ~ 2.5</td> </tr> <tr> <td style="text-align: center;">B</td> <td style="text-align: center;">0.8 ~ 1.0</td> <td style="text-align: center;">1.0 ~ 1.2</td> <td style="text-align: center;">1.1 ~ 1.3</td> </tr> <tr> <td style="text-align: center;">C</td> <td style="text-align: center;">0.6 ~ 0.8</td> <td style="text-align: center;">0.8 ~ 1.1</td> <td style="text-align: center;">1.0 ~ 1.3</td> </tr> </tbody> </table> <p style="text-align: center;">Reflow soldering (Unit : mm)</p> <table border="1" style="width: 100%; border-collapse: collapse;"> <thead> <tr> <th style="text-align: center;">Case size</th> <th style="text-align: center;">C1005 [CC0402]</th> <th style="text-align: center;">C1608 [CC0603]</th> <th style="text-align: center;">C2012 [CC0805]</th> <th style="text-align: center;">C3216 [CC1206]</th> </tr> </thead> <tbody> <tr> <td style="text-align: center;">Symbol</td> <td></td> <td></td> <td></td> <td></td> </tr> <tr> <td style="text-align: center;">A</td> <td style="text-align: center;">0.3 ~ 0.5</td> <td style="text-align: center;">0.6 ~ 0.8</td> <td style="text-align: center;">0.9 ~ 1.2</td> <td style="text-align: center;">2.0 ~ 2.4</td> </tr> <tr> <td style="text-align: center;">B</td> <td style="text-align: center;">0.35 ~ 0.45</td> <td style="text-align: center;">0.6 ~ 0.8</td> <td style="text-align: center;">0.7 ~ 0.9</td> <td style="text-align: center;">1.0 ~ 1.2</td> </tr> <tr> <td style="text-align: center;">C</td> <td style="text-align: center;">0.4 ~ 0.6</td> <td style="text-align: center;">0.6 ~ 0.8</td> <td style="text-align: center;">0.9 ~ 1.2</td> <td style="text-align: center;">1.1 ~ 1.6</td> </tr> </tbody> </table> <table border="1" style="width: 100%; border-collapse: collapse; margin-top: 10px;"> <thead> <tr> <th style="text-align: center;">Case size</th> <th style="text-align: center;">C3225 [CC1210]</th> <th style="text-align: center;">C4532 [CC1812]</th> <th style="text-align: center;">C5750 [CC2220]</th> </tr> </thead> <tbody> <tr> <td style="text-align: center;">Symbol</td> <td></td> <td></td> <td></td> </tr> <tr> <td style="text-align: center;">A</td> <td style="text-align: center;">2.0 ~ 2.4</td> <td style="text-align: center;">3.1 ~ 3.7</td> <td style="text-align: center;">4.1 ~ 4.8</td> </tr> <tr> <td style="text-align: center;">B</td> <td style="text-align: center;">1.0 ~ 1.2</td> <td style="text-align: center;">1.2 ~ 1.4</td> <td style="text-align: center;">1.2 ~ 1.4</td> </tr> <tr> <td style="text-align: center;">C</td> <td style="text-align: center;">1.9 ~ 2.5</td> <td style="text-align: center;">2.4 ~ 3.2</td> <td style="text-align: center;">4.0 ~ 5.0</td> </tr> </tbody> </table>	Case size	C1608 [CC0603]	C2012 [CC0805]	C3216 [CC1206]	Symbol				A	0.7 ~ 1.0	1.0 ~ 1.3	2.1 ~ 2.5	B	0.8 ~ 1.0	1.0 ~ 1.2	1.1 ~ 1.3	C	0.6 ~ 0.8	0.8 ~ 1.1	1.0 ~ 1.3	Case size	C1005 [CC0402]	C1608 [CC0603]	C2012 [CC0805]	C3216 [CC1206]	Symbol					A	0.3 ~ 0.5	0.6 ~ 0.8	0.9 ~ 1.2	2.0 ~ 2.4	B	0.35 ~ 0.45	0.6 ~ 0.8	0.7 ~ 0.9	1.0 ~ 1.2	C	0.4 ~ 0.6	0.6 ~ 0.8	0.9 ~ 1.2	1.1 ~ 1.6	Case size	C3225 [CC1210]	C4532 [CC1812]	C5750 [CC2220]	Symbol				A	2.0 ~ 2.4	3.1 ~ 3.7	4.1 ~ 4.8	B	1.0 ~ 1.2	1.2 ~ 1.4	1.2 ~ 1.4	C	1.9 ~ 2.5	2.4 ~ 3.2	4.0 ~ 5.0
Case size	C1608 [CC0603]	C2012 [CC0805]	C3216 [CC1206]																																																																
Symbol																																																																			
A	0.7 ~ 1.0	1.0 ~ 1.3	2.1 ~ 2.5																																																																
B	0.8 ~ 1.0	1.0 ~ 1.2	1.1 ~ 1.3																																																																
C	0.6 ~ 0.8	0.8 ~ 1.1	1.0 ~ 1.3																																																																
Case size	C1005 [CC0402]	C1608 [CC0603]	C2012 [CC0805]	C3216 [CC1206]																																																															
Symbol																																																																			
A	0.3 ~ 0.5	0.6 ~ 0.8	0.9 ~ 1.2	2.0 ~ 2.4																																																															
B	0.35 ~ 0.45	0.6 ~ 0.8	0.7 ~ 0.9	1.0 ~ 1.2																																																															
C	0.4 ~ 0.6	0.6 ~ 0.8	0.9 ~ 1.2	1.1 ~ 1.6																																																															
Case size	C3225 [CC1210]	C4532 [CC1812]	C5750 [CC2220]																																																																
Symbol																																																																			
A	2.0 ~ 2.4	3.1 ~ 3.7	4.1 ~ 4.8																																																																
B	1.0 ~ 1.2	1.2 ~ 1.4	1.2 ~ 1.4																																																																
C	1.9 ~ 2.5	2.4 ~ 3.2	4.0 ~ 5.0																																																																

No.	Process	Condition	
3	Designing P.C.board	4) Recommended chip capacitors layout is as following.	
		Disadvantage against bending stress	Advantage against bending stress
Mounting face	 <p data-bbox="740 427 948 456">Perforation or slit</p> <p data-bbox="501 539 616 600">Mounting face</p> <p data-bbox="687 689 938 757">Break P.C.board with mounted side up.</p>	 <p data-bbox="1123 427 1331 456">Perforation or slit</p> <p data-bbox="1082 539 1197 600">Mounting face</p> <p data-bbox="1082 689 1332 757">Break P.C.board with mounted side down.</p>	
Chip arrangement (Direction)	 <p data-bbox="740 898 948 927">Perforation or slit</p> <p data-bbox="480 958 639 1055">Chip arrangement (Direction)</p>	 <p data-bbox="1123 898 1331 927">Perforation or slit</p>	
Distance from slit	 <p data-bbox="756 1346 836 1375"><math>l_1</math></p> <p data-bbox="475 1435 639 1496">Distance from slit</p> <p data-bbox="884 1608 995 1637"><math>(l_1 &lt; l_2)</math></p>	 <p data-bbox="1219 1346 1299 1375"><math>l_2</math></p> <p data-bbox="1273 1608 1385 1637"><math>(l_1 &lt; l_2)</math></p>	
		Closer to slit is higher stress	Away from slit is less stress

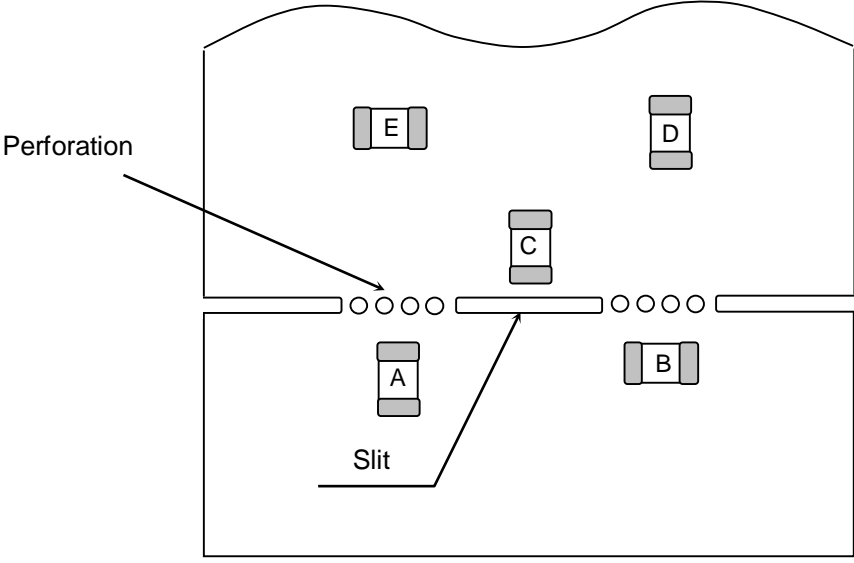
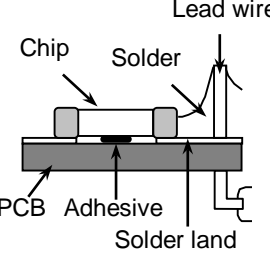
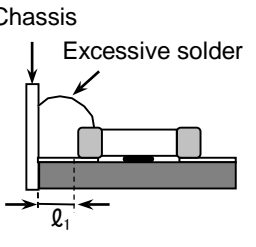
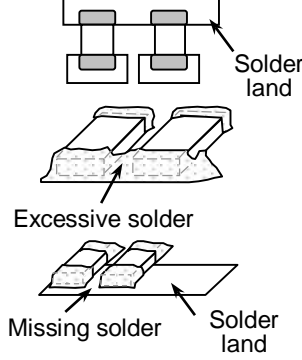
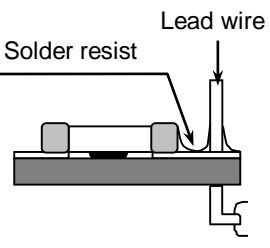
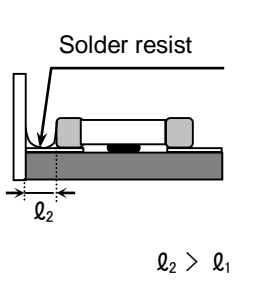
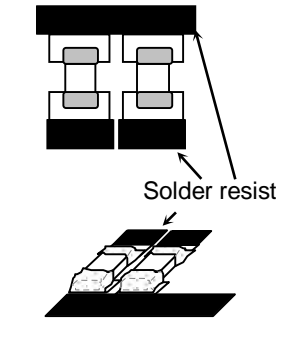
No.	Process	Condition	
3	Designing P.C.board	<p>5) Mechanical stress varies according to location of chip capacitors on the P.C.board.</p>  <p>The stress in capacitors is in the following order.  <math>A &gt; B = C &gt; D &gt; E</math></p>	
6) Layout recommendation			
Example	Use of common solder land	Soldering with chassis	Use of common solder land with other SMD
Need to avoid			
Recommendation		 <p><math>l_2 &gt; l_1</math></p>	

No.	Process	Condition																	
4	Mounting	<p>4-1. Stress from mounting head</p> <p>If the mounting head is adjusted too low, it may induce excessive stress in the chip capacitors to result in cracking. Please take following precautions.</p> <ol style="list-style-type: none"> <li>1) Adjust the bottom dead center of the mounting head to reach on the P.C.board surface and not press it.</li> <li>2) Adjust the mounting head pressure to be 1 to 3N of static weight.</li> <li>3) To minimize the impact energy from mounting head, it is important to provide support from the bottom side of the P.C.board. See following examples.</li> </ol> <table border="1" style="width: 100%; border-collapse: collapse;"> <thead> <tr> <th style="width: 30%;"></th> <th style="width: 35%;">Not recommended</th> <th style="width: 35%;">Recommended</th> </tr> </thead> <tbody> <tr> <td style="text-align: center; vertical-align: middle;">Single-sided mounting</td> <td style="text-align: center;">  </td> <td style="text-align: center;">  </td> </tr> <tr> <td style="text-align: center; vertical-align: middle;">Double-sides mounting</td> <td style="text-align: center;">  </td> <td style="text-align: center;">  </td> </tr> </tbody> </table> <p>When the centering jaw is worn out, it may give mechanical impact on the capacitors to cause crack. Please control the close up dimension of the centering jaw and provide sufficient preventive maintenance and replacement of it.</p> <p>4-2. Amount of adhesive</p> <div style="text-align: center;">  </div> <table border="1" style="width: 100%; border-collapse: collapse; margin-top: 10px;"> <tr> <td colspan="2" style="text-align: center;">Example : C2012 [CC0805], C3216 [CC1206]</td> </tr> <tr> <td style="width: 15%; text-align: center;">a</td> <td style="text-align: center;">0.2mm min.</td> </tr> <tr> <td style="text-align: center;">b</td> <td style="text-align: center;">70 ~ 100μm</td> </tr> <tr> <td style="text-align: center;">c</td> <td style="text-align: center;">Do not touch the solder land</td> </tr> </table>		Not recommended	Recommended	Single-sided mounting			Double-sides mounting			Example : C2012 [CC0805], C3216 [CC1206]		a	0.2mm min.	b	70 ~ 100μm	c	Do not touch the solder land
	Not recommended	Recommended																	
Single-sided mounting																			
Double-sides mounting																			
Example : C2012 [CC0805], C3216 [CC1206]																			
a	0.2mm min.																		
b	70 ~ 100μm																		
c	Do not touch the solder land																		

No.	Process	Condition																								
5	Soldering	<p>5-1. Flux selection                      Flux can seriously affect the performance of capacitors. Confirm the following to select the appropriate flux.</p> <ol style="list-style-type: none"> <li>1) It is recommended to use a mildly activated rosin flux (less than 0.1wt% chlorine). Strong flux is not recommended.</li> <li>2) Excessive flux must be avoided. Please provide proper amount of flux.</li> <li>3) When water-soluble flux is used, enough washing is necessary.</li> </ol> <p>5-2. Recommended soldering profile by various methods</p> <div style="display: flex; justify-content: space-around;"> <div style="text-align: center;"> <p><b>Wave soldering</b></p> </div> <div style="text-align: center;"> <p><b>Reflow soldering</b></p> </div> </div> <div style="text-align: center; margin-top: 20px;"> <p><b>Manual soldering (Solder iron)</b></p> </div> <div style="margin-top: 20px;"> <p><b>APPLICATION</b>                      As for C1608 [CC0603], C2012 [CC0805] and C3216 [CC1206], applied to wave soldering and reflow soldering.                      As for other case sizes, applied only to reflow soldering.</p> </div> <p>*As for peak temperature of manual soldering, please refer "5-6. Solder repair by solder iron" .</p> <p>5-3. Recommended soldering peak temp and peak temp duration</p> <table border="1" style="width: 100%; border-collapse: collapse; text-align: center;"> <thead> <tr> <th rowspan="2" style="text-align: left;">Temp./Duration</th> <th colspan="2">Wave soldering</th> <th colspan="2">Reflow soldering</th> </tr> <tr> <th>Peak temp(°C)</th> <th>Duration(sec.)</th> <th>Peak temp(°C)</th> <th>Duration(sec.)</th> </tr> </thead> <tbody> <tr> <td style="text-align: left;">Solder</td> <td></td> <td></td> <td></td> <td></td> </tr> <tr> <td style="text-align: left;">Sn-Pb Solder</td> <td>250 max.</td> <td>3 max.</td> <td>230 max.</td> <td>20 max.</td> </tr> <tr> <td style="text-align: left;">Lead Free Solder</td> <td>260 max.</td> <td>5 max.</td> <td>260 max.</td> <td>10 max.</td> </tr> </tbody> </table> <p>Recommended solder compositions                      Lead Free Solder : Sn-3.0Ag-0.5Cu                      Sn-Pb Solder : Sn-37Pb</p>	Temp./Duration	Wave soldering		Reflow soldering		Peak temp(°C)	Duration(sec.)	Peak temp(°C)	Duration(sec.)	Solder					Sn-Pb Solder	250 max.	3 max.	230 max.	20 max.	Lead Free Solder	260 max.	5 max.	260 max.	10 max.
Temp./Duration	Wave soldering			Reflow soldering																						
	Peak temp(°C)	Duration(sec.)	Peak temp(°C)	Duration(sec.)																						
Solder																										
Sn-Pb Solder	250 max.	3 max.	230 max.	20 max.																						
Lead Free Solder	260 max.	5 max.	260 max.	10 max.																						

No.	Process	Condition																																					
5	Soldering	<p>5-4. Avoiding thermal shock</p> <p>1) Preheating condition</p> <table border="1"> <thead> <tr> <th>Soldering</th> <th>Case size</th> <th>Temp. (°C)</th> </tr> </thead> <tbody> <tr> <td>Wave soldering</td> <td>C1608[CC0603], C2012[CC0805], C3216[CC1206]</td> <td><math>\Delta T \leq 150</math></td> </tr> <tr> <td rowspan="2">Reflow soldering</td> <td>C1005[CC0402], C1608[CC0603], C2012[CC0805], C3216[CC1206]</td> <td><math>\Delta T \leq 150</math></td> </tr> <tr> <td>C3225[CC1210], C4532[CC1812], C5750[CC2220]</td> <td><math>\Delta T \leq 130</math></td> </tr> <tr> <td rowspan="2">Manual soldering</td> <td>C1005[CC0402], C1608[CC0603], C2012[CC0805], C3216[CC1206]</td> <td><math>\Delta T \leq 150</math></td> </tr> <tr> <td>C3225[CC1210], C4532[CC1812], C5750[CC2220]</td> <td><math>\Delta T \leq 130</math></td> </tr> </tbody> </table> <p>2) Cooling condition Natural cooling using air is recommended. If the chips are dipped into a solvent for cleaning, the temperature difference (<math>\Delta T</math>) must be less than 100°C.</p> <p>5-5. Amount of solder Excessive solder will induce higher tensile force in chip capacitors when temperature changes and it may result in chip cracking. In sufficient solder may detach the capacitors from the P.C.board.</p> <table border="1"> <tbody> <tr> <td>Excessive solder</td> <td></td> <td>Higher tensile force in chip capacitors to cause crack</td> </tr> <tr> <td>Adequate</td> <td></td> <td></td> </tr> <tr> <td>Insufficient solder</td> <td></td> <td>Low robustness may cause contact failure or chip capacitors come off the P.C.board.</td> </tr> </tbody> </table> <p>5-6. Solder repair by solder iron</p> <p>1) Selection of the soldering iron tip Tip temperature of solder iron varies by its type, P.C.board material and solder land size. The higher the tip temperature, the quicker the operation. However, heat shock may cause a crack in the chip capacitors. Please make sure the tip temp. before soldering and keep the peak temp and time in accordance with following recommended condition.</p> <p>Recommended solder iron condition (Sn-Pb Solder and Lead Free Solder)</p> <table border="1"> <thead> <tr> <th>Case size</th> <th>Temp. (°C)</th> <th>Duration (sec.)</th> <th>Wattage (W)</th> <th>Shape (mm)</th> </tr> </thead> <tbody> <tr> <td>C1005[CC0402] C1608[CC0603] C2012[CC0805] C3216[CC1206]</td> <td>350 max.</td> <td rowspan="2">3 max.</td> <td rowspan="2">20 max.</td> <td rowspan="2">∅ 3.0 max.</td> </tr> <tr> <td>C3225[CC1210] C4532[CC1812] C5750[CC2220]</td> <td>280 max.</td> </tr> </tbody> </table> <p>* Please preheat the chip capacitors with the condition in 5-4 to avoid the thermal shock.</p> <p>2) Direct contact of the soldering iron with ceramic dielectric of chip capacitors may cause crack. Do not touch the ceramic dielectric and the terminations by solder iron.</p>	Soldering	Case size	Temp. (°C)	Wave soldering	C1608[CC0603], C2012[CC0805], C3216[CC1206]	$\Delta T \leq 150$	Reflow soldering	C1005[CC0402], C1608[CC0603], C2012[CC0805], C3216[CC1206]	$\Delta T \leq 150$	C3225[CC1210], C4532[CC1812], C5750[CC2220]	$\Delta T \leq 130$	Manual soldering	C1005[CC0402], C1608[CC0603], C2012[CC0805], C3216[CC1206]	$\Delta T \leq 150$	C3225[CC1210], C4532[CC1812], C5750[CC2220]	$\Delta T \leq 130$	Excessive solder		Higher tensile force in chip capacitors to cause crack	Adequate			Insufficient solder		Low robustness may cause contact failure or chip capacitors come off the P.C.board.	Case size	Temp. (°C)	Duration (sec.)	Wattage (W)	Shape (mm)	C1005[CC0402] C1608[CC0603] C2012[CC0805] C3216[CC1206]	350 max.	3 max.	20 max.	∅ 3.0 max.	C3225[CC1210] C4532[CC1812] C5750[CC2220]	280 max.
Soldering	Case size	Temp. (°C)																																					
Wave soldering	C1608[CC0603], C2012[CC0805], C3216[CC1206]	$\Delta T \leq 150$																																					
Reflow soldering	C1005[CC0402], C1608[CC0603], C2012[CC0805], C3216[CC1206]	$\Delta T \leq 150$																																					
	C3225[CC1210], C4532[CC1812], C5750[CC2220]	$\Delta T \leq 130$																																					
Manual soldering	C1005[CC0402], C1608[CC0603], C2012[CC0805], C3216[CC1206]	$\Delta T \leq 150$																																					
	C3225[CC1210], C4532[CC1812], C5750[CC2220]	$\Delta T \leq 130$																																					
Excessive solder		Higher tensile force in chip capacitors to cause crack																																					
Adequate																																							
Insufficient solder		Low robustness may cause contact failure or chip capacitors come off the P.C.board.																																					
Case size	Temp. (°C)	Duration (sec.)	Wattage (W)	Shape (mm)																																			
C1005[CC0402] C1608[CC0603] C2012[CC0805] C3216[CC1206]	350 max.	3 max.	20 max.	∅ 3.0 max.																																			
C3225[CC1210] C4532[CC1812] C5750[CC2220]	280 max.																																						

No.	Process	Condition												
5	Soldering	<p>5-7.Soldering rework using spot heater Heat stress during rework may possibly be reduced by using a spot heater (also called a “blower”) rather than a soldering iron. It is applied only to adding solder in the case of insufficient solder amount.</p> <p>1) Reworking using a spot heater may suppress the occurrence of cracks in the capacitor compared to using a soldering iron. A spot heater can heat up a capacitor uniformly with a small heat gradient which leads to lower thermal stress caused by quick heating and cooling or localized heating. Moreover, where ultra-small capacitors are mounted close together on a printed circuit board, reworking with a spot heater can eliminate the risk of direct contact between the tip of a soldering iron and a capacitor.</p> <p>2) Rework condition If the blower nozzle of a spot heater is too close to a capacitor, a crack in the capacitor may occur due to heat stress. Below are recommendations for avoiding such an occurrence. Keep more than 5mm between a capacitor and a spot heater nozzle. The blower temperature of the spot heater shall be lower than 400°C. The airflow shall be set as weak as possible. The diameter of the nozzle is recommended to be 2mm(one-outlet type).The size is standard and common. Duration of blowing hot air is recommended to be 10s or less for C1608 [CC0603], C2012 [CC0805] and C3216 [CC1206], and 30s or less for C3225 [CC1210], C4532 [CC1812] and C5750 [CC2220], considering surface area of the capacitor and melting temperature of solder. The angle between the nozzle and the capacitor is recommended to be 45degrees in order to work easily and to avoid partial area heating. As is the case when using a soldering iron, preheating reduces thermal stress on capacitors and improves operating efficiency.</p> <p>• Recommended rework condition (Consult the component manufactures for details.)</p> <table border="1" data-bbox="512 1133 1453 1480"> <tbody> <tr> <td>Distance from nozzle</td> <td>5mm and over</td> </tr> <tr> <td>Nozzle angle</td> <td>45degrees</td> </tr> <tr> <td>Nozzle temp.</td> <td>400°C and less</td> </tr> <tr> <td>Airflow</td> <td>Set as weak as possible (The airflow shall be the minimum value necessary for solder to melt in the conditions mentioned above.)</td> </tr> <tr> <td>Nozzle diameter</td> <td>∅ 2mm (one-outlet type)</td> </tr> <tr> <td>Blowing duration</td> <td>10s and less (C1608[CC0603], C2012[CC0805], C3216[CC1206]) 30s and less (C3225[CC1210], C4532[CC1812], C5750[CC2220])</td> </tr> </tbody> </table> <p>• Example of recommended spot heater use</p>  <p>3) Amount of solder should be suitable to form a proper fillet shape. Excess solder causes mechanical and thermal stress on a capacitor and results in cracks. Insufficient solder causes weak adherence of the capacitor to the substrate and may result in detachment of a capacitor and deteriorate reliability of the printed wiring board. See the example of appropriate solder fillet shape for 5-5.Amount of solder.</p>	Distance from nozzle	5mm and over	Nozzle angle	45degrees	Nozzle temp.	400°C and less	Airflow	Set as weak as possible (The airflow shall be the minimum value necessary for solder to melt in the conditions mentioned above.)	Nozzle diameter	∅ 2mm (one-outlet type)	Blowing duration	10s and less (C1608[CC0603], C2012[CC0805], C3216[CC1206]) 30s and less (C3225[CC1210], C4532[CC1812], C5750[CC2220])
Distance from nozzle	5mm and over													
Nozzle angle	45degrees													
Nozzle temp.	400°C and less													
Airflow	Set as weak as possible (The airflow shall be the minimum value necessary for solder to melt in the conditions mentioned above.)													
Nozzle diameter	∅ 2mm (one-outlet type)													
Blowing duration	10s and less (C1608[CC0603], C2012[CC0805], C3216[CC1206]) 30s and less (C3225[CC1210], C4532[CC1812], C5750[CC2220])													

No.	Process	Condition
5	Soldering	<p>5-8. Sn-Zn solder Sn-Zn solder affects product reliability. Please contact TDK in advance when utilize Sn-Zn solder.</p> <p>5-9. Countermeasure for tombstone The misalignment between the mounted positions of the capacitors and the land patterns should be minimized. The tombstone phenomenon may occur especially the capacitors are mounted (in longitudinal direction) in the same direction of the reflow soldering. (Refer to JEITA RCR-2335C Annex A (Informative) Recommendations to prevent the tombstone phenomenon)</p>
6	Cleaning	<p>1) If an unsuitable cleaning fluid is used, flux residue or some foreign articles may stick to chip capacitors surface to deteriorate especially the insulation resistance.</p> <p>2) If cleaning condition is not suitable, it may damage the chip capacitors.</p> <p>2)-1. Insufficient washing</p> <p>(1) Terminal electrodes may corrode by Halogen in the flux.</p> <p>(2) Halogen in the flux may adhere on the surface of capacitors, and lower the insulation resistance.</p> <p>(3) Water soluble flux has higher tendency to have above mentioned problems (1) and (2).</p> <p>2)-2. Excessive washing</p> <p>When ultrasonic cleaning is used, excessively high ultrasonic energy output can affect the connection between the ceramic chip capacitor's body and the terminal electrode. To avoid this, following is the recommended condition.</p> <p style="text-align: center;">Power : 20 W/l max. Frequency : 40 kHz max. Washing time : 5 minutes max.</p> <p>2)-3. If the cleaning fluid is contaminated, density of Halogen increases, and it may bring the same result as insufficient cleaning.</p>
7	Coating and molding of the P.C.board	<p>1) When the P.C.board is coated, please verify the quality influence on the product.</p> <p>2) Please verify carefully that there is no harmful decomposing or reaction gas emission during curing which may damage the chip capacitors.</p> <p>3) Please verify the curing temperature.</p>

No.	Process	Condition				
8	Handling after chip mounted  Caution	<p>1) Please pay attention not to bend or distort the P.C.board after soldering in handling otherwise the chip capacitors may crack.</p> <div style="display: flex; justify-content: space-around;"> <div style="text-align: center;"> <p>Bend</p>  </div> <div style="text-align: center;"> <p>Twist</p>  </div> </div> <p>2) Printed circuit board cropping should not be carried out by hand, but by using the proper tooling. Printed circuit board cropping should be carried out using a board cropping jig as shown in the following figure or a board cropping apparatus to prevent inducing mechanical stress on the board.</p> <p>(1) Example of a board cropping jig</p> <p>Recommended example: The board should be pushed from the back side, close to the cropping jig so that the board is not bent and the stress applied to the capacitor is compressive.</p> <p>Unrecommended example: If the pushing direction is from the front side of the board, large tensile stress is applied to the capacitor, which may cause cracks.</p> <div style="display: flex; justify-content: space-around; align-items: flex-start;"> <div style="text-align: center;"> <p>Outline of jig</p>  </div> <table border="1" style="width: 100%; border-collapse: collapse;"> <thead> <tr> <th style="width: 50%; text-align: center;">Recommended</th> <th style="width: 50%; text-align: center;">Unrecommended</th> </tr> </thead> <tbody> <tr> <td style="text-align: center;">  </td> <td style="text-align: center;">  </td> </tr> </tbody> </table> </div>	Recommended	Unrecommended		
Recommended	Unrecommended					
						

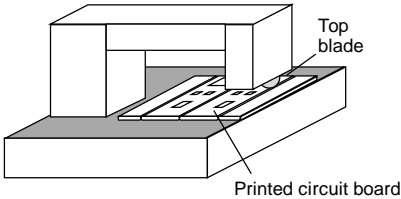
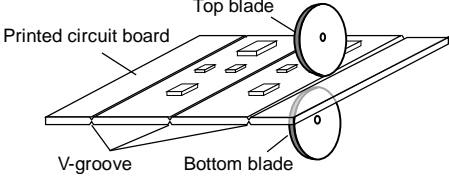
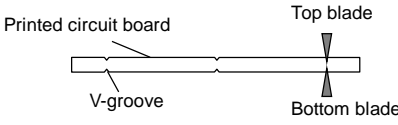
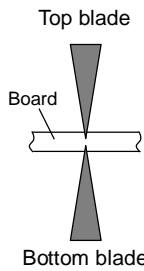
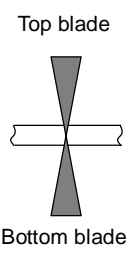
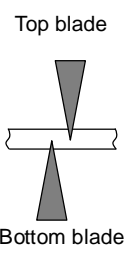
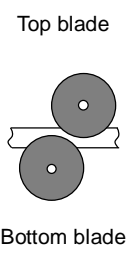
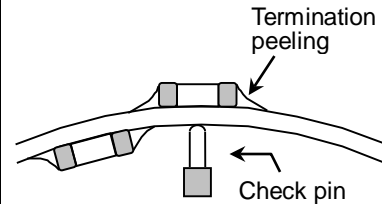
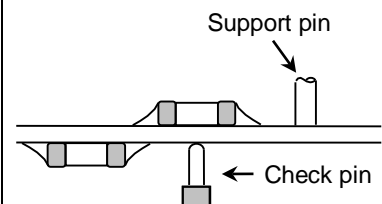
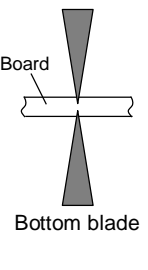
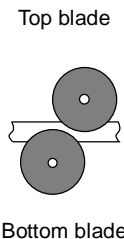
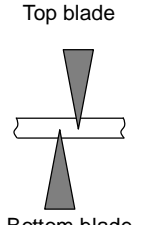
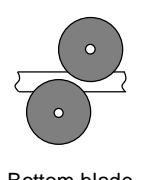
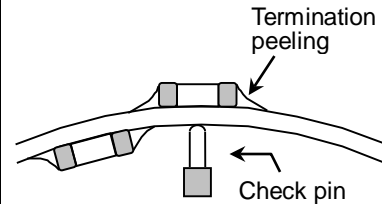
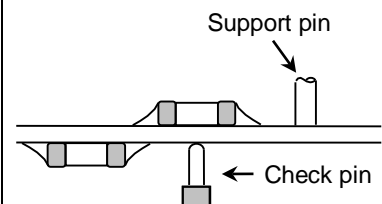
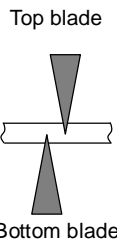
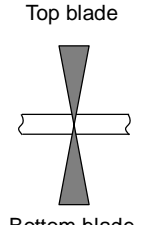
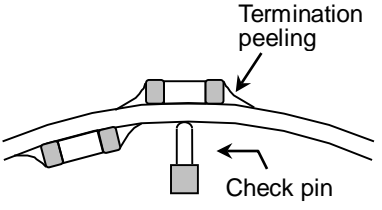
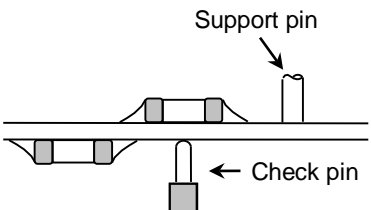
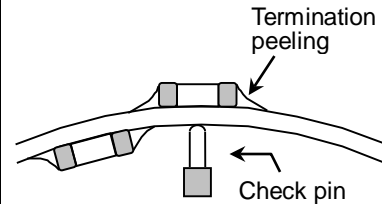
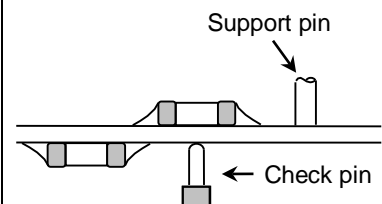
No.	Process	Condition																	
8	Handling after chip mounted  Caution	<p>(2) Example of a board cropping machine</p> <p>An outline of a printed circuit board cropping machine is shown below. The top and bottom blades are aligned with one another along the lines with the V-grooves on printed circuit board when cropping the board.</p> <p>Unrecommended example: Misalignment of blade position between top and bottom, right and left, or front and rear blades may cause a crack in the capacitor.</p> <div style="display: flex; justify-content: space-around;"> <div data-bbox="564 504 967 768"> <p>Outline of machine</p>  </div> <div data-bbox="967 504 1417 745"> <p>Principle of operation</p>  </div> </div> <div style="text-align: center; margin-top: 10px;"> <p>Cross-section diagram</p>  </div> <table border="1" style="width: 100%; margin-top: 10px; border-collapse: collapse;"> <thead> <tr> <th data-bbox="646 981 826 1070" rowspan="2">Recommended</th> <th colspan="3" data-bbox="826 981 1358 1025">Unrecommended</th> </tr> <tr> <th data-bbox="826 1025 1002 1115">Top-bottom misalignment</th> <th data-bbox="1002 1025 1171 1115">Left-right misalignment</th> <th data-bbox="1171 1025 1358 1115">Front-rear misalignment</th> </tr> </thead> <tbody> <tr> <td data-bbox="646 1115 826 1411"> <p>Top blade</p>  <p>Board</p> <p>Bottom blade</p> </td> <td data-bbox="826 1115 1002 1411"> <p>Top blade</p>  <p>Bottom blade</p> </td> <td data-bbox="1002 1115 1171 1411"> <p>Top blade</p>  <p>Bottom blade</p> </td> <td data-bbox="1171 1115 1358 1411"> <p>Top blade</p>  <p>Bottom blade</p> </td> </tr> </tbody> </table> <p>3) When functional check of the P.C.board is performed, check pin pressure tends to be adjusted higher for fear of loose contact. But if the pressure is excessive and bend the P.C.board, it may crack the chip capacitors or peel the terminations off. Please adjust the check pins not to bend the P.C.board.</p> <table border="1" style="width: 100%; margin-top: 10px; border-collapse: collapse;"> <thead> <tr> <th data-bbox="478 1653 619 1720">Item</th> <th data-bbox="619 1653 1034 1720">Not recommended</th> <th data-bbox="1034 1653 1437 1720">Recommended</th> </tr> </thead> <tbody> <tr> <td data-bbox="478 1720 619 1951">Board bending</td> <td data-bbox="619 1720 1034 1951">  <p>Termination peeling</p> <p>Check pin</p> </td> <td data-bbox="1034 1720 1437 1951">  <p>Support pin</p> <p>Check pin</p> </td> </tr> </tbody> </table>	Recommended	Unrecommended			Top-bottom misalignment	Left-right misalignment	Front-rear misalignment	<p>Top blade</p>  <p>Board</p> <p>Bottom blade</p>	<p>Top blade</p>  <p>Bottom blade</p>	<p>Top blade</p>  <p>Bottom blade</p>	<p>Top blade</p>  <p>Bottom blade</p>	Item	Not recommended	Recommended	Board bending	 <p>Termination peeling</p> <p>Check pin</p>	 <p>Support pin</p> <p>Check pin</p>
Recommended	Unrecommended																		
	Top-bottom misalignment	Left-right misalignment	Front-rear misalignment																
<p>Top blade</p>  <p>Board</p> <p>Bottom blade</p>	<p>Top blade</p>  <p>Bottom blade</p>	<p>Top blade</p>  <p>Bottom blade</p>	<p>Top blade</p>  <p>Bottom blade</p>																
Item	Not recommended	Recommended																	
Board bending	 <p>Termination peeling</p> <p>Check pin</p>	 <p>Support pin</p> <p>Check pin</p>																	

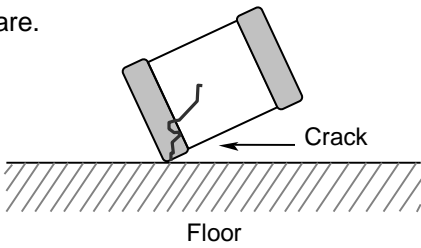
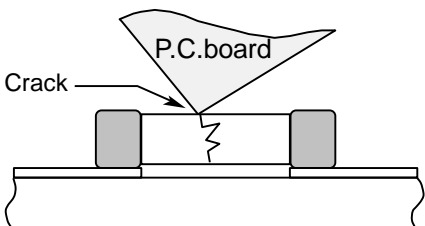
No.	Process	Condition
9	Handling of loose chip capacitors	<p>1) If dropped the chip capacitors may crack. Once dropped do not use it. Especially, the large case sized chip capacitors are tendency to have cracks easily, so please handle with care.</p>  <p>2) Piling the P.C.board after mounting for storage or handling, the corner of the P.C. board may hit the chip capacitors of another board to cause crack.</p> 
10	Capacitance aging	<p>The capacitors (Class 2) have aging in the capacitance. They may not be used in precision time constant circuit. In case of the time constant circuit, the evaluation should be done well.</p>
11	Estimated life and estimated failure rate of capacitors	<p>As per the estimated life and the estimated failure rate depend on the temperature and the voltage. This can be calculated by the equation described in JEITA RCR-2335C Annex F (Informative) Calculation of the estimated lifetime and the estimated failure rate ( Voltage acceleration coefficient : 3 multiplication rule, Temperature acceleration coefficient : 10°C rule)                      The failure rate can be decreased by reducing the temperature and the voltage but they will not be guaranteed.</p>

No.	Process	Condition
12	Caution during operation of equipment	<p>1) A capacitor shall not be touched directly with bare hands during operation in order to avoid electric shock. Electric energy held by the capacitor may be discharged through the human body when touched with a bare hand. Even when the equipment is off, a capacitor may stay charged. The capacitor should be handled after being completely discharged using a resistor.</p> <p>2) The terminals of a capacitor shall not be short-circuited by any accidental contact with a conductive object. A capacitor shall not be exposed to a conductive liquid such as an acid or alkali solution. A conductive object or liquid, such as acid and alkali, between the terminals may lead to the breakdown of a capacitor due to short circuit.</p> <p>3) Confirm that the environment to which the equipment will be exposed during transportation and operation meets the specified conditions. Do not to use the equipment in the following environments.</p> <p>(1) Environment where a capacitor is splattered with water or oil  (2) Environment where a capacitor is exposed to direct sunlight  (3) Environment where a capacitor is exposed to Ozone, ultraviolet rays or radiation  (4) Environment where a capacitor exposed to corrosive gas(e.g. hydrogen sulfide, sulfur dioxide, chlorine. ammonia gas etc.)  (5) Environment where a capacitor exposed to vibration or mechanical shock exceeding the specified limits.  (6) Atmosphere change with causes condensation</p>
13	Others  Caution	<p>The products listed on this specification sheet are intended for use in general electronic equipment (AV equipment, telecommunications equipment, home appliances, amusement equipment, computer equipment, personal equipment, office equipment, measurement equipment, industrial robots) under a normal operation and use condition.</p> <p>The products are not designed or warranted to meet the requirements of the applications listed below, whose performance and/or quality require a more stringent level of safety or reliability, or whose failure, malfunction or trouble could cause serious damage to society, person or property. Please understand that we are not responsible for any damage or liability caused by use of the products in any of the applications below or for any other use exceeding the range or conditions set forth in this specification sheet. If you intend to use the products in the applications listed below or if you have special requirements exceeding the range or conditions set forth in this specification, please contact us.</p> <p>(1) Aerospace/Aviation equipment  (2) Transportation equipment (cars, electric trains, ships, etc.)  (3) Medical equipment (Excepting Pharmaceutical Affairs Law classification Class1, 2)  (4) Power-generation control equipment  (5) Atomic energy-related equipment  (6) Seabed equipment  (7) Transportation control equipment  (8) Public information-processing equipment  (9) Military equipment  (10) Electric heating apparatus, burning equipment  (11) Disaster prevention/crime prevention equipment  (12) Safety equipment  (13) Other applications that are not considered general-purpose applications</p> <p>When designing your equipment even for general-purpose applications, you are kindly requested to take into consideration securing protection circuit/device or providing backup circuits in your equipment.</p>

## 13. TAPE PACKAGING SPECIFICATION

### 1. CONSTRUCTION AND DIMENSION OF TAPING

#### 1-1. Dimensions of carrier tape

Dimensions of paper tape shall be according to Appendix 3, 4.

Dimensions of plastic tape shall be according to Appendix 5, 6.

#### 1-2. Bulk part and leader of taping



#### 1-3. Dimensions of reel

Dimensions of  $\varnothing 178$  reel shall be according to Appendix 7, 8.

Dimensions of  $\varnothing 330$  reel shall be according to Appendix 9, 10.

#### 1-4. Structure of taping



### 2. CHIP QUANTITY

Please refer to detail page on TDK Web.

### 3. PERFORMANCE SPECIFICATIONS

#### 3-1. Fixing peeling strength (top tape)

$$0.05\text{N} < \text{Peeling strength} < 0.7\text{N}$$

<Paper>



〔 Paper tape should not adhere to top cover tape when pull the cover tape. 〕

<Plastic>



3-2. Carrier tape shall be flexible enough to be wound around a minimum radius of 30mm with components in tape.

3-3. The missing of components shall be less than 0.1%

3-4. Components shall not stick to fixing tape.

3-5. When removing the cover tape, there shall not be difficulties by unfitting clearance gap, burrs and crushes of cavities. Also the sprocket holes shall not be covered by absorbing dust into the suction nozzle.

### Appendix 3

#### Paper Tape



(Unit : mm)

Symbol	A	B	C	D	E	F
Case size						
C1005 [CC0402]	( 0.65 ) * ( 0.73 )	( 1.15 ) * ( 1.23 )	8.00 ± 0.30	3.50 ± 0.05	1.75 ± 0.10	2.00 ± 0.05

Symbol	G	H	J	T
Case size				
C1005 [CC0402]	2.00 ± 0.05	4.00 ± 0.10	∅ 1.50 <sup>+0.10</sup> <sub>0</sub>	0.60±0.05 * 0.68±0.05

( ) Reference value.

\* Applied to thickness, 0.50±0.10mm and 0.50 +0.15,-0.10mm products.

### Appendix 4

#### Paper Tape



(Unit : mm)

Symbol	A	B	C	D	E	F
Case size						
C1608 [CC0603]	( 1.10 )	( 1.90 )	8.00 ± 0.30	3.50 ± 0.05	1.75 ± 0.10	4.00 ± 0.10
C2012 [CC0805]	( 1.50 )	( 2.30 )				
C3216 [CC1206]	( 1.90 )	( 3.50 )				

Symbol	G	H	J	T
Case size				
C1608 [CC0603]	2.00 ± 0.05	4.00 ± 0.10	∅ 1.50 <sup>+0.10</sup> <sub>0</sub>	1.20 max.
C2012 [CC0805]				
C3216 [CC1206]				

( ) Reference value.

## Appendix 5

### Plastic Tape

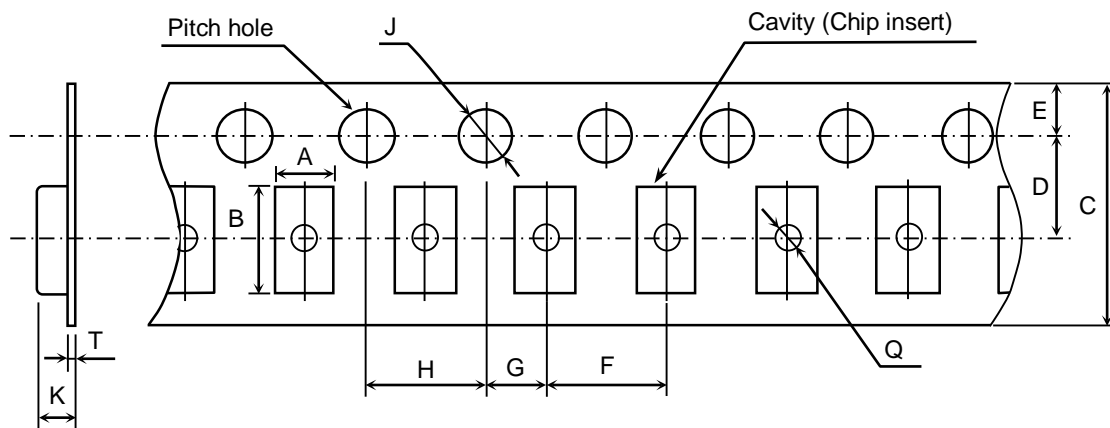

(Unit : mm)

Symbol	A	B	C	D	E	F
Case size						
C2012 [CC0805]	( 1.50 )	( 2.30 )	8.0 ± 0.3	3.5 ± 0.05	1.75 ± 0.10	4.00 ± 0.10
C3216 [CC1206]	( 1.90 )	( 3.50 )				
C3225 [CC1210]	( 2.90 )	( 3.60 )				
			*12.0 ± 0.3	*5.5 ± 0.05		

Symbol	G	H	J	K	T	Q
Case size						
C2012 [CC0805]	2.00 ± 0.05	4.00 ± 0.10	∅ 1.50 <sup>+0.10</sup> <sub>0</sub>	2.50 max.	0.60 max.	∅ 0.50 min.
C3216 [CC1206]						
C3225 [CC1210]				3.40 max.		

( ) Reference value.

\* Applied to thickness, 2.5mm products.

Exceptionally no hole in the cavity is applied. Please inquire if hole in cavity is mandatory.

### Appendix 6

#### Plastic Tape



(Unit : mm)

Symbol	A	B	C	D	E	F
Case size						
C4532 [CC1812]	( 3.60 )	( 4.90 )	12.0 ± 0.30	5.50 ± 0.05	1.75 ± 0.10	8.00 ± 0.10
C5750 [CC2220]	( 5.40 )	( 6.10 )				
Symbol	G	H	J	K	T	Q
Case size						
C4532 [CC1812]	2.00 ± 0.05	4.00 ± 0.10	∅ 1.50 <sup>+0.10</sup> <sub>0</sub>	6.50 max.	0.60 max.	∅ 1.50 min.
C5750 [CC2220]						

( ) Reference value.

Exceptionally no hole in the cavity is applied. Please inquire if hole in cavity is mandatory.

### Appendix 7

Dimensions of reel (Material : Polystyrene)  
C1005, C1608, C2012, C3216, C3225



(Unit : mm)

Symbol	A	B	C	D	E	W <sub>1</sub>
Dimension	∅ 178 ± 2.0	∅ 60 ± 2.0	∅ 13 ± 0.5	∅ 21 ± 0.8	2.0 ± 0.5	9.0 ± 0.3
Symbol	W <sub>2</sub>	R				
Dimension	13.0 ± 1.4	1.0				

### Appendix 8

Dimensions of reel (Material : Polystyrene)  
C3225(2.5mm thickness products), C4532, C5750



(Unit : mm)

Symbol	A	B	C	D	E	W <sub>1</sub>
Dimension	∅ 178 ± 2.0	∅ 60 ± 2.0	∅ 13 ± 0.5	∅ 21 ± 0.8	2.0 ± 0.5	13.0 ± 0.3
Symbol	W <sub>2</sub>	R				
Dimension	17.0 ± 1.4	1.0				

### Appendix 9

Dimensions of reel (Material : Polystyrene)  
C1005, C1608, C2012, C3216, C3225



(Unit : mm)

Symbol	A	B	C	D	E	W
Dimension	∅ 382 max. (Nominal ∅ 330)	∅ 50 min.	∅ 13 ± 0.5	∅ 21 ± 0.8	2.0 ± 0.5	10.0 ± 1.5
Symbol	t	R				
Dimension	2.0 ± 0.5	1.0				

### Appendix 10

Dimensions of reel (Material : Polystyrene)  
C3225(2.5mm thickness products), C4532, C5750



(Unit : mm)

Symbol	A	B	C	D	E	W
Dimension	∅ 382 max. (Nominal ∅ 330)	∅ 50 min.	∅ 13 ± 0.5	∅ 21 ± 0.8	2.0 ± 0.5	14.0 ± 1.5
Symbol	t	R				
Dimension	2.0 ± 0.5	1.0				

## Looking for pricing, stock, or lifecycle information?

Click below to explore more details on WIN SOURCE:

- ⊖ [View C2012C0G2E152J085AA](#) on WIN SOURCE
- ⊖ [TDK Corporation](#) Information

## Optimize Your Supply Chain with WIN SOURCE Solutions

- ✓ Global Sourcing Solution
- ✓ Obsolete Management
- ✓ Cost Control Management
- ✓ Shortage Management
- ✓ Alternative Solution
- ✓ Excess Inventory Management