

Smart High-Side Power Switch



Features

- Overload protection
- Current limitation
- Short circuit protection
- Thermal shutdown
- Overvoltage protection (including load dump)
- Fast demagnetization of inductive loads
- Reverse battery protection¹⁾
- Undervoltage and overvoltage shutdown with auto-restart and hysteresis
- Open drain diagnostic output
- Open load detection in ON-state
- CMOS compatible input
- Loss of ground and loss of V_{bb} protection
- Electrostatic discharge (ESD) protection
- Green Product (RoHS compliant)
- AEC Qualified

Product Summary			
Overvoltage protection	$V_{bb(AZ)}$	43	V
Operating voltage	$V_{bb(on)}$	5.0 ... 34	V
On-state resistance	R_{ON}	60	m Ω
Load current (ISO)	$I_L(ISO)$	7.0	A
Current limitation	$I_L(SCr)$	16	A



Application

- μ C compatible power switch with diagnostic feedback for 12 V and 24 V DC grounded loads
- All types of resistive, inductive and capacitive loads
- Replaces electromechanical relays, fuses and discrete circuits

General Description

N channel vertical power FET with charge pump, ground referenced CMOS compatible input and diagnostic feedback, monolithically integrated in Smart SIPMOS[®] technology. Providing embedded protective functions.

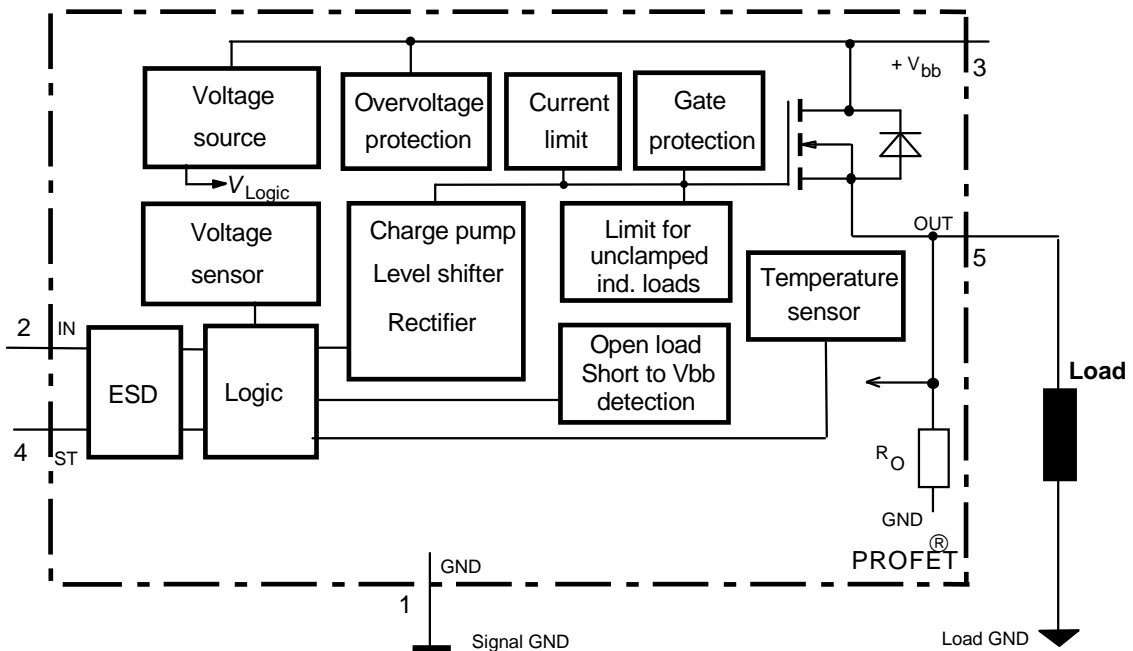

¹⁾ With external current limit (e.g. resistor $R_{GND}=150 \Omega$) in GND connection, resistor in series with ST connection, reverse load current limited by connected load.

Pin	Symbol		Function
1	GND	-	Logic ground
2	IN	I	Input, activates the power switch in case of logical high signal
3	V _{bb}	+	Positive power supply voltage, the tab is shorted to this pin
4	ST	S	Diagnostic feedback, low on failure
5	OUT (Load, L)	O	Output to the load

Maximum Ratings at $T_j = 25\text{ °C}$ unless otherwise specified			
Parameter	Symbol	Values	Unit
Supply voltage (overvoltage protection see page 3)	V_{bb}	43	V
Supply voltage for short circuit protection $T_{j\text{ start}} = -40 \dots +150\text{ °C}$	V_{bb}	34	V
Load dump protection ²⁾ $V_{\text{LoadDump}} = U_A + V_s$, $U_A = 13.5\text{ V}$ $R_1^3 = 2\ \Omega$, $R_L = 1.7\ \Omega$, $t_d = 200\text{ ms}$, IN= low or high	$V_{\text{Load dump}}^4)$	60	V
Load current (Short circuit current, see page 4)	I_L	self-limited	A
Operating temperature range	T_j	-40 ... +150	°C
Storage temperature range	T_{stg}	-55 ... +150	
Power dissipation (DC), $T_C \leq 25\text{ °C}$	P_{tot}	75	W
Inductive load switch-off energy dissipation, single pulse $V_{bb} = 12\text{ V}$, $T_{j,\text{start}} = 150\text{ °C}$, $T_C = 150\text{ °C}$ const. $I_L = 7.0\text{ A}$, $Z_L = 24\text{ mH}$, $0\ \Omega$:	E_{AS}	0.74	J
Electrostatic discharge capability (ESD) (Human Body Model) acc. MIL-STD883D, method 3015.7 and ESD assn. std. S5.1-1993	IN: V_{ESD} all other pins:	1.0 2.0	kV
Input voltage (DC)	V_{IN}	-10 ... +16	V
Current through input pin (DC)	I_{IN}	± 2.0	mA
Current through status pin (DC) see internal circuit diagrams page 6	I_{ST}	± 5.0	

Thermal Characteristics					
Parameter and Conditions	Symbol	Values			Unit
		min	typ	max	
Thermal resistance chip - case:	R_{thJC}	--	--	1.67	K/W
junction - ambient (free air):	R_{thJA}	--	--	75	
SMD version, device on PCB ⁵⁾ :				34	

²⁾ Supply voltages higher than $V_{bb(AZ)}$ require an external current limit for the GND and status pins, e.g. with a $150\ \Omega$ resistor in the GND connection and a $15\text{ k}\Omega$ resistor in series with the status pin. A resistor for the protection of the input is integrated.

³⁾ R_1 = internal resistance of the load dump test pulse generator



⁴⁾ $V_{\text{Load dump}}$ is setup without the DUT connected to the generator per ISO 7637-1 and DIN 40839

⁵⁾ Device on $50\text{ mm} \times 50\text{ mm} \times 1.5\text{ mm}$ epoxy PCB FR4 with 6 cm^2 (one layer, $70\ \mu\text{m}$ thick) copper area for V_{bb} connection. PCB is vertical without blown air.

Electrical Characteristics

Parameter and Conditions	Symbol	Values			Unit
		min	typ	max	
at $T_j = 25\text{ °C}$, $V_{bb} = 12\text{ V}$ unless otherwise specified					

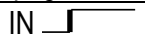
Load Switching Capabilities and Characteristics

On-state resistance (pin 3 to 5) $I_L = 2\text{ A}$	$T_j = 25\text{ °C}$: $T_j = 150\text{ °C}$:	R_{ON}	--	50 100	60 120	$m\Omega$
Nominal load current, ISO Norm (pin 3 to 5) $V_{ON} = 0.5\text{ V}$, $T_C = 85\text{ °C}$		$I_{L(ISO)}$	5.8	7.0	--	A
Output current (pin 5) while GND disconnected or GND pulled up, $V_{bb} = 30\text{ V}$, $V_{IN} = 0$, see diagram page 7		$I_{L(GNDhigh)}$	--	--	10	mA
Turn-on time IN  to 90% V_{OUT} :		t_{on}	80	200	400	μs
Turn-off time IN  to 10% V_{OUT} :		t_{off}	80	230	450	μs
$R_L = 12\ \Omega$, $T_j = -40\dots+150\text{ °C}$						
Slew rate on 10 to 30% V_{OUT} , $R_L = 12\ \Omega$, $T_j = -40\dots+150\text{ °C}$		dV/dt_{on}	0.1	--	1	$V/\mu s$
Slew rate off 70 to 40% V_{OUT} , $R_L = 12\ \Omega$, $T_j = -40\dots+150\text{ °C}$		$-dV/dt_{off}$	0.1	--	1	$V/\mu s$

Operating Parameters						
Operating voltage ⁶⁾	$T_j = -40\dots+150\text{ °C}$:	$V_{bb(on)}$	5.0	--	34	V
Undervoltage shutdown	$T_j = -40\dots+150\text{ °C}$:	$V_{bb(under)}$	3.5	--	5.0	V
Undervoltage restart	$T_j = -40\dots+25\text{ °C}$: $T_j = +150\text{ °C}$:	$V_{bb(u\ rst)}$	--	--	5.0 7.0	V
Undervoltage restart of charge pump see diagram page 12	$T_j = -40\dots+150\text{ °C}$:	$V_{bb(ucp)}$	--	5.6	7.0	V
Undervoltage hysteresis $\Delta V_{bb(under)} = V_{bb(u\ rst)} - V_{bb(under)}$		$\Delta V_{bb(under)}$	--	0.2	--	V
Overvoltage shutdown	$T_j = -40\dots+150\text{ °C}$:	$V_{bb(over)}$	34	--	43	V
Overvoltage restart	$T_j = -40\dots+150\text{ °C}$:	$V_{bb(o\ rst)}$	33	--	--	V
Overvoltage hysteresis	$T_j = -40\dots+150\text{ °C}$:	$\Delta V_{bb(over)}$	--	0.5	--	V
Overvoltage protection ⁷⁾ $I_{bb} = 40\text{ mA}$	$T_j = -40\dots+150\text{ °C}$:	$V_{bb(AZ)}$	42	47	--	V
Standby current (pin 3) $V_{IN} = 0$	$T_j = -40\dots+25\text{ °C}$: $T_j = 150\text{ °C}$:	$I_{bb(off)}$	--	10 12	25 28	μA
Leakage output current (included in $I_{bb(off)}$) $V_{IN} = 0$		$I_{L(off)}$	--	--	12	μA
Operating current (Pin 1) ⁸⁾ , $V_{IN} = 5\text{ V}$, $T_j = -40\dots+150\text{ °C}$		I_{GND}	--	1.8	3.5	mA

⁶⁾ At supply voltage increase up to $V_{bb} = 5.6\text{ V}$ typ without charge pump, $V_{OUT} \approx V_{bb} - 2\text{ V}$

⁷⁾ See also $V_{ON(CL)}$ in table of protection functions and circuit diagram page 7.



⁸⁾ Add I_{ST} , if $I_{ST} > 0$, add I_{IN} , if $V_{IN} > 5.5\text{ V}$

Parameter and Conditions	Symbol	Values			Unit
		min	typ	max	
at $T_j = 25\text{ °C}$, $V_{bb} = 12\text{ V}$ unless otherwise specified					
Protection Functions⁹⁾					
Initial peak short circuit current limit (pin 3 to 5)	$I_{L(SCp)}$				
$T_j = -40\text{ °C}$:		21	32	43	A
$T_j = 25\text{ °C}$:		15	25	35	
$T_j = +150\text{ °C}$:		11	17	24	
Repetitive short circuit shutdown current limit	$I_{L(SCr)}$				
$T_j = T_{jt}$ (see timing diagrams, page 10)		--	16	--	A
Output clamp (inductive load switch off) at $V_{OUT} = V_{bb} - V_{ON(CL)}$	$I_L = 40\text{ mA}$: $V_{ON(CL)}$	41	47	53	V
Thermal overload trip temperature	T_{jt}	150	--	--	°C
Thermal hysteresis	ΔT_{jt}	--	10	--	K
Reverse battery (pin 3 to 1) ¹⁰⁾	$-V_{bb}$	--	--	32	V
Reverse battery voltage drop ($V_{out} > V_{bb}$) $I_L = -4\text{ A}$	$T_j = 150\text{ °C}$: $-V_{ON(rev)}$	--	610	--	mV
Diagnostic Characteristics					
Open load detection current (on-condition)	$T_j = -40\text{ °C}$: $T_j = 25\text{ .. }150\text{ °C}$: $I_{L(OL)}$	20 10	-- --	850 750	mA
Open load detection voltage ¹¹⁾ (off-condition) $T_j = -40\text{ .. }150\text{ °C}$:	$V_{OUT(OL)}$	2	3	4	V
Internal output pull down (pin 5 to 1), $V_{OUT} = 5\text{ V}$, $T_j = -40\text{ .. }150\text{ °C}$	R_O	4	10	30	k Ω

⁹⁾ Integrated protection functions are designed to prevent IC destruction under fault conditions described in the data sheet. Fault conditions are considered as "outside" normal operating range. Protection functions are not designed for continuous repetitive operation.

¹⁰⁾ Requires 150 Ω resistor in GND connection. The reverse load current through the intrinsic drain-source diode has to be limited by the connected load. Note that the power dissipation is higher compared to normal operating conditions due to the voltage drop across the intrinsic drain-source diode. The temperature protection is not active during reverse current operation! Input and Status currents have to be limited (see max. ratings page 2 and circuit page 7).

¹¹⁾ External pull up resistor required for open load detection in off state.

Parameter and Conditions	Symbol	Values			Unit
		min	typ	max	
at $T_j = 25\text{ °C}$, $V_{bb} = 12\text{ V}$ unless otherwise specified					
Input and Status Feedback¹²⁾					
Input resistance $T_j = -40..150\text{ °C}$, see circuit page 6	R_I	2.5	3.5	6	$\text{k}\Omega$
Input turn-on threshold voltage  $T_j = -40..$	$V_{IN(T+)}$	1.7	--	3.5	V
Input turn-off threshold voltage  $T_j = -40..+150\text{ °C}$	$V_{IN(T-)}$	1.5	--	--	V
Input threshold hysteresis	$\Delta V_{IN(T)}$	--	0.5	--	V
Off state input current (pin 2), $V_{IN} = 0.4\text{ V}$, $T_j = -40..+150\text{ °C}$	$I_{IN(off)}$	1	--	50	μA
On state input current (pin 2), $V_{IN} = 3.5\text{ V}$, $T_j = -40..+150\text{ °C}$	$I_{IN(on)}$	20	50	90	μA
Delay time for status with open load after switch off (see timing diagrams, page 11), $T_j = -40..+150\text{ °C}$	$t_{d(ST\ OL4)}$	100	520	1000	μs
Status invalid after positive input slope (open load) $T_j = -40 \dots +150\text{ °C}$:	$t_{d(ST)}$	--	250	600	μs
Status output (open drain)					
Zener limit voltage $T_j = -40\dots+150\text{ °C}$, $I_{ST} = +1.6\text{ mA}$:	$V_{ST(high)}$	5.4	6.1	--	V
ST low voltage $T_j = -40\dots+25\text{ °C}$, $I_{ST} = +1.6\text{ mA}$:	$V_{ST(low)}$	--	--	0.4	
$T_j = +150\text{ °C}$, $I_{ST} = +1.6\text{ mA}$:		--	--	0.6	

¹²⁾ If a ground resistor R_{GND} is used, add the voltage drop across this resistor.

Truth Table

	Input-	Output	Status
	level	level	426L1
Normal operation	L	L	H
	H	H	H
Open load	L	¹³⁾	H (L ¹⁴⁾)
	H	H	L
Short circuit to V _{bb}	L	H	L ¹⁵⁾
	H	H	H (L ¹⁶⁾)
Overtemperature	L	L	H
	H	L	L
Undervoltage	L	L	H
	H	L	H
Overvoltage	L	L	H
	H	L	H

L = "Low" Level X = don't care Z = high impedance, potential depends on external circuit
H = "High" Level Status signal after the time delay shown in the diagrams (see fig 5. page 11...12)

Terms

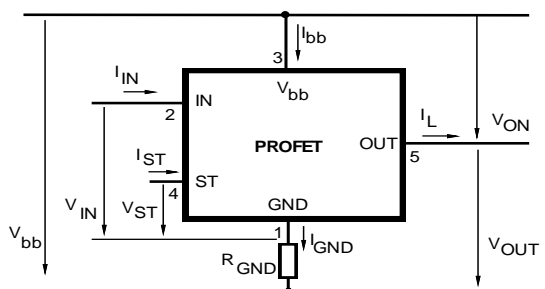

Input circuit (ESD protection)

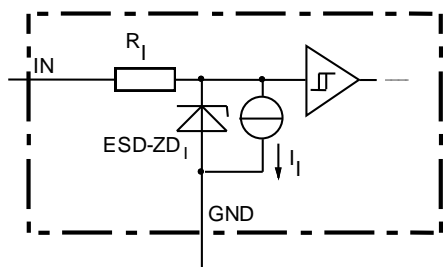

ESD zener diodes are not to be used as voltage clamp at DC conditions. Operation in this mode may result in a drift of the zener voltage (increase of up to 1 V).

Status output

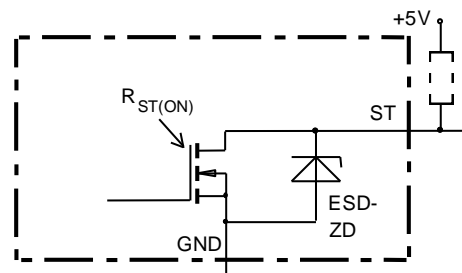

ESD-Zener diode: 6.1 V typ., max 5 mA; R_{ST(ON)} < 380 Ω at 1.6 mA, ESD zener diodes are not to be used as voltage clamp at DC conditions. Operation in this mode may result in a drift of the zener voltage (increase of up to 1 V).

Inductive and overvoltage output clamp

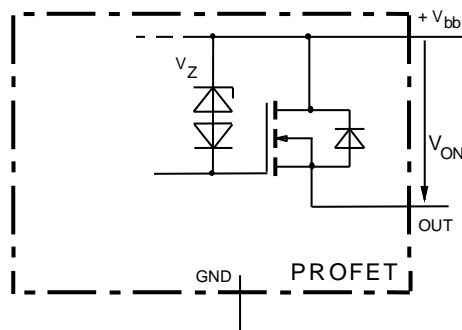

V_{ON} clamped to 47 V typ.

¹³⁾ Power Transistor off, high impedance
¹⁴⁾ with external resistor between pin 3 and pin 5
¹⁵⁾ An external short of output to V_{bb}, in the off state, causes an internal current from output to ground. If R_{GND} is used, an offset voltage at the GND and ST pins will occur and the V_{ST low} signal may be erroneous.
¹⁶⁾ Low resistance to V_{bb} may be detected in ON-state by the no-load-detection

Overvolt. and reverse batt. protection

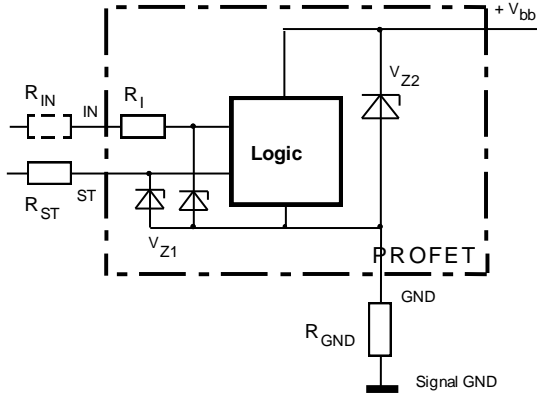

$V_{Z1} = 6.2 \text{ V typ.}$, $V_{Z2} = 47 \text{ V typ.}$, $R_{GND} = 150 \Omega$, $R_{ST} = 15 \text{ k}\Omega$, $R_I = 3.5 \text{ k}\Omega \text{ typ.}$

Open-load detection

ON-state diagnostic condition: $V_{ON} < R_{ON} * I_{L(OL)}$; IN high

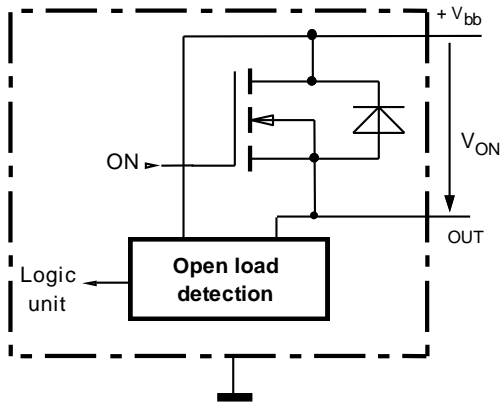

OFF-state diagnostic condition: $V_{OUT} > 3 \text{ V typ.}$; IN low

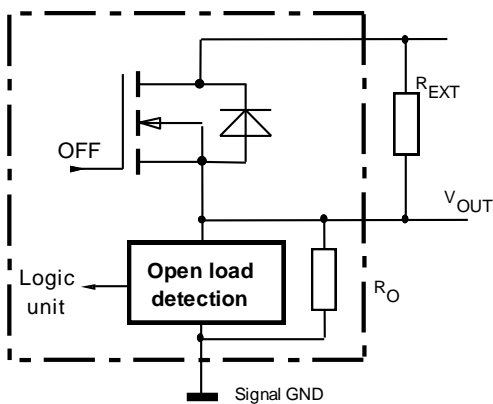

GND disconnect

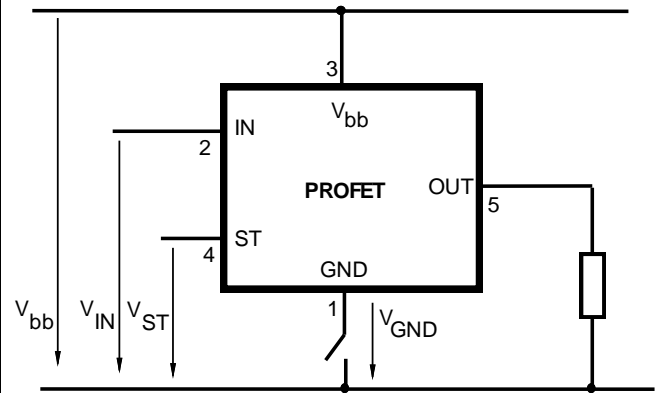

Any kind of load. In case of Input=high is $V_{OUT} \approx V_{IN} - V_{IN(T+)}$.
Due to $V_{GND} > 0$, no $V_{ST} = \text{low signal}$ available.

GND disconnect with GND pull up

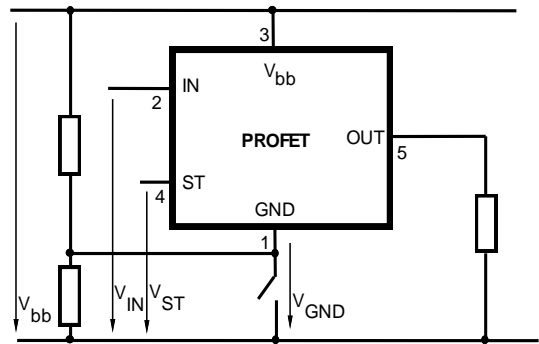

Any kind of load. If $V_{GND} > V_{IN} - V_{IN(T+)}$ device stays off
Due to $V_{GND} > 0$, no $V_{ST} = \text{low signal}$ available.

Vbb disconnect with energized inductive load

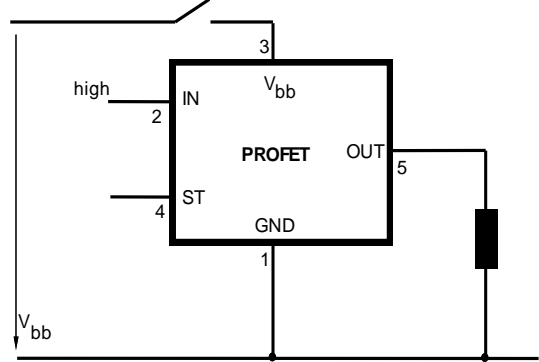

Normal load current can be handled by the PROFET itself.

V_{bb} disconnect with charged external inductive load

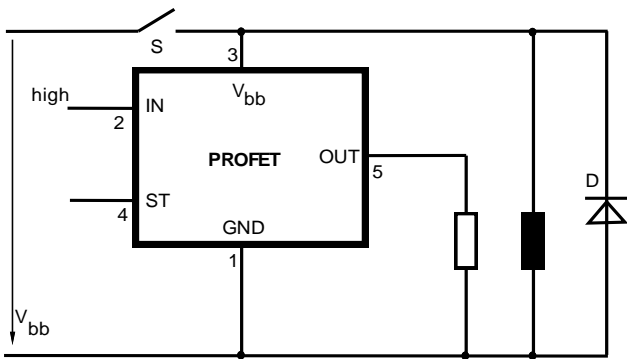

If other external inductive loads L are connected to the PROFET, additional elements like D are necessary.

Inductive Load switch-off energy dissipation

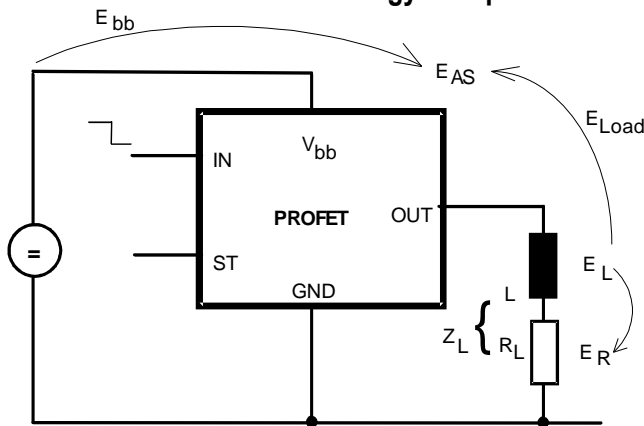

Energy stored in load inductance:

$$E_L = \frac{1}{2} \cdot L \cdot I_L^2$$

While demagnetizing load inductance, the energy dissipated in PROFET is

$$E_{AS} = E_{bb} + E_L - E_R = \int V_{ON(CL)} \cdot i_L(t) dt,$$

with an approximate solution for $R_L > 0 \Omega$:

$$E_{AS} = \frac{I_L \cdot L}{2 \cdot R_L} \cdot (V_{bb} + |V_{OUT(CL)}|) \cdot \ln \left(1 + \frac{I_L \cdot R_L}{|V_{OUT(CL)}|} \right)$$

Maximum allowable load inductance for a single switch off

$L = f(I_L)$; $T_{j,start} = 150^\circ\text{C}$, $T_C = 150^\circ\text{C}$ const.,
 $V_{bb} = 12\text{V}$, $R_L = 0 \Omega$

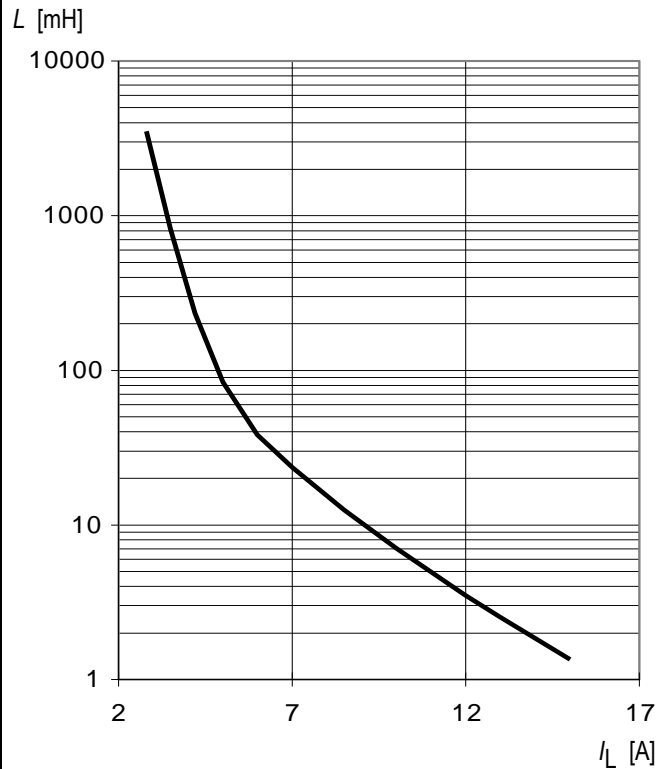

Typ. transient thermal impedance chip case

$Z_{thJC} = f(t_p) Z_{thJC} [K/W]$

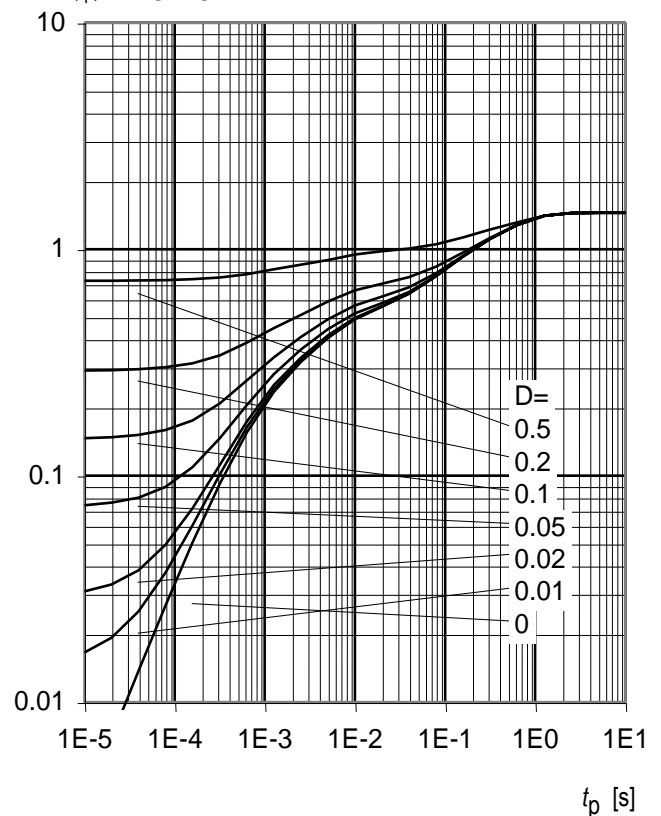

Transient thermal impedance chip ambient air

$$Z_{thJA} = f(t_p) Z_{thJA} [K/W]$$

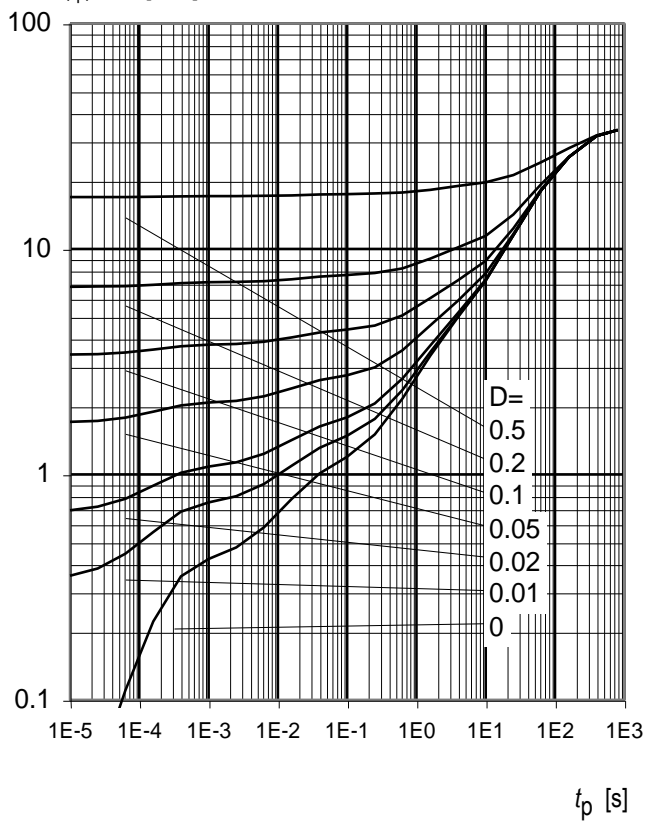

Timing diagrams

Figure 1a: V_{bb} turn on:

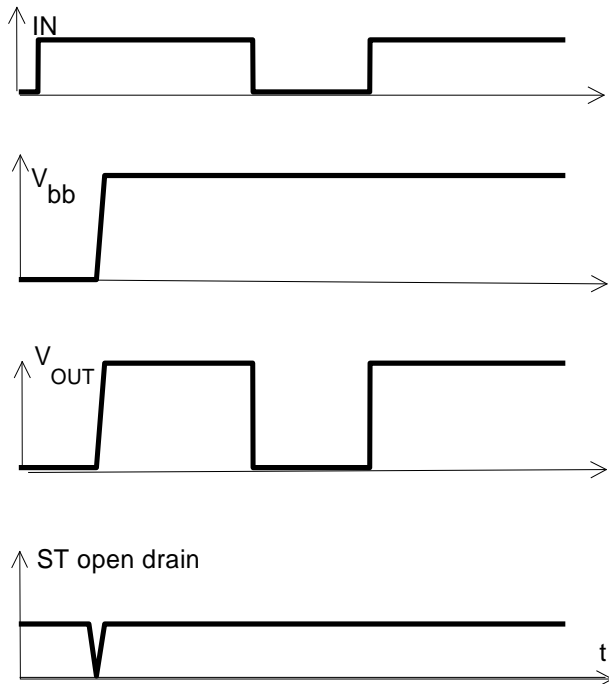

proper turn on under all conditions

Figure 2a: Switching a lamp,

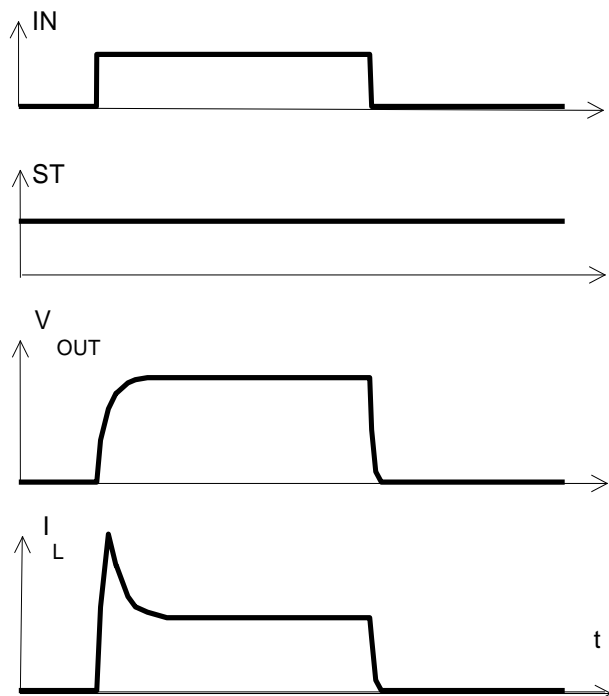
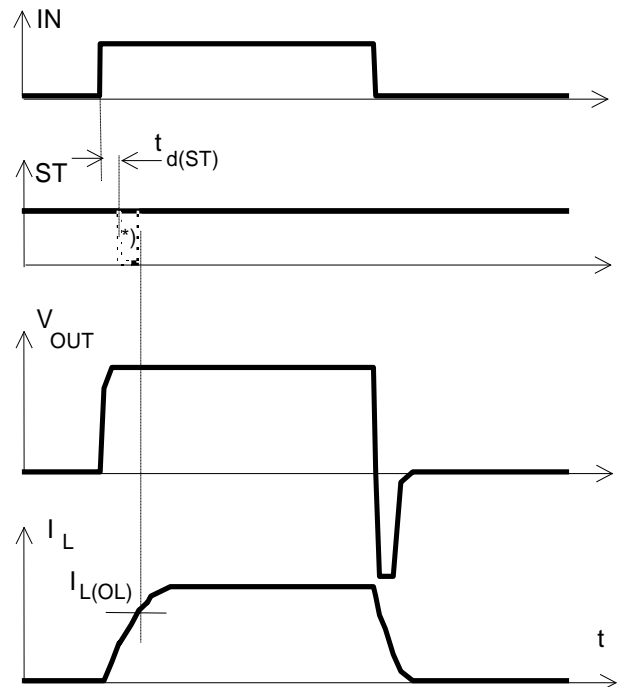
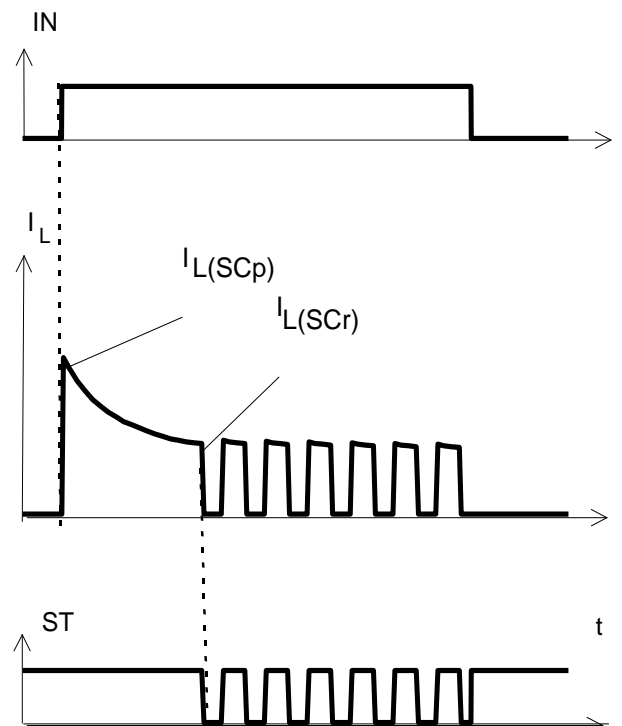

Figure 2b: Switching an inductive load



*) if the time constant of load is too large, open-load-status may occur

Figure 3a: Short circuit shut down by overtemperature, reset by cooling



Heating up may require several milliseconds, depending on external conditions

Figure 4a: Overtemperature:
Reset if $T_J < T_{jt}$

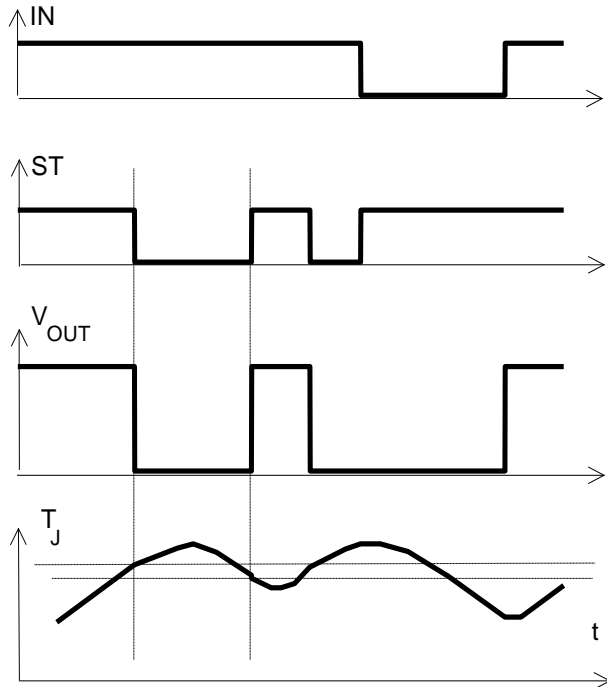
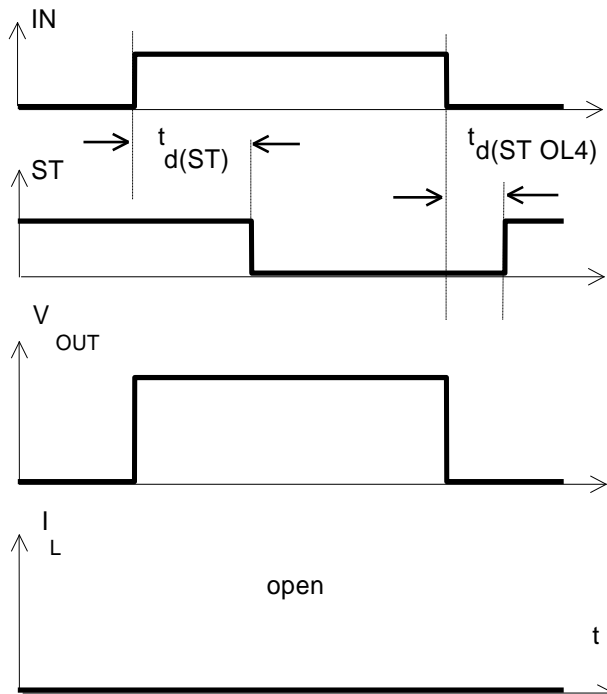
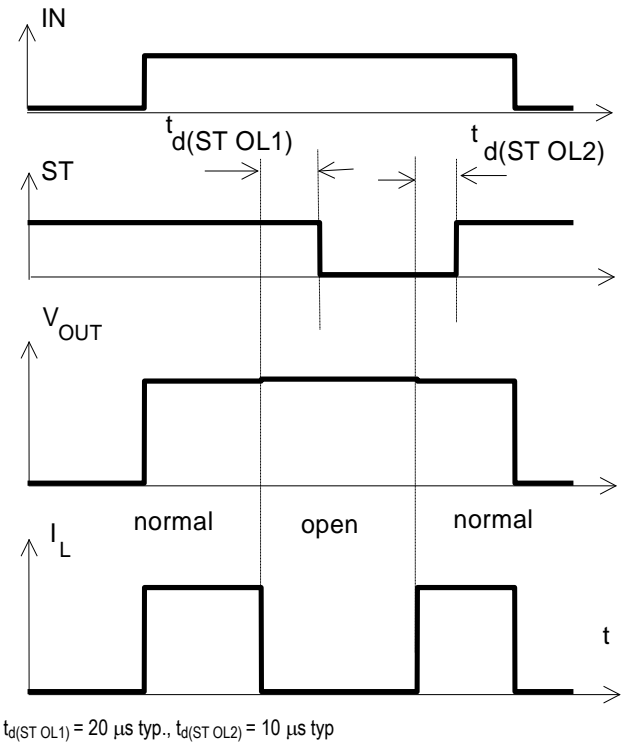

Figure 5a: Open load: detection in ON-state, turn on/off to open load



The status delay time $t_{d(ST OL4)}$ allows to distinguish between the failure modes "open load" and "overtemperature".

Figure 5b: Open load: detection in ON-state, open load occurs in on-state



$t_{d(ST OL1)} = 20 \mu s$ typ., $t_{d(ST OL2)} = 10 \mu s$ typ

Figure 5c: Open load: detection in ON- and OFF-state (with REXT), turn on/off to open load

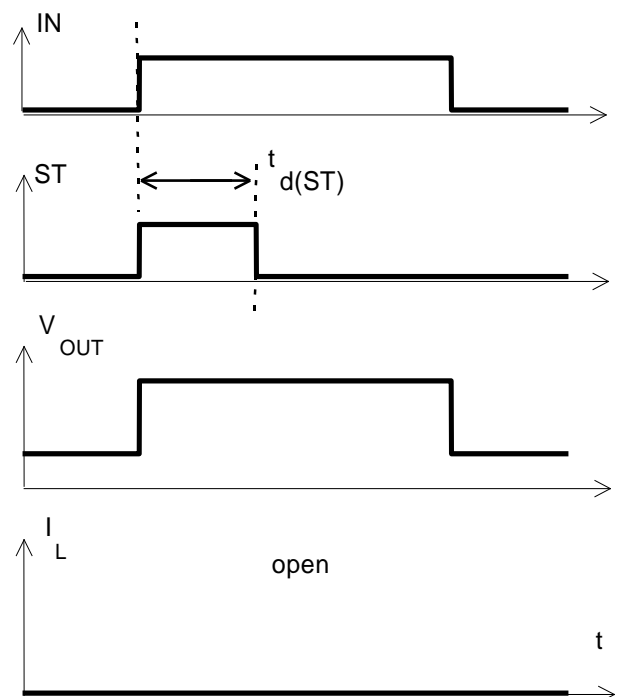

Figure 6a: Undervoltage:

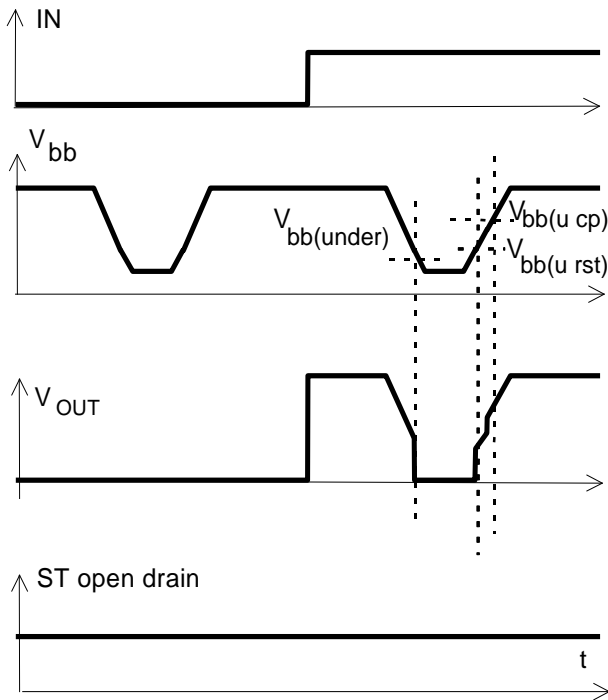

Figure 7a: Overvoltage:

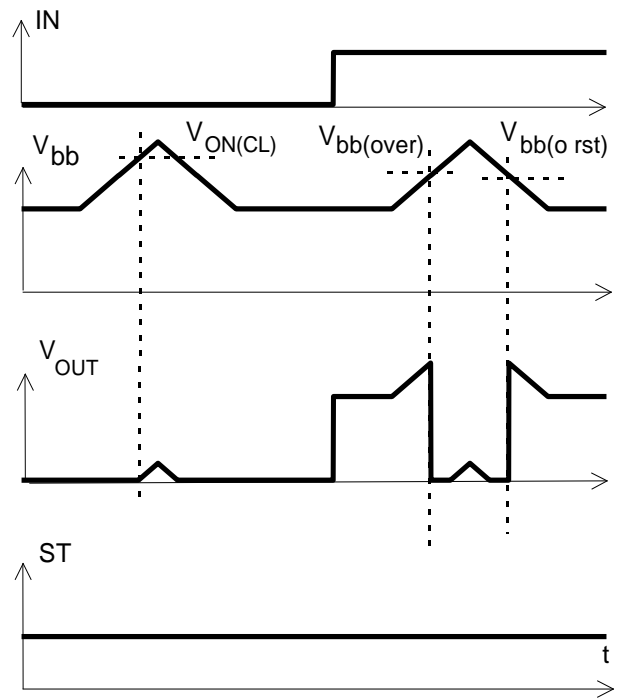
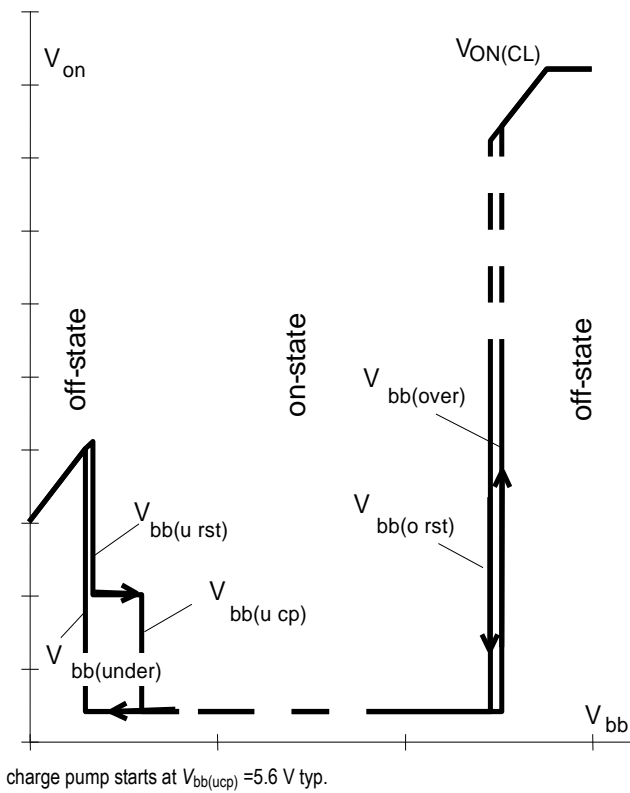

Figure 6b: Undervoltage restart of charge pump



Package and Ordering Code

All dimensions in mm

PG-TO263-5-2

Ordering code

BTS426L1 E3062A	SP001104820
-----------------	-------------

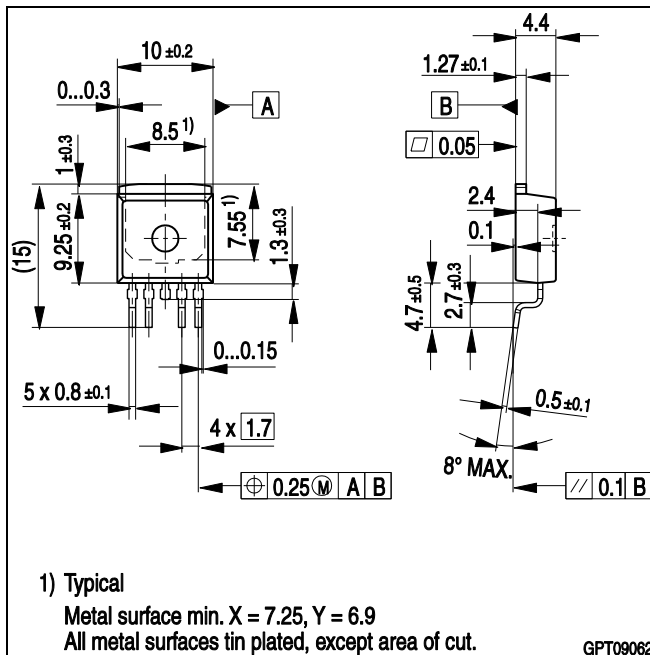

Published by
Infineon Technologies AG,
D-81726 München
© Infineon Technologies AG 2013
All Rights Reserved.

Attention please!

The information herein is given to describe certain components and shall not be considered as a guarantee of characteristics.

Terms of delivery and rights to technical change reserved.

We hereby disclaim any and all warranties, including but not limited to warranties of non-infringement, regarding circuits, descriptions and charts stated herein.

Infineon Technologies is an approved CECC manufacturer.

Information

For further information on technology, delivery terms and conditions and prices please contact your nearest Infineon Technologies Office in Germany or our Infineon Technologies Representatives worldwide (see address list).

Warnings

Due to technical requirements components may contain dangerous substances. For information on the types in question please contact your nearest Infineon Technologies Office.

Infineon Technologies Components may only be used in life-support devices or systems with the express written approval of Infineon Technologies, if a failure of such components can reasonably be expected to cause the failure of that life-support device or system, or to affect the safety or effectiveness of that device or system. Life support devices or systems are intended to be implanted in the human body, or to support and/or maintain and sustain and/or protect human life. If they fail, it is reasonable to assume that the health of the user or other persons may be endangered.

Looking for pricing, stock, or lifecycle information?

Click below to explore more details on WIN SOURCE:

- [View BTS426L1E3062ABUMA1 on WIN SOURCE](#)
- [Infineon Technologies Information](#)

Optimize Your Supply Chain with WIN SOURCE Solutions

- ✓ Global Sourcing Solution
- ✓ Obsolete Management
- ✓ Cost Control Management
- ✓ Shortage Management
- ✓ Alternative Solution
- ✓ Excess Inventory Management