



**THE DATASHEET OF
BQ27505YZGT-J4**



System-Side Impedance Track™ Fuel Gauge

1 INTRODUCTION

1.1 FEATURES

- Battery Fuel Gauge for 1-Series Li-Ion Applications
- Resides on System Main Board
 - Works With Embedded or Removable Battery Packs
- Microcontroller Peripheral Provides:
 - Accurate Battery Fuel Gauging
 - Internal Temperature Sensor for Battery Temperature Reporting
 - *Battery Low* Interrupt Warning
 - *Battery Insertion* Indicator
 - *Configurable Level of State of Charge (SOC) Interrupts*
 - *State of Health* Indicator
 - 96 Bytes of Non-Volatile Scratch-Pad FLASH
- Battery Fuel Gauge Based on Patented Impedance Track™ Technology
 - Models the Battery Discharge Curve for Accurate Time-to-Empty Predictions
 - Automatically Adjusts for Battery Aging, Battery Self-Discharge, and Temperature/Rate Inefficiencies
 - Low-Value Sense Resistor (10 mΩ or Less)
- 400-kHz I²C™ Interface for Connection to System Microcontroller Port
- In a 12-Pin NanoFree™ (CSP) Packaging

1.2 APPLICATIONS

- Smartphones and PDAs
- Digital Still and Video Cameras
- Handheld Terminals
- MP3 or Multimedia Players

1.3 DESCRIPTION

The Texas Instruments bq27505-J4 system-side Li-Ion battery fuel gauge is a microcontroller peripheral that provides fuel gauging for single-cell Li-Ion battery packs. The device requires little system micro-controller firmware development. The bq27505-J4 resides on the system's main board and manages an embedded battery (nonremovable) or a removable battery pack.

The bq27505-J4 uses the patented Impedance Track algorithm for fuel gauging, and provides information such as remaining battery capacity (mAh), state-of-charge (%), run-time to empty (min), battery voltage (mV), temperature (°C) and state of health(%).

Battery fuel gauging with the bq27505-J4 requires only PACK+ (P+), PACK– (P–), and Thermistor (T) connections to a removable battery pack or embedded battery circuit. The CSP option is a 12-ball package in the dimensions of 2.43mm x 1.96mm with 0.5mm lead pitch. It is ideal for space constrained applications.

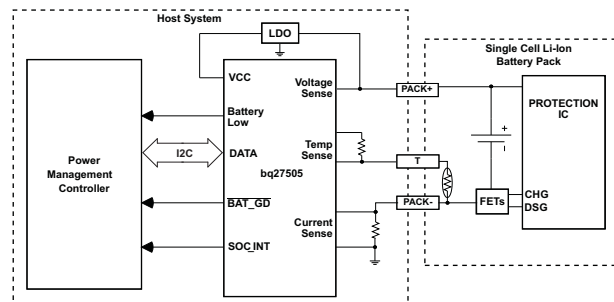

Figure 1-1. Typical Application



Please be aware that an important notice concerning availability, standard warranty, and use in critical applications of Texas Instruments semiconductor products and disclaimers thereto appears at the end of this data sheet.

Impedance Track, NanoFree are trademarks of Texas Instruments.
I²C is a trademark of Philips Electronics.

1 INTRODUCTION	1	4 GENERAL DESCRIPTION	8
1.1 FEATURES	1	4.1 DATA COMMANDS	9
1.2 APPLICATIONS	1	4.2 DATA FLASH INTERFACE	18
1.3 DESCRIPTION	1	4.3 MANUFACTURER INFORMATION BLOCKS	19
2 DEVICE INFORMATION	3	4.4 ACCESS MODES	19
2.1 AVAILABLE OPTIONS	3	4.5 SEALING/UNSEALING DATA FLASH	19
2.2 DISSIPATION RATINGS	3	4.6 DATA FLASH SUMMARY	20
2.3 PIN ASSIGNMENT	3	5 FUNCTIONAL DESCRIPTION	22
3 ELECTRICAL SPECIFICATIONS	4	5.1 FUEL GAUGING	22
3.1 ABSOLUTE MAXIMUM RATINGS	4	5.2 IMPEDANCE TRACK™ VARIABLES	23
3.2 RECOMMENDED OPERATING CONDITIONS	4	5.3 DETAILED PIN DESCRIPTION	25
3.3 POWER-ON RESET	5	5.4 TEMPERATURE MEASUREMENT	28
3.4 INTERNAL TEMPERATURE SENSOR CHARACTERISTICS	5	5.5 OVERTEMPERATURE INDICATION	29
3.5 HIGH-FREQUENCY OSCILLATOR	5	5.6 CHARGING AND CHARGE-TERMINATION INDICATION	29
3.6 LOW-FREQUENCY OSCILLATOR	5	5.7 POWER MODES	29
3.7 INTEGRATING ADC (COULOMB COUNTER) CHARACTERISTICS	5	5.8 POWER CONTROL	31
3.8 ADC (TEMPERATURE AND CELL MEASUREMENT) CHARACTERISTICS	6	5.9 AUTOCALIBRATION	32
3.9 DATA FLASH MEMORY CHARACTERISTICS	6	6 APPLICATION-SPECIFIC INFORMATION	32
3.10 400 kHz I ² C-COMPATIBLE INTERFACE COMMUNICATION TIMING CHARACTERISTICS	7	6.1 BATTERY PROFILE STORAGE AND SELECTION	32
3.11 100 kHz I ² C-COMPATIBLE INTERFACE COMMUNICATION TIMING CHARACTERISTICS	7	6.2 APPLICATION-SPECIFIC FLOW AND CONTROL	33
		7 COMMUNICATIONS	33
		7.1 I ² C INTERFACE	33
		7.2 I ² C Time Out	34
		8 REFERENCE SCHEMATICS	35
		8.1 SCHEMATIC	35

2 DEVICE INFORMATION

2.1 AVAILABLE OPTIONS

PART NUMBER	FIRMWARE VERSION	PACKAGE ⁽¹⁾	T _A	COMMUNICATION FORMAT	TAPE & REEL QUANTITY
bq27505YZGR-J4	2.24	CSP-12	–40°C to 85°C	I ² C	3000
bq27505YZGT-J4					250

(1) For the most current package and ordering information, see the Package Option Addendum at the end of this document, or see the TI website at www.ti.com.

2.2 DISSIPATION RATINGS

PACKAGE	THERMAL RESISTANCE ^{(1) (2)}		POWER RATING T _A = 25°C	DERATING FACTOR ABOVE ^{(1) (2)} T _A = 25°C
YZG	θ _{JA} = 89°C/W	θ _{JB} = 35°C/W	1.1 W	12 mW/°C

(1) Measured with high-K board.

(2) Maximum power dissipation is a function of T_{J(max)}, θ_{JA} and T_A. The maximum allowable power dissipation at any allowable ambient temperature is P_D = (T_{J(max)} – T_A) / θ_{JA}.

2.3 PIN ASSIGNMENT

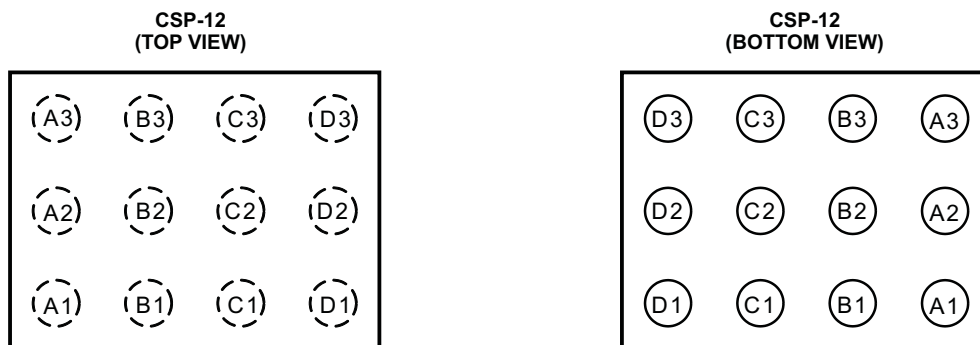

Table 2-1. PIN FUNCTIONS

PIN		TYPE ⁽¹⁾	DESCRIPTION
NAME	NO.		
SRP	A1	IA	Analog input pin connected to the internal coulomb counter where SRP is nearest the PACK– connection. Connect to 5-mΩ to 20-mΩ sense resistor.
SRN	B1	IA	Analog input pin connected to the internal coulomb counter where SRN is nearest the V _{SS} connection. Connect to 5-mΩ to 20-mΩ sense resistor.
BAT_LOW	C1	O	Battery Low output indicator. Active <i>high</i> by default, though polarity can be configured through the [BATL_POL] bit of Operation Configuration . Push-pull output.
V _{SS}	D1	P	Device ground
/BAT_GD	A2	O	Battery-good indicator. Active- <i>low</i> by default, though polarity can be configured through the [BATG_POL] bit of Operation Configuration . Push-pull output.
SOC_INT	B2	I/O	SOC state interrupts output. Generate a pulse under the conditions specified by Table 5-5 . Open drain output.
BAT	C2	I	Cell-voltage measurement input. ADC input. Recommend 4.8V maximum for conversion accuracy.
V _{CC}	D2	P	Processor power input. Decouple with minimum 0.1μF ceramic capacitor.
SDA	A3	I/O	Slave I ² C serial communications data line for communication with system (Master). Open-drain I/O. Use with 10kΩ pull-up resistor (typical).
SCL	B3	I	Slave I ² C serial communications clock input line for communication with system (Master). Use with 10kΩ pull-up resistor (typical).
BI/TOUT	C3	I/O	Battery-insertion detection input. Power pin for pack thermistor network. Thermistor-multiplexer control pin. Use with pull-up resistor >1MΩ (1.8 MΩ typical).

(1) I/O = Digital input/output, IA = Analog input, P = Power connection

PIN FUNCTIONS (continued)

PIN		TYPE ⁽¹⁾	DESCRIPTION
NAME	NO.		
TS	D3	IA	Pack thermistor voltage sense (use 103AT-type thermistor). ADC input

3 ELECTRICAL SPECIFICATIONS**3.1 ABSOLUTE MAXIMUM RATINGS**

over operating free-air temperature range (unless otherwise noted)⁽¹⁾

PARAMETER		VALUE	UNIT
V _{CC}	Supply voltage range	−0.3 to 2.75	V
V _{IOD}	Open-drain I/O pins (SDA, SCL, SOC_INT)	−0.3 to 6	V
V _{BAT}	BAT input pin	−0.3 to 6	
V _I	Input voltage range to all other pins (BI/Tout, TS, SRP, SRN, /BAT_GD)	−0.3 to V _{CC} + 0.3	V
ESD	Human-body model (HBM), BAT pin	1.5	kV
	Human-body model (HBM), all other pins	2	
T _A	Operating free-air temperature range	−40 to 85	°C
T _F	Functional temperature range	−40 to 100	°C
T _{stg}	Storage temperature range	−65 to 150	°C

(1) Stresses beyond those listed under "absolute maximum ratings" may cause permanent damage to the device. These are stress ratings only, and functional operation of the device at these or any other conditions beyond those indicated under "recommended operating conditions" is not implied. Exposure to absolute-maximum-rated conditions for extended periods may affect device reliability.

3.2 RECOMMENDED OPERATING CONDITIONS

T_A = −40°C to 85°C; 2.4 V < V_{CC} < 2.6 V; Typical values at T_A = 25°C and V_{CC} = 2.5 V (unless otherwise noted)

PARAMETER		TEST CONDITIONS	MIN	TYP	MAX	UNIT
V _{CC}	Supply voltage		2.4	2.5	2.6	V
I _{CC}	Normal operating-mode current	Fuel gauge in NORMAL mode. I _{LOAD} > Sleep Current		114		μA
I _{SLEEP+}	Sleep+ operating mode current	Fuel gauge in SLEEP+ mode. I _{LOAD} < Sleep Current		58		μA
I _{SLEEP}	Low-power storage-mode current	Fuel gauge in SLEEP mode. I _{LOAD} < Sleep Current		19		μA
I _{HIB}	Hibernate operating-mode current	Fuel gauge in HIBERNATE mode. I _{LOAD} < Hibernate Current		4		μA
V _{OL}	Output voltage, low (SCL, SDA, SOC_INT, BAT_LOW)	I _{OL} = 0.5 mA			0.4	V
V _{OH(PP)}	Output voltage, high (BAT_LOW, /BAT_GD)	I _{OH} = −1 mA	V _{CC} − 0.5			V
V _{OH(OD)}	Output voltage, high (SDA, SCL, SOC_INT)	External pullup resistor connected to V _{CC}	V _{CC} − 0.5			V
V _{IL}	Input voltage, low (SDA, SCL)		−0.3		0.6	V
	Input voltage, low (BI/TOUT)	BAT INSERT CHECK MODE active	−0.3		0.6	
V _{IH(OD)}	Input voltage, high (SDA, SCL)		1.2		6	
	Input voltage, high (BI/TOUT)	BAT INSERT CHECK MODE active	1.2		V _{CC} + 0.3	
V _{A1}	Input voltage range (TS)		V _{SS} − 0.125		2	V
V _{A2}	Input voltage range (BAT)		V _{SS} − 0.125		5	V
V _{A3}	Input voltage range (SRP, SRN)		V _{SS} − 0.125		0.125	V
I _{lkg}	Input leakage current (I/O pins)				0.3	μA
t _{PUCD}	Power-up communication delay			250		ms

3.3 POWER-ON RESET

 $T_A = -40^{\circ}\text{C}$ to 85°C , typical values at $T_A = 25^{\circ}\text{C}$ and $V_{\text{BAT}} = 3.6\text{ V}$ (unless otherwise noted)

PARAMETER	TEST CONDITIONS	MIN	TYP	MAX	UNIT
$V_{\text{IT+}}$ Positive-going battery voltage input at V_{CC}		2.09	2.20	2.31	V
V_{HYS} Power-on reset hysteresis		45	115	185	mV

3.4 INTERNAL TEMPERATURE SENSOR CHARACTERISTICS

 $T_A = -40^{\circ}\text{C}$ to 85°C , $2.4\text{ V} < V_{\text{CC}} < 2.6\text{ V}$; typical values at $T_A = 25^{\circ}\text{C}$ and $V_{\text{CC}} = 2.5\text{ V}$ (unless otherwise noted)

PARAMETER	TEST CONDITIONS	MIN	TYP	MAX	UNIT
G_{TEMP} Temperature sensor voltage gain			-2		mV/ $^{\circ}\text{C}$

3.5 HIGH-FREQUENCY OSCILLATOR

 $T_A = -40^{\circ}\text{C}$ to 85°C , $2.4\text{ V} < V_{\text{CC}} < 2.6\text{ V}$; typical values at $T_A = 25^{\circ}\text{C}$ and $V_{\text{CC}} = 2.5\text{ V}$ (unless otherwise noted)

PARAMETER	TEST CONDITIONS	MIN	TYP	MAX	UNIT
f_{OSC} Operating frequency			2.097		MHz
f_{EIO} Frequency error ^{(1) (2)}	$T_A = 0^{\circ}\text{C}$ to 60°C	-2%	0.38%	2%	
	$T_A = -20^{\circ}\text{C}$ to 70°C	-3%	0.38%	3%	
	$T_A = -40^{\circ}\text{C}$ to 85°C	-4.5%	0.38%	4.5%	
t_{SXO} Start-up time ⁽³⁾			2.5	5	ms

(1) The frequency error is measured from 2.097 MHz.

(2) The frequency drift is included and measured from the trimmed frequency at $V_{\text{CC}} = 2.5\text{ V}$, $T_A = 25^{\circ}\text{C}$.

(3) The start-up time is defined as the time it takes for the oscillator output frequency to be within $\pm 3\%$ of typical oscillator frequency.

3.6 LOW-FREQUENCY OSCILLATOR

 $T_A = -40^{\circ}\text{C}$ to 85°C , $2.4\text{ V} < V_{\text{CC}} < 2.6\text{ V}$; typical values at $T_A = 25^{\circ}\text{C}$ and $V_{\text{CC}} = 2.5\text{ V}$ (unless otherwise noted)

PARAMETER	TEST CONDITIONS	MIN	TYP	MAX	UNIT
f_{LOSC} Operating frequency			32.768		kHz
f_{LEIO} Frequency error ^{(1) (2)}	$T_A = 0^{\circ}\text{C}$ to 60°C	-1.5%	0.25%	1.5%	
	$T_A = -20^{\circ}\text{C}$ to 70°C	-2.5%	0.25%	2.5%	
	$T_A = -40^{\circ}\text{C}$ to 85°C	-4%	0.25%	4.0%	
t_{LSXO} Start-up time ⁽³⁾				500	μs

(1) The frequency drift is included and measured from the trimmed frequency at $V_{\text{CC}} = 2.5\text{ V}$, $T_A = 25^{\circ}\text{C}$.

(2) The frequency error is measured from 32.768 kHz.

(3) The start-up time is defined as the time it takes for the oscillator output frequency to be within $\pm 3\%$ of typical oscillator frequency.

3.7 INTEGRATING ADC (COULOMB COUNTER) CHARACTERISTICS

 $T_A = -40^{\circ}\text{C}$ to 85°C , $2.4\text{ V} < V_{\text{CC}} < 2.6\text{ V}$; typical values at $T_A = 25^{\circ}\text{C}$ and $V_{\text{CC}} = 2.5\text{ V}$ (unless otherwise noted)

PARAMETER	TEST CONDITIONS	MIN	TYP	MAX	UNIT
V_{SR} Input voltage range, $V_{\text{(SRN)}}$ and $V_{\text{(SRP)}}$	$V_{\text{SR}} = V_{\text{(SRN)}} - V_{\text{(SRP)}}$	-0.125		0.125	V
$t_{\text{SR_CONV}}$ Conversion time	Single conversion		1		s
Resolution		14		15	bits
$V_{\text{OS(SR)}}$ Input offset			10		μV
INL Integral nonlinearity error			± 0.007	± 0.034	%FSR
$Z_{\text{IN(SR)}}$ Effective input resistance ⁽¹⁾		2.5			M Ω
$I_{\text{lkq(SR)}}$ Input leakage current ⁽¹⁾				0.3	μA

(1) Specified by design. Not tested in production.

3.8 ADC (TEMPERATURE AND CELL MEASUREMENT) CHARACTERISTICS

$T_A = -40^{\circ}\text{C}$ to 85°C , $2.4\text{ V} < V_{CC} < 2.6\text{ V}$; typical values at $T_A = 25^{\circ}\text{C}$ and $V_{CC} = 2.5\text{ V}$ (unless otherwise noted)

PARAMETER		TEST CONDITIONS	MIN	TYP	MAX	UNIT
$V_{IN(ADC)}$	Input voltage range		-0.2		1	V
t_{ADC_CONV}	Conversion time				125	ms
	Resolution		14		15	bits
$V_{OS(ADC)}$	Input offset			1		mV
Z_{ADC1}	Effective input resistance (TS) ⁽¹⁾		8			M Ω
Z_{ADC2}	Effective input resistance (BAT) ⁽¹⁾	bq27505-J4 not measuring cell voltage	8			M Ω
		bq27505-J4 measuring cell voltage		100		k Ω
$I_{lkg(ADC)}$	Input leakage current ⁽¹⁾				0.3	μA

(1) Specified by design. Not tested in production.

3.9 DATA FLASH MEMORY CHARACTERISTICS

$T_A = -40^{\circ}\text{C}$ to 85°C , $2.4\text{ V} < V_{CC} < 2.6\text{ V}$; typical values at $T_A = 25^{\circ}\text{C}$ and $V_{CC} = 2.5\text{ V}$ (unless otherwise noted)

PARAMETER		TEST CONDITIONS	MIN	TYP	MAX	UNIT
t_{DR}	Data retention ⁽¹⁾		10			Years
	Flash-programming write cycles ⁽¹⁾		20,000			Cycles
$t_{WORDPROG}$	Word programming time ⁽¹⁾				2	ms
I_{CCPROG}	Flash-write supply current ⁽¹⁾			5	10	mA

(1) Specified by design. Not production tested

3.10 400 kHz I²C-COMPATIBLE INTERFACE COMMUNICATION TIMING CHARACTERISTICS

T_A = -40°C to 85°C, 2.4 V < V_{CC} < 2.6 V; typical values at T_A = 25°C and V_{CC} = 2.5 V (unless otherwise noted)

PARAMETER		TEST CONDITIONS	MIN	TYP	MAX	UNIT
t _r	SCL/SDA rise time				300	ns
t _f	SCL/SDA fall time				300	ns
t _{w(H)}	SCL pulse duration (high)		600			ns
t _{w(L)}	SCL pulse duration (low)		1.3			µs
t _{su(STA)}	Setup for repeated start		600			ns
t _{d(STA)}	Start to first falling edge of SCL		600			ns
t _{su(DAT)}	Data setup time		100			ns
t _{h(DAT)}	Data hold time		0			ns
t _{su(STOP)}	Setup time for stop		600			ns
t _(BUF)	Bus free time between stop and start		1.3			µs
f _{SCL}	Clock frequency				400	kHz

3.11 100 kHz I²C-COMPATIBLE INTERFACE COMMUNICATION TIMING CHARACTERISTICS

T_A = -40°C to 85°C, 2.4 V < V_{CC} < 2.6 V; typical values at T_A = 25°C and V_{CC} = 2.5 V (unless otherwise noted)

PARAMETER		TEST CONDITIONS	MIN	TYP	MAX	UNIT
t _r	SCL/SDA rise time				1	µs
t _f	SCL/SDA fall time				300	ns
t _{w(H)}	SCL pulse duration (high)		4			µs
t _{w(L)}	SCL pulse duration (low)		4.7			µs
t _{su(STA)}	Setup for repeated start		4.7			µs
t _{d(STA)}	Start to first falling edge of SCL		4			µs
t _{su(DAT)}	Data setup time		250			ns
t _{h(DAT)}	Data hold time		0			ns
t _{su(STOP)}	Setup time for stop		4			µs
t _(BUF)	Bus free time between stop and start		4.7			µs
f _{SCL}	Clock frequency				100	kHz

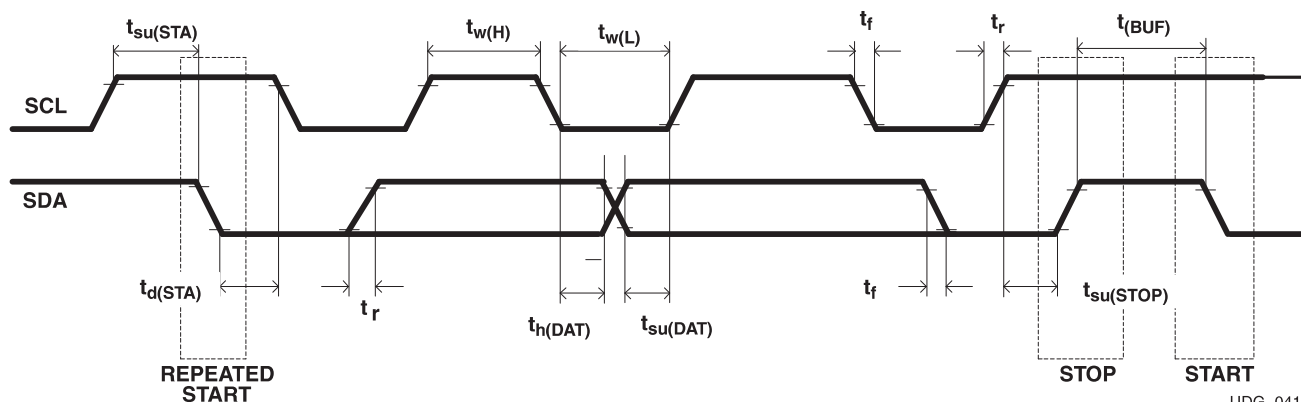

UDG-04122

Figure 3-1. I²C-Compatible Interface Timing Diagrams

4 GENERAL DESCRIPTION

The bq27505-J4 accurately predicts the battery capacity and other operational characteristics of a single Li-based rechargeable cell. It can be interrogated by a system processor to provide cell information, such as time-to-empty (TTE), time-to-full (TTF) and state-of-charge (SOC) as well as SOC interrupt signal to the host,

Information is accessed through a series of commands, called *Standard Commands*. Further capabilities are provided by the additional *Extended Commands* set. Both sets of commands, indicated by the general format *Command*(), are used to read and write information contained within the bq27505-J4 control and status registers, as well as its data flash locations. Commands are sent from system to gauge using the bq27505-J4's I2C serial communications engine, and can be executed during application development, pack manufacture, or end-equipment operation.

Cell information is stored in the bq27505-J4 in non-volatile flash memory. Many of these data flash locations are accessible during application development. They cannot, generally, be accessed directly during end-equipment operation. Access to these locations is achieved by either use of the bq27505-J4's companion evaluation software, through individual commands, or through a sequence of data-flash-access commands. To access a desired data flash location, the correct data flash subclass and offset must be known.

The bq27505-J4 provides two 32-byte user-programmable data flash memory blocks: **Manufacturer Info Block A** and **Manufacturer Info Block B**. This data space is accessed through a data flash interface. For specifics on accessing the data flash, see section [MANUFACTURER INFORMATION BLOCKS](#).

The key to the bq27505-J4's high-accuracy gas gauging prediction is Texas Instrument's proprietary Impedance Track™ algorithm. This algorithm uses cell measurements, characteristics, and properties to create state-of-charge predictions that can achieve less than 1% error across a wide variety of operating conditions and over the lifetime of the battery.

The bq27505-J4 measures charge/discharge activity by monitoring the voltage across a small-value series sense resistor (5 mΩ to 20 mΩ typ.) located between the system's V_{SS} and the battery's PACK- terminal. When a cell is attached to the bq27505-J4, cell impedance is computed, based on cell current, cell open-circuit voltage (OCV), and cell voltage under loading conditions.

The bq27505-J4 external temperature sensing is optimized with the use of a high accuracy negative temperature coefficient (NTC) thermistor with $R_{25} = 10.0 \text{ k}\Omega \pm 1\%$. B25/85 = 3435K $\pm 1\%$ (such as Semitec NTC 103AT). The bq27505-J4 can also be configured to use its internal temperature sensor. When an external thermistor is used, a 18.2k pull up resistor between BT/TOUT and TS pins is also required. The bq27505-J4 uses temperature to monitor the battery-pack environment, which is used for fuel gauging and cell protection functionality.

To minimize power consumption, the bq27505-J4 has different power modes: NORMAL, SLEEP, SLEEP+, HIBERNATE, and BAT INSERT CHECK. The bq27505-J4 passes automatically between these modes, depending upon the occurrence of specific events, though a system processor can initiate some of these modes directly. More details can be found in section [POWER MODES](#).

NOTE

FORMATTING CONVENTIONS IN THIS DOCUMENT:

Commands: *italics* with parentheses and no breaking spaces, e.g., *RemainingCapacity*().

Data flash: *italics*, **bold**, and *breaking spaces*, e.g., **Design Capacity**

Register bits and flags: brackets and *italics*, e.g., [TDA]

Data flash bits: brackets, *italics* and **bold**, e.g., [LED1]

Modes and states: ALL CAPITALS, e.g., UNSEALED mode.

4.1 DATA COMMANDS

4.1.1 STANDARD DATA COMMANDS

The bq27505-J4 uses a series of 2-byte standard commands to enable system reading and writing of battery information. Each standard command has an associated command-code pair, as indicated in [Table 4-1](#). Because each command consists of two bytes of data, two consecutive I2C transmissions must be executed both to initiate the command function, and to read or write the corresponding two bytes of data. Additional options for transferring data, such as spooling, are described in Section of **Communication**. Standard commands are accessible in NORMAL operation. Read/Write permissions depend on the active access mode, SEALED or UNSEALED (for details on the SEALED and UNSEALED states, refer to section ACCESS MODES.)

Table 4-1. Standard Commands

NAME		COMMAND CODE	UNITS	SEALED ACCESS	UNSEALED ACCESS
<i>Control()</i>	CNTL	0x00 / 0x01	N/A	R/W	R/W
<i>AtRate()</i>	AR	0x02 / 0x03	mA	R/W	R/W
<i>AtRateTimeToEmpty()</i>	ARTTE	0x04 / 0x05	Minutes	R	R/W
<i>Temperature()</i>	TEMP	0x06 / 0x07	0.1 K	R	R/W
<i>Voltage()</i>	VOLT	0x08 / 0x09	mV	R	R/W
<i>Flags()</i>	FLAGS	0x0a / 0x0b	N/A	R	R/W
<i>NominalAvailableCapacity()</i>	NAC	0x0c / 0x0d	mAh	R	R/W
<i>FullAvailableCapacity()</i>	FAC	0x0e / 0x0f	mAh	R	R/W
<i>RemainingCapacity()</i>	RM	0x10 / 0x11	mAh	R	R/W
<i>FullChargeCapacity()</i>	FCC	0x12 / 0x13	mAh	R	R/W
<i>AverageCurrent()</i>	AI	0x14 / 0x15	mA	R	R/W
<i>TimeToEmpty()</i>	TTE	0x16 / 0x17	Minutes	R	R/W
<i>TimeToFull()</i>	TTF	0x18 / 0x19	Minutes	R	R/W
<i>StandbyCurrent()</i>	SI	0x1a / 0x1b	mA	R	R/W
<i>StandbyTimeToEmpty()</i>	STTE	0x1c / 0x1d	Minutes	R	R/W
<i>MaxLoadCurrent()</i>	MLI	0x1e / 0x1f	mA	R	R/W
<i>MaxLoadTimeToEmpty()</i>	MLTTE	0x20 / 0x21	Minutes	R	R/W
<i>AvailableEnergy()</i>	AE	0x22 / 0x23	mWh	R	R/W
<i>AveragePower()</i>	AP	0x24 / 0x25	mW	R	R/W
<i>TTEatConstantPower()</i>	TTECP	0x26 / 0x27	Minutes	R	R/W
<i>StateOfHealth()</i>	SOH	0x28 / 0x29	% / num	R	R/W
<i>StateOfCharge()</i>	SOC	0x2c / 0x2d	%	R	R/W
<i>NormalizedImpedanceCal()</i>	NIC	0x2e / 0x2f	mohm	R	R/W
<i>InstaneousCurrent Reading()</i>	ICR	0x30 / 0x31	mA	R	R/W

4.1.1.1 Control(): 0x00/0x01

Issuing a *Control()* command requires a subsequent 2-byte subcommand. These additional bytes specify the particular control function desired. The *Control()* command allows the system to control specific features of the bq27505-J4 during normal operation and additional features when the bq27505-J4 is in different access modes, as described in [Table 4-2](#).

Table 4-2. Control() Subcommands

CNTL FUNCTION	CNTL DATA	SEALED ACCESS	DESCRIPTION
CONTROL_STATUS	0x0000	Yes	Reports the status of DF checksum, hibernate, IT, etc.
DEVICE_TYPE	0x0001	Yes	Reports the device type (eg: bq27505-J4)
FW_VERSION	0x0002	Yes	Reports the firmware version on the device type
HW_VERSION	0x0003	Yes	Reports the hardware version of the device type
DF_CHECKSUM	0x0004	No	Enables a data flash checksum to be generated and reports on a read
PREV_MACWRITE	0x0007	No	Returns previous MAC command code
CHEM_ID	0x0008	Yes	Reports the chemical identifier of the Impedance Track™ configuration
BOARD_OFFSET	0x0009	No	Forces the device to measure and store the board offset
CC_INT_OFFSET	0x000a	No	Forces the device to measure the internal CC offset
WRITE_CC_OFFSET	0x000b	No	Forces the device to store the internal CC offset
OCV	0x000c	Yes	Request the gauge to take a OCV measurement
BAT_INSERT	0x000d	Yes	Forces the BAT_DET bit set when the [BIE] bit is 0
BAT_REMOVE	0x000e	Yes	Forces the BAT_DET bit clear when the [BIE] bit is 0
SET_HIBERNATE	0x0011	Yes	Forces CONTROL_STATUS [HIBERNATE] to 1
CLEAR_HIBERNATE	0x0012	Yes	Forces CONTROL_STATUS [HIBERNATE] to 0
SET_SLEEP+	0x0013	Yes	Forces CONTROL_STATUS [SNOOZE] to 1
CLEAR_SLEEP+	0x0014	Yes	Forces CONTROL_STATUS [SNOOZE] to 0
FACTORY_RESTORE	0x0015	No	Forces a Factory Restore of learned resistance and Qmax to defaults
SEALED	0x0020	No	Places the bq27505-J4 in SEALED access mode
IT_ENABLE	0x0021	No	Enables the Impedance Track™ algorithm
CAL_MODE	0x0040	No	Places the bq27505-J4 in calibration mode
RESET	0x0041	No	Forces a full reset of the bq27505-J4

4.1.1.1.1 CONTROL_STATUS: 0x0000

Instructs the fuel gauge to return status information to control addresses 0x00/0x01. The status word includes the following information.

Table 4-3. CONTROL_STATUS Bit Definitions

	bit7	bit6	bit5	bit4	bit3	bit2	bit1	bit0
High byte	–	FAS	SS	CSV	CCA	BCA	OCVCMDCOMP	OCVFAIL
Low byte	INITCOMP	HIBERNATE	SNOOZE	SLEEP	LDMD	RUP_DIS	VOK	QEN

FAS = Status bit indicating the bq27505-J4 is in FULL ACCESS SEALED state. Active when set.

SS = Status bit indicating the bq27505-J4 is in SEALED state. Active when set.

CSV = Status bit indicating a valid data flash checksum has been generated. Active when set.

CCA = Status bit indicating the bq27505-J4 Coulomb Counter Calibration routine is active. The CCA routine will take place approximately 3 minutes and 45 seconds after the initialization. Active when set.

BCA = Status bit indicating the bq27505-J4 board calibration routine is active. Active when set.

OCVCMDCOMP = Status bit indicating the bq27505-J4 has executed the OCV command. This bit can only be set with battery's presence. True when set.

OCVFAIL = Status bit indicating bq27505-J4 OCV reading is failed due to the current. True when set.

INITCOMP = Initialization completion bit indicating the initialization completed. True when set.

HIBERNATE = Status bit indicating a request for entry into HIBERNATE from SLEEP mode has been issued. True when set. Default is 0.

SNOOZE = Status bit indicating the bq27505-J4 SLEEP+ mode is enabled. True when set.

SLEEP = Status bit indicating the bq27505-J4 is in SLEEP mode. True when set.

LDMD = Status bit indicating the bq27505-J4 Impedance Track™ algorithm is using constant-power mode. True when set. Default is 0 (constant-current mode).

RUP_DIS = Status bit indicating the bq27505-J4 Ra table updates are disabled. Updates disabled when set.

VOK = Status bit indicating the bq27505-J4 voltages are okay for Qmax updates. True when set.

QEN = Status bit indicating the bq27505-J4 Qmax updates are enabled. True when set.

4.1.1.1.2 DEVICE_TYPE: 0x0001

Instructs the fuel gauge to return the device type to addresses 0x00/0x01.

4.1.1.1.3 FW_VERSION: 0x0002

Instructs the fuel gauge to return the firmware version to addresses 0x00/0x01.

4.1.1.1.4 HW_VERSION: 0x0003

Instructs the fuel gauge to return the hardware version to addresses 0x00/0x01.

4.1.1.1.5 DF_CHECKSUM: 0x0004

Instructs the fuel gauge to compute the checksum of the data flash memory. The checksum value is written and returned to addresses 0x00/0x01 (UNSEALED mode only). The checksum will not be calculated in SEALED mode; however, the checksum value can still be read.

4.1.1.1.6 PREV_MACWRITE: 0x0007

Instructs the fuel gauge to return the previous command written to addresses 0x00/0x01.

4.1.1.1.7 CHEM_ID: 0x0008

Instructs the fuel gauge to return the chemical identifier for the Impedance Track™ configuration to addresses 0x00/0x01.

4.1.1.1.8 BOARD_OFFSET: 0x0009

Instructs the fuel gauge to compute the coulomb counter offset with internal short and then without internal short applied across the sensing resistor (SR) inputs. The difference between the two measurements is the board offset. After a delay of approximately 32 seconds, this offset value is returned to addresses 0x00/0x01 and written to data flash. The CONTROL STATUS [BCA] is also set. The user must prevent any charge or discharge current from flowing during the process. This function is only available when the fuel gauge is UNSEALED. When SEALED, this command only reads back the board-offset value stored in data flash.

4.1.1.1.9 CC_INT_OFFSET: 0X000A

Control data of 0x000a instructs the fuel gauge to compute the coulomb counter offset with internal short applied across the SR inputs. The offset value is returned to addresses 0x00/0x01, after a delay of approximately 16 seconds. This function is only available when the fuel gauge is UNSEALED. When SEALED, this command only reads back the CC_INT_OFFSET value stored in data flash.

4.1.1.1.10 WRITE_OFFSET: 0X000B

Control data of 0x000b causes the fuel gauge to write the coulomb counter offset to data flash.

4.1.1.1.11 OCV_CMD: 0X000C

This command is to request the gauge to take a OCV reading. This command can only be issued after the [INICOMP] has been set, indicating the initialization has been completed. The OCV measurement take place at the beginning of the next repeated 1s firmware synchronization clock. The measurement takes about 183ms. During the same time period, the SOC_INT will be negated. The host should use this signal to reduce the load current below the C/20 in 8ms to ensure a valid OCV reading.

4.1.1.1.12 BAT_INSERT: 0X000D

This command is to force the BAT_DET bit to be set when the battery insertion detection is disabled. When the BIE is set to 0, the battery insertion detection is disabled. The gauge relies on the host to inform the battery insertion with this command to set the BAT_DET bit.

4.1.1.1.13 BAT_REMOVE: 0X000E

This command is to force the BAT_DET bit to be clear when the battery insertion detection is disabled. When the BIE is set to 0, the battery insertion detection is disabled. The gauge relies on the host to inform the battery removal with this command to clear the BAT_DET bit.

4.1.1.1.14 SET_HIBERNATE: 0x0011

Instructs the fuel gauge to force the CONTROL_STATUS [HIBERNATE] bit to 1. This will allow the gauge to enter the HIBERNATE power mode after the transition to SLEEP power state is detected. The [HIBERNATE] bit is automatically cleared upon exiting from HIBERNATE mode.

4.1.1.1.15 CLEAR_HIBERNATE: 0x0012

Instructs the fuel gauge to force the CONTROL_STATUS [HIBERNATE] bit to 0. This prevents the gauge from entering the HIBERNATE power mode after the transition to the SLEEP power state is detected. It can also be used to force the gauge out of HIBERNATE mode.

4.1.1.1.16 ENABLE_SLEEP+ MODE: 0X0013

Instructs the fuel gauge to set the CONTROL_STATUS [SNOOZE] bit to 1. This will enable the SLEEP+ mode. The gauge will enter SLEEP+ power mode after the transition conditions are meet.

4.1.1.1.17 DISABLE_SLEEP+ MODE: 0X0014

Instructs the fuel gauge to set the CONTROL_STATUS [SNOOZE] bit to 0. This will disable the SLEEP+ mode. The gauge will exit from the SLEEP+ power mode after the SNOOZ bit is cleared.

4.1.1.1.18 FACTORY RESTORE: 0X0015

Instructs the fuel gauge to reset learned resistance tables and Qmax values to the default values. SOC_INT is asserted while the restore is in progress. If gauge is sealed, the restore unsealed code must be sent before the factory restore command.

4.1.1.1.19 **SEALED: 0x0020**

Instructs the fuel gauge to transition from the UNSEALED state to the SEALED state. The fuel gauge must always be set to the SEALED state for use in end equipment.

4.1.1.1.20 **IT_ENABLE: 0x0021**

This command forces the fuel gauge to begin the Impedance Track™ algorithm, sets the active **UpdateStatus** *n* location to 0x01 and causes the [VOK] and [QEN] flags to be set in the CONTROL_STATUS register. [VOK] is cleared if the voltages are not suitable for a Qmax update. Once set, [QEN] cannot be cleared. This command is only available when the fuel gauge is UNSEALED.

4.1.1.1.21 **CAL_MODE: 0X0040**

This command instructs the fuel gauge to enter calibration mode. This command is only available when the fuel gauge is UNSEALED.

4.1.1.1.22 **RESET: 0x0041**

This command instructs the fuel gauge to perform a full reset. This command is only available when the fuel gauge is UNSEALED.

4.1.1.2 **AtRate(): 0x02/0x03**

The *AtRate()* read-/write-word function is the first half of a two-function command set used to set the *AtRate* value used in calculations made by the *AtRateTimeToEmpty()* function. The *AtRate()* units are in mA.

The *AtRate()* value is a signed integer, with negative values interpreted as a discharge current value. The *AtRateTimeToEmpty()* function returns the predicted operating time at the *AtRate* value of discharge. The default value for *AtRate()* is zero and forces *AtRateTimeToEmpty()* to return 65,535. Both the *AtRate()* and *AtRateTimeToEmpty()* commands must only be used in NORMAL mode.

4.1.1.3 **AtRateTimeToEmpty(): 0x04/0x05**

This read-word function returns an unsigned integer value of the predicted remaining operating time if the battery is discharged at the *AtRate()* value in minutes with a range of 0 to 65,534. A value of 65,535 indicates *AtRate()* = 0. The fuel gauge updates *AtRateTimeToEmpty()* within 1s after the system sets the *AtRate()* value. The fuel gauge automatically updates *AtRateTimeToEmpty()* based on the *AtRate()* value every 1s. Both the *AtRate()* and *AtRateTimeToEmpty()* commands must only be used in NORMAL mode.

4.1.1.4 **Temperature(): 0x06/0x07**

This read-only function returns an unsigned integer value of the temperature in units of 0.1K measured by the fuel gauge.

4.1.1.5 **Voltage(): 0x08/0x09**

This read-word function returns an unsigned integer value of the measured cell-pack voltage in mV with a range of 0 to 6000 mV.

4.1.1.6 *Flags()*: 0x0a/0x0b

This read-word function returns the contents of the fuel-gauge status register, depicting the current operating status.

Table 4-4. Flags Bit Definitions

	bit7	bit6	bit5	bit4	bit3	bit2	bit1	bit0
High byte	OTC	OTD	–	–	CHG_INH	XCHG	FC	CHG
Low byte	–	–	OCV_GD	WAIT_ID	BAT_DET	SOC1	SYSDOWN	DSG

OTC = Overtemperature in charge condition is detected. True when set.

OTD = Overtemperature in discharge condition is detected. True when set.

CHG_INH = Charge inhibit: unable to begin charging (temperature outside the range [*Charge Inhibit Temp Low, Charge Inhibit Temp High*]). True when set.

XCHG = Charge suspend alert (temp outside the range [*Suspend Temperature Low, Suspend Temperature High*]). True when set.

FC = Full-charged condition reached. Set when charge termination condition is met. (RMFCC=1; Set FC_Set % = -1% when RMFCC = 0). True when set

CHG = (Fast) charging allowed. True when set.

OCV_GD = Good OCV measurement taken. True when set.

WAIT_ID = Waiting to identify inserted battery. True when set.

BAT_DET = Battery detected. True when set.

SOC1 = State-of-Charge-Threshold 1 (**SOC1 Set**) reached. True when set.

SysDown = SystemDown bit indicating the system shut down. True when set

DSG = Discharging detected. True when set.

4.1.1.7 *NominalAvailableCapacity()*: 0x0c/0x0d

This read-only command pair returns the uncompensated (less than C/20 load) battery capacity remaining. Units are mAh.

4.1.1.8 *FullAvailableCapacity()*: 0x0e/0x0f

This read-only command pair returns the uncompensated (less than C/20 load) capacity of the battery when fully charged. Units are mAh. *FullAvailableCapacity()* is updated at regular intervals, as specified by the IT algorithm.

4.1.1.9 *RemainingCapacity()*: 0x10/0x11

This read-only command pair returns the compensated battery capacity remaining. Units are mAh.

4.1.1.10 *FullChargeCapacity()*: 0x12/13

This read-only command pair returns the compensated capacity of the battery when fully charged. Units are mAh. *FullChargeCapacity()* is updated at regular intervals, as specified by the IT algorithm.

4.1.1.11 *AverageCurrent()*: 0x14/0x15

This read-only command pair returns a signed integer value that is the average current flow through the sense resistor. It is updated every 1 second. Units are mA.

4.1.1.12 *TimeToEmpty()*: 0x16/0x17

This read-only function returns an unsigned integer value of the predicted remaining battery life at the present rate of discharge, in minutes. A value of 65,535 indicates battery is not being discharged.

4.1.1.13 *TimeToFull()*: 0x18/0x19

This read-only function returns an unsigned integer value of predicted remaining time until the battery reaches full charge, in minutes, based upon *AverageCurrent()*. The computation accounts for the taper current time extension from the linear TTF computation based on a fixed *AverageCurrent()* rate of charge accumulation. A value of 65,535 indicates the battery is not being charged.

4.1.1.14 StandbyCurrent(): 0x1a/0x1b

This read-only function returns a signed integer value of the measured standby current through the sense resistor. The *StandbyCurrent()* is an adaptive measurement. Initially it reports the standby current programmed in **Initial Standby**, and after spending several seconds in standby, reports the measured standby current.

The register value is updated every 1 second when the measured current is above the **Deadband** and is less than or equal to $2 \times$ **Initial Standby**. The first and last values that meet this criteria are not averaged in, since they may not be stable values. To approximate a 1 minute time constant, each new *StandbyCurrent()* value is computed by taking approximate 93% weight of the last standby current and approximate 7% of the current measured average current.

4.1.1.15 StandbyTimeToEmpty(): 0x1c/0x1d

This read-only function returns an unsigned integer value of the predicted remaining battery life at the standby rate of discharge, in minutes. The computation uses *Nominal Available Capacity* (NAC), the uncompensated remaining capacity, for this computation. A value of 65,535 indicates battery is not being discharged.

4.1.1.16 MaxLoadCurrent(): 0x1e/0x1f

This read-only function returns a signed integer value, in units of mA, of the maximum load conditions. The *MaxLoadCurrent()* is an adaptive measurement which is initially reported as the maximum load current programmed in **Initial Max Load Current**. If the measured current is ever greater than **Initial Max Load Current**, then *MaxLoadCurrent()* updates to the new current. *MaxLoadCurrent()* is reduced to the average of the previous value and **Initial Max Load Current** whenever the battery is charged to full after a previous discharge to an SOC less than 50%. This prevents the reported value from maintaining an unusually high value.

4.1.1.17 MaxLoadTimeToEmpty(): 0x20/0x21

This read-only function returns an unsigned integer value of the predicted remaining battery life at the maximum load current discharge rate, in minutes. A value of 65,535 indicates that the battery is not being discharged.

4.1.1.18 AvailableEnergy(): 0x22/0x23

This read-only function returns an unsigned integer value of the predicted charge or energy remaining in the battery. The value is reported in units of mWh.

4.1.1.19 AveragePower(): 0x24/0x25

This read-only function returns a signed integer value of the average power of the current discharge. A value of 0 indicates that the battery is not being discharged. The value is reported in units of mW.

4.1.1.20 TimeToEmptyAtConstantPower(): 0x26/0x27

This read-only function returns an unsigned integer value of the predicted remaining operating time if the battery is discharged at the *AveragePower()* value in minutes. A value of 65,535 indicates *AveragePower() = 0*. The fuel gauge automatically updates *TimeToEmptyatContantPower()* based on the *AveragePower()* value every 1 s.

4.1.1.21 StateOfHealth(): 0x28/0x29

0x28 SOH percentage: this read-only function returns an unsigned integer value, expressed as a percentage of the ration of predicted $FCC(25^{\circ}C, SOH\ current\ rate)$ over the $DesignCapacity()$. The $FCC(25^{\circ}C, SOH\ curent\ rate)$ is the calculated full charge capacity at 25°C and the $SOH\ current\ rate$ is specified in the data flash. The range of the returned SOH percentage is 0x00 to 0x64, indicating 0 to 100% correspondingly.

0x29 SOH Status: this read-only function returns an unsigned integer value, indicating the status of the SOH percentage. The meanings of the returned value are:

- 0x00: SOH not valid (initialization)
- 0x01: Instant SOH value ready
- 0x02: Initial SOH value ready
 - Calculation based on uncompensated Qmax
 - Updated at first grid point update after cell insertion
- 0x03: SOH value ready
 - Utilize the updated Qmax update
 - Calculation based on compensated Qmax
 - Updated after complete charge and relax is complete
- 0x04-0xFF: Reserved

4.1.1.22 StateOfCharge(): 0x2c/0x2d

This read-only function returns an unsigned integer value of the predicted remaining battery capacity expressed as a percentage of $FullChargeCapacity()$, with a range of 0 to 100%.

4.1.1.23 NormalizedImpedanceCal(): 0x2e/0x2f

This read-only function returns an unsigned integer value of the calculated normalized impedance to 0°C at the current Depth of Discharge, with the unit of mΩ.

4.1.1.24 InstaneousCurrent Reading() 0x30/0x31

This read-only function returns a signed integer value that is the instantaneous current flow through the sense resistor. The conversion time is 125ms. It is updated every 1 second. Units are mA.

4.1.2 EXTENDED DATA COMMANDS

Extended commands offer additional functionality beyond the standard set of commands. They are used in the same manner; however, unlike standard commands, extended commands are not limited to 2-byte words. The number of commands bytes for a given extended command ranges in size from single to multiple bytes, as specified in [Table 4-5](#).

Table 4-5. Extended Data Commands

NAME		COMMAND CODE	UNITS	SEALED ACCESS ^{(1) (2)}	UNSEALED ACCESS ^{(1) (2)}
Reserved	RSVD	0x34...0x3b	N/A	R	R
$DesignCapacity()$	DCAP	0x3c / 0x3d	mAh	R	R
$DataFlashClass()$ ⁽²⁾	DFCLS	0x3e	N/A	N/A	R/W
$DataFlashBlock()$ ⁽²⁾	DFBLK	0x3f	N/A	R/W	R/W
$Authenticate()/BlockData()$	A/DF	0x40...0x53	N/A	R/W	R/W
$AuthenticateChecksum()/BlockData()$	ACKS/DFD	0x54	N/A	R/W	R/W
$BlockData()$	DFD	0x40...0x5f	N/A	R	R/W

(1) SEALED and UNSEALED states are entered via commands to **Control()** 0x00/0x01.

(2) In sealed mode, data flash CANNOT be accessed through commands 0x3e and 0x3f.

Extended Data Commands (continued)

NAME		COMMAND CODE	UNITS	SEALED ACCESS ⁽¹⁾ (2)	UNSEALED ACCESS ⁽¹⁾ (2)
<i>BlockDataChecksum()</i>	DFDCKS	0x60	N/A	R/W	R/W
<i>BlockDataControl()</i>	DFDCNTL	0x61	N/A	N/A	R/W
<i>DeviceNameLength()</i>	DNAMELEN	0x62	N/A	R	R
<i>DeviceName()</i>	DNAME	0x63...0x69	N/A	R	R
<i>ApplicationStatus()</i>	APPSTAT	0x6a	N/A	R	R
Reserved	RSVD	0x6b...0x7f	N/A	R	R

4.1.2.1 DesignCapacity(): 0x3c/0x3d

SEALED and UNSEALED Access: This command returns the value is stored in *Design Capacity* and is expressed in mAh. This is intended to be the theoretical or nominal capacity of a new pack, but has no bearing on the operation of the fuel gauge functionality.

4.1.2.2 DataFlashClass(): 0x3e

UNSEALED Access: This command sets the data flash class to be accessed. The class to be accessed must be entered in hexadecimal.

SEALED Access: This command is not available in SEALED mode.

4.1.2.3 DataFlashBlock(): 0x3f

UNSEALED Access: This command sets the data flash block to be accessed. When 0x00 is written to *BlockDataControl()*, *DataFlashBlock()* holds the block number of the data flash to be read or written. Example: writing a 0x00 to *DataFlashBlock()* specifies access to the first 32-byte block, a 0x01 specifies access to the second 32-byte block, and so on.

SEALED Access: This command directs which data flash block is accessed by the *BlockData()* command. Writing a 0x00 to *DataFlashBlock()* specifies that the *BlockData()* command transfers authentication data. Issuing a 0x01 or 0x02 instructs the *BlockData()* command to transfer **Manufacturer Info Block A** or **B**, respectively.

4.1.2.4 BlockData(): 0x40...0x5f

UNSEALED Access: This data block is the remainder of the 32 byte data block when accessing data flash.

SEALED Access: This data block is the remainder of the 32 byte data block when accessing **Manufacturer Block Info A or B**.

4.1.2.5 BlockDataChecksum(): 0x60

UNSEALED Access: This byte contains the checksum on the 32 bytes of block data read or written to data flash. The least-significant byte of the sum of the data bytes written must be complemented ($[255 - x]$, for x the least-significant byte) before being written to 0x60.

SEALED Access: This byte contains the checksum for the 32 bytes of block data written to **Manufacturer Info Block A or B**. The least-significant byte of the sum of the data bytes written must be complemented ($[255 - x]$, for x the least-significant byte) before being written to 0x60.

4.1.2.6 BlockDataControl(): 0x61

UNSEALED Access: This command is used to control data flash access mode. Writing 0x00 to this command enables *BlockData()* to access general data flash. Writing a 0x01 to this command enables SEALED mode operation of *DataFlashBlock()*.

SEALED Access: This command is not available in SEALED mode.

4.1.2.7 *DeviceNameLength()*: 0x62

UNSEALED and SEALED Access: This byte contains the length of the *Device Name*.

4.1.2.8 *DeviceName()*: 0x63...0x69

UNSEALED and SEALED Access: This block contains the device name that is programmed in *Device Name*.

4.1.2.9 *ApplicationStatus()*: 0x6a

This byte function allows the system to read the bq27505-J4 *Application Status* data flash location. See [Table 6-1](#) for specific bit definitions.

4.1.2.10 Reserved — 0x6b–0x7f

4.2 DATA FLASH INTERFACE

4.2.1 ACCESSING THE DATA FLASH

The bq27505-J4 data flash is a non-volatile memory that contains bq27505-J4 initialization, default, cell status, calibration, configuration, and user information. The data flash can be accessed in several different ways, depending on what mode the bq27505-J4 is operating in and what data is being accessed.

Commonly accessed data flash memory locations, frequently read by a system, are conveniently accessed through specific instructions, already described in section [DATA COMMANDS](#). These commands are available when the bq27505-J4 is either in UNSEALED or SEALED modes.

Most data flash locations, however, are only accessible in UNSEALED mode by use of the bq27505-J4 evaluation software or by data flash block transfers. These locations should be optimized and/or fixed during the development and manufacture processes. They become part of a golden image file and can then be written to multiple battery packs. Once established, the values generally remain unchanged during end-equipment operation.

To access data flash locations individually, the block containing the desired data flash location(s) must be transferred to the command register locations, where they can be read to the system or changed directly. This is accomplished by sending the set-up command *BlockDataControl()* (0x61) with data 0x00. Up to 32 bytes of data can be read directly from the *BlockData()* (0x40...0x5f), externally altered, then rewritten to the *BlockData()* command space. Alternatively, specific locations can be read, altered, and rewritten if their corresponding offsets are used to index into the *BlockData()* command space. Finally, the data residing in the command space is transferred to data flash, once the correct checksum for the whole block is written to *BlockDataChecksum()* (0x60).

Occasionally, a data flash CLASS will be larger than the 32-byte block size. In this case, the *DataFlashBlock()* command is used to designate which 32-byte block the desired locations reside in. The correct command address is then given by $0x40 + \text{offset} \text{ modulo } 32$. For example, to access **Terminate Voltage** in the *Gas Gauging* class, *DataFlashClass()* is issued 80 (0x50) to set the class. Because the offset is 48, it must reside in the second 32-byte block. Hence, *DataFlashBlock()* is issued 0x01 to set the block offset, and the offset used to index into the *BlockData()* memory area is $0x40 + 48 \text{ modulo } 32 = 0x40 + 16 = 0x40 + 0x10 = 0x50$.

Reading and writing subclass data are block operations up to 32 bytes in length. If during a write the data length exceeds the maximum block size, then the data is ignored.

None of the data written to memory are bounded by the bq27505-J4 – the values are not rejected by the fuel gauge. Writing an incorrect value may result in hardware failure due to firmware program interpretation of the invalid data. The written data is persistent, so a power-on reset does resolve the fault.

4.3 MANUFACTURER INFORMATION BLOCKS

The bq27505-J4 contains two 32-bytes of user programmable data flash storage: **Manufacturer Info Block A**, and **Manufacturer Info Block B**. The method for accessing these memory locations is slightly different, depending on whether the device is in UNSEALED or SEALED modes.

When in UNSEALED mode and when 0x00 has been written to *BlockDataControl()*, accessing the manufacturer information blocks is identical to accessing general data flash locations. First, a *DataFlashClass()* command is used to set the subclass, then a *DataFlashBlock()* command sets the offset for the first data flash address within the subclass. The *BlockData()* command codes contain the referenced data flash data. When writing the data flash, a checksum is expected to be received by *BlockDataChecksum()*. Only when the checksum is received and verified is the data actually written to data flash.

As an example, the data flash location for **Manufacturer Info Block B** is defined as having a Subclass = 58 and an Offset = 32 through 63 (32 byte block). The specification of Class = System Data is not needed to address **Manufacturer Info Block B**, but is used instead for grouping purposes when viewing data flash info in the bq27505-J4 evaluation software.

When in SEALED mode or when 0x01 *BlockDataControl()* does not contain 0x00, data flash is no longer available in the manner used in UNSEALED mode. Rather than issuing subclass information, a designated Manufacturer Information Block is selected with the *DataFlashBlock()* command. Issuing a 0x01 or 0x02 with this command causes the corresponding information block (A or B, respectively) to be transferred to the command space 0x40...0x5f for editing or reading by the system. Upon successful writing of checksum information to *BlockDataChecksum()*, the modified block is returned to data flash.
Note: **Manufacturer Info Block A** is read-only when in SEALED mode.

4.4 ACCESS MODES

The bq27505-J4 provides three security modes (FULL ACCESS, UNSEALED, and SEALED) that control data flash access permissions, according to [Table 4-6](#). *Data Flash* refers to those data flash locations, specified in [Table 4-7](#), that are accessible to the user. *Manufacture Information* refers to the three 32-byte blocks.

Table 4-6. Data Flash Access

Security Mode	Data Flash	Manufacture Information
FULL ACCESS	R/W	R/W
UNSEALED	R/W	R/W
SEALED	None	R(A); R/W(B)

Although FULL ACCESS and UNSEALED modes appear identical, only FULL ACCESS allows the bq27505-J4 to write access-mode transition keys.

4.5 SEALING/UNSEALING DATA FLASH

The bq27505-J4 implements a key-access scheme to transition between SEALED, UNSEALED, and FULL-ACCESS modes. Each transition requires that a unique set of two keys be sent to the bq27505-J4 via the *Control()* control command. The keys must be sent consecutively, with no other data being written to the *Control()* register in between. Note that to avoid conflict, the keys must be different from the codes presented in the *CNTL DATA* column of [Table 4-2](#).

When in SEALED mode, the CONTROL_STATUS [SS] bit is set, but when the UNSEAL keys are correctly received by the bq27505-J4, the [SS] bit is cleared. When the full-access keys are correctly received, then the CONTROL_STATUS [FAS] bit is cleared.

Both the sets of keys for each level are 2 bytes each in length and are stored in data flash. The UNSEAL key (stored at **Unseal Key 0** and **Unseal Key 1**) and the FULL-ACCESS key (stored at **Full-Access Key 0** and **Full-Access Key 1**) can only be updated when in FULL-ACCESS mode. The order of the keys is **Key 1** followed by **Key 0**. The order of the bytes entered through the *Control()* command is the reverse of what is read from the part. For example, if the **Key 1** and **Key 0** of the **Unseal Keys** returns 0x1234 and 0x5678, then the *Control()* should supply 0x3412 and 0x7856 to unseal the part.

4.6 DATA FLASH SUMMARY

Table 4-7 summarizes the data flash locations available to the user, including their default, minimum, and maximum values.

Table 4-7. Data Flash Summary

Class	Subclass ID	Subclass	Offset	Name	Data Type	Min Value	Max Value	Default Value	Units
Configuration	2	Safety	0	OT Chg	I2	0	1200	550	0.1°C
Configuration	2	Safety	2	OT Chg Time	U1	0	60	2	s
Configuration	2	Safety	3	OT Chg Recovery	I2	0	1200	500	0.1°C
Configuration	2	Safety	5	OT Dsg	I2	0	1200	600	0.1°C
Configuration	2	Safety	7	OT Dsg Time	U1	0	60	2	s
Configuration	2	Safety	8	OT Dsg Recovery	I2	0	1200	550	0.1°C
Configuration	32	Charge Inhibit Temp Low	0	Charge Inhibit Temp Low	I2	-400	1200	0	0.1°C
Configuration	32	Charge Inhibit Temp High	2	Charge Inhibit Temp High	I2	-400	1200	450	0.1°C
Configuration	32	Temp Hysteresis	4	Temp Hys	I2	0	100	50	0.1°C
Configuration	34	Charge	2	Charging Voltage	I2	0	4600	4200	mV
Configuration	34	Charge	4	Delta Temp	I2	0	500	50	0.1°C
Configuration	34	Charge	6	Suspend Low Temp	I2	-400	1200	-50	0.1°C
Configuration	34	Charge	8	Suspend High Temp	I2	-400	1200	550	0.1°C
Configuration	36	Charge Termination	2	Taper Current	I2	0	1000	100	mA
Configuration	36	Charge Termination	4	Minimum Taper Charge	I2	0	1000	25	0.01mAh
Configuration	36	Charge Termination	6	Taper Voltage	I2	0	1000	100	mV
Configuration	36	Charge Termination	8	Current Taper Window	U1	0	60	40	s
Configuration	36	Charge Termination	11	FC Set %	I1	-1	100	100	%
Configuration	36	Charge Termination	12	FC Clear %	I1	-1	100	98	%
Configuration	48	Data	4	Initial Standby Current	I1	-256	0	-10	mA
Configuration	48	Data	5	Initial Max Load Current	I2	-32,767	0	-500	mA
Configuration	48	Data	7	CC Threshold	I2	100	32,767	900	mAh
Configuration	48	Data	10	Design Capacity	I2	0	65,535	1000	mAh
Configuration	48	Data	12	SOH Load	I2	-32,767	0	-400	mA
Configuration	48	Data	14	Default Temp	I2	0	1000	25 ⁽¹⁾	0.1°C
Configuration	48	Data	16	Device name	S8	x	x	bq27505-J4	-
Configuration	49	Discharge	0	SOC1 Set Threshold	U1	0	255	150	mAh
Configuration	49	Discharge	1	SOC1 Clear Threshold	U1	0	255	175	mAh
Configuration	49	Discharge	5	SysDown Set Volt Threshold	I2	0	4200	3150	mV
Configuration	49	Discharge	7	SysDown Set Volt Time	U1	0	60	2	s
Configuration	49	Discharge	8	SysDown Clear Volt Threshold	I2	0	4200	3400	mV
Configuration	49	Discharge	15	Final Voltage	U2	0	4200	3000	mV
Configuration	49	Discharge	17	Def Cell 0 DOD at EOC	I2	0	16384	0	Num
Configuration	49	Discharge	19	Def Cell 1 DOD at EOC	I2	0	16384	0	Num

(1) Display as the value EVSW displayed. Data Flash value is different.

Data Flash Summary (continued)

Class	Subclass ID	Subclass	Offset	Name	Data Type	Min Value	Max Value	Default Value	Units
Configuration	49	Discharge	21	Def Avg I Last Run	I2	-32768	32767	-299	mA
Configuration	49	Discharge	23	Def Avg P Last Run	I2	-32768	32767	-1131	mW
Configuration	56	Integrity Data	1	Full Reset Counter	U1	0	255	0	num
System Data	57	Manufacturer Info	0	Block A 0	H1	0x00	0xff	0x00	–
System Data	57	Manufacturer Info	1–31	Block A [10–31]	H1	0x00	0xff	0x00	–
System Data	57	Manufacturer Info	32–63	Block B [0–31]	H1	0x00	0xff	0x00	–
Configuration	64	Registers	0	Operation Configuration	H2	0x0000	0xffff	0x0973	–
Configuration	64	Registers	7	SOC Delta	U1	0	25	1	%
Configuration	64	Registers	8	I ² C Timeout	U1	0	7	4	num
Configuration	64	Registers	9	DFWrlndWaitTime	U2	0	65535	0	5μs
Configuration	64	Registers	11	OpConfigB	H1	0x00	0xff	0x40	Flags
Configuration	64	Registers	12	Debug Options	H1	4	0x00	0x04	Flags
Configuration	68	Power	0	Flash Update OK Voltage	I2	0	4200	2800	mV
Configuration	68	Power	7	Sleep Current	I2	0	100	10	mA
Configuration	68	Power	16	Hibernate Current	U2	0	700	8	mA
Configuration	68	Power	18	Hibernate Voltage	U2	2400	3000	2550	mV
Gas Gauging	80	IT Cfg	0	Load Select	U1	0	255	1	–
Gas Gauging	80	IT Cfg	1	Load Mode	U1	0	255	0	–
Gas Gauging	80	IT Cfg	21	Max Res Factor	U1	0	255	30	Num
Gas Gauging	80	IT Cfg	22	Min Res Factor	U1	0	255	3	Num
Gas Gauging	80	IT Cfg	24	Ra Filter	U2	0	1000	800	Num
Gas Gauging	80	IT Cfg	40	Min % Passed Charge for Qmax	U1	1	100	37	%
Gas Gauging	80	IT Cfg	44	Qmax Filter	U1	0	255	96	Num
Gas Gauging	80	IT Cfg	45	Terminate Voltage	I2	-32,768	32,767	3000	mV
Gas Gauging	80	IT Cfg	50	User Rate-mA	I2	-2000	-100	0	mA
Gas Gauging	80	IT Cfg	52	User Rate-mW	I2	-7200	-350	0	mW
Gas Gauging	80	IT Cfg	54	Reserve Cap-mAh	I2	0	9000	0	mAh
Gas Gauging	80	IT Cfg	56	Reserve Cap-mWh	I2	0	14,000	0	mWh
Gas Gauging	80	IT Cfg	61	Min Delta Voltage	I2	-32000	32000	0	mV
Gas Gauging	80	IT Cfg	63	Max Sim Rate	U1	0	255	2	C-rate
Gas Gauging	80	IT Cfg	64	Min Sim Rate	U1	0	255	20	C-rate
Gas Gauging	80	IT Cfg	65	Ra Max Delta	U2	0	65535	44	mOhms
Gas Gauging	80	IT Cfg	67	Qmax Max Delta	U1	0	65535	5	%
Gas Gauging	80	IT Cfg	68	DeltaV Max dV	U2	0	65535	10	mV
Gas Gauging	81	Current Thresholds	0	Dsg Current Threshold	I2	0	2000	60	mA
Gas Gauging	81	Current Thresholds	2	Chg Current Threshold	I2	0	2000	75	mA
Gas Gauging	81	Current Thresholds	4	Quit Current	I2	0	1000	40	mA
Gas Gauging	81	Current Thresholds	6	Dsg Relax Time	U2	0	8191	60	s
Gas Gauging	81	Current Thresholds	8	Chg Relax Time	U1	0	255	60	s
Gas Gauging	81	Current Thresholds	9	Quit Relax Time	U1	0	63	1	s
Gas Gauging	81	Current Thresholds	10	Max IR Correct	U2	0	1000	400	mV
Gas Gauging	82	State	0	IT Enable	H1	0x00	0x03	0x00	–
Gas Gauging	82	State	1	Application Status	H1	0x00	0xff	0x00	–
Gas Gauging	82	State	2	Qmax 0	I2	0	32,767	1000	mAh
Gas Gauging	82	State	4	Cycle Count 0	U2	0	65,535	0	–
Gas Gauging	82	State	6	Update Status 0	H1	0x00	0x03	0x00	–
Gas Gauging	82	State	7	Qmax 1	I2	0	32767	1000	mAh
Gas Gauging	82	State	9	Cycle Count 1	U2	0	65,535	0	Count
Gas Gauging	82	State	11	Update Status 1	H1	0x00	0x03	0x00	–
Gas Gauging	82	State	12	Cell0 Chg dod at EoC	I2	0	16384	0	–
Gas Gauging	82	State	14	Cell1 Chg dod at EoC	I2	0	16384	0	–
Gas Gauging	82	State	16	Avg I Last Run	I2	-32,768	32,767	-300	mA

Data Flash Summary (continued)

Class	Subclass ID	Subclass	Offset	Name	Data Type	Min Value	Max Value	Default Value	Units
Gas Gauging	82	State	18	Avg P Last Run	I2	–32,768	32,767	–1200	mAh
Gas Gauging	82	State	20	Delta Voltage	I2	–32,768	32,767	2	mV
Calibration	104	Data	0	CC Gain	F4 ⁽²⁾	0.1	47	10 ⁽¹⁾	mohm
Calibration	104	Data	4	CC Delta	F4 ⁽²⁾	4.7	188	10 ⁽¹⁾	mohm
Calibration	104	Data	8	CC Offset	I2	–2.4	2.4	–0.123 ⁽¹⁾	mV
Calibration	104	Data	10	ADC Offset	I2	–500	500	0	mV
Calibration	104	Data	12	Board Offset	I1	–128	127	0	mV
Calibration	104	Data	13	Int Temp Offset	I1	–128	127	0	0.1°C
Calibration	104	Data	14	Ext Temp Offset	I1	–128	127	0	0.1°C
Calibration	104	Data	15	Pack V Offset	I1	–128	127	0	mV
Calibration	107	Current	1	Deadband	U1	0	255	5	mA
Security	112	Codes	0	Unseal Key 0	H2	0x0000	0xffff	0x3672	–
Security	112	Codes	2	Unseal Key 1	H2	0x0000	0xffff	0x0414	–
Security	112	Codes	4	Full-Access Key 0	H2	0x0000	0xffff	0xffff	–
Security	112	Codes	6	Full-Access Key 1	H2	0x0000	0xffff	0xffff	–
Security	112	Codes	24	FactRestore Key	H4	0x00000000	0xffffffff	0x0FAC0DEF	–

(2) Not IEEE floating point.

5 FUNCTIONAL DESCRIPTION

5.1 FUEL GAUGING

The bq27505-J4 measures the cell voltage, temperature, and current to determine battery SOC. The bq27505-J4 monitors charge and discharge activity by sensing the voltage across a small-value resistor (5mΩ to 20mΩ typ.) between the SRP and SRN pins and in series with the cell. By integrating charge passing through the battery, the battery's SOC is adjusted during battery charge or discharge.

The total battery capacity is found by comparing states of charge before and after applying the load with the amount of charge passed. When an application load is applied, the impedance of the cell is measured by comparing the OCV obtained from a predefined function for present SOC with the measured voltage under load. Measurements of OCV and charge integration determine chemical state of charge and chemical capacity (Qmax). The initial Qmax values are taken from a cell manufacturers' data sheet multiplied by the number of parallel cells. It is also used for the value in **Design Capacity**. The bq27505-J4 acquires and updates the battery-impedance profile during normal battery usage. It uses this profile, along with SOC and the Qmax value, to determine *FullChargeCapacity()* and *StateOfCharge()*, specifically for the present load and temperature. *FullChargeCapacity()* is reported as capacity available from a fully charged battery under the present load and temperature until *Voltage()* reaches the **Term Voltage**. *NominalAvailableCapacity()* and *FullAvailableCapacity()* are the uncompensated (no or light load) versions of *RemainingCapacity()* and *FullChargeCapacity()* respectively.

The bq27505-J4 has two flags accessed by the *Flags()* function that warns when the battery's SOC has fallen to critical levels. When *RemainingCapacity()* falls below the first capacity threshold, specified in **SOC1 Set Threshold**, the *[SOC1]* (*State of Charge Initial*) flag is set. The flag is cleared once *RemainingCapacity()* rises above **SOC1 Set Threshold**. The bq27505-J4's BAT_LOW pin automatically reflects the status of the *[SOC1]* flag. All units are in mAh.

When *Voltage()* falls below the system shut down threshold voltage, **SysDown Set Volt Threshold**, the *[SYSDOWN]* flag is set, serving as a final warning to shut down the system. The SOC_INT also signals. When *Voltage()* rises above **SysDown Clear Voltage** and the *[SYSDOWN]* flag has already been set, the *[SYSDOWN]* flag is cleared. The SOC_INT also signals such change. All units are in mV.

5.2 IMPEDANCE TRACK™ VARIABLES

The bq27505-J4 has several data flash variables that permit the user to customize the Impedance Track™ algorithm for optimized performance. These variables are dependent upon the power characteristics of the application as well as the cell itself.

5.2.1 Load Mode

Load Mode is used to select either the constant-current or constant-power model for the Impedance Track™ algorithm as used in **Load Select** (see **Load Select**). When **Load Mode** is 0, the *Constant Current Model* is used (default). When 1, the *Constant Power Model* is used. The [LDMD] bit of CONTROL_STATUS reflects the status of **Load Mode**.

5.2.2 Load Select

Load Select defines the type of power or current model to be used to compute load-compensated capacity in the Impedance Track™ algorithm. If **Load Mode** = 0 (*Constant-Current*) then the options presented in [Table 5-1](#) are available.

Table 5-1. Constant-Current Model Used When Load Mode = 0

LoadSelect Value	Current Model Used
0	Average discharge current from previous cycle: There is an internal register that records the average discharge current through each entire discharge cycle. The previous average is stored in this register.
1(default)	Present average discharge current: This is the average discharge current from the beginning of this discharge cycle until present time.
2	Average current: based on AverageCurrent()
3	Current: based off of a low-pass-filtered version of AverageCurrent() ($\tau = 14$ s)
4	Design capacity / 5: C Rate based off of Design Capacity /5 or a C/5 rate in mA.
5	AtRate (mA): Use whatever current is in AtRate()
6	User_Rate-mA: Use the value in User_Rate() . This mode provides a completely user-configurable method.

If **Load Mode** = 1 (*Constant Power*) then the following options shown in [Table 5-2](#) are available:

Table 5-2. Constant-Power Model Used When Load Mode = 1

LoadSelect Value	Power Model Used
0(default)	Average discharge power from previous cycle: There is an internal register that records the average discharge power through each entire discharge cycle. The previous average is stored in this register.
1	Present average discharge power: This is the average discharge power from the beginning of this discharge cycle until present time.
2	Average current x voltage: based off the AverageCurrent() and Voltage() .
3	Current x voltage: based off of a low-pass-filtered version of AverageCurrent() ($\tau = 14$ s) and Voltage()
4	Design energy / 5: C Rate based off of Design Energy /5 or a C/5 rate in mA.
5	AtRate (10 mW): Use whatever value is in AtRate() .
6	User_Rate-10mW: Use the value in User_Rate() mW. This mode provides a completely user-configurable method.

5.2.3 Reserve Cap-mAh

Reserve Cap-mAh determines how much actual remaining capacity exists after reaching 0 **RemainingCapacity()**, before **Terminate Voltage** is reached. A no-load rate of compensation is applied to this reserve.

5.2.4 Reserve Cap-mWh

Reserve Cap-mWh determines how much actual remaining capacity exists after reaching 0 **AvailableEnergy()**, before **Terminate Voltage** is reached. A no-load rate of compensation is applied to this reserve capacity.

5.2.5 Dsg Current Threshold

This register is used as a threshold by many functions in the bq27505-J4 to determine if actual discharge current is flowing into or out of the cell. The default for this register is in [Table 4-7](#), which should be sufficient for most applications. This threshold should be set low enough to be below any normal application load current but high enough to prevent noise or drift from affecting the measurement.

5.2.6 Chg Current Threshold

This register is used as a threshold by many functions in the bq27505-J4 to determine if actual charge current is flowing into or out of the cell. The default for this register is in [Table 4-7](#), which should be sufficient for most applications. This threshold should be set low enough to be below any normal charge current but high enough to prevent noise or drift from affecting the measurement.

5.2.7 Quit Current, DSG Relax Time, CHG Relax Time, and Quit Relax Time

The **Quit Current** is used as part of the Impedance Track™ algorithm to determine when the bq27505-J4 enters relaxation mode from a current-flowing mode in either the charge direction or the discharge direction. The value of **Quit Current** is set to a default value in [Table 4-7](#) and should be above the standby current of the system.

Either of the following criteria must be met to enter relaxation mode:

- $|AverageCurrent()| < |Quit Current|$ for **Dsg Relax Time**
- $|AverageCurrent()| > |Quit Current|$ for **Chg Relax Time**

After about 5 minutes in relaxation mode, the bq27505-J4 attempts to take accurate OCV readings. An additional requirement of $dV/dt < 4 \mu V/s$ is required for the bq27505-J4 to perform Qmax updates. These updates are used in the Impedance Track™ algorithms. It is critical that the battery voltage be relaxed during OCV readings to and that the current is not be higher than C/20 when attempting to go into relaxation mode.

Quit Relax Time specifies the minimum time required for **AverageCurrent()** to remain above the **QuitCurrent** threshold before exiting relaxation mode.

5.2.8 Qmax 0 and Qmax 1

Generically called Qmax, these dynamic variables contain the respective maximum chemical capacity of the active cell profiles, and are determined by comparing states of charge before and after applying the load with the amount of charge passed. They also correspond to capacity at very low rate of discharge, such as C/20 rate. For high accuracy, this value is periodically updated by the bq27505-J4 during operation. Based on the battery cell capacity information, the initial value of chemical capacity should be entered in the **Qmax n** field for each default cell profile. The Impedance Track™ algorithm will update these values and maintain them the associated actual cell profiles.

5.2.9 Update Status 0 and Update Status 1

Bit 0 (0x01) of the **Update Status n** registers indicates that the bq27505-J4 has learned new Qmax parameters and is accurate. The remaining bits are reserved. Bits 0 is user-configurable; however, it is also a status flag that can be set by the bq27505-J4. Bit 0 should never be modified except when creating a golden image file as explained in the application note [Preparing Optimized Default Flash Constants for specific Battery Types \(SLUA334\)](#). Bit 0 is updated as needed by the bq27505-J4.

5.2.10 Avg I Last Run

The bq27505-J4 logs the current averaged from the beginning to the end of each discharge cycle. It stores this average current from the previous discharge cycle in this register. This register should never need to be modified. It is only updated by the bq27505-J4 when required.

5.2.11 Avg P Last Run

The bq27505-J4 logs the power averaged from the beginning to the end of each discharge cycle. It stores this average power from the previous discharge cycle in this register. To get a correct average power reading the bq27505-J4 continuously multiplies instantaneous current times *Voltage*() to get power. It then logs this data to derive the average power. This register should never need to be modified. It is only updated by the bq27505-J4 when required.

5.2.12 Delta Voltage

The bq27505-J4 stores the maximum difference of *Voltage*() during short load spikes and normal load, so the Impedance Track™ algorithm can calculate remaining capacity for pulsed loads. This behavior can be modified by setting bits 0 and 1 of the Data flash register **Debug Options** as follows:

Bit1	Bit0	Delta V Selection	Description
0	0	Standard	Average variance from steady state voltage used to determine end of discharge voltage
0	1	No Averaging	Last instantaneous change in voltage from steady state used to determine end of discharge voltage
1	0	Minimum Delta V	Value in Min Delta Voltage used
1	1	<i>unused</i>	

5.2.13 Default Ra and Ra Tables

These tables contain encoded data and, with the exception of the **Default Ra Tables**, are automatically updated during device operation. No user changes should be made except for reading/writing the values from a pre-learned pack (part of the process for creating golden image files).

5.3 DETAILED PIN DESCRIPTION

5.3.1 The Operation Configuration Register

Some bq27505-J4 pins are configured via the **Operation Configuration** data flash register, as indicated in [Table 5-3](#). This register is programmed/read via the methods described in [ACCESSING THE DATA FLASH](#). The register is located at subclass = 64, offset = 0.

Table 5-3. Operation Configuration Bit Definition

	bit7	bit6	bit5	bit4	bit3	bit2	bit1	bit0
High byte	RESCAP	BATG_OVR	INT_BREM	PFC_CFG1	PFC_CFG0	IWAKE	RSNS1	RSNS0
Low byte	INT_FOCV	IDSELEN	SLEEP	RMFCC	SOCI_POL	BATG_POL	BATL_POL	TEMPS

RESCAP = No-load rate of compensation is applied to the reserve capacity calculation. True when set. Default is 0.

BATG_OVR = BAT_GD override bit. If the gauge enters Hibernate only due to the cell voltage, the BAT_GD will not negate. True when set. Default is 0.

INT_BREM = Battery removal interrupt bit. The SOC_INT pulses 1ms when the battery removal interrupt is enabled. True when set. The default is 0.

PFC_CFG1/PFC_CFG0 = Pin function code (PFC) mode selection: PFC 0, 1, or 2 selected by 0/0, 0/1, or 1/0, respectively. Default is PFC 1 (0/1).

IWAKE/RSNS1/RSNS0 = These bits configure the current wake function (see [Table 5-6](#)). Default is 0/0/1.

INT_FOCV = Indication of the measurement of the OCV during the initialization. The SOC_INT will pulse during the first measurement if this bit is set. True when set. Default is 0.

IDSELEN = Enables cell profile selection feature. True when set. Default is 1.

SLEEP = The fuel gauge can enter sleep, if operating conditions allow. True when set. Default is 1.

RMFCC = RM is updated with the value from FCC, on valid charge termination. True when set. Default is 1.

SOCI_POL = SOC interrupt polarity is active-low. True when cleared. Default is 0.

BATG_POL = /BAT_GD pin is active-low. True when cleared. Default is 0.

BATL_POL = BAT_LOW pin is active-high. True when set. Default is 1.

TEMPS = Selects external thermistor for *Temperature()* measurements. True when set. Default is 1.

Some bq27505-J4 pins are configured via the **Operation Configuration B** data flash register, as indicated in [Table 5-4](#). This register is programmed/read via the methods described in [ACCESSING THE DATA FLASH](#). The register is located at subclass = 64, offset = 0.

Table 5-4. Operation Configuration B Bit Definition

bit7	bit6	bit5	bit4	bit3	bit2	bit1	bit0
WRTEMP	BIE	BL_INT	GNDSEL	BattGdlnit	DFWrIndBL	–	–

WRTEMP = Enables the temperature write. The temperature could be written by the host. True when set. Default is 0.

BIE = Battery insertion detection enable. True when set. Default is 1. When the battery insertion detection is disabled, the gauge relies on the host command to set the BAT_DET bit.

BL_INT = Battery low interrupt enable. True when set. Default is 0.

GNDSEL = The ADC ground select control. The Vss (Pin D1) is selected as ground reference when the bit is clear. Pin A1 is selected when the bit is set. Default is 1.

BattGdlnit = BAT_GD will be asserted during the initialization. It is for application that needs the system be powered up ASAP. True when set. Default is 0.

DFWrIndBL = DataFlash Write Indication. SOC_INT is used for indication if the bit is clear. BAT_LOW is used for indication if the bit is set. Default is 0.

5.3.2 Pin Function Code Descriptions

The bq27505-J4 has three possible pin-function variations that can be selected in accordance with the circuit architecture of the end application. Each variation has been assigned a pin function code, or PFC.

When the PFC is set to 0, only the bq27505-J4 measures battery temperature under discharge and relaxation conditions. The charger does not receive any information from the bq27505-J4 about the temperature readings, and therefore operates open-loop with respect to battery temperature.

A PFC of 1 is like a PFC of 0, except temperature is also monitored during battery charging. If charging temperature falls outside of the preset range defined in data flash, a charger can be disabled via the /BAT_GD pin until cell temperature recovers. See [Charge Inhibit](#), for additional details.

Finally when the PFC is set to 2, the battery thermistor can be shared between the fuel gauge and the charger. The charger has full usage of the thermistor during battery charging, while the fuel gauge uses the thermistor exclusively during discharge and battery relaxation.

The PFC is specified in **Operation Configuration [PFC_CFG1, PFC_CFG0]**. The default is PFC = 1.

5.3.3 BAT_LOW Pin

The BAT_LOW pin provides a system processor with an electrical indicator of battery status. The signaling on the BAT_LOW pin follows the status of the [SOC1] bit in the *Flags()* register. Note that the polarity of the BAT_LOW pin can be inverted via the [BATL_POL] bit of the **Operation Configuration**.

5.3.4 Power Path Control with the BAT_GD Pin

The bq27505-J4 must operate in conjunction with other electronics in a system appliance, such as chargers or other ICs and application circuits that draw appreciable power. After a battery is inserted into the system, there should be no charging current or a discharging current higher than C/20, so that an accurate OCV can be read. The OCV is used for helping determine which battery profile to use, as it constitutes part of the battery impedance measurement.

When a battery is inserted into a system, the Impedance Track™ algorithm requires that no charging of the battery takes place and that any discharge is limited to less than C/20—these conditions are sufficient for the fuel gauge to take an accurate OCV reading. To disable these functions, the /BAT_GD pin is merely negated from the default setting. Once an OCV reading has been made, the /BAT_GD pin is asserted, thereby enabling battery charging and regular discharge of the battery. The **Operation Configuration [BATG_POL]** bit can be used to set the polarity of the battery good signal, should the default configuration need to be changed.

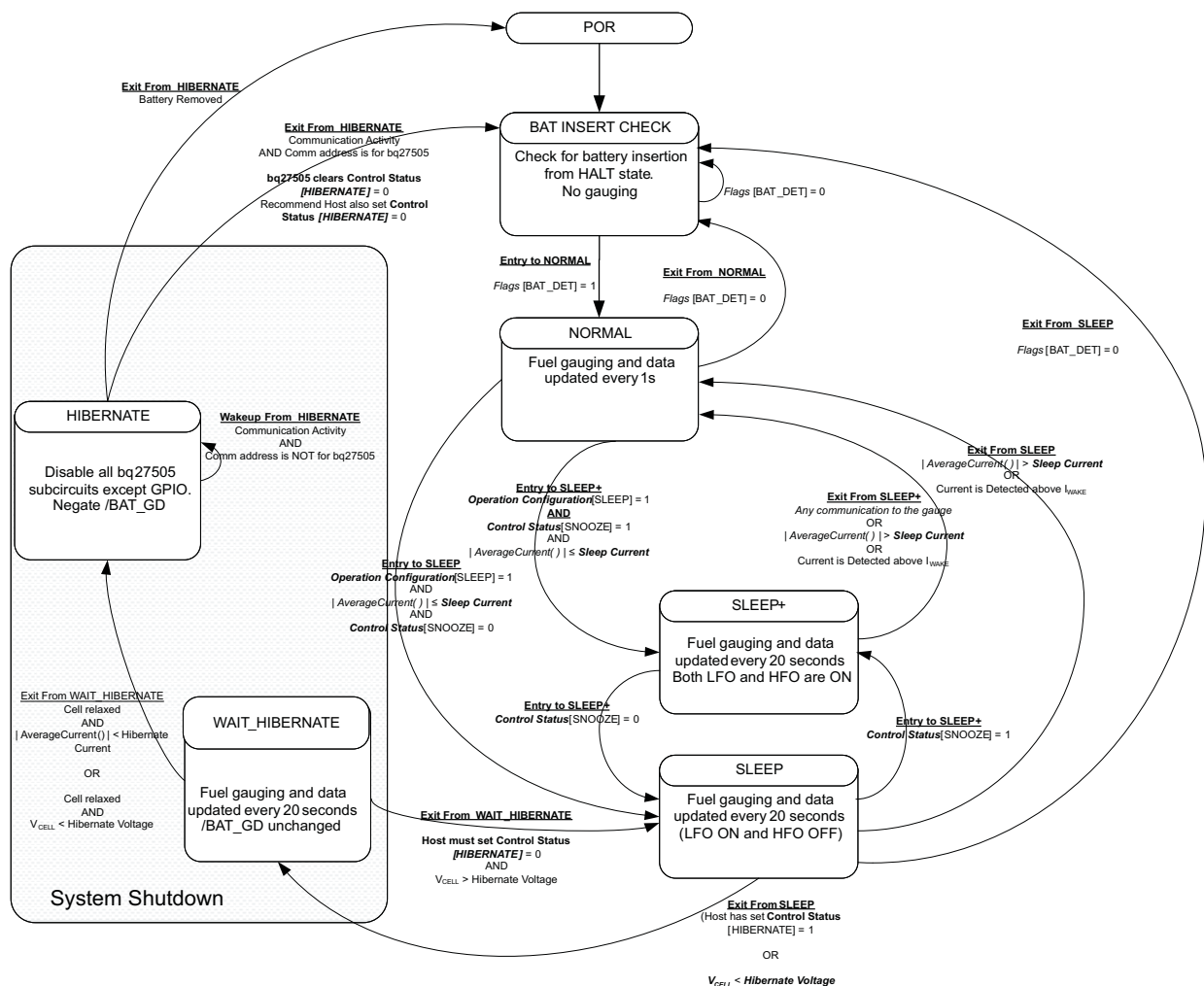

Figure 5-1. Power Mode Diagram

Figure 5-1 details how the /BAT_GD pin functions in the context of battery insertion and removal, as well as NORMAL vs. SLEEP modes.

In PFC 1, the /BAT_GD pin is also used to disable battery charging when the bq27505-J4 reads battery temperatures outside the range defined by [**Charge Inhibit Temp Low, Charge Inhibit Temp High**]. The /BAT_GD line is asserted once temperature falls within the range [**Charge Inhibit Temp Low + Temp Hys, Charge Inhibit Temp High – Temp Hys**].

5.3.5 Battery Detection Using the BI/TOUT Pin

During power-up or hibernate activities, or any other activity where the bq27505-J4 needs to determine whether a battery is connected or not, the fuel gauge applies a test for battery presence. First, the BI/TOUT pin is put into high-Z status. The weak 1.8MΩ pull-up resistor will keep the pin high while no battery is present. When a battery is inserted (or is already inserted) into the system device, the BI/TOUT pin will be pulled low. This state is detected by the fuel gauge, which polls this pin every second when the gauge has power. A *battery-disconnected* status is assumed when the bq27505-J4 reads a thermistor voltage that is near 2.5V.

5.3.6 SOC_INT pin

The SOC_INT pin generates a pulse with different pulse width under various conditions. Some features needs to be enabled by setting the Operation Config.

Table 5-5. Operation Configuratin B Blt Definition

	Enable Condition	Pulse Width	Comment
SOC_Delta Point	SOC_Delta ≠ 0	1 ms	During charge, when the SOC is greater than (\geq) the points, 100% + n × SOC_Delta and 100%; During discharge, when the SOC reaches ($<$) the points 100% + n × SOC_Delta and 0%; where n is an integer starting from 0 to the number generating SOC no less than 100%
SOC1 Set	Always	1 ms	When RSOC reached the SOC1 Set or Clear threshold set in the Data Flash
SOC1 Clear	Always	1 ms	
SysDown Set	Always	1 ms	When the Battery Voltage reached the SysDown Set or Clear threshold set in the Data Flash
SysDown Clear	Always	1 ms	
State Change	SOC_Delta ≠ 0	1 ms	When there is a state change including charging, discharging and relaxation.
Battery Removal	INT_BREM bit is set in OpConfig	1ms	—
OCV Command	After Initialization	Same as the OCV command execution time period	SOC_INT pulses for the OCV command after the initialization.
OCV Command	INT_FOCV bit is set in OpConfig	Same as the OCV command execution time period	This command is to generate the SOC_INT pulse during the initialization.
Data Flash Write	After Initialization AND DFWrIndWaitTime ≠ 0	Programmable time plus flash erase and write time	SOC_INT is used to indicate the data flash update. The gauge will wait DFWrIndWaitTime times 5μs after the SOC_INT signal to start the data flash update. This function is disabled if DFWrIndWaitTime is set to 0.
Factory Restore	Always	Time for restore function to complete	Asserted while dataflash learned Ra tables and Qmax are overwritten with defaults.

5.4 TEMPERATURE MEASUREMENT

The bq27505-J4 measures battery temperature via its TS input, in order to supply battery temperature status information to the fuel gauging algorithm and charger-control sections of the gauge. Alternatively, it can also measure internal temperature via its on-chip temperature sensor, but only if the [**TEMPS**] bit of **Operation Configuration** register is cleared.

Regardless of which sensor is used for measurement, a system processor can request the current battery temperature by calling the *Temperature()* function (see [STANDARD DATA COMMANDS](#), for specific information).

The recommended thermistor circuit uses an external 103AT-type thermistor. Additional circuit information for connecting this thermistor to the bq27505-J4 is shown in [REFERENCE SCHEMATIC](#).

5.5 OVERTEMPERATURE INDICATION

5.5.1 *Overtemperature: Charge*

If during charging, *Temperature()* reaches the threshold of **OT Chg** for a period of **OT Chg Time** and *AverageCurrent()* > **Chg Current Threshold**, then the [OTC] bit of *Flags()* is set. When *Temperature()* falls to **OT Chg Recovery**, the [OTC] of *Flags()* is reset.

If **OT Chg Time** = 0, then the feature is completely disabled.

5.5.2 *Overtemperature: Discharge*

If during discharging, *Temperature()* reaches the threshold of **OT Dsg** for a period of **OT Dsg Time**, and *AverageCurrent()* ≤ **-Dsg Current Threshold**, then the [OTD] bit of *Flags()* is set. When *Temperature()* falls to **OT Chg Recovery**, the [OTC] bit of *Flags()* is reset.

If **OT Dsg Time** = 0, then feature is completely disabled.

5.6 CHARGING AND CHARGE-TERMINATION INDICATION

5.6.1 *Detecting Charge Termination*

For proper bq27505-J4 operation, the cell charging voltage must be specified by the user. The default value for this variable is **Charging Voltage** in [Table 4-7](#).

The bq27505-J4 detects charge termination when (1) during 2 consecutive periods of **Current Taper Window**, the *AverageCurrent()* is < **Taper Current**, (2) during the same periods, the accumulated change in capacity > 0.25mAh / **Current Taper Window**, and (3) *Voltage()* > **Charging Voltage – Taper Voltage**. When this occurs, the [CHG] bit of *Flags()* is cleared. Also, if the [RMFCC] bit of **Operation Configuration** is set, and *RemainingCapacity()* is set equal to *FullChargeCapacity()*.

5.6.2 *Charge Inhibit*

When PFC = 1, the bq27505-J4 can indicate when battery temperature has fallen below or risen above predefined thresholds **Charge Inhibit Temp Low** and **Charge Inhibit Temp High**, respectively. In this mode, the /BAT_GD line is made *high* to indicate this condition, and is returned to its *low* state, once battery temperature returns to the range [**Charge Inhibit Temp Low + Temp Hys, Charge Inhibit Temp High – Temp Hys**].

When PFC = 0 or 2, the bq27505-J4 must be queried by the system in order to determine the battery temperature. At that time, the bq27505-J4 will sample the temperature. This saves battery energy when operating from battery, as periodic temperature updates are avoided during charging mode.

5.7 POWER MODES

The bq27505-J4 has different power modes: BAT INSERT CHECK, NORMAL, SLEEP, SLEEP+ and HIBERNATE. In NORMAL mode, the bq27505-J4 is fully powered and can execute any allowable task. In SLEEP+ mode, both low frequency and high frequency oscillators are active. Although the SLEEP+ has higher current consumption than the SLEEP mode, it is also a reduced power mode. In SLEEP mode, the

fuel gauge turns off the high frequency oscillator and exists in a reduced-power state, periodically taking measurements and performing calculations. In HIBERNATE mode, the fuel gauge is in a very low power state, but can be woken up by communication or certain I/O activity. Finally, the BAT INSERT CHECK mode is a powered-up, but low-power halted, state, where the bq27505-J4 resides when no battery is inserted into the system.

The relationship between these modes is shown in [Figure 5-1](#).

5.7.1 BAT INSERT CHECK MODE

This mode is a halted-CPU state that occurs when an adapter, or other power source, is present to power the bq27505-J4 (and system), yet no battery has been detected. When battery insertion is detected, a series of initialization activities begin, which include: OCV measurement, setting the BAT_GD pin, and selecting the appropriate battery profiles.

Some commands, issued by a system processor, can be processed while the bq27505-J4 is halted in this mode. The gauge will wake up to process the command, then return to the halted state awaiting battery insertion.

5.7.2 NORMAL MODE

The fuel gauge is in NORMAL mode when not in any other power mode. During this mode, *AverageCurrent()*, *Voltage()* and *Temperature()* measurements are taken, and the interface data set is updated. Decisions to change states are also made. This mode is exited by activating a different power mode.

Because the gauge consumes the most power in NORMAL mode, the Impedance Track™ algorithm minimizes the time the fuel gauge remains in this mode.

5.7.3 SLEEP MODE

SLEEP mode is entered automatically if the feature is enabled (**Operation Configuration [SLEEP] = 1**) and *AverageCurrent()* is below the programmable level **Sleep Current**. Once entry into SLEEP mode has been qualified, but prior to entering it, the bq27505-J4 performs an coulomb counter autocalibration to minimize offset.

During SLEEP mode, the bq27505-J4 periodically takes data measurements and updates its data set. However, a majority of its time is spent in an idle condition.

The bq27505-J4 exits SLEEP if any entry condition is broken, specifically when (1) *AverageCurrent()* rises above **Sleep Current**, or (2) a current in excess of I_{WAKE} through R_{SENSE} is detected.

In the event that a battery is removed from the system while a charger is present (and powering the gauge), Impedance Track™ updates are not necessary. Hence, the fuel gauge enters a state that checks for battery insertion and does not continue executing the Impedance Track™ algorithm.

5.7.4 SLEEP+ MODE

Compared to the SLEEP mode, SLEEP+ mode has the high frequency oscillator in operation. The communication delay could be eliminated. The SLEEP+ is entered automatically if the feature is enabled (**CONTROL STATUS [SNOOZE] = 1**) and *AverageCurrent()* is below the programmable level **Sleep Current**.

During SLEEP+ mode, the bq27505-J4 periodically takes data measurements and updates its data set. However, a majority of its time is spent in an idle condition.

The bq27505-J4 exits SLEEP+ if any entry condition is broken, specifically when (1) any communication activity with the gauge, or (2) *AverageCurrent()* rises above **Sleep Current**, or (3) a current in excess of I_{WAKE} through R_{SENSE} is detected.

5.7.5 HIBERNATE MODE

HIBERNATE mode should be used when the system equipment needs to enter a low-power state, and minimal gauge power consumption is required. This mode is ideal when a system equipment is set to its own HIBERNATE, SHUTDOWN, or OFF modes.

Before the fuel gauge can enter HIBERNATE mode, the system must set the *[HIBERNATE]* bit of the CONTROL_STATUS register. The gauge waits to enter HIBERNATE mode until it has taken a valid OCV measurement and the magnitude of the average cell current has fallen below **Hibernate Current**. The gauge can also enter HIBERNATE mode if the cell voltage falls below **Hibernate Voltage** and a valid OCV measurement has been taken. The gauge will remain in HIBERNATE mode until the system issues a direct I²C command to the gauge or a POR occurs. I²C Communication that is not directed to the gauge will not wake the gauge (or at least for very long).

It is important that /BAT_GD be set to *disable* status (no battery charging/discharging). This prevents a charger application from inadvertently charging the battery before an OCV reading can be taken. It is the system's responsibility to wake the bq27505-J4 after it has gone into HIBERNATE mode. After waking, the gauge can proceed with the initialization of the battery information (OCV, profile selection, etc.)

5.8 POWER CONTROL

5.8.1 Reset Functions

When the bq27505-J4 detects a software reset ([RESET] bit of Control() initiated), it increments the reset counter.

5.8.2 WAKE-UP COMPARATOR

The wake up comparator is used to indicate a change in cell current while the bq27505-J4 is SLEEP or HIBERNATE modes. **Operation Configuration** uses bits *[RSNS1–RSNS0]* to set the sense resistor selection. **Operation Configuration** also uses the *[IWAKE]* bit to select one of two possible voltage threshold ranges for the given sense resistor selection. An internal interrupt is generated when the threshold is breached in either the charge or discharge direction. Setting both *[RSNS1]* and *[RSNS0]* to 0 disables this feature.

Table 5-6. I_{WAKE} Threshold Settings⁽¹⁾

RSNS1	RSNS0	IWAKE	V _{th} (SRP–SRN)
0	0	0	Disabled
0	0	1	Disabled
0	1	0	+1.25 mV or –1.25 mV
0	1	1	+2.5 mV or –2.5 mV
1	0	0	+2.5 mV or –2.5 mV
1	0	1	+5 mV or –5 mV
1	1	0	+5 mV or –5 mV
1	1	1	+10 mV or –10 mV

(1) The actual resistance value vs the setting of the sense resistor is not important, just the actual voltage threshold when calculating the configuration.

5.8.3 FLASH UPDATES

Data Flash can only be updated if *Voltage()* ≥ **Flash Update OK Voltage**. Flash programming current can cause an increase in LDO dropout. The value of **Flash Update OK Voltage** should be selected such that the bq27505-J4 V_{CC} voltage does not fall below its minimum of 2.4 V during Flash write operations.

5.9 AUTOCALIBRATION

The bq27505-J4 provides an autocalibration feature that measures the voltage offset error across SRP and SRN as operating conditions change. It subtracts the resulting offset error from normal sense resistor voltage, V_{SR} , for maximum measurement accuracy.

Autocalibration of the coulomb counter begins on entry to SLEEP mode, except if $Temperature() \leq 5^{\circ}\text{C}$ or $Temperature() \geq 45^{\circ}\text{C}$.

The fuel gauge also performs a single offset when (1) the condition of $AverageCurrent() \leq 100 \text{ mA}$ and (2) {voltage change since last offset calibration $\geq 256 \text{ mV}$ } or {temperature change since last offset calibration is greater than 80°C for $\geq 60\text{s}$ }.

Capacity and current measurements continue at the last measured rate during the offset calibration when these measurements cannot be performed. If the battery voltage drops more than 32mV during the offset calibration, the load current has likely increased; hence, the offset calibration is aborted.

6 APPLICATION-SPECIFIC INFORMATION

6.1 BATTERY PROFILE STORAGE AND SELECTION

6.1.1 Common Profile Aspects

When a battery pack is removed from system equipment that implements the bq27505, the fuel gauge will maintain some of the battery information, if it is re-inserted. This way the Impedance Track™ algorithm will often have a means of recovering battery-status information; thereby, maintaining good state-of-charge (SOC) estimates.

Two default battery profiles are available to store battery information. They are used to provide the Impedance Track™ algorithm with the default information on two possible battery types expected to be used with the end-equipment. These default profiles can be used to support batteries of different chemistry, same chemistry but different capacities, or same chemistry but different models. Default profiles are programmed by the end-equipment manufacturer. Only one of the default profiles can be selected, and this selection cannot be changed during end-equipment operation.

In addition to the default profiles, the bq27505-J4 maintains two abbreviated profiles: *Cell0* and *Cell1*. These tables hold *dynamic* battery data, and keep track of the status for up to two of the most recent batteries used. In most cases the bq27505-J4 can administrate information on two removable battery packs.

6.1.2 Activities Upon Pack Insertion

6.1.2.1 First OCV and Impedance Measurement

At power-up the /BAT_GD pin is inactive, so that the system might not obtain power from the battery (this depends on actual implementation). In this state, the battery should be put in a condition with load current less than $C/20$. Next, the bq27505-J4 measures its first open-circuit voltage (OCV) via the BAT pin. The *[OCVMDCOMP]* bit will set once the OCV measurement is completed. Depending on the load current, the *[OCVFAIL]* bit indicates whether the OCV reading is valid. From the OCV(SOC) table, the SOC of the inserted battery is found. Then the /BAT_GD pin is made active, and the impedance of the inserted battery is calculated from the measured voltage and the load current: $Z(\text{SOC}) = (OCV(\text{SOC}) - V) / I$. This impedance is compared with the impedance of the dynamic profiles, *Packn*, and the default profiles, *Defn*, for the same SOC (the letter *n* depicts either a **0** or **1**). The *[INITCOMP]* bit will be set afterwards and the OCV command could be issued.

6.1.3 Reading Application Status

The **Application Status** data flash location contains cell profile status information, and can be read using the `ApplicationStatus()` extended command (0x6a). The bit configuration of this function/location is shown in [Table 6-1](#).

Table 6-1. ApplicationStatus() Bit Definitions

Application Configuration	bit7	bit6	bit5	bit4	bit3	bit2	bit1	bit0
Byte	—	—	—	—	—	—	—	LU_PROF

LU_PROF = Last profile used by fuel gauge. *Cell0* last used when cleared. *Cell1* last used when set. Default is 0.

6.2 APPLICATION-SPECIFIC FLOW AND CONTROL

The bq27505-J4 supports only one type of battery profile. This profile is stored in both the **Def0** and **Def1** profiles. When a battery pack is inserted for the first time, the default profile is copied into the **Packn** profiles. Then the Impedance Track™ algorithm begins gas gauging, regularly updating **Packn** as the battery is used.

When an existing pack is removed from the bq27505-J4 and a different (or same) pack is inserted, cell impedance is measured immediately after battery detection (see section [First OCV and Impedance Measurement](#)). The bq27505-J4 chooses the profile which is closest to the measured impedance, starting with the **Pack n** profiles. That is, if the measured impedance matches **Pack 0**, then the **Pack 0** profile is used. If the measured impedance matches **Pack 1**, then the **Pack 1** profile is used. If the measured impedance does not match the impedance stored in either **Pack 0** or **Pack 1**, the battery pack is deemed new (none of the previously used packs). Either **Def0/Def1** profile is copied into either the **Pack 0** or **Pack 1** profile, overwriting the oldest **Pack n** profile.

7 COMMUNICATIONS

7.1 I²C INTERFACE

The bq27505-J4 supports the standard I²C read, incremental read, quick read, one byte write, and incremental write functions. The 7 bit device address (ADDR) is the most significant 7 bits of the hex address and is fixed as 1010101. The 8-bit device address will; therefore, be 0xAA or 0xAB for write or read, respectively.

Host generated bq27505 generated



(a) 1-byte write

(b) quick read

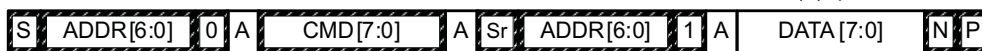

(c) 1- byte read

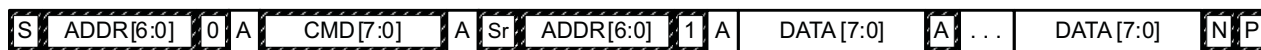

(d) incremental read



(e) incremental write

(S = Start, Sr = Repeated Start, A = Acknowledge, N = No Acknowledge, and P = Stop).

The “quick read” returns data at the address indicated by the address pointer. The address pointer, a register internal to the I²C communication engine, will increment whenever data is acknowledged by the bq27505-J4 or the I²C master. “Quick writes” function in the same manner and are a convenient means of sending multiple bytes to consecutive command locations (such as two-byte commands that require two bytes of data).

The following command sequences are not supported:

Attempt to write a read-only address (NACK after data sent by master):

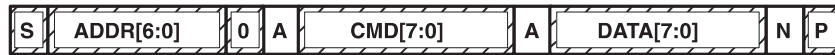

Attempt to read an address above 0x6B (NACK command):



7.2 I²C Time Out

The I²C engine will release both SDA and SCL if the I2C bus is held low for about 2 seconds. If the bq27505-J4 was holding the lines, releasing them will free for the master to drive the lines. If an external condition is holding either of the lines low, the I²C engine will enter the low power sleep mode.

To make sure the correct results of a command with the 400kHz I²C operation, a proper waiting time should be added between issuing command and reading results. For subcommands, the following diagram shows the waiting time required between issuing the control command the reading the status with the exception of checksum and OCV commands. A 100ms waiting time is required between the checksum command and reading result, and a 1.2 second waiting time is required between the OCV command and result. For read-write standard command, a minimum of 2 seconds is required to get the result updated. For read-only standard commands, there is no waiting time required, but the host should not issue all standard commands more than two times per second. Otherwise, the gauge could result in a reset issue due to the expiration of the watchdog timer.

The I²C clock stretch could happen in a typical application. A maximum 80ms clock stretch could be observed during the flash updates. There is up to 270ms clock stretch after the OCV command is issued.

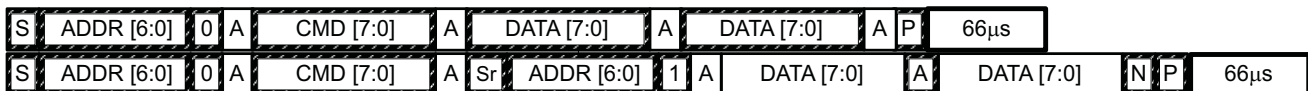

Waiting time between control subcommand and reading results

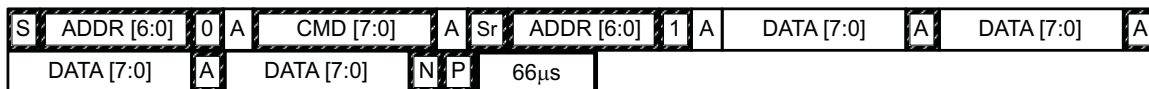

Waiting time between continuous reading results

PACKAGING INFORMATION

Orderable Device	Status (1)	Package Type	Package Drawing	Pins	Package Qty	Eco Plan (2)	Lead/Ball Finish	MSL Peak Temp (3)	Op Temp (°C)	Top-Side Markings (4)	Samples
BQ27505YZGR-J4	NRND	DSBGA	YZG	12	3000	Green (RoHS & no Sb/Br)	SNAGCU	Level-1-260C-UNLIM	-40 to 85	BQ27505	
BQ27505YZGT-J4	NRND	DSBGA	YZG	12	250	Green (RoHS & no Sb/Br)	SNAGCU	Level-1-260C-UNLIM	-40 to 85	BQ27505	

(1) The marketing status values are defined as follows:

ACTIVE: Product device recommended for new designs.

LIFEBUY: TI has announced that the device will be discontinued, and a lifetime-buy period is in effect.

NRND: Not recommended for new designs. Device is in production to support existing customers, but TI does not recommend using this part in a new design.

PREVIEW: Device has been announced but is not in production. Samples may or may not be available.

OBSOLETE: TI has discontinued the production of the device.

(2) Eco Plan - The planned eco-friendly classification: Pb-Free (RoHS), Pb-Free (RoHS Exempt), or Green (RoHS & no Sb/Br) - please check <http://www.ti.com/productcontent> for the latest availability information and additional product content details.

TBD: The Pb-Free/Green conversion plan has not been defined.

Pb-Free (RoHS): TI's terms "Lead-Free" or "Pb-Free" mean semiconductor products that are compatible with the current RoHS requirements for all 6 substances, including the requirement that lead not exceed 0.1% by weight in homogeneous materials. Where designed to be soldered at high temperatures, TI Pb-Free products are suitable for use in specified lead-free processes.

Pb-Free (RoHS Exempt): This component has a RoHS exemption for either 1) lead-based flip-chip solder bumps used between the die and package, or 2) lead-based die adhesive used between the die and leadframe. The component is otherwise considered Pb-Free (RoHS compatible) as defined above.

Green (RoHS & no Sb/Br): TI defines "Green" to mean Pb-Free (RoHS compatible), and free of Bromine (Br) and Antimony (Sb) based flame retardants (Br or Sb do not exceed 0.1% by weight in homogeneous material)

(3) MSL, Peak Temp. -- The Moisture Sensitivity Level rating according to the JEDEC industry standard classifications, and peak solder temperature.

(4) Multiple Top-Side Markings will be inside parentheses. Only one Top-Side Marking contained in parentheses and separated by a "~" will appear on a device. If a line is indented then it is a continuation of the previous line and the two combined represent the entire Top-Side Marking for that device.

Important Information and Disclaimer: The information provided on this page represents TI's knowledge and belief as of the date that it is provided. TI bases its knowledge and belief on information provided by third parties, and makes no representation or warranty as to the accuracy of such information. Efforts are underway to better integrate information from third parties. TI has taken and continues to take reasonable steps to provide representative and accurate information but may not have conducted destructive testing or chemical analysis on incoming materials and chemicals. TI and TI suppliers consider certain information to be proprietary, and thus CAS numbers and other limited information may not be available for release.

In no event shall TI's liability arising out of such information exceed the total purchase price of the TI part(s) at issue in this document sold by TI to Customer on an annual basis.

TAPE AND REEL INFORMATION

QUADRANT ASSIGNMENTS FOR PIN 1 ORIENTATION IN TAPE

*All dimensions are nominal

Device	Package Type	Package Drawing	Pins	SPQ	Reel Diameter (mm)	Reel Width W1 (mm)	A0 (mm)	B0 (mm)	K0 (mm)	P1 (mm)	W (mm)	Pin1 Quadrant
BQ27505YZGR-J4	DSBGA	YZG	12	3000	180.0	8.4	2.1	2.57	0.81	4.0	8.0	Q1
BQ27505YZGT-J4	DSBGA	YZG	12	250	180.0	8.4	2.1	2.57	0.81	4.0	8.0	Q1

TAPE AND REEL BOX DIMENSIONS

*All dimensions are nominal

Device	Package Type	Package Drawing	Pins	SPQ	Length (mm)	Width (mm)	Height (mm)
BQ27505YZGR-J4	DSBGA	YZG	12	3000	182.0	182.0	20.0
BQ27505YZGT-J4	DSBGA	YZG	12	250	182.0	182.0	20.0

YZG (R-XBGA-N12)

DIE-SIZE BALL GRID ARRAY

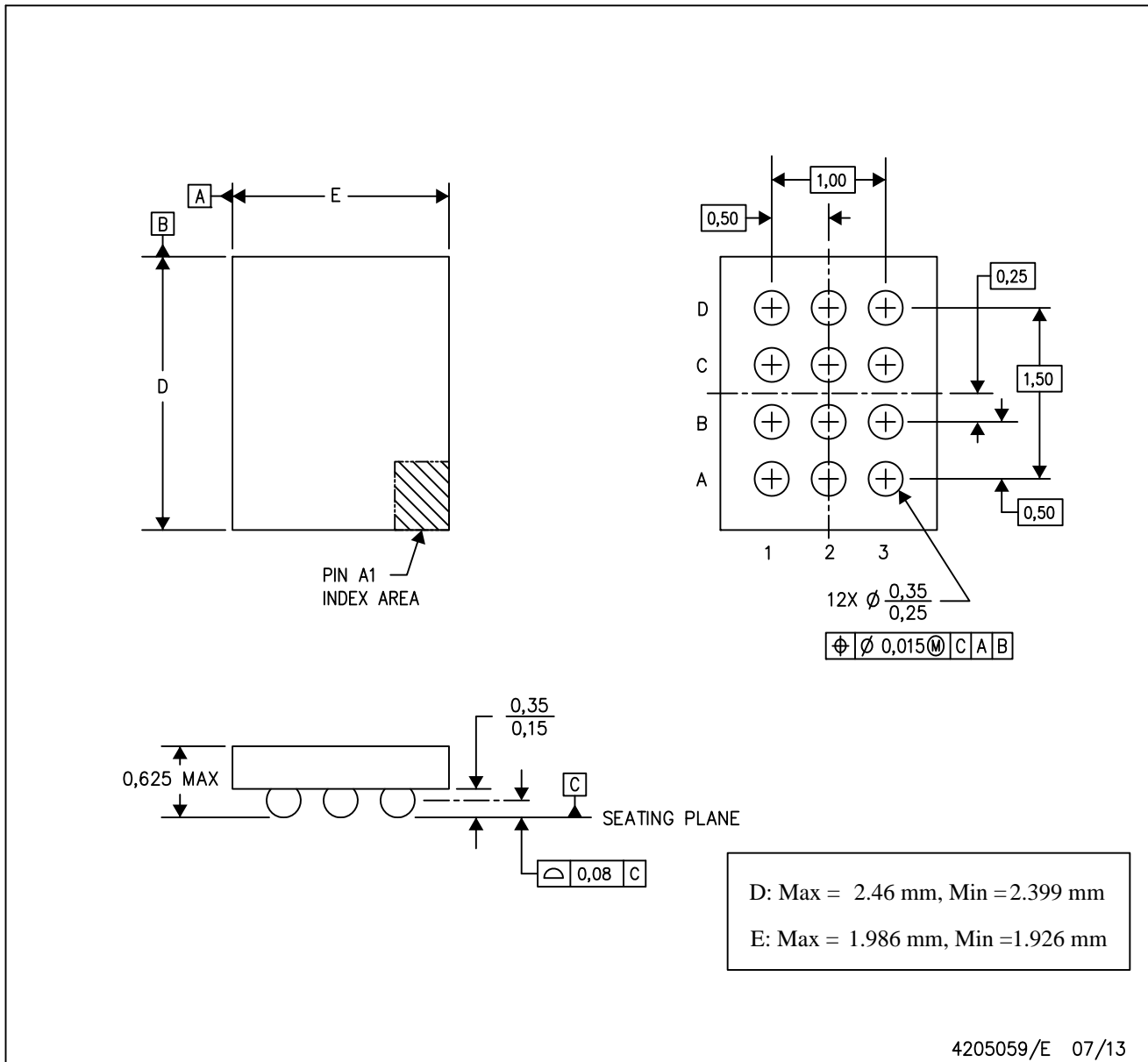

- NOTES: A. All linear dimensions are in millimeters. Dimensioning and tolerancing per ASME Y14.5M-1994.
 B. This drawing is subject to change without notice.
 C. NanoFree™ package configuration.

IMPORTANT NOTICE AND DISCLAIMER

TI PROVIDES TECHNICAL AND RELIABILITY DATA (INCLUDING DATASHEETS), DESIGN RESOURCES (INCLUDING REFERENCE DESIGNS), APPLICATION OR OTHER DESIGN ADVICE, WEB TOOLS, SAFETY INFORMATION, AND OTHER RESOURCES "AS IS" AND WITH ALL FAULTS, AND DISCLAIMS ALL WARRANTIES, EXPRESS AND IMPLIED, INCLUDING WITHOUT LIMITATION ANY IMPLIED WARRANTIES OF MERCHANTABILITY, FITNESS FOR A PARTICULAR PURPOSE OR NON-INFRINGEMENT OF THIRD PARTY INTELLECTUAL PROPERTY RIGHTS.

These resources are intended for skilled developers designing with TI products. You are solely responsible for (1) selecting the appropriate TI products for your application, (2) designing, validating and testing your application, and (3) ensuring your application meets applicable standards, and any other safety, security, or other requirements. These resources are subject to change without notice. TI grants you permission to use these resources only for development of an application that uses the TI products described in the resource. Other reproduction and display of these resources is prohibited. No license is granted to any other TI intellectual property right or to any third party intellectual property right. TI disclaims responsibility for, and you will fully indemnify TI and its representatives against, any claims, damages, costs, losses, and liabilities arising out of your use of these resources.

TI's products are provided subject to TI's Terms of Sale (www.ti.com/legal/termsofsale.html) or other applicable terms available either on ti.com or provided in conjunction with such TI products. TI's provision of these resources does not expand or otherwise alter TI's applicable warranties or warranty disclaimers for TI products.

Mailing Address: Texas Instruments, Post Office Box 655303, Dallas, Texas 75265
Copyright © 2019, Texas Instruments Incorporated

Looking for pricing, stock, or lifecycle information?

Click below to explore more details on WIN SOURCE:

 [View BQ27505YZGT-J4 on WIN SOURCE](#)

 [Texas Instruments](#) Information

Optimize Your Supply Chain with WIN SOURCE Solutions

-  Global Sourcing Solution
-  Obsolete Management
-  Cost Control Management
-  Shortage Management
-  Alternative Solution
-  Excess Inventory Management