



**THE DATASHEET OF
ATF22V10CQZ-20JU**



Features

- Industry-standard Architecture
- 12ns Maximum Pin-to-pin Delay
- Zero Power – 100µA Maximum Standby Power (Input Transition Detection)
- CMOS and TTL Compatible Inputs and Outputs
- Advanced Electrically Erasable Technology
 - Reprogrammable
 - 100% Tested
- Latch Feature Holds Inputs to Previous Logic State
- High-reliability CMOS Process
 - 20 Year Data Retention
 - 100 Erase/Write Cycles
 - 2,000V ESD Protection
 - 200mA Latchup Immunity
- Industrial Temperature Ranges
- Dual-in-line and Surface Mount Standard Pinouts
- PCI Compliant
- Green Package Options (Pb/Halide-free/RoHS Compliant) Available

1. Description

The Atmel® ATF22V10CZ/CQZ is a high-performance CMOS (electrically erasable) programmable logic device (PLD) which utilizes The Atmel proven electrically erasable Flash memory technology. Speeds down to 12ns with zero standby power dissipation are offered. All speed ranges are specified over the full 5V ±10% range for industrial temperature ranges; 5V ±5% for commercial range 5-volt devices. The ATF22V10CZ/CQZ provides a low voltage and edge-sensing “zero” power CMOS PLD solution with “zero” standby power (5µA typical). The ATF22V10CZ/CQZ provides a “zero” power CMOS PLD solution with 5V operating voltages, powering down automatically to the zero power-mode through The Atmel patented Input Transition Detection (ITD) circuitry when the device is idle, offering “zero” (100µA worst case) standby power. This feature allows the user to manage total system power to meet specific application requirements and enhance reliability. Pin “keeper” circuits on input and output pins eliminate static power consumed by pull-up resistors. The “CQZ” combines the low high-frequency I_{CC} of the “Q” design with the “Z” feature.

The ATF22V10CZ/CQZ incorporates a superset of the generic architectures, which allows direct replacement of the 22V10 family and most 24-pin combinatorial PLDs. Ten outputs are each allocated 8 to 16 product terms. Three different modes of operation, configured automatically with software, allow highly complex logic functions to be realized.



**High-performance
Electrically
Erasable
Programmable
Logic Device**

**Atmel ATF22V10CZ
Atmel ATF22V10CQZ**

**ATF22V10CZ is
Not Recommended for New
Design. Replaced by
ATF22V10CQZ.**



Figure 1-1. Block Diagram

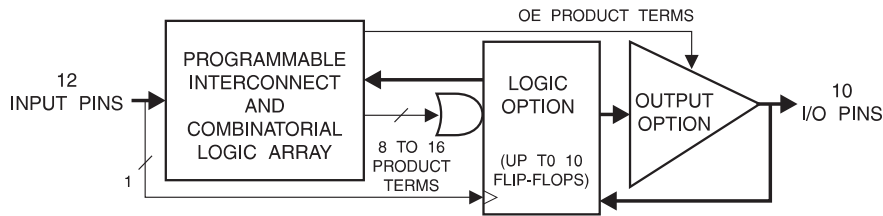

2. Pin Configurations

Table 2-1. Pin Configurations (All Pinouts Top View)

Pin Name	Function
CLK	Clock
IN	Logic Inputs
I/O	Bi-directional Buffers
VCC	+5V Supply

Figure 2-1. TSSOP

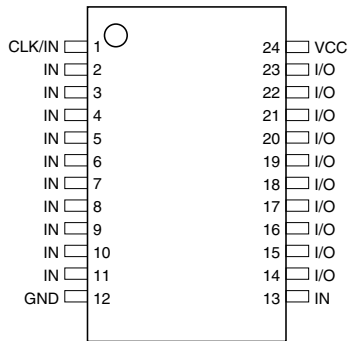

Figure 2-2. DIP/SOIC

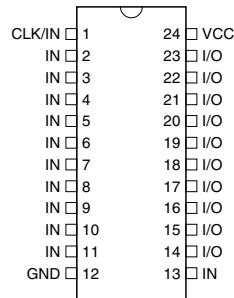
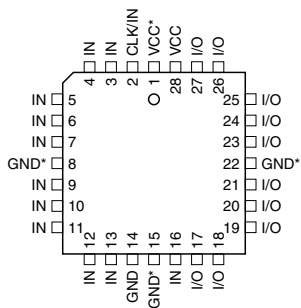

Figure 2-3. PLCC



Note: For PLCC, P1, P8, P15 and P22 can be left unconnected. For superior performance, connect VCC to pin 1 and GND to 8, 15, and 22

3. Absolute Maximum Ratings*

Temperature Under Bias	-40°C to +85°C
Storage Temperature.....	-65°C to +150°C
Voltage on Any Pin with Respect to Ground.....	-2.0V to +7.0V ⁽¹⁾
Voltage on Input Pins with Respect to Ground During Programming.....	-2.0V to +14.0V ⁽¹⁾
Programming Voltage with Respect to Ground.....	-2.0V to +14.0V ⁽¹⁾

*NOTICE: Stresses beyond those listed under “Absolute Maximum Ratings” may cause permanent damage to the device. This is a stress rating only and functional operation of the device at these or any other conditions beyond those indicated in the operational sections of this specification is not implied. Exposure to absolute maximum rating conditions for extended periods may affect device reliability.

Note: 1. Minimum voltage is -0.6V DC, which may undershoot to -2.0V for pulses of less than 20ns. Maximum output pin voltage is $V_{CC} + 0.75V$ DC, which may overshoot to 7.0V for pulses of less than 20ns.

4. DC and AC Operating Conditions

	Commercial	Industrial
Operating Temperature (Ambient)	0°C - 70°C	-40°C - 85°C
V_{CC} Power Supply	5V ± 5%	5V ± 10%

4.1 DC Characteristics

Symbol	Parameter	Condition	Min	Typ	Max	Units	
I_{IL}	Input or I/O Low Leakage Current	$0 \leq V_{IN} \leq V_{IL} (Max)$ $3.5 \leq V_{IN} \leq V_{CC}$			-10	μA	
I_{IH}	Input or I/O High Leakage Current				10	μA	
I_{CC}	Clocked Power Supply Current	$V_{CC} = Max$ Outputs Open, $f = 15MHz$	CZ-12, 15	Com	90	150	mA
			CZ-15	Ind	90	180	mA
			CQZ-20	Com	40	60	mA
			CQZ-20	Ind	40	80	mA
I_{SB}	Power Supply Current, Standby	$V_{CC} = Max$ $V_{IN} = MAX$ Outputs Open	CZ-12, 15	Com	5	100	μA
			CZ-15	Ind	5	120	μA
			CQZ-20	Com	5	100	μA
			CQZ-20	Ind	5	120	μA
$I_{OS}^{(1)}$	Output Short Circuit Current	$V_{OUT} = 0.5V$			-130	mA	
V_{IL}	Input Low Voltage		-0.5		0.8	V	
V_{IH}	Input High Voltage		2.0		$V_{CC} + 0.75$	V	
V_{OL}	Output Low Voltage	$V_{IN} = V_{IH} \text{ or } V_{IL}$ $V_{CC} = Min,$ $I_{OL} = 16mA$			0.5	V	
V_{OH}	Output High Voltage	$V_{IN} = V_{IH} \text{ or } V_{IL}$ $V_{CCIO} = Min,$ $I_{OH} = -4.0mA$	2.4			V	

Note: 1. Not more than one output at a time should be shorted. Duration of short circuit test should not exceed 30 sec



4.2 AC Waveforms

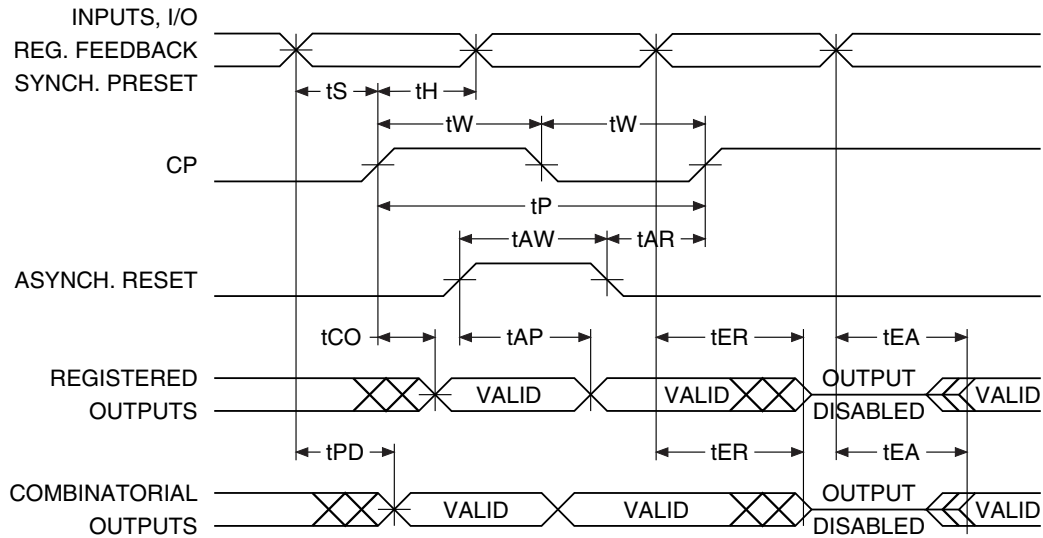

4.3 AC Characteristics⁽¹⁾

Symbol	Parameter	-12		-15		-20		Units
		Min	Max	Min	Max	Min	Max	
t_{PD}	Input or Feedback to Non-registered Output	3	12	3	15	3	20	ns
t_{CF}	Clock to Feedback		6		4.5		8	ns
t_{CO}	Clock to Output	2	8	2	8	2	12	ns
t_S	Input or Feedback Setup Time	10		10		14		ns
t_H	Input Hold Time	0		0		0		ns
t_W	Clock Width	6		6		10		ns
f_{MAX}	External Feedback $1/(t_S + t_{CO})$ Internal Feedback $1/(t_S + t_{CF})$ No Feedback $1/(t_P)$		55.5 62 83.3		55.5 69 83.3		38.5 45.5 50.0	MHz MHz MHz
t_{EA}	Input to Output Enable - Product Term	3	12	3	15	3	20	ns
t_{ER}	Input to Output Disable - Product Term	2	15	3	15	3	20	ns
t_{PZX}	OE Pin to Output Enable	2	12	2	15	2	20	ns
t_{PXZ}	OE Pin to Output Disable	2	15	2	15	2	20	ns
t_{AP}	Input or I/O to Asynchronous Reset of Register	3	10	3	15	3	22	ns
t_{SP}	Setup Time, Synchronous Preset	10		10		14		ns
t_{AW}	Asynchronous Reset Width	7		8		20		ns
t_{AR}	Asynchronous Reset Recovery Time	5		6		20		ns
t_{SPR}	Synchronous Preset to Clock Recovery Time	10		10		14		ns

Note: 1. See ordering information for valid part numbers

4.4 Input Test Waveforms

4.4.1 Input Test Waveforms and Measurement Levels

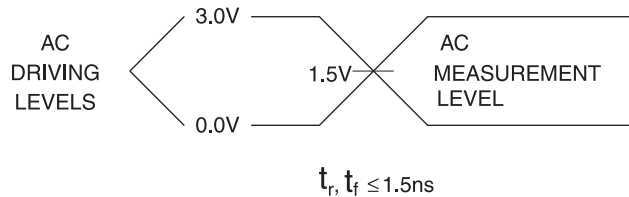

4.4.2 Output Test Loads

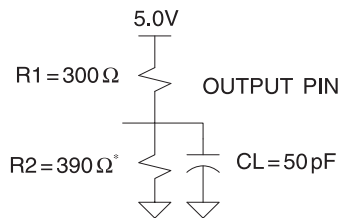

Note: Similar competitor devices are specified with slightly different loads. These load differences may affect output signals' delay and slew rate. Atmel devices are tested with sufficient margins to meet compatible device specification conditions.

4.5 Pin Capacitance

Table 4-1. Pin Capacitance ($f = 1\text{MHz}$, $T = 25\text{C}^{(1)}$)

	Typ	Max	Units	Conditions
C_{IN}	8	10	pF	$V_{\text{IN}} = 0\text{V}$; $f = 1.0\text{MHz}$
$C_{\text{I/O}}$	8	10	pF	$V_{\text{OUT}} = 0\text{V}$; $f = 1.0\text{MHz}$

Note: 1. Typical values for nominal supply voltage. This parameter is only sampled and is not 100% tested

4.6 Power-up Reset

The registers in the Atmel® ATF22V10CZ/CQZ are designed to reset during power-up. At a point delayed slightly from V_{CC} crossing V_{RST} , all registers will be reset to the low state. The output state will depend on the polarity of the buffer.

This feature is critical for state machine initialization. However, due to the asynchronous nature of reset and the uncertainty of how V_{CC} actually rises in the system, the following conditions are required:

1. The V_{CC} rise must be monotonic and start below 0.7V
2. The clock must remain stable during T_{PR}
3. After T_{PR} occurs, all input and feedback setup times must be met before driving the clock pin high

4.7 Preload of Register Outputs

The ATF22V10CZ/CQZ's registers are provided with circuitry to allow loading of each register with either a high or a low. This feature will simplify testing since any state can be forced into the registers to control test sequencing. A JEDEC file with preload is generated when a source file with vectors is compiled. Once downloaded, the JEDEC file preload sequence will be done automatically by most of the approved programmers after the programming.

5. Electronic Signature Word

There are 64-bits of programmable memory that are always available to the user, even if the device is secured. These bits can be used for user-specific data.

6. Security Fuse Usage

A single fuse is provided to prevent unauthorized copying of the Atmel® ATF22V10CZ/CQZ fuse patterns. Once programmed, fuse verify and preload are inhibited. However, the 64-bit User Signature remains accessible. The security fuse should be programmed last, as its effect is immediate.

7. Programming/Erasing

Programming/erasing is performed using standard PLD programmers. See CMOS PLD Programming Hardware and Software Support for information on software/programming.

Figure 7-1. Programming/Erasing Timing

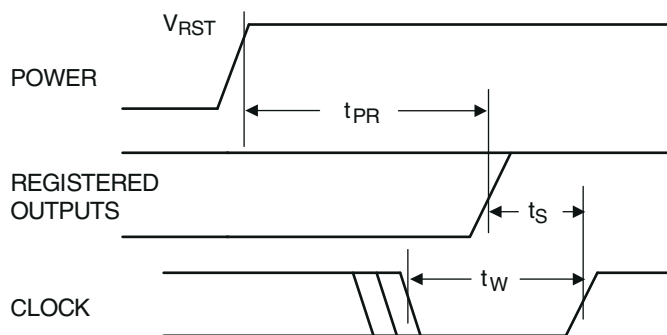

Table 7-1. Programming/Erasing

Parameter	Description	Typ	Max	Units
T_{PR}	Power-up Reset Time	600	1000	ns
V_{RST}	Power-up Reset Voltage	3.8	4.5	V

8. Input and I/O Pull-ups

All Atmel® ATF22V10CZ/CQZ family members have internal input and I/O pin-keeper circuits. Therefore, whenever inputs or I/Os are not being driven externally, they will maintain their last driven state. This ensures that all logic array inputs and device outputs are at known states. These are relatively weak active circuits that can be easily overridden by TTL-compatible drivers (see input and I/O diagrams below).

Figure 8-1. Input Diagram

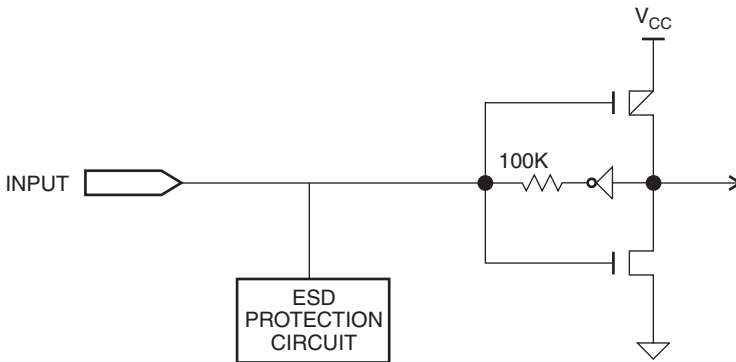
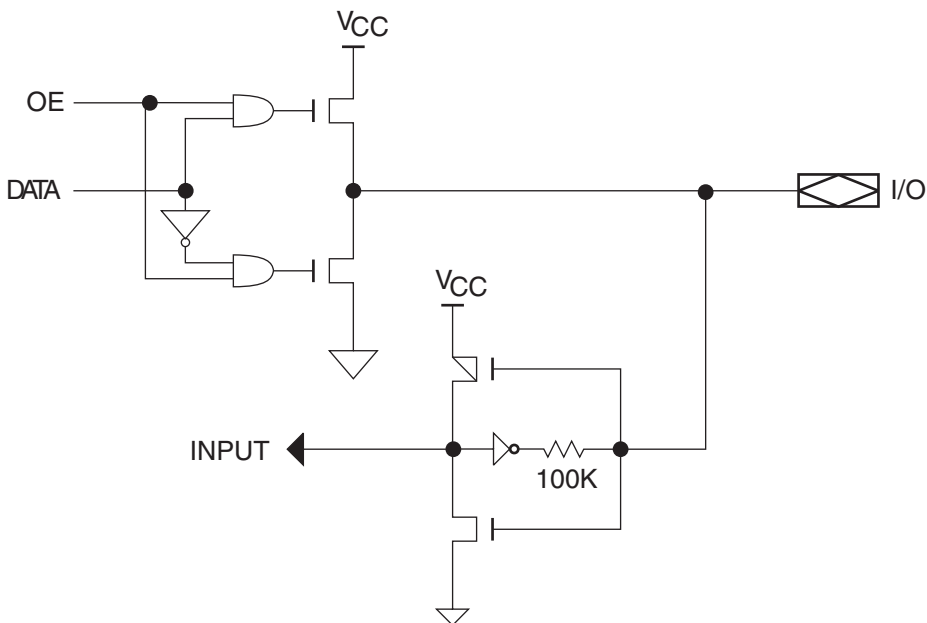

Figure 8-2. I/O Diagram



9. Compiler Mode Selection

Table 9-1. Compiler Mode Selection

	PAL Mode (5828 Fuses)	GAL Mode (5892 Fuses)
Synario	Atmel ATF22V10C (DIP) Atmel ATF22V10C (PLCC)	Atmel ATF22V10C DIP (UES) Atmel ATF22V10C PLCC (UES)
WINCUPPL	P22V10 P22V10LCC	G22V10 G22V10LCC

10. Functional Logic Diagram Description

The Functional Logic Diagram describes the Atmel® ATF22V10CZ/CQZ architecture.

The ATF22V10CZ/CQZ has 12 inputs and 10 I/O macrocells. Each macrocell can be configured into one of four output configurations: active high/low, registered/combinatorial output. The universal architecture of the ATF22V10CZ/CQZ can be programmed to emulate most 24-pin PAL devices.

Unused product terms are automatically disabled by the compiler to decrease power consumption. A security fuse, when programmed, protects the contents of the ATF22V10CZ/CQZ. Eight bytes (64-fuses) of User Signature are accessible to the user for purposes such as storing project name, part number, revision or date. The User Signature is accessible regardless of the state of the security fuse.

Figure 10-1. Functional Logic Diagram



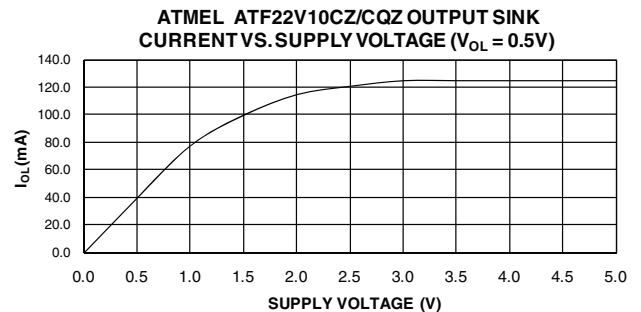
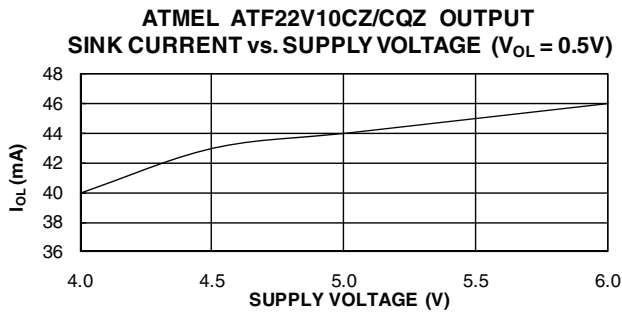
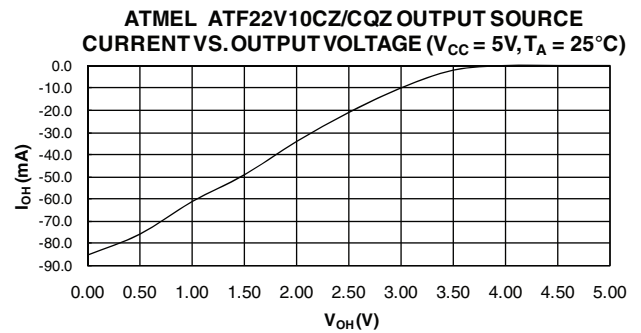
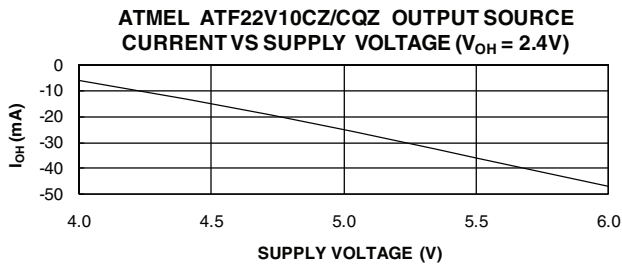
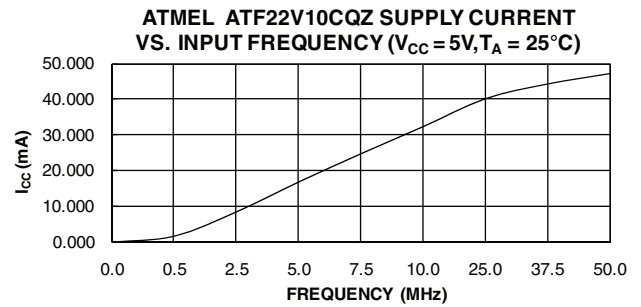
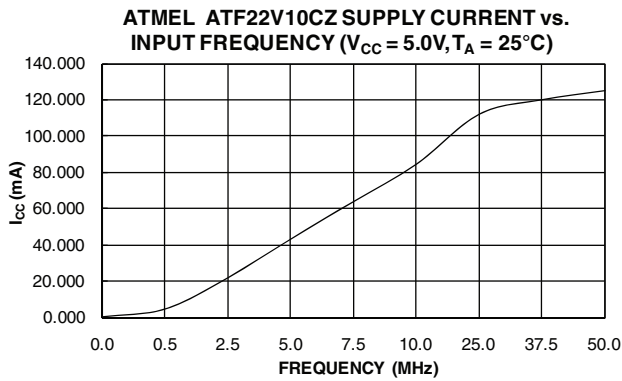
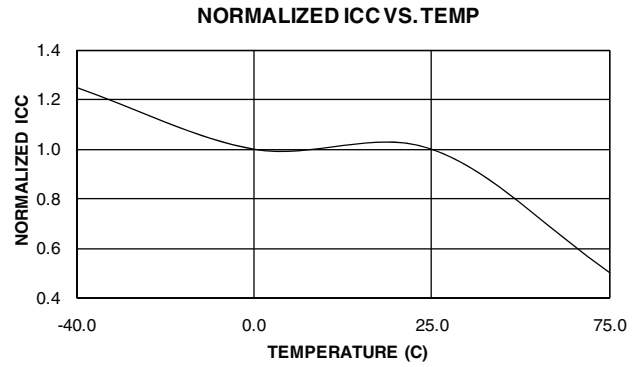
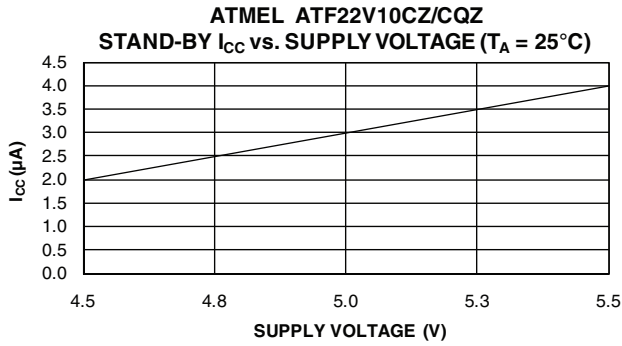

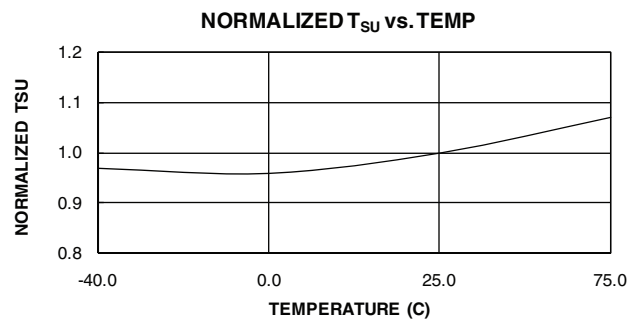
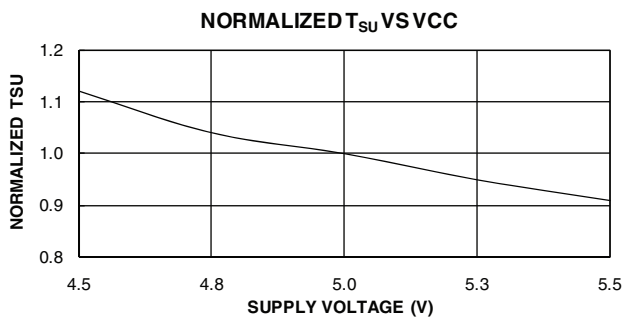
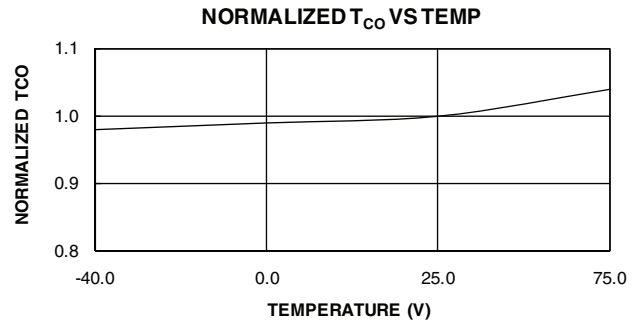
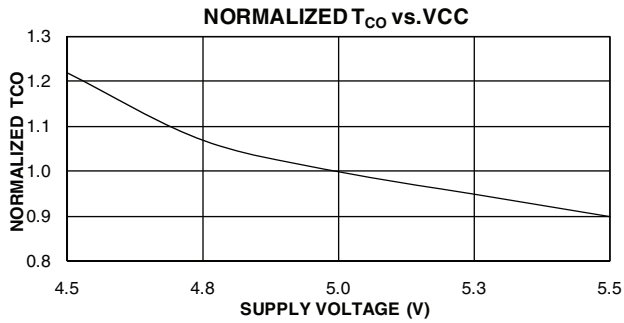
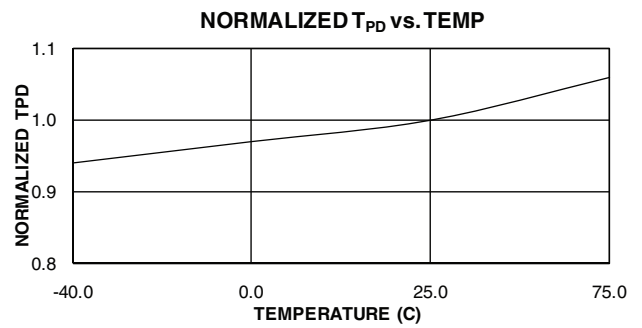
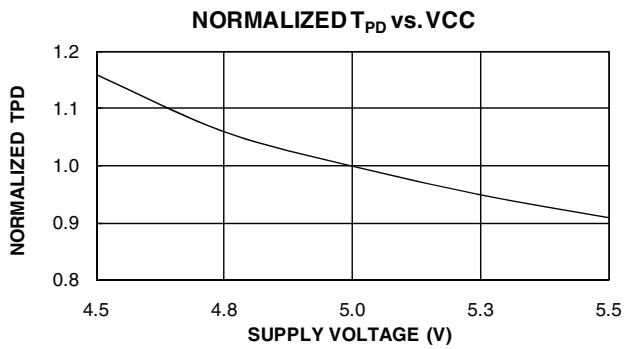
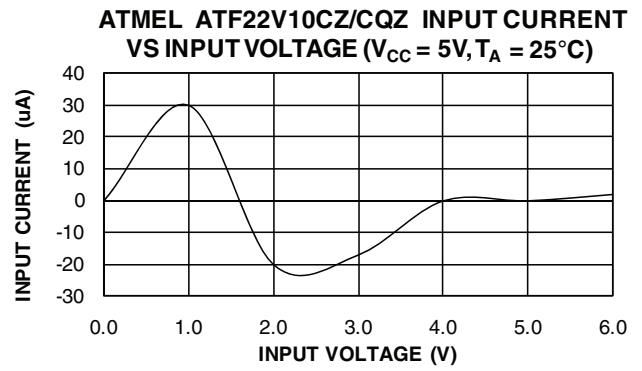
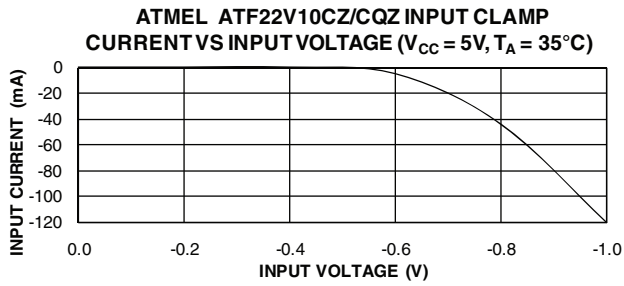

**ATMEL ATF22V10C
DELTA T_{PD} vs. OUTPUT LOADING**

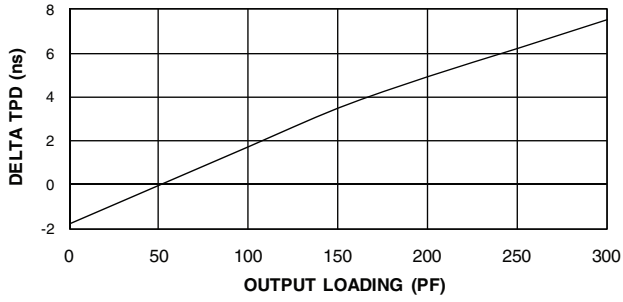

**ATMEL ATF22V10C
DELTA T_{CO} vs. OUTPUT LOADING**

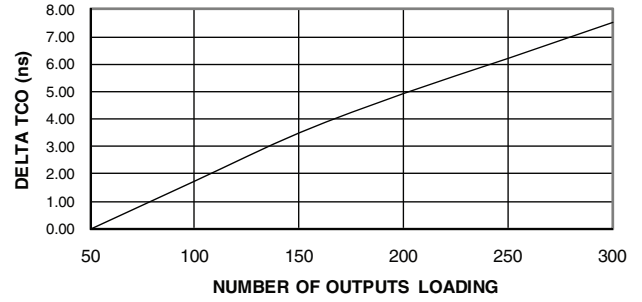

DELTA T_{PD} vs. # OF OUTPUT SWITCHING

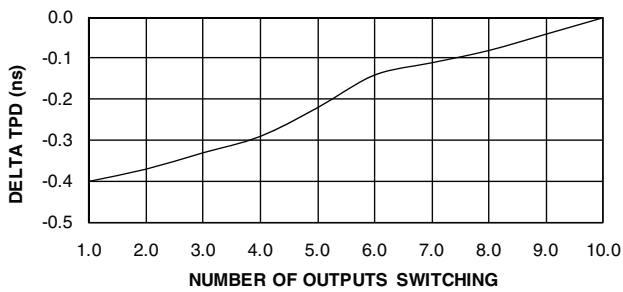

DELTA T_{CO} vs. # OF OUTPUT SWITCHING

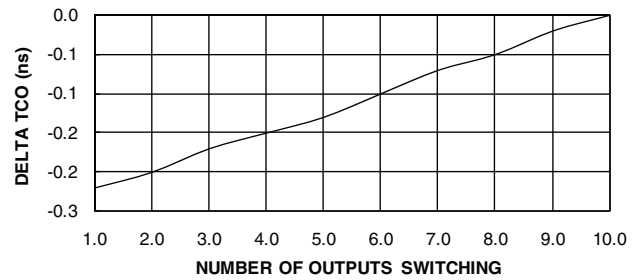

11. Ordering Information

11.1 Standard Package Options

t_{PD} (ns)	t_S (ns)	t_{CO} (ns)	Ordering Code	Package	Operation Range
12	10	8	ATF22V10CZ-12JC	28J	Commercial (0-C to 70-C)
			ATF22V10CZ-12PC	24P3	
			ATF22V10CZ-12SC	24S	
			ATF22V10CZ-12XC	24X	
15	10	8	ATF22V10CZ-15JC	28J	Commercial (0-C to 70-C)
			ATF22V10CZ-15PC	24P3	
			ATF22V10CZ-15SC	24S	
			ATF22V10CZ-15JI	28J	Industrial (-40-C to +85-C)
			ATF22V10CZ-15PI	24P3	
			ATF22V10CZ-15SI	24S	
20	14	12	ATF22V10CQZ-20JC	28J	Commercial (0-C to 70-C)
			ATF22V10CQZ-20PC	24P3	
			ATF22V10CQZ-20SC	24S	
			ATF22V10CQZ-20XC	24X	
			ATF22V10CQZ-20JI	28J	Industrial (-40-C to +85-C)
			ATF22V10CQZ-20PI	24P3	
			ATF22V10CQZ-20SI	24S	
			ATF22V10CQZ-20XI	24X	

Note: Shaded parts are being obsoleted and are not recommended for new designs. Customers should transition to ROHS offering

11.2 Atmel ATF22V10CQZ Green Package Options (Pb/Halide-free/RoHS Compliant)

t_{PD} (ns)	t_S (ns)	t_{CO} (ns)	Ordering Code	Package	Operation Range
20	14	12	ATF22V10CQZ-20JU	28J	Industrial (-40-C to +85-C)
			ATF22V10CQZ-20PU	24P3	
			ATF22V10CQZ-20SU	24S	
			ATF22V10CQZ-20XU	24X	

11.3 Using “C” Product for Industrial

To use commercial product for Industrial temperature ranges, down-grade one speed grade from the “I” to the “C” device (7ns “C” = 10ns “I”) and de-rate power by 30%.

Package Type	
28J	28-lead, Plastic J-leded Chip Carrier (PLCC)
24P3	24-pin, 0.300", Plastic Dual Inline Package (PDIP)
24S	24-lead, 0.300" Wide, Plastic Gull-Wing Small Outline (SOIC)
24X	24-lead, 4.4mm Wide, Plastic Thin Shrink Small Outline (TSSOP)

12. Packaging Information

12.1 28J – PLCC

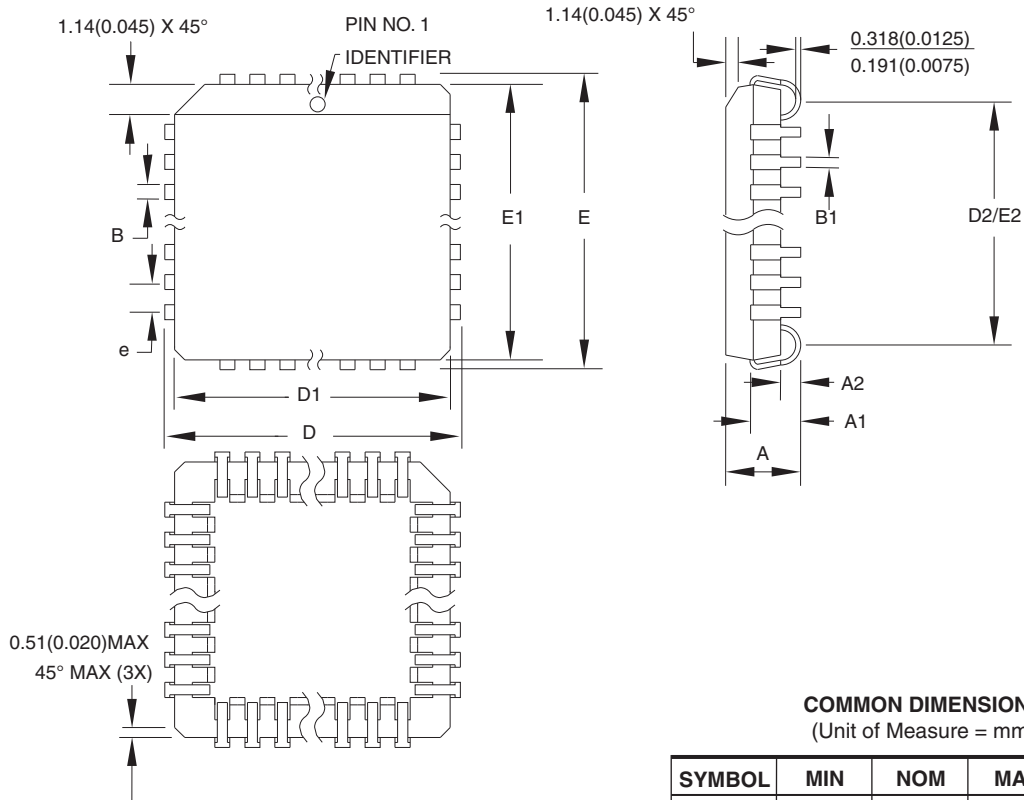

COMMON DIMENSIONS
(Unit of Measure = mm)

SYMBOL	MIN	NOM	MAX	NOTE
A	4.191	–	4.572	
A1	2.286	–	3.048	
A2	0.508	–	–	
D	12.319	–	12.573	
D1	11.430	–	11.582	Note 2
E	12.319	–	12.573	
E1	11.430	–	11.582	Note 2
D2/E2	9.906	–	10.922	
B	0.660	–	0.813	
B1	0.330	–	0.533	
e	1.270 TYP			

- Notes:
1. This package conforms to JEDEC reference MS-018, Variation AB.
 2. Dimensions D1 and E1 do not include mold protrusion. Allowable protrusion is .010"(0.254mm) per side. Dimension D1 and E1 include mold mismatch and are measured at the extreme material condition at the upper or lower parting line.
 3. Lead coplanarity is 0.004" (0.102mm) maximum.

10/04/01



Package Drawing Contact:
packagedrawings@atmel.com

TITLE

28J, 28-lead, Plastic J-leaded Chip Carrier (PLCC)

DRAWING NO.

28J

REV.

B

12.2 24P3 – PDIP

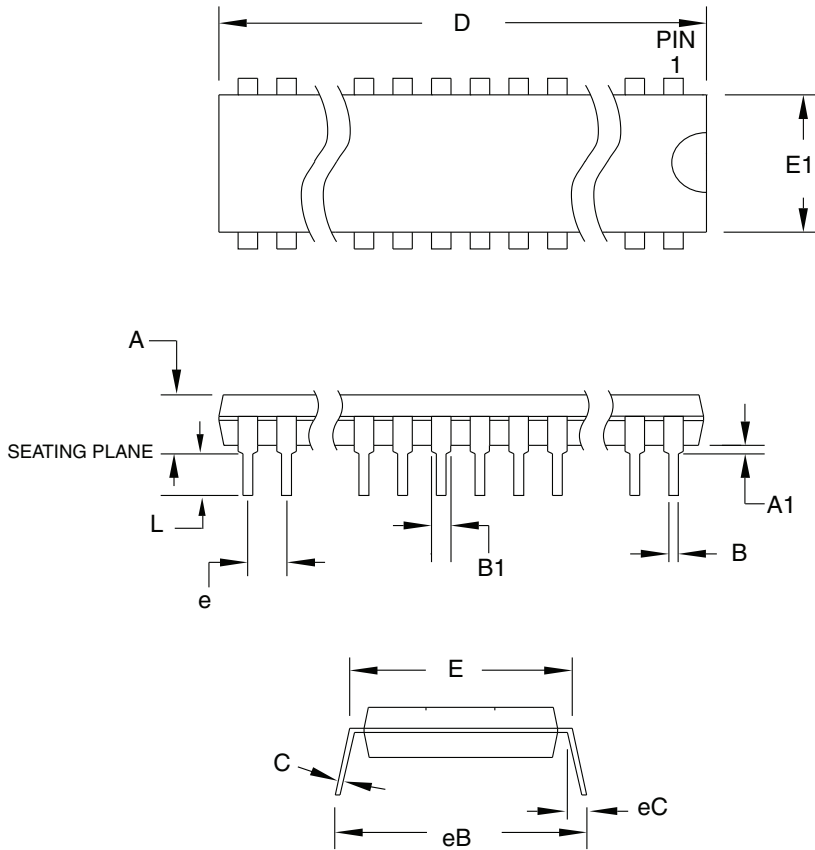

COMMON DIMENSIONS
(Unit of Measure = mm)

SYMBOL	MIN	NOM	MAX	NOTE
A	–	–	5.334	
A1	0.381	–	–	
D	31.623	–	32.131	Note 2
E	7.620	–	8.255	
E1	6.096	–	7.112	Note 2
B	0.356	–	0.559	
B1	1.270	–	1.651	
L	2.921	–	3.810	
C	0.203	–	0.356	
eB	–	–	10.922	
eC	0.000	–	1.524	
e	2.540 TYP			

- Notes:
1. This package conforms to JEDEC reference MS-001, Variation AF.
 2. Dimensions D and E1 do not include mold Flash or Protrusion. Mold Flash or Protrusion shall not exceed 0.25mm (0.010").

6/1/04



Package Drawing Contact:
packagedrawings@atmel.com

TITLE
24P3, 24-lead (0.300"/7.62mm Wide) Plastic Dual
Inline Package (PDIP)

DRAWING NO.

24P3

REV.

D

12.3 24S – SOIC

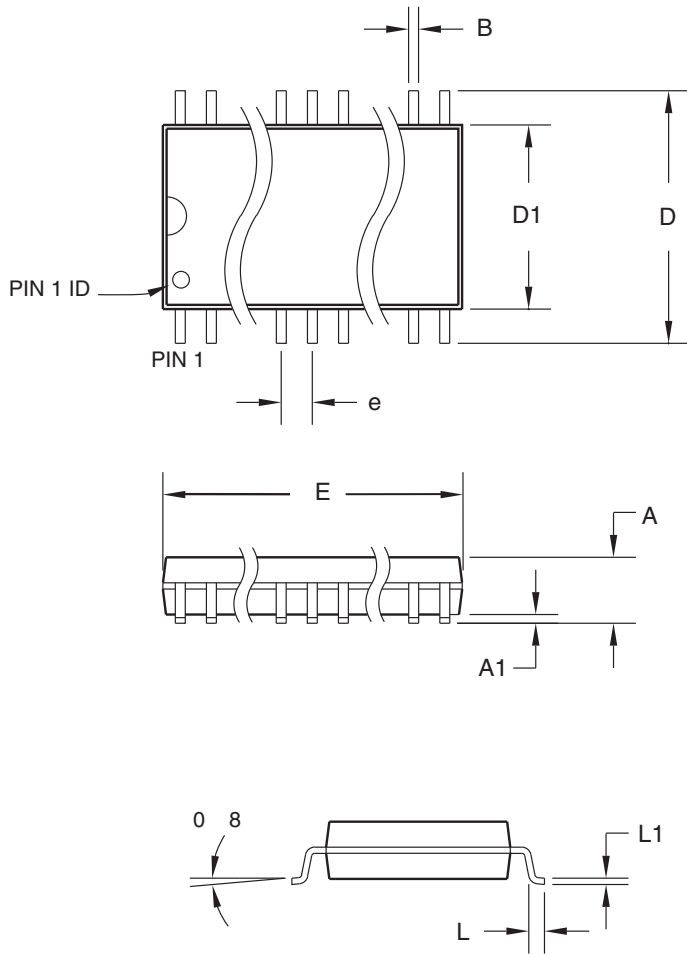

COMMON DIMENSIONS
(Unit of Measure = mm)

SYMBOL	MIN	NOM	MAX	NOTE
A	–	–	2.65	
A1	0.10	–	0.30	
D	10.00	–	10.65	
D1	7.40	–	7.60	
E	15.20	–	15.60	
B	0.33	–	0.51	
L	0.40	–	1.27	
L1	0.23	–	0.32	
e	1.27 BSC			

06/17/2002



Package Drawing Contact:
packagedrawings@atmel.com

TITLE
24S, 24-lead (0.300" body) Plastic Gull Wing Small
Outline (SOIC)

DRAWING NO.	REV.
24S	B

12.4 24X – TSSOP

Dimensions in Millimeter and (Inches)*
 JEDEC STANDARD MO-153 AD
 Controlling dimension: millimeters

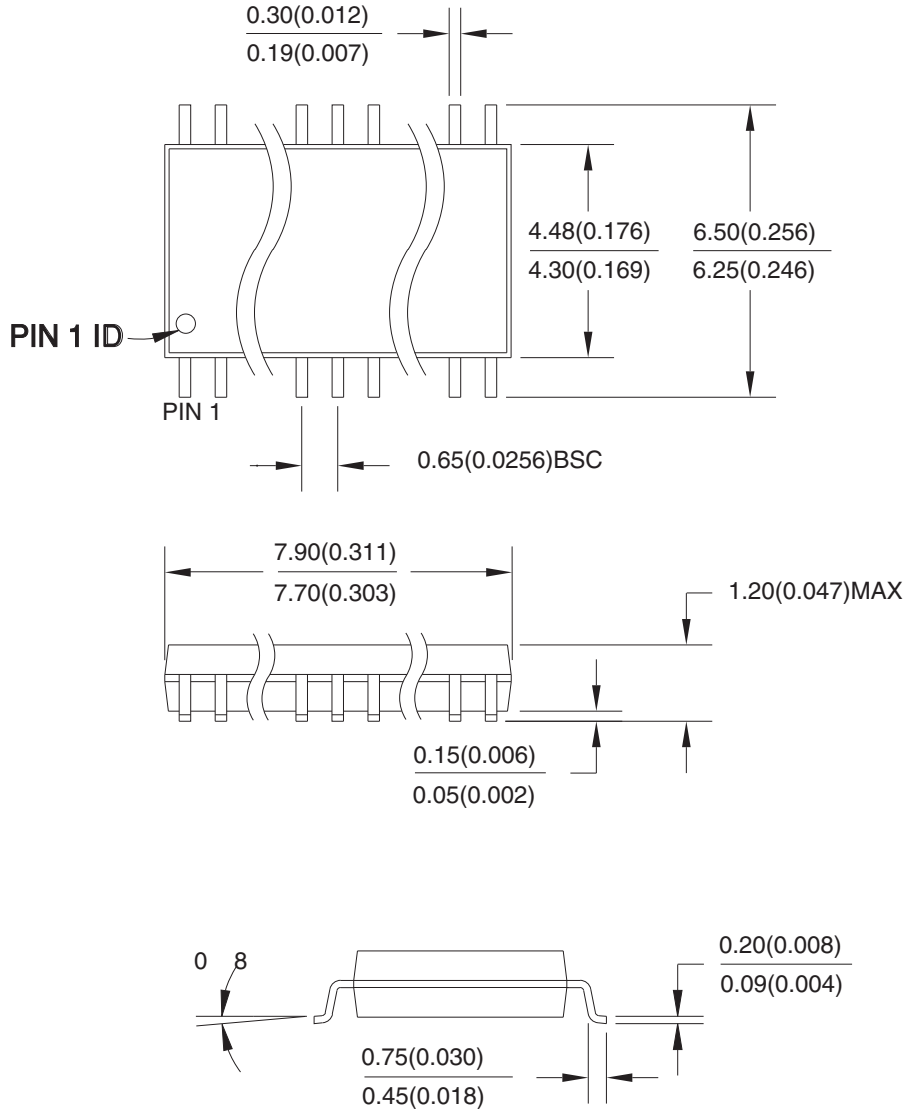

04/11/2001



Package Drawing Contact:
 packagedrawings@atmel.com

TITLE
 24X, 24-lead (4.4mm body width) Plastic Thin Shrink
 Small Outline Package (TSSOP)

DRAWING NO.

24X

REV.

A



13. Revision History

Doc. Rev.	Date	Comments
0778L	08/2010	Change t_s (ns) from 4.5 to 10 in Standard Package Options. 06/2014 The ATF22V10CZ is obsolete. Replaced by ATF22V10CQZ.
0778K	07/2010	Remove Commercial Temperature Range For I_{SB} , change 25 μ A Max to 100 μ A max for commercial grade parts and 50 μ A Max to 120 μ A for Industrial grade parts Shade Standard Package Options and add note, "Shaded parts are not recommended for new designs. Customers should transition to ROHS offering" Remove Atmel ATF22V10CZ-15XC and Atmel ATF22V10CZ-15XI from Standard Package Options
0778J	11/2005	Add Green Package options



Headquarters

Atmel Corporation

2325 Orchard Parkway
San Jose, CA 95131
USA
Tel: (+1)(408) 441-0311
Fax: (+1)(408) 487-2600
www.atmel.com

International

Atmel Asia Limited

Unit 01-5 & 16, 19/F
BEA Tower, Millennium City 5
418 Kwun Tong Road
Kwun Tong, Kowloon
HONG KONG
Tel: (+852) 2245-6100
Fax: (+852) 2722-1369

Atmel Munich GmbH

Business Campus
Parkring 4
D-85748 Garching b. Munich
GERMANY
Tel: (+49) 89-31970-0
Fax: (+49) 89-3194621

Atmel Japan

9F, Tonetsu Shinkawa Bldg.
1-24-8 Shinkawa
Chuo-ku, Tokyo 104-0033
JAPAN
Tel: (+81) 3-3523-3551
Fax: (+81) 3-3523-7581

Product Contact

Technical Support

pld@atmel.com

Sales Contact

www.atmel.com/contacts

Literature Requests

www.atmel.com/literature

Disclaimer: The information in this document is provided in connection with Atmel products. No license, express or implied, by estoppel or otherwise, to any intellectual property right is granted by this document or in connection with the sale of Atmel products. **EXCEPT AS SET FORTH IN ATMEL'S TERMS AND CONDITIONS OF SALE LOCATED ON ATMEL'S WEB SITE, ATMEL ASSUMES NO LIABILITY WHATSOEVER AND DISCLAIMS ANY EXPRESS, IMPLIED OR STATUTORY WARRANTY RELATING TO ITS PRODUCTS INCLUDING, BUT NOT LIMITED TO, THE IMPLIED WARRANTY OF MERCHANTABILITY, FITNESS FOR A PARTICULAR PURPOSE, OR NON-INFRINGEMENT. IN NO EVENT SHALL ATMEL BE LIABLE FOR ANY DIRECT, INDIRECT, CONSEQUENTIAL, PUNITIVE, SPECIAL OR INCIDENTAL DAMAGES (INCLUDING, WITHOUT LIMITATION, DAMAGES FOR LOSS OF PROFITS, BUSINESS INTERRUPTION, OR LOSS OF INFORMATION) ARISING OUT OF THE USE OR INABILITY TO USE THIS DOCUMENT, EVEN IF ATMEL HAS BEEN ADVISED OF THE POSSIBILITY OF SUCH DAMAGES.** Atmel makes no representations or warranties with respect to the accuracy or completeness of the contents of this document and reserves the right to make changes to specifications and product descriptions at any time without notice. Atmel does not make any commitment to update the information contained herein. Unless specifically provided otherwise, Atmel products are not suitable for, and shall not be used in, automotive applications. Atmel's products are not intended, authorized, or warranted for use as components in applications intended to support or sustain life.

© 2010 Atmel Corporation. All rights reserved.

Atmel®, logo and combinations thereof, Everywhere You Are® and others, are registered trademarks or trademarks of Atmel Corporation or its subsidiaries. Other terms and product names may be trademarks of others.

Looking for pricing, stock, or lifecycle information?

Click below to explore more details on WIN SOURCE:

 [View ATF22V10CQZ-20JU on WIN SOURCE](#)

 [Atmel Information](#)

Optimize Your Supply Chain with WIN SOURCE Solutions

-  Global Sourcing Solution
-  Obsolete Management
-  Cost Control Management
-  Shortage Management
-  Alternative Solution
-  Excess Inventory Management