



**THE DATASHEET OF
ATF22LV10C-10PC**



Features

- 3.0V to 5.5V Operating Range
- Advanced Low-voltage Electrically-erasable Programmable Logic Device
- User-controlled Power-down Pin Option
- Pin-controlled Standby Power (10 μ A Typical)
- Well-suited for Battery Powered Systems
- 10ns Maximum Propagation Delay
- CMOS and TTL Compatible Inputs and Outputs
- Latch Feature Hold Inputs to Previous Logic States
- Advanced Electrically-erasable Technology
 - Reprogrammable
 - 100% Tested
- High-reliability CMOS Process
 - 20 year Data Retention
 - 100 Erase/Write Cycles
 - 2,000V ESD Protection
 - 200mA Latchup Immunity
- Industrial Temperature Ranges
- Dual-in-line and Surface Mount Packages in Standard Pinouts
- Inputs are 5V Tolerant
- Green Package Options (Pb/Halide-free/RoHS Compliant) Available
- Applications include Glue logic for 3.3V systems, DMA Control, State Machine Control, Graphics processing

1. Description

The Atmel[®] ATF22LV10C is a high-performance CMOS (electrically erasable) programmable logic device (PLD) that utilizes the Atmel proven electrically erasable Flash memory technology. Speeds down to 10ns and power dissipation as low as 10mA are offered. All speed ranges are specified over the 3.0V to 5.5V range for industrial and commercial temperature ranges.

The ATF22LV10C provides a low-voltage and user controlled “zero” power CMOS PLD solution. A user-controlled power-down feature offers “zero” (10 μ A typical) standby power. This feature allows the user to manage total system power to meet specific application requirements and enhance reliability, all without sacrificing speed. (The Atmel ATF22LV10CQZ provides edge-sensing “zero” standby power (3 μ A typical), as well as low voltage operation. See the ATF22LV10CQZ datasheet.)

The ATF22LV10C is capable of operating at supply voltages down to 3.0V. When the power-down pin is active, the device is placed into a zero standby power-down mode. When the power-down pin is not used or active, the device operates in a full power low voltage mode. Pin “keeper” circuits on input and output pins hold pins to their previous logic levels when idle, which eliminate static power consumed by pull-up resistors.

The ATF22LV10C macrocell incorporates a variable product term architecture. Each output is allocated from 8 to 16 product terms which allows highly-complex logic functions to be realized. Two additional product terms are included to provide synchronous reset and asynchronous reset. These additional product terms are common to all ten registers and are automatically cleared upon power-up. Register preload simplifies testing. A security fuse prevents unauthorized copying of programmed fuse patterns.



High-performance Electrically Erasable Programmable Logic Device

Atmel ATF22LV10C

See separate datasheet for Atmel
ATF22LV10C(Q)Z option



Figure 1-1. Block Diagram

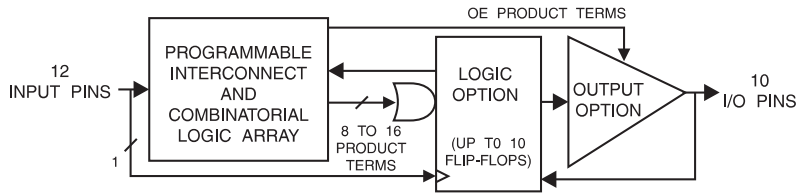

Figure 1-2. Pin Configurations

Pin Configurations (All Pinouts Top View)

Pin Name	Function
CLK	Clock
IN	Logic Inputs
I/O	Bi-directional Buffers
VCC	(3V to 5.5V) Supply
PD	Programmable Power-down

Figure 1-3. TSSOP

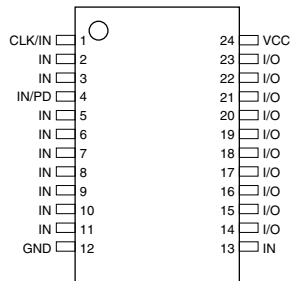

Figure 1-4. DIP/SOIC

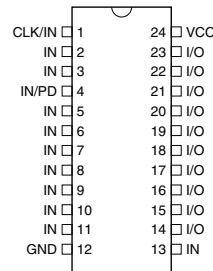
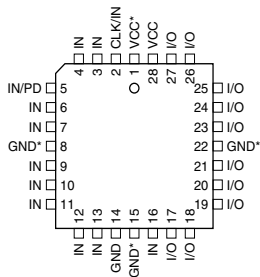

Figure 1-5. PLCC



Note: For PLCC, pins 1, 8, 15, and 22 can be left unconnected. For superior performance, connect VCC to pin 1 and GND to 8, 15, and 22

2. Absolute Maximum Ratings*

Temperature Under Bias	-40°C to +85°C
Storage Temperature.....	-65°C to +150°C
Voltage on Any Pin with Respect to Ground.....	-2.0V to +7.0V ⁽¹⁾
Voltage on Input Pins with Respect to Ground During Programming.....	-2.0V to +14.0V ⁽¹⁾
Programming Voltage with Respect to Ground.....	-2.0V to +14.0V ⁽¹⁾

***NOTICE:** Stresses beyond those listed under “Absolute Maximum Ratings” may cause permanent damage to the device. This is a stress rating only and functional operation of the device at these or any other conditions beyond those indicated in the operational sections of this specification is not implied. Exposure to absolute maximum rating conditions for extended periods may affect device reliability.

Note: 1. Minimum voltage is -0.6V DC, which may undershoot to -2.0V for pulses of less than 20ns. Maximum output pin voltage is $V_{CC} + 0.75V$ DC, which may overshoot to 7.0V for pulses of less than 20ns.

3. DC and AC Operating Conditions

	Commercial	Industrial
Operating Temperature (Ambient)	0°C - 70°C	-40°C - 85°C
V_{CC} Power Supply	3.0V - 5.5V	3.0V - 5.5V

3.1 DC Characteristics

Symbol	Parameter	Condition ⁽²⁾	Min	Typ	Max	Units
I_{IL}	Input or I/O Low Leakage Current	$0 \leq V_{IN} \leq V_{IL}(\text{Max})$			-10	μA
I_{IH}	Input or I/O High Leakage Current	$(V_{CC} - 0.2)V \leq V_{IN} \leq V_{CC}$			10	μA
I_{CC}	Power Supply Current	$V_{CC} = \text{Max}, V_{IN} = \text{Max}$ Outputs Open	Com. Ind.	55 60	85 90	mA mA
I_{CC2}	Clocked Power Supply Current	$V_{CC} = \text{Max}$ Outputs Open, $f = 15\text{MHz}$	Com. Ind.		100 105	mA mA
I_{PD}	Power Supply Current, Power-down Mode	$V_{CC} = 3.6V, \text{Max}$ $V_{IN} = 0, \text{Outputs Open}$	Com. Ind.	10 10	100 120	μA μA
$I_{OS}^{(1)}$	Output Short Circuit Current	$V_{OUT} = 0.5V$			-130	mA
V_{IL}	Input Low Voltage		-0.5		0.8	V
V_{IH}	Input High Voltage		2.0		$V_{CC} + 0.75$	V
V_{OL}	Output Low Voltage	$V_{IN} = V_{IH} \text{ or } V_{IL}$ $V_{CC} = \text{Min}$ $I_{OL} = 16\text{mA}$			0.5	V
V_{OH}	Output High Voltage	$V_{IN} = V_{IH} \text{ or } V_{IL}$ $V_{CC} = \text{Min}$ $I_{OH} = -2.0\text{mA}$	2.4			V
V_{OH}	Output High Voltage	$I_{OH} = -100\mu A$	$V_{CC} - 0.2V$			V

Notes: 1. Not more than one output at a time should be shorted. Duration of short circuit test should not exceed 30 sec
2. For DC characteristics, the test condition of $V_{CC} = \text{Max}$ corresponds to 3.6V

3.2 AC Waveforms

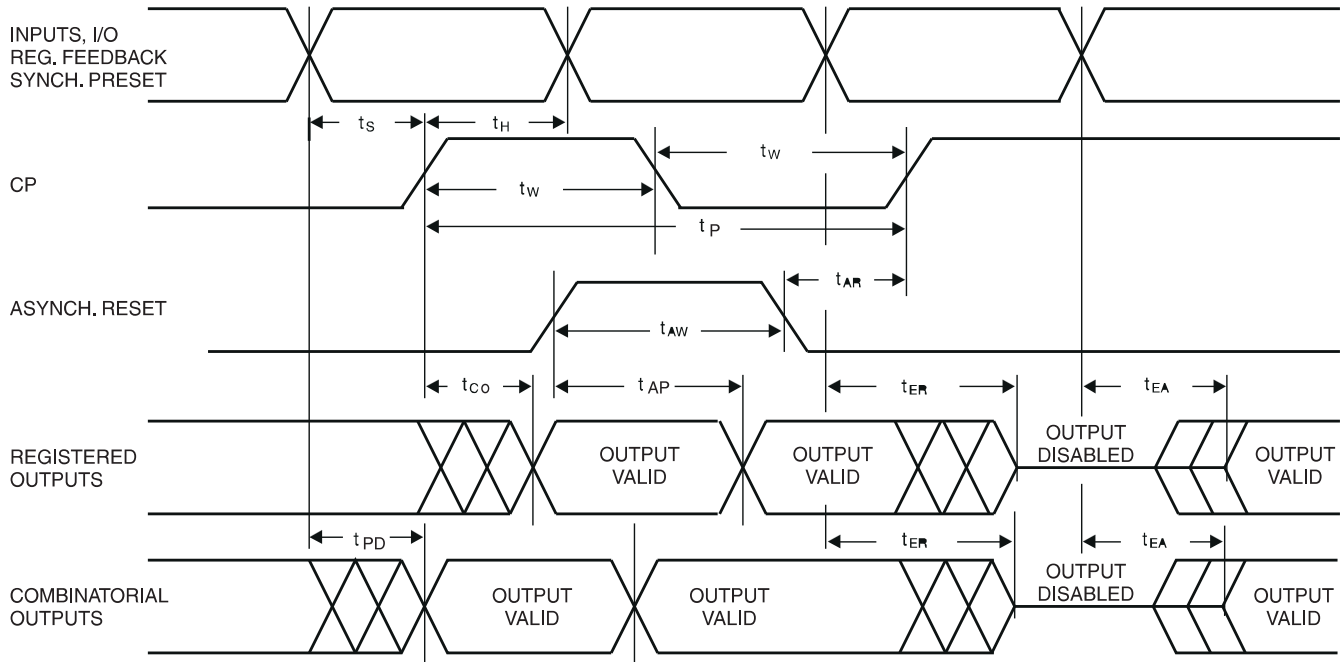

3.3 AC Characteristics(1)

Symbol	Parameter	-10		-15		Units
		Min	Max	Min	Max	
t_{PD}	Input or Feedback to Non-Registered Output	3	10	3	15	ns
t_{CF}	Clock to Feedback		5		8	ns
t_{CO}	Clock to Output	2	6.5	2	10	ns
t_S	Input or Feedback Setup Time	7.5		12		ns
t_H	Input Hold Time	0		0		ns
t_P	Clock Period	12		16		ns
t_W	Clock Width	6		8		ns
f_{MAX}	External Feedback $1/(t_S + t_{CO})$		71.4		45.5	MHz
	Internal Feedback $1/(t_S + t_{CF})$		80		50	MHz
	No Feedback $1/(t_P)$		83.3		62.5	MHz
t_{EA}	Input to Output Enable	3	12	3	15	ns
t_{ER}	Input to Output Disable	2	12	2	15	ns
t_{AP}	Input or I/O to Asynchronous Reset of Register	3	13	3	15	ns
t_{SP}	Setup Time, Synchronous Preset	10		10		ns
t_{AW}	Asynchronous Reset Width	8		8		ns
t_{AR}	Asynchronous Reset Recovery Time	6		6		ns
t_{SPR}	Synchronous Preset to Clock Recovery Time	10		10		ns

Note: 1. See ordering information for valid part numbers

3.4 Power-down AC Characteristics

Symbol	Parameter	-10		-15		Units
		Min	Max	Min	Max	
t_{IVDH}	Valid Input before PD High	10		15		ns
t_{GVDH}	Valid \overline{OE} before PD High	0		0		ns
t_{CVDH}	Valid Clock before PD High	0		0		ns
t_{DHIX}	Input Don't Care after PD High		10		15	ns
t_{DHGX}	\overline{OE} Don't Care after PD High		10		15	ns
t_{DHCX}	Clock Don't Care after PD High		10		15	ns
t_{DLIV}	PD Low to Valid Input		10		15	ns
t_{DLGV}	PD Low to Valid \overline{OE}		25		30	ns
t_{DLCV}	PD Low to Valid Clock		25		30	ns
t_{DLOV}	PD Low to Valid Output		30		35	ns

3.5 Input Test Waveforms and Measurement Levels

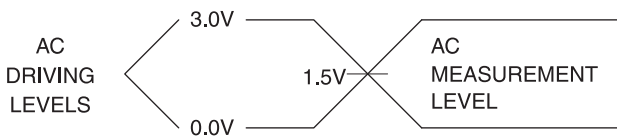

$$t_R, t_F < 1.5\text{ns}$$

3.6 Output Test Loads

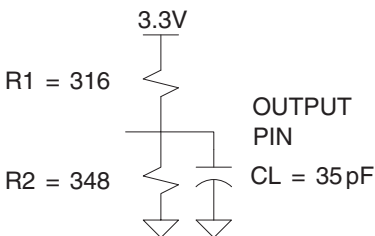

Note: Similar competitor devices are specified with slightly different loads. These load differences may affect output signals' delay and slew rate. Atmel® devices are tested with sufficient margins to meet compatible device specification conditions.

Table 3-1. Pin Capacitance (f = 1MHz, T = 25°C⁽¹⁾)

	Typ	Max	Units	Conditions
C_{IN}	5	8	pF	$V_{IN} = 0V$
C_{OUT}	6	8	pF	$V_{OUT} = 0V$

Note: 1. Typical values for nominal supply voltage. This parameter is only sampled and is not 100% tested

3.7 Power-up Reset

The registers in the Atmel® ATF22LV10C are designed to reset during power-up. At a point delayed slightly from V_{CC} crossing V_{RST} , all registers will be reset to the low state. The output state will depend on the polarity of the buffer.

This feature is critical for state machine initialization. However, due to the asynchronous nature of reset and the uncertainty of how V_{CC} actually rises in the system, the following conditions are required:

1. The V_{CC} rise must be monotonic and start below 0.7V
2. The clock must remain stable during T_{PR}
3. After T_{PR} , all input and feedback setup times must be met before driving the clock pin high

3.8 Preload of Register Outputs

The ATF22LV10C registers are provided with circuitry to allow loading of each register with either a high or a low. This feature will simplify testing since any state can be forced into the registers to control test sequencing. A JEDEC file with preload is generated when a source file with vectors is compiled. Once downloaded, the JEDEC file preload sequence will be done automatically by most of the approved programmers after the programming.

4. Electronic Signature Word

There are 64-bits of programmable memory that are always available to the user, even if the device is secured. These bits can be used for user-specific data.

5. Security Fuse Usage

A single fuse is provided to prevent unauthorized copying of the ATF22LV10C fuse patterns. Once programmed, fuse verify and preload are inhibited. However, the 64-bit User Signature remains accessible.

The security fuse should be programmed last, as its effect is immediate.

6. Programming/Erasing

Programming/erasing is performed using standard PLD programmers. See CMOS PLD Programming Hardware & Software Support for information on software/programming.

Table 6-1. Programming/Erasing

Parameter	Description	Typ	Max	Units
T_{PR}	Power-up Reset Time	600	1,000	ns
V_{RST}	Power-up Reset Voltage	2.5	3.0	V

7. Input and I/O Pin-keeper

All ATF22LV10C family members have internal input and I/O pin-keeper circuits. Therefore, whenever inputs or I/Os are not being driven externally, they will maintain their last driven state. This ensures that all logic array inputs and device outputs are at known states. These are relatively weak active circuits that can be easily overridden by TTL-compatible drivers (see Input and I/O diagrams on [page 7](#)).

8. Power-down Mode

The Atmel® ATF22LV10C includes an optional pin controlled power-down feature. When this mode is enabled, the PD pin acts as the power-down pin (Pin 4 on the DIP/SOIC packages and Pin 5 on the PLCC package). When the PD pin is high, the device supply current is reduced to less than 100mA. During power-down, all output data and internal logic states are latched and held. Therefore, all registered and combinatorial output data remain valid. Any outputs which were in an undetermined state at the onset of power-down will remain at the same state. During power-down, all input signals except the power-down pin are blocked. Input and I/O hold latches remain active to insure that pins do not float to indeterminate levels, further reducing system power. The power-down pin feature is enabled in the logic design file. Designs using the power-down pin may not use the PD pin logic array input. However, all other PD pin macrocell resources may still be used, including the buried feedback and foldback product term array inputs.

PD pin configuration is controlled by the design file, and appears as a separate fuse bit in the JEDEC file. When the power-down feature is not specified in the design file, the IN/PD pin will be configured as a regular logic input.

Note: Some programmers list the 22V10 JEDEC-compatible 22V10C (no PD used) separately from the non-22V10 JEDEC-compatible 22V10CEX (with PD used).

Figure 8-1. Input Diagram

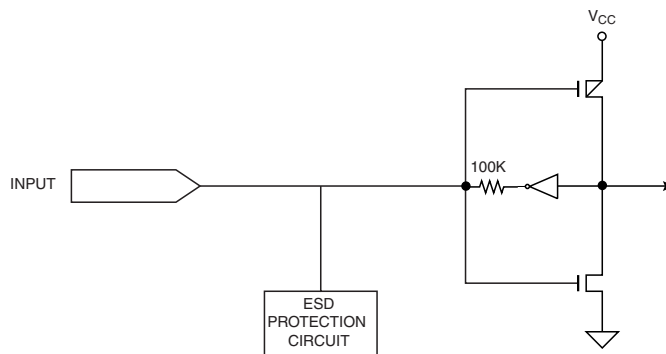
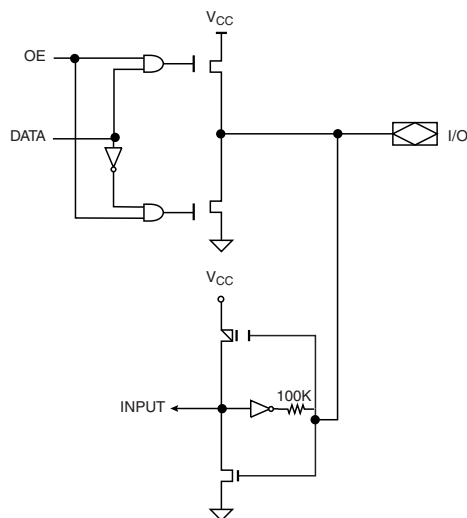

Figure 8-2. I/O Diagram



9. Compiler Mode Selection

Table 9-1. Compiler Mode Selection

	PAL Mode (5828 Fuses)	GAL Mode (5892 Fuses)	Power-down Mode⁽¹⁾ (5893 Fuses)
Synario	Atmel ATF22C10C (DIP) Atmel ATF22V10C (PLCC)	Atmel ATF22C10C DIO (UES) Atmel ATF22V10C PLCC (UES)	Atmel ATF22C10C DIP (PWD) Atmel ATF22C10V PLCC (PWD)
WINCUPL	P22V10 P22V10LCC	G22V10 G22V10LCC	G22V10CP G22V10CPLCC

Note: 1. These device types will create a JEDEC file which when programmed in an Atmel ATF22V10C device will enable the power-down mode feature. All other devices have this feature disabled.

10. Functional Logic Diagram Description

The functional logic diagram describes the Atmel® ATF22LV10C architecture.

The ATF22LV10C has twelve inputs and ten I/O macrocells. Each macrocell can be configured into one of four output configurations: active high/low, registered/combinatorial output. The universal architecture of the ATF22LV10C can be programmed to emulate most 24-pin PAL devices.

Unused product terms are automatically disabled by the compiler to decrease power consumption. A security fuse, when programmed, protects the contents of the ATF22LV10C. Eight bytes (64-fuses) of User Signature are accessible to the user for purposes such as storing project name, part number, revision or date. The User Signature is accessible regardless of the state of the security fuse.

Figure 10-1. Functional Logic Diagram Atmel ATF22LV10C

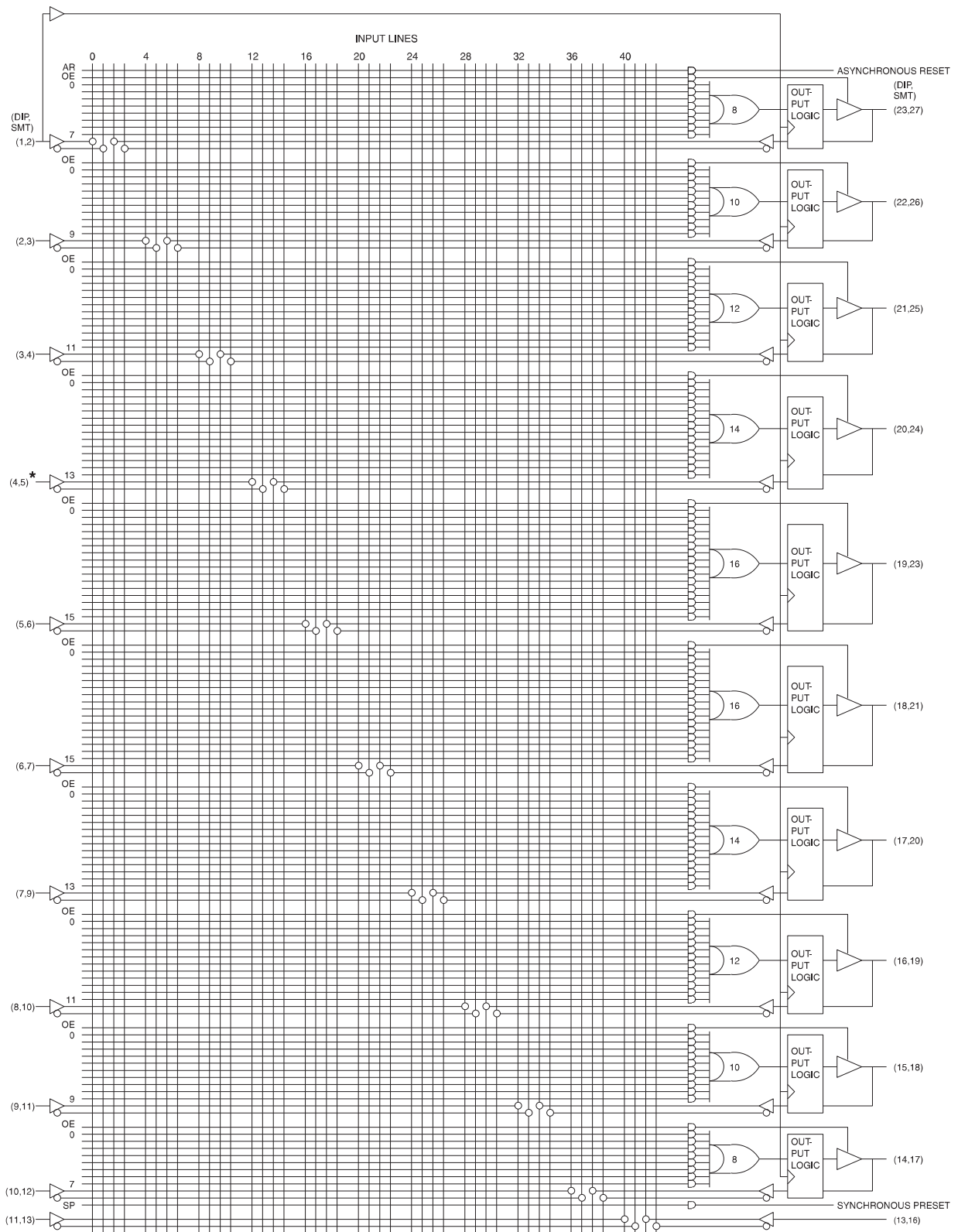

Note: 1. *Input not available if the power-down (PD) option is utilized



**ATMEL ATF22LV10C
SUPPLY CURRENT VS. SUPPLY VOLTAGE ($T_A = 25^\circ\text{C}$)**

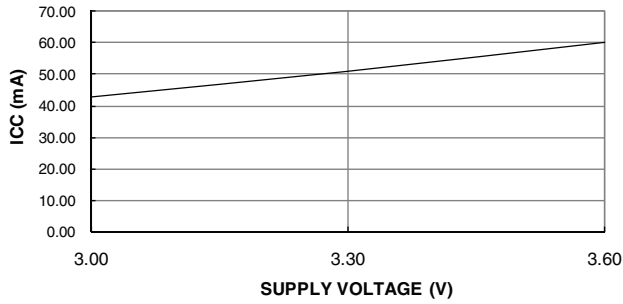

**ATMEL ATF22LV10C
NORMALIZED I_{CC} VS. TEMP.**

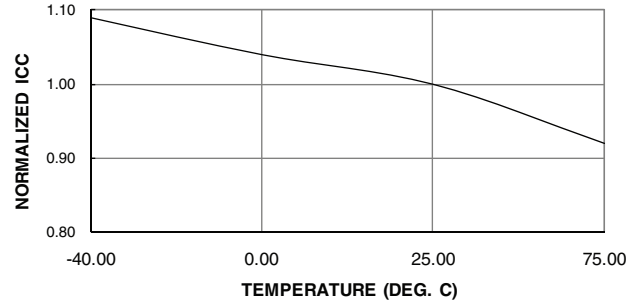

**ATMEL ATF22LV10C SUPPLY CURRENT VS.
INPUT FREQUENCY ($V_{CC} = 3.3\text{V}, T_A = 25^\circ\text{C}$)**

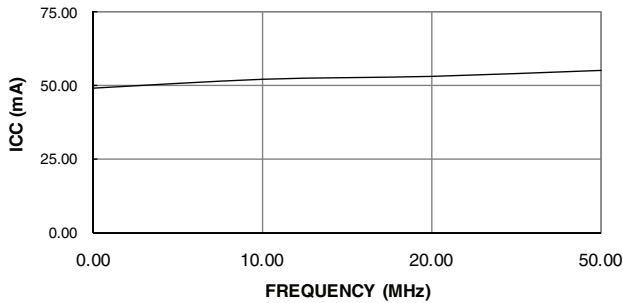

**ATMEL ATF22LV10C OUTPUT SOURCE
CURRENT VS. SUPPLY VOLTAGE ($V_{OH} = 2.4\text{V}$)**

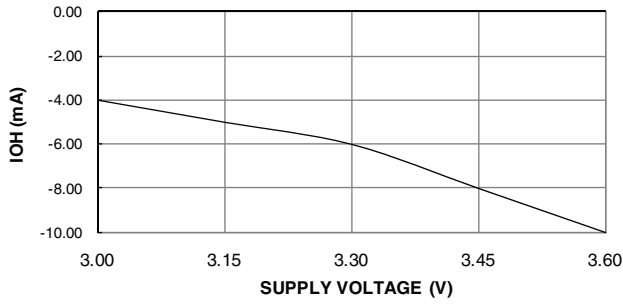

**ATMEL ATF22LV10C OUTPUT SOURCE CURRENT
VS. OUTPUT VOLTAGE ($V_{CC} = 3.3\text{V}, T_A = 25^\circ\text{C}$)**

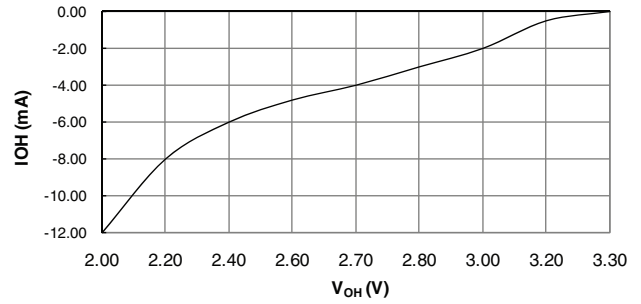

**ATMEL ATF22LV10C
OUTPUT SINK CURRENT VS. SUPPLY VOLTAGE ($V_{OL} = 0.5\text{V}$)**

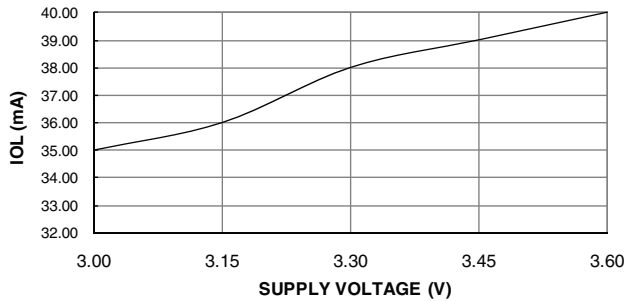

**ATMEL ATF22LV10C OUTPUT SINK CURRENT VS.
OUTPUT VOLTAGE ($V_{CC} = 3.3\text{V}, T_A = 25^\circ\text{C}$)**

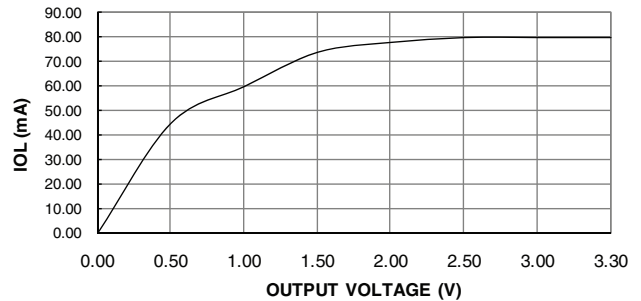

ATMEL ATF22LV10C INPUT CLAMP CURRENT VS. INPUT VOLTAGE ($V_{CC} = 3.3V, T_A = 25^\circ C$)

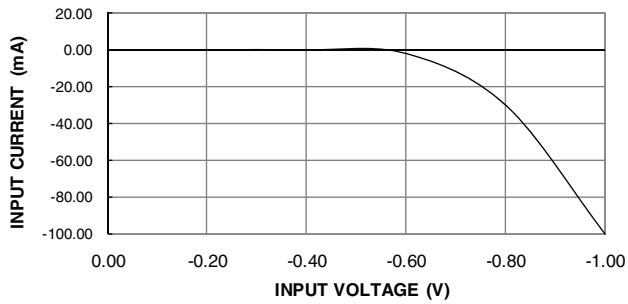

ATMEL ATF22LV10C INPUT CURRENT VS. INPUT VOLTAGE ($V_{CC} = 3.3V, T_A = 25^\circ C$)

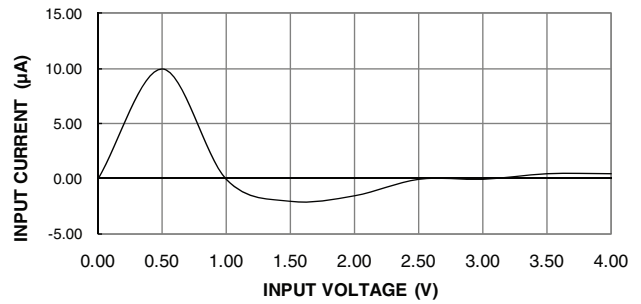

NORMALIZED T_{PD} VS. V_{CC}

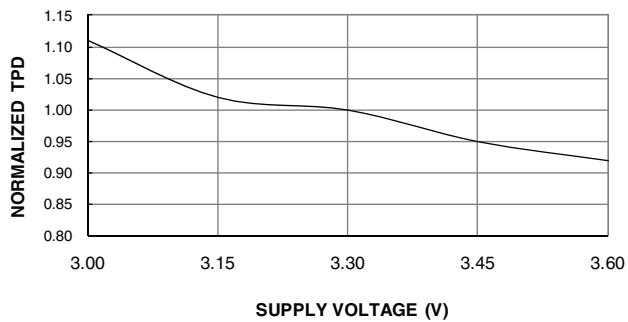

NORMALIZED T_{PD} VS. TEMP

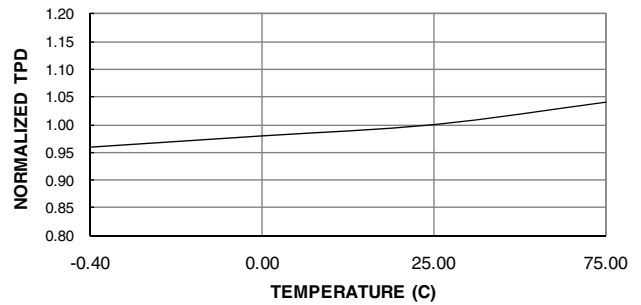

NORMALIZED T_{CO} VS. V_{CC}

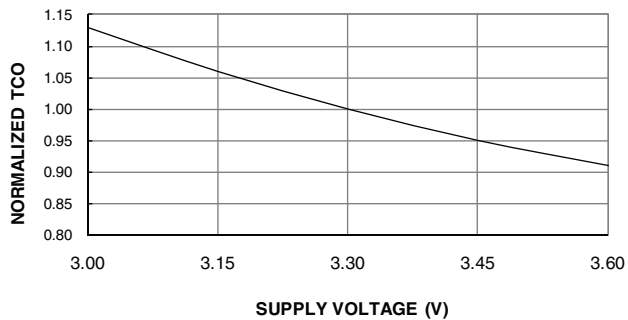

NORMALIZED T_{CO} VS. TEMP

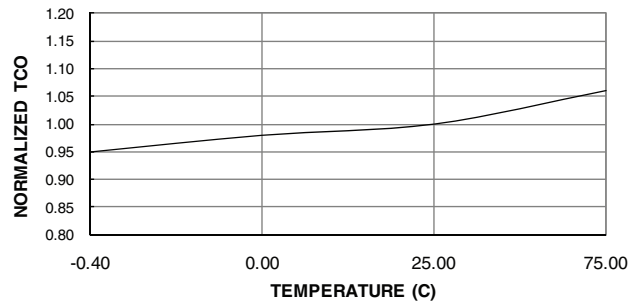

NORMALIZED T_{SU} VS. V_{CC}

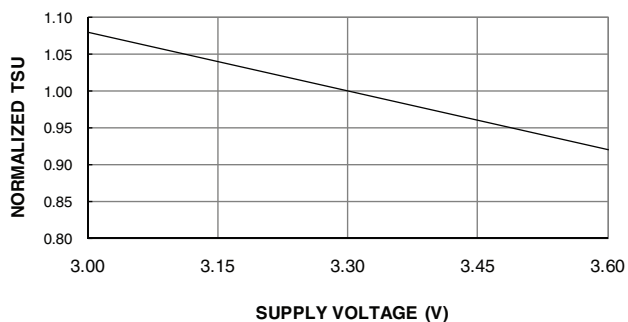

NORMALIZED T_{SU} VS. TEMP

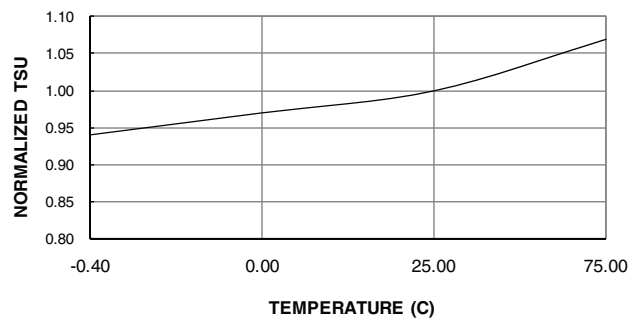

**ATMEL ATF22LV10C
DELTA T_{PD} VS. OUTPUT LOADING**

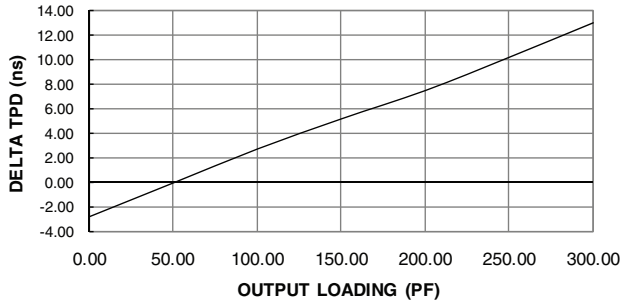

**ATMEL ATF22LV10C
DELTA T_{CO} VS. OUTPUT LOADING**

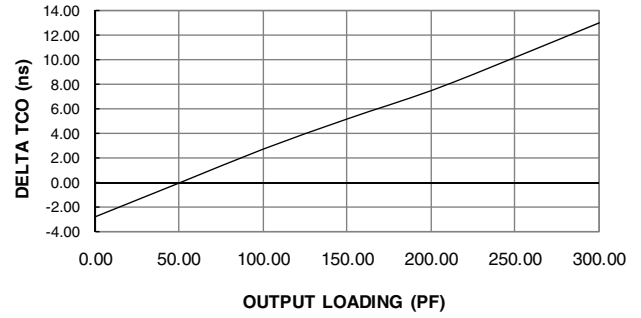

**ATMEL ATF22LV10C DELTA T_{PD} VS.
NUMBER OF OUTPUT SWITCHING**

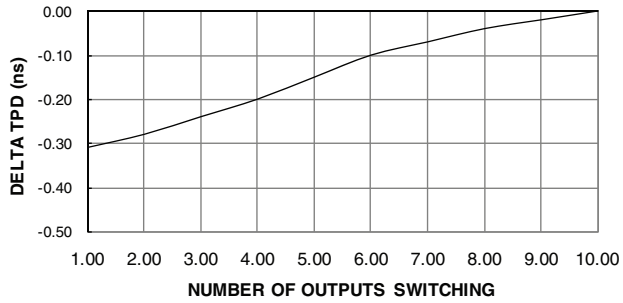

**ATMEL ATF22LV10C DELTA T_{CO} VS.
NUMBER OF OUTPUT SWITCHING**

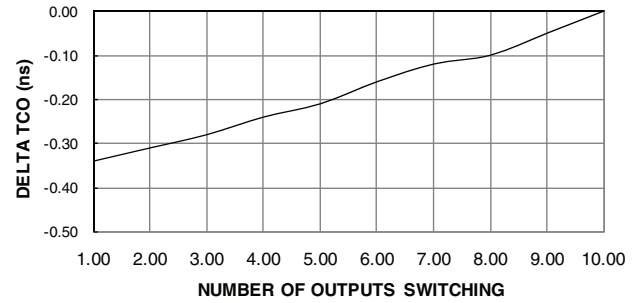

11. Ordering Information

11.1 Ordering Code Detail

t_{PD} (ns)	t_S (ns)	t_{CO} (ns)	Ordering Code	Package	Operation Range
10	7.5	7.5	ATF22LV10C-10JC	28J	Commercial (0°C to 70°C)
			ATF22LV10C-10PC	24P3	
			ATF22LV10C-10SC	24S	
			ATF22LV10C-10XC	24X	
10	7.5	7.5	ATF22LV10C-10JI	28J	Industrial (0°C to 85°C)
			ATF22LV10C-10PI	24P3	
			ATF22LV10C-10SI	24S	
			ATF22LV10C-10XI	24X	
15	12	10	ATF22LV10C-15JC	28J	Commercial (0°C to 70°C)
			ATF22LV10C-15PC	24P3	
			ATF22LV10C-15SC	24S	
			ATF22LV10C-15XC	24X	
15	12	10	ATF22LV10C-15JI	28J	Industrial (-40°C to +85°C)
			ATF22LV10C-15PI	24P3	
			ATF22LV10C-15SI	24S	
			ATF22LV10C-15XI	24X	

Note: Lead based packages will become obsolete, and are not recommended for new designs

11.2 Green Package Options (Pb/Halide-free/RoHS Compliant)

t_{PD} (ns)	t_S (ns)	t_{CO} (ns)	Ordering Code	Package	Operation Range
10	7.5	7.5	ATF22LV10C-10JU	28J	Industrial (0°C to +85°C)
			ATF22LV10C-10PU	24P3	
			ATF22LV10C-10SU	24S	
			ATF22LV10C-10XU	24X	

11.3 Using “C” Product for Industrial

To use commercial product for industrial temperature ranges, simply de-rate I_{CC} by 15% on the “C” device. No speed de-rating is necessary.

Package Type	
28J	28-lead, Plastic J-leaded Chip Carrier (PLCC)
24P3	24-lead, 0.300" Wide, Plastic Dual In-line Package (PDIP)
24S	24-lead, 0.300" Wide, Plastic Gull Wing Small Outline (SOIC)
24X	24-lead, 4.4mm Wide, Plastic Thin Shrink Small Outline (TSSOP)

12. Package Information

12.1 28J – PLCC

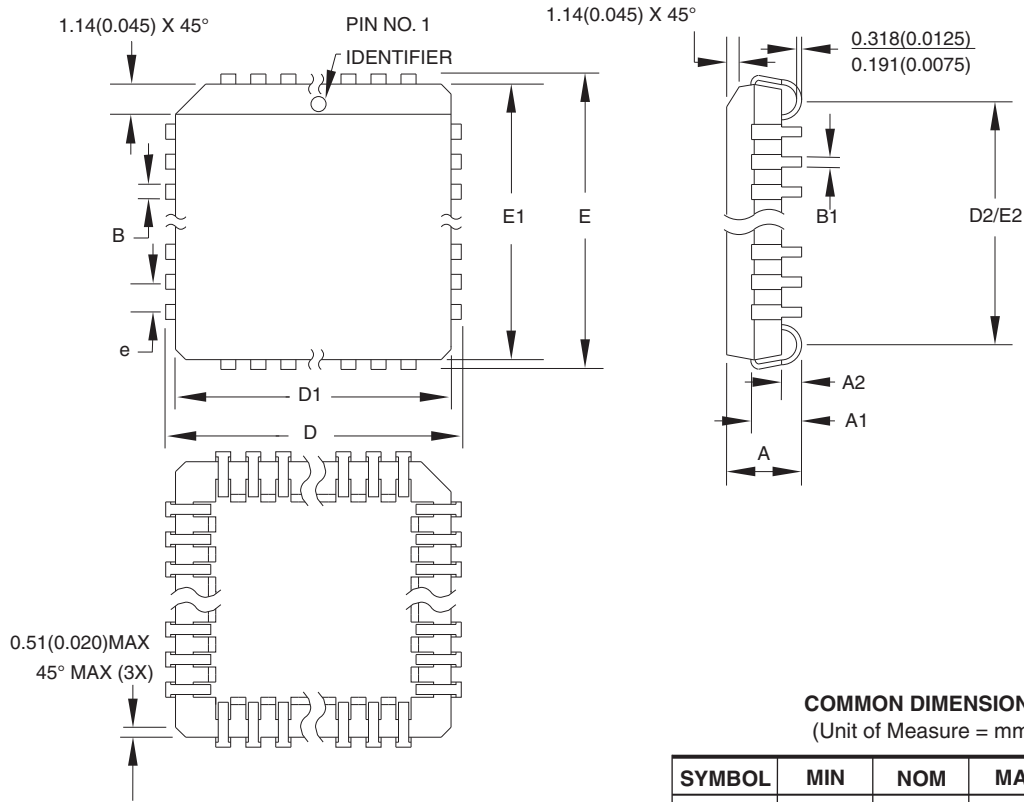

COMMON DIMENSIONS
(Unit of Measure = mm)

SYMBOL	MIN	NOM	MAX	NOTE
A	4.191	–	4.572	
A1	2.286	–	3.048	
A2	0.508	–	–	
D	12.319	–	12.573	
D1	11.430	–	11.582	Note 2
E	12.319	–	12.573	
E1	11.430	–	11.582	Note 2
D2/E2	9.906	–	10.922	
B	0.660	–	0.813	
B1	0.330	–	0.533	
e	1.270 TYP			

- Notes:
1. This package conforms to JEDEC reference MS-018, Variation AB.
 2. Dimensions D1 and E1 do not include mold protrusion. Allowable protrusion is .010" (0.254mm) per side. Dimension D1 and E1 include mold mismatch and are measured at the extreme material condition at the upper or lower parting line.
 3. Lead coplanarity is 0.004" (0.102mm) maximum.

10/04/01



Package Drawing Contact:
packagedrawings@atmel.com

TITLE

28J, 28-lead, Plastic J-leded Chip Carrier (PLCC)

DRAWING NO.

28J

REV.

B

12.2 24P3 – PDIP

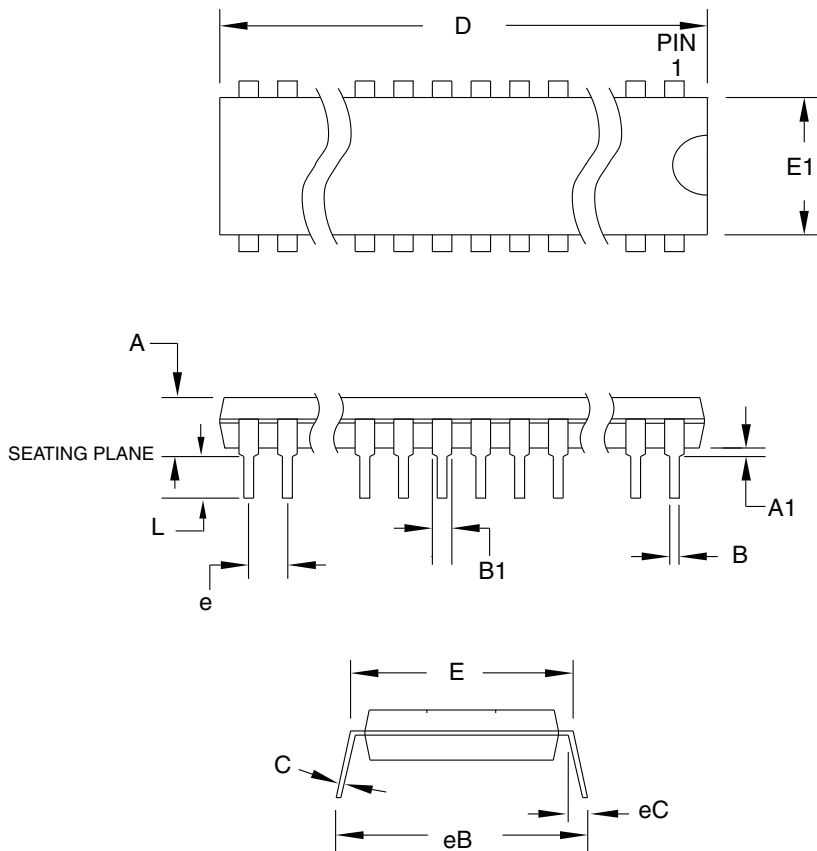

COMMON DIMENSIONS
(Unit of Measure = mm)

SYMBOL	MIN	NOM	MAX	NOTE
A	–	–	5.334	
A1	0.381	–	–	
D	31.623	–	32.131	Note 2
E	7.620	–	8.255	
E1	6.096	–	7.112	Note 2
B	0.356	–	0.559	
B1	1.270	–	1.651	
L	2.921	–	3.810	
C	0.203	–	0.356	
eB	–	–	10.922	
eC	0.000	–	1.524	
e	2.540 TYP			

- Notes:
1. This package conforms to JEDEC reference MS-001, Variation AF.
 2. Dimensions D and E1 do not include mold Flash or Protrusion. Mold Flash or Protrusion shall not exceed 0.25mm (0.010").

6/1/04

ATMEL Package Drawing Contact:
packagedrawings@atmel.com

TITLE
24P3, 24-lead (0.300"/7.62mm Wide) Plastic Dual
Inline Package (PDIP)

DRAWING NO.
24P3

REV.
D

12.3 24S – SOIC

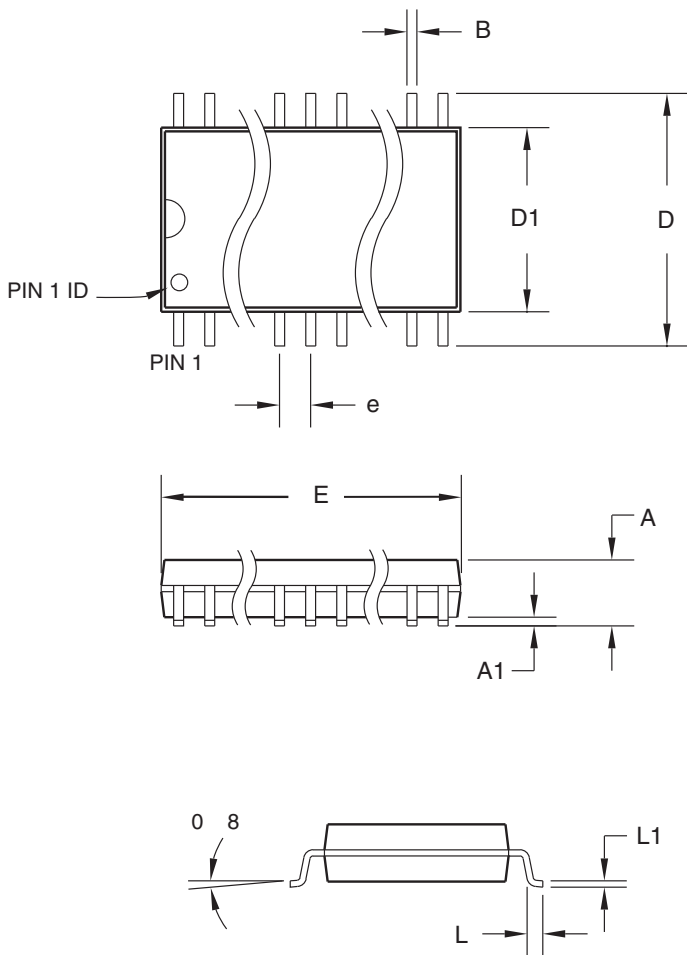

COMMON DIMENSIONS
(Unit of Measure = mm)

SYMBOL	MIN	NOM	MAX	NOTE
A	–	–	2.65	
A1	0.10	–	0.30	
D	10.00	–	10.65	
D1	7.40	–	7.60	
E	15.20	–	15.60	
B	0.33	–	0.51	
L	0.40	–	1.27	
L1	0.23	–	0.32	
e	1.27 BSC			

06/17/2002



Package Drawing Contact:
packagedrawings@atmel.com

TITLE

24S, 24-lead (0.300" body) Plastic Gull Wing Small Outline (SOIC)

DRAWING NO.

24S

REV.

B

12.4 24X – TSSOP

Dimensions in Millimeter and (Inches)*
 JEDEC STANDARD MO-153 AD
 Controlling dimension: millimeters

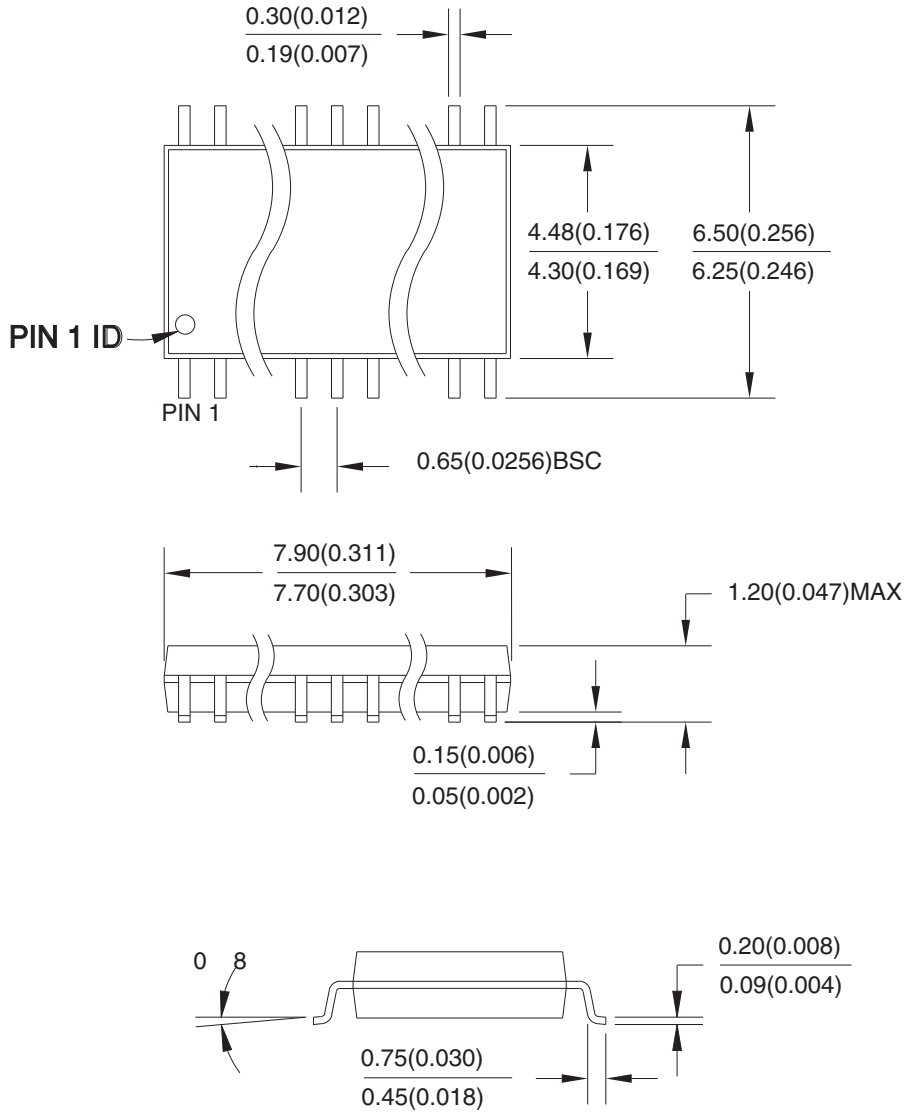

04/11/2001



Package Drawing Contact:
 packagedrawings@atmel.com

TITLE

24X, 24-lead (4.4mm body width) Plastic Thin Shrink
 Small Outline Package (TSSOP)

DRAWING NO.

24X

REV.

A



13. Revision History

Doc. Rev.	Date	Comments
0780M	07/2010	Update the standby current parameters for Powerdown mode from 100 μ A to 120 μ A. Shade Ordering Package Option table and add note, "Lead based packages will become obsolete and are not recommended for new designs."
0780L	12/2005	Add Green Package options



Headquarters

Atmel Corporation
2325 Orchard Parkway
San Jose, CA 95131
USA
Tel: (+1)(408) 441-0311
Fax: (+1)(408) 487-2600
www.atmel.com

International

Atmel Asia Limited
Unit 01-5 & 16, 19/F
BEA Tower, Millennium City 5
418 Kwun Tong Road
Kwun Tong, Kowloon
HONG KONG
Tel: (+852) 2245-6100
Fax: (+852) 2722-1369

Atmel Munich GmbH
Business Campus
Parkring 4
D-85748 Garching b. Munich
GERMANY
Tel: (+49) 89-31970-0
Fax: (+49) 89-3194621

Atmel Japan
9F, Tonetsu Shinkawa Bldg.
1-24-8 Shinkawa
Chuo-ku, Tokyo 104-0033
JAPAN
Tel: (+81) 3-3523-3551
Fax: (+81) 3-3523-7581

Product Contact

Technical Support
pld@atmel.com

Sales Contact
www.atmel.com/contacts

Literature Requests
www.atmel.com/literature

Disclaimer: The information in this document is provided in connection with Atmel products. No license, express or implied, by estoppel or otherwise, to any intellectual property right is granted by this document or in connection with the sale of Atmel products. **EXCEPT AS SET FORTH IN ATMEL'S TERMS AND CONDITIONS OF SALE LOCATED ON ATMEL'S WEB SITE, ATMEL ASSUMES NO LIABILITY WHATSOEVER AND DISCLAIMS ANY EXPRESS, IMPLIED OR STATUTORY WARRANTY RELATING TO ITS PRODUCTS INCLUDING, BUT NOT LIMITED TO, THE IMPLIED WARRANTY OF MERCHANTABILITY, FITNESS FOR A PARTICULAR PURPOSE, OR NON-INFRINGEMENT. IN NO EVENT SHALL ATMEL BE LIABLE FOR ANY DIRECT, INDIRECT, CONSEQUENTIAL, PUNITIVE, SPECIAL OR INCIDENTAL DAMAGES (INCLUDING, WITHOUT LIMITATION, DAMAGES FOR LOSS OF PROFITS, BUSINESS INTERRUPTION, OR LOSS OF INFORMATION) ARISING OUT OF THE USE OR INABILITY TO USE THIS DOCUMENT, EVEN IF ATMEL HAS BEEN ADVISED OF THE POSSIBILITY OF SUCH DAMAGES.** Atmel makes no representations or warranties with respect to the accuracy or completeness of the contents of this document and reserves the right to make changes to specifications and product descriptions at any time without notice. Atmel does not make any commitment to update the information contained herein. Unless specifically provided otherwise, Atmel products are not suitable for, and shall not be used in, automotive applications. Atmel's products are not intended, authorized, or warranted for use as components in applications intended to support or sustain life.

© Atmel Corporation 2010. All rights reserved.

Atmel®, logo and combinations thereof, Everywhere You Are® and others, are registered trademarks or trademarks of Atmel Corporation or its subsidiaries. Other terms and product names may be trademarks of others.

Looking for pricing, stock, or lifecycle information?

Click below to explore more details on WIN SOURCE:

 [View ATF22LV10C-10PC on WIN SOURCE](#)

 [Atmel Information](#)

Optimize Your Supply Chain with WIN SOURCE Solutions

-  Global Sourcing Solution
-  Obsolete Management
-  Cost Control Management
-  Shortage Management
-  Alternative Solution
-  Excess Inventory Management