

BGU7032

1 GHz wideband low-noise amplifier with bypass

Rev. 2 — 14 September 2010

Product data sheet

1. Product profile

1.1 General description

The BGU7032 MMIC is a wideband amplifier with bypass mode. It is designed specifically for high linearity, low-noise applications over a frequency range of 40 MHz to 1 GHz. It is especially suited to Set-Top Box applications.

The LNA is housed in a 6-pin SOT363 plastic SMD package.

CAUTION



This device is sensitive to ElectroStatic Discharge (ESD). Therefore care should be taken during transport and handling.

1.2 Features and benefits

- Internally biased
- Programmable between $G_p = 10$ dB and bypass
- Flat gain between 40 MHz and 1 GHz
- Noise figure of 4.5 dB
- High linearity with an $IP3_O$ of 29 dBm
- 75Ω input and output impedance
- Power-down during bypass mode
- Bypass mode current consumption < 5 mA
- ESD protection > 2 kV Human Body Model (HBM) on all pins

1.3 Applications

- Terrestrial and cable Set-Top Boxes (STB)
- Silicon and “Can” tuners
- Personal and Digital Video Recorders (PVR and DVR)
- Home networking and in-house signal distribution



1.4 Quick reference data

Table 1. Quick reference data

$T_{amb} = 25\text{ }^{\circ}\text{C}$; typical values at $V_{CC} = 5\text{ V}$; $Z_S = Z_L = 75\text{ }\Omega$; $R_{bias} = 43\text{ }\Omega$; $40\text{ MHz} \leq f_1 \leq 1000\text{ MHz}$.

Symbol	Parameter	Conditions	Min	Typ	Max	Unit
V_{CC}	supply voltage	RF input AC coupled	4.75	5.0	5.25	V
$I_{CC(tot)}$	total supply current	$G_p = 10\text{ dB}$ mode	[1]	-	43	- mA
		bypass mode	[1]	-	4	- mA
T_{amb}	ambient temperature		-10	-	+70	$^{\circ}\text{C}$
NF	noise figure	$G_p = 10\text{ dB}$ mode	[1]	-	4.5	- dB
		bypass mode	[1]	-	2.5	- dB
$P_{L(1dB)}$	output power at 1 dB gain compression	1 GHz; $G_p = 10\text{ dB}$ mode	[1]	-	14	- dBm
IP3O	output third-order intercept point	$G_p = 10\text{ dB}$ mode	[1][2]	-	29	- dBm

[1] Mode depends on setting of V_{CTRL} ; see Table 8.

[2] The fundamental frequency (f_1) is 1000 MHz. The intermodulation product (IM3) is $2 \times f_2 - f_1$, where $f_2 = f_1 \pm 1\text{ MHz}$. Input power $P_i = -10\text{ dBm}$.

2. Pinning information

Table 2. Pinning

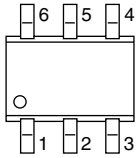
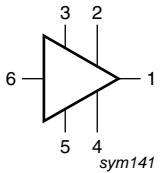
Pin	Description	Simplified outline	Graphic symbol
1	RF_OUT		
2	V_{CC}		
3	n.c.		
4	CTRL		
5	GND		
6	RF_IN		

3. Ordering information

Table 3. Ordering information

Type number	Package		Version
	Name	Description	
BGU7032	-	plastic surface-mounted package; 6 leads	SOT363

4. Marking

Table 4. Marking codes

Type number	Marking code
BGU7032	SD%

Note: % character indicates the location of production.

5. Limiting values

Table 5. Limiting values

In accordance with the Absolute Maximum Rating System (IEC 60134).

Symbol	Parameter	Conditions	Min	Max	Unit
V_{CC}	supply voltage	RF input AC coupled	-0.6	5.25	V
$V_{ctrl(Gp)}$	power gain control voltage	pin CTRL	[1] 0	V_{CC}	V
$I_{CC(tot)}$	total supply current		-	60	mA
P_{tot}	total power dissipation	$T_{sp} \leq 100\text{ °C}$	[2] -	250	mW
P_i	input power	single tone	-	10	dBm
T_{stg}	storage temperature		-65	+150	°C
T_j	junction temperature		-	150	°C
T_{amb}	ambient temperature		-10	+70	°C
V_{ESD}	electrostatic discharge voltage	Human Body Model (HBM); according to JEDEC standard 22-A114E	2	-	kV

[1] $V_{ctrl(Gp)}$ must not exceed V_{CC} ; I_{CTRL} must be limited to 5 mA (maximum).

[2] T_{sp} is the temperature at the solder point of the ground lead.

Remark: $V_{ctrl(Gp)}$ must not exceed V_{CC} ; I_{CTRL} must be limited to a maximum of 5 mA.

6. Thermal characteristics

Table 6. Thermal characteristics

Symbol	Parameter	Conditions	Typ	Unit
$R_{th(j-sp)}$	thermal resistance from junction to solder point		240	K/W

7. Characteristics

Table 7. Characteristics

$T_{amb} = 25\text{ °C}$; typical values at $V_{CC} = 5\text{ V}$; $Z_S = Z_L = 75\ \Omega$; $R_{bias} = 43\ \Omega$; $40\text{ MHz} \leq f_1 \leq 1000\text{ MHz}$.

Symbol	Parameter	Conditions	Min	Typ	Max	Unit
V_{CC}	supply voltage	RF input AC coupled	4.75	5.0	5.25	V
$I_{CC(tot)}$	total supply current	$G_p = 10\text{ dB mode}$	[1] -	43	-	mA
		bypass mode	[1] -	4	-	mA
$ S_{21} ^2$	insertion power gain	$G_p = 10\text{ dB mode}$	[1] -	10	-	dB
		bypass mode	[1] -	-2	-	dB
SL_{sl}	slope straight line		-	-1	-	dB
FL	flatness of frequency response		-	-0.2	-	dB
NF	noise figure	$G_p = 10\text{ dB mode}$	[1] -	4.5	-	dB
		bypass mode	[1] -	2.5	-	dB
RL_{in}	input return loss	$G_p = 10\text{ dB mode}$	[1] -	18	-	dB
		bypass mode	[1] -	8	-	dB

Table 7. Characteristics ...continued

$T_{amb} = 25\text{ }^{\circ}\text{C}$; typical values at $V_{CC} = 5\text{ V}$; $Z_S = Z_L = 75\text{ }\Omega$; $R_{bias} = 43\text{ }\Omega$; $40\text{ MHz} \leq f_1 \leq 1000\text{ MHz}$.

Symbol	Parameter	Conditions	Min	Typ	Max	Unit
RL _{out}	output return loss	G _p = 10 dB mode	[1]	-	12	- dB
		bypass mode	[1]	-	8	- dB
P _{L(1dB)}	output power at 1 dB gain compression	1 GHz; G _p = 10 dB mode	[1]	-	14	- dBm
IP3 _O	output third-order intercept point	G _p = 10 dB mode	[1][2]	-	29	- dBm
		bypass mode	[1][2]	-	29	- dBm

[1] Mode depends on setting of V_{ctrl(Gp)} (V_{CTRL}); see [Table 8](#).

[2] The fundamental frequency (f₁) is 1000 MHz. The intermodulation product (IM3) is 2 × f₂ – f₁, where f₂ = f₁ ± 1 MHz. Input power P_i = –10 dBm.

Table 8. Gain selection (pin CTRL)

–10 °C ≤ T_{amb} ≤ +70 °C; recommended power-up condition: V_{CTRL} = logic 0 or < 0.7 V.

V _{ctrl(Gp)} (V _{CTRL}) (V)	Mode
≤ 0.7	bypass
≥ 4.3	G _p = 10 dB

Remark: V_{ctrl(Gp)} must not exceed V_{CC}; I_{CTRL} must be limited to a maximum of 5 mA.

8. Application information

Other applications are possible. Please contact your local sales representative for more information. Application notes are available on the NXP website.

8.1 Application circuit

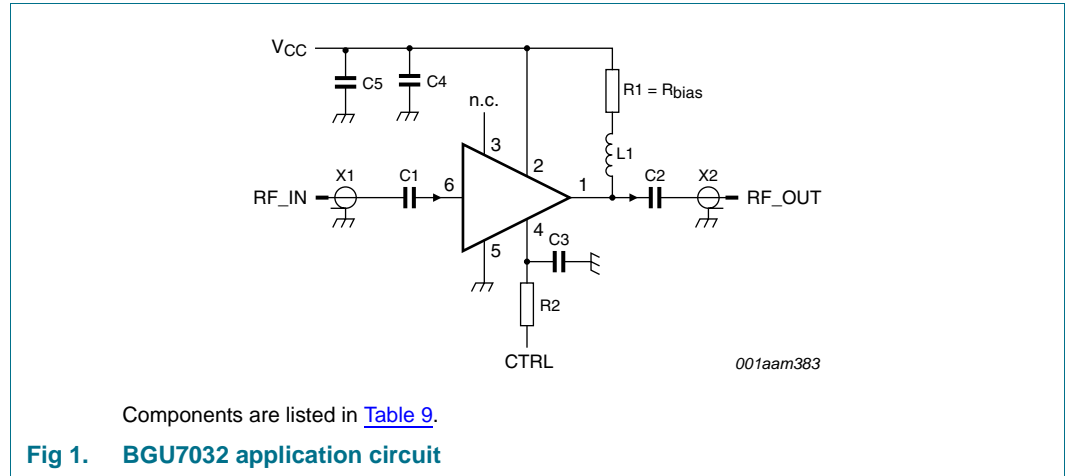

All control and supply lines must be decoupled properly. The decoupling capacitors must be placed as close to the device as possible.

8.2 Application circuit board layout

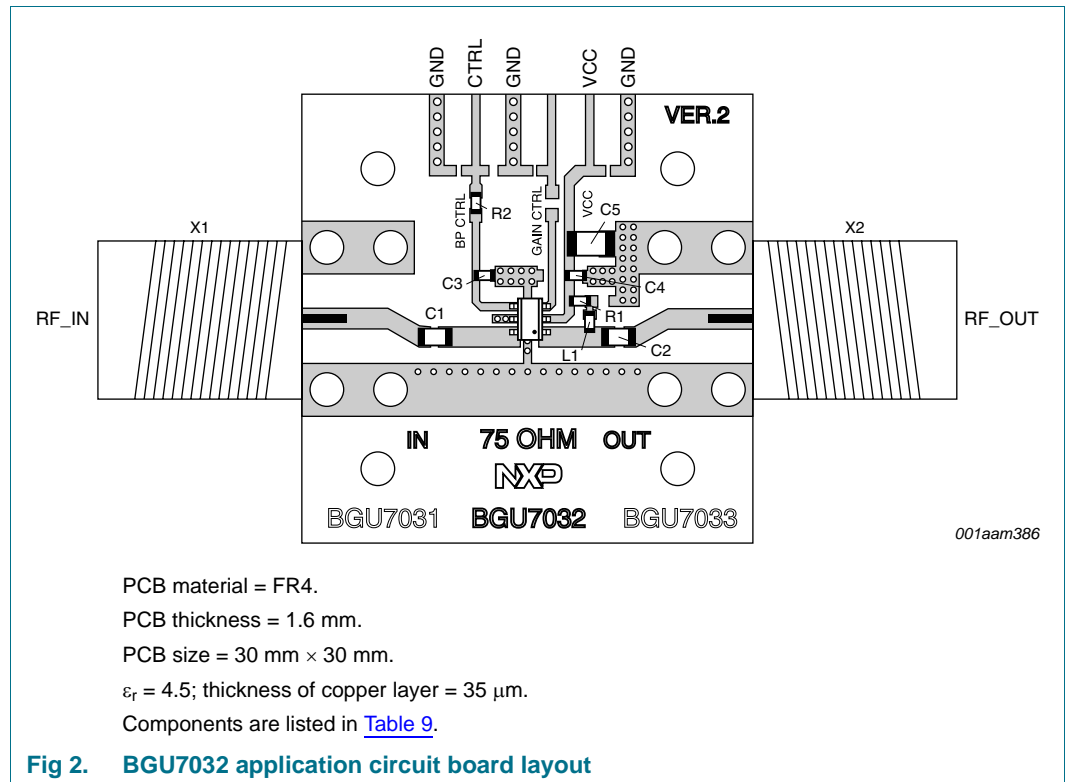

Table 9. List of componentsSee [Figure 1](#) and [Figure 2](#).

Component	Description	Value	Remarks	Function
C1, C2	capacitor	10 nF		DC blocking
C3, C4	capacitor	10 nF		decoupling
C5	capacitor	10 μ F		decoupling
L1	chip ferrite bead	1.5 k Ω	[1] Murata BLM18HE152SN1DF	RF choke
R1	resistor	43 Ω	[1] R _{bias}	bias setting
R2	resistor	1.8 k Ω		current limiting
X1, X2	connector	75 Ω	F-connector, edge mount PCB reflow type, Bomar 861V509ERG	input/output

[1] L1 and R1 must have a power rating of 0.1 W or higher.

9. Package outline

Plastic surface-mounted package; 6 leads

SOT363

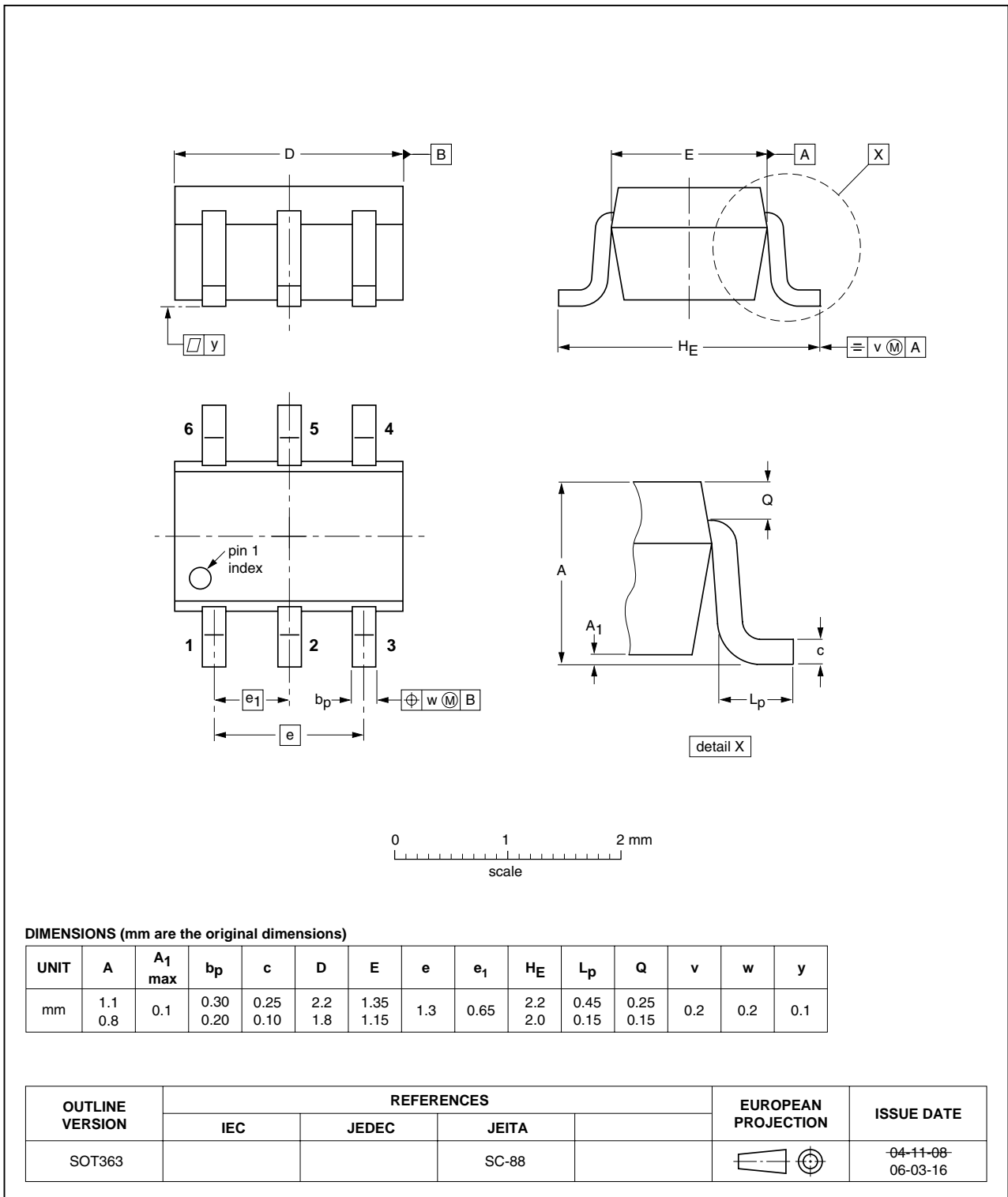

Fig 3. Package outline SOT363

10. Abbreviations

Table 10. Abbreviations

Acronym	Description
AC	Alternating Current
DC	Direct Current
LNA	Low-Noise Amplifier
MMIC	Monolithic Microwave Integrated Circuit
PCB	Printed-Circuit Board
RF	Radio Frequency
SMD	Surface-Mounted Device

11. Revision history

Table 11. Revision history

Document ID	Release date	Data sheet status	Change notice	Supersedes
BGU7032 v.2	20100914	Product data sheet	-	BGU7032 v.1
Modifications:	• The status of this data sheet has been changed to Product data sheet.			
BGU7032 v.1	20100817	Preliminary data sheet	-	-

12. Legal information

12.1 Data sheet status

Document status ^{[1][2]}	Product status ^[3]	Definition
Objective [short] data sheet	Development	This document contains data from the objective specification for product development.
Preliminary [short] data sheet	Qualification	This document contains data from the preliminary specification.
Product [short] data sheet	Production	This document contains the product specification.

[1] Please consult the most recently issued document before initiating or completing a design.

[2] The term 'short data sheet' is explained in section "Definitions".

[3] The product status of device(s) described in this document may have changed since this document was published and may differ in case of multiple devices. The latest product status information is available on the Internet at URL <http://www.nxp.com>.

12.2 Definitions

Draft — The document is a draft version only. The content is still under internal review and subject to formal approval, which may result in modifications or additions. NXP Semiconductors does not give any representations or warranties as to the accuracy or completeness of information included herein and shall have no liability for the consequences of use of such information.

Short data sheet — A short data sheet is an extract from a full data sheet with the same product type number(s) and title. A short data sheet is intended for quick reference only and should not be relied upon to contain detailed and full information. For detailed and full information see the relevant full data sheet, which is available on request via the local NXP Semiconductors sales office. In case of any inconsistency or conflict with the short data sheet, the full data sheet shall prevail.

Product specification — The information and data provided in a Product data sheet shall define the specification of the product as agreed between NXP Semiconductors and its customer, unless NXP Semiconductors and customer have explicitly agreed otherwise in writing. In no event however, shall an agreement be valid in which the NXP Semiconductors product is deemed to offer functions and qualities beyond those described in the Product data sheet.

12.3 Disclaimers

Limited warranty and liability — Information in this document is believed to be accurate and reliable. However, NXP Semiconductors does not give any representations or warranties, expressed or implied, as to the accuracy or completeness of such information and shall have no liability for the consequences of use of such information.

In no event shall NXP Semiconductors be liable for any indirect, incidental, punitive, special or consequential damages (including - without limitation - lost profits, lost savings, business interruption, costs related to the removal or replacement of any products or rework charges) whether or not such damages are based on tort (including negligence), warranty, breach of contract or any other legal theory.

Notwithstanding any damages that customer might incur for any reason whatsoever, NXP Semiconductors' aggregate and cumulative liability towards customer for the products described herein shall be limited in accordance with the *Terms and conditions of commercial sale* of NXP Semiconductors.

Right to make changes — NXP Semiconductors reserves the right to make changes to information published in this document, including without limitation specifications and product descriptions, at any time and without notice. This document supersedes and replaces all information supplied prior to the publication hereof.

Suitability for use — NXP Semiconductors products are not designed, authorized or warranted to be suitable for use in life support, life-critical or safety-critical systems or equipment, nor in applications where failure or

malfunction of an NXP Semiconductors product can reasonably be expected to result in personal injury, death or severe property or environmental damage. NXP Semiconductors accepts no liability for inclusion and/or use of NXP Semiconductors products in such equipment or applications and therefore such inclusion and/or use is at the customer's own risk.

Applications — Applications that are described herein for any of these products are for illustrative purposes only. NXP Semiconductors makes no representation or warranty that such applications will be suitable for the specified use without further testing or modification.

Customers are responsible for the design and operation of their applications and products using NXP Semiconductors products, and NXP Semiconductors accepts no liability for any assistance with applications or customer product design. It is customer's sole responsibility to determine whether the NXP Semiconductors product is suitable and fit for the customer's applications and products planned, as well as for the planned application and use of customer's third party customer(s). Customers should provide appropriate design and operating safeguards to minimize the risks associated with their applications and products.

NXP Semiconductors does not accept any liability related to any default, damage, costs or problem which is based on any weakness or default in the customer's applications or products, or the application or use by customer's third party customer(s). Customer is responsible for doing all necessary testing for the customer's applications and products using NXP Semiconductors products in order to avoid a default of the applications and the products or of the application or use by customer's third party customer(s). NXP does not accept any liability in this respect.

Limiting values — Stress above one or more limiting values (as defined in the Absolute Maximum Ratings System of IEC 60134) will cause permanent damage to the device. Limiting values are stress ratings only and (proper) operation of the device at these or any other conditions above those given in the Recommended operating conditions section (if present) or the Characteristics sections of this document is not warranted. Constant or repeated exposure to limiting values will permanently and irreversibly affect the quality and reliability of the device.

Terms and conditions of commercial sale — NXP Semiconductors products are sold subject to the general terms and conditions of commercial sale, as published at <http://www.nxp.com/profile/terms>, unless otherwise agreed in a valid written individual agreement. In case an individual agreement is concluded only the terms and conditions of the respective agreement shall apply. NXP Semiconductors hereby expressly objects to applying the customer's general terms and conditions with regard to the purchase of NXP Semiconductors products by customer.

No offer to sell or license — Nothing in this document may be interpreted or construed as an offer to sell products that is open for acceptance or the grant, conveyance or implication of any license under any copyrights, patents or other industrial or intellectual property rights.

Export control — This document as well as the item(s) described herein may be subject to export control regulations. Export might require a prior authorization from national authorities.

Quick reference data — The Quick reference data is an extract of the product data given in the Limiting values and Characteristics sections of this document, and as such is not complete, exhaustive or legally binding.

Non-automotive qualified products — Unless this data sheet expressly states that this specific NXP Semiconductors product is automotive qualified, the product is not suitable for automotive use. It is neither qualified nor tested in accordance with automotive testing or application requirements. NXP Semiconductors accepts no liability for inclusion and/or use of non-automotive qualified products in automotive equipment or applications.

In the event that customer uses the product for design-in and use in automotive applications to automotive specifications and standards, customer (a) shall use the product without NXP Semiconductors' warranty of the

product for such automotive applications, use and specifications, and (b) whenever customer uses the product for automotive applications beyond NXP Semiconductors' specifications such use shall be solely at customer's own risk, and (c) customer fully indemnifies NXP Semiconductors for any liability, damages or failed product claims resulting from customer design and use of the product for automotive applications beyond NXP Semiconductors' standard warranty and NXP Semiconductors' product specifications.

12.4 Trademarks

Notice: All referenced brands, product names, service names and trademarks are the property of their respective owners.

13. Contact information

For more information, please visit: <http://www.nxp.com>

For sales office addresses, please send an email to: salesaddresses@nxp.com

14. Contents

1	Product profile	1
1.1	General description	1
1.2	Features and benefits	1
1.3	Applications	1
1.4	Quick reference data	2
2	Pinning information	2
3	Ordering information	2
4	Marking	2
5	Limiting values	3
6	Thermal characteristics	3
7	Characteristics	3
8	Application information	5
8.1	Application circuit	5
8.2	Application circuit board layout	5
9	Package outline	7
10	Abbreviations	8
11	Revision history	8
12	Legal information	9
12.1	Data sheet status	9
12.2	Definitions	9
12.3	Disclaimers	9
12.4	Trademarks	10
13	Contact information	10
14	Contents	11

Please be aware that important notices concerning this document and the product(s) described herein, have been included in section 'Legal information'.

© NXP B.V. 2010.

All rights reserved.

For more information, please visit: <http://www.nxp.com>



For sales office addresses, please send an email to: salesaddresses@nxp.com

Date of release: 14 September 2010

Document identifier: BGU7032

Looking for pricing, stock, or lifecycle information?

Click below to explore more details on WIN SOURCE:

-  [View BGU7032,115 on WIN SOURCE](#)
-  [NXP / Nexperia Information](#)

Optimize Your Supply Chain with WIN SOURCE Solutions

-  Global Sourcing Solution
-  Obsolete Management
-  Cost Control Management
-  Shortage Management
-  Alternative Solution
-  Excess Inventory Management