



**THE DATASHEET OF  
BAR 63-02V E6327**



**Silicon PIN Diodes**

- PIN diode for high speed switching of RF signals
- Very low forward resistance (low insertion loss)
- Very low capacitance (high isolation)
- For frequencies up to 3GHz
- Pb-free (RoHS compliant) package
- Qualified according AEC Q101<sup>1)</sup>

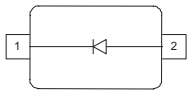
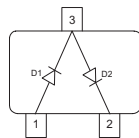
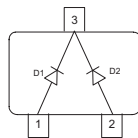
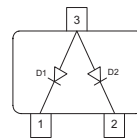
**BAR63-02..**  
**BAR63-03W**

**BAR63-04**  
**BAR63-04W**

**BAR63-05**  
**BAR63-05W**

**BAR63-06**  
**BAR63-06W**

| Type       | Package  | Configuration    | $L_s$ (nH) | Marking |
|------------|----------|------------------|------------|---------|
| BAR63-02L* | TSLP-2-1 | single, leadless | 0.4        | G       |
| BAR63-02V  | SC79     | single           | 0.6        | G       |
| BAR63-02W  | SCD80    | single           | 0.6        | GG      |
| BAR63-03W  | SOD323   | single           | 1.8        | white G |
| BAR63-04   | SOT23    | series           | 1.8        | G4s     |
| BAR63-04W  | SOT323   | series           | 1.4        | G4s     |
| BAR63-05   | SOT23    | common cathode   | 1.8        | G5s     |
| BAR63-05W  | SOT323   | common cathode   | 1.4        | G5s     |
| BAR63-06   | SOT23    | common anode     | 1.8        | G6s     |
| BAR63-06W  | SOT323   | common anode     | 1.4        | G6s     |

<sup>1)</sup>BAR63-02L is not qualified according AEC Q101

**Maximum Ratings** at  $T_A = 25^\circ\text{C}$ , unless otherwise specified

| Parameter  | Symbol           | Value                           | Unit |
|--|------------------|---------------------------------|------|
| Diode reverse voltage  | $V_R$            | 50                              | V    |
| Forward current  | $I_F$            | 100                             | mA   |
| Total power dissipation<br>BAR63-02L, $T_S \leq 118^\circ\text{C}$<br>BAR63-02V, -02W, BAR63-03W, $T_S \leq 115^\circ\text{C}$<br>BAR63-04...BAR63-06, $T_S \leq 55^\circ\text{C}$<br>BAR63-04S, $T_S \leq 115^\circ\text{C}$<br>BAR63-04W...BAR63-06W, $T_S \leq 105^\circ\text{C}$ | $P_{\text{tot}}$ | 250<br>250<br>250<br>250<br>250 | mW   |
| Junction temperature   | $T_j$            | 150                             | °C   |
| Operating temperature range  | $T_{\text{op}}$  | -55 ... 125                     |      |
| Storage temperature  | $T_{\text{stg}}$ | -55 ... 150                     |      |

**Thermal Resistance**

| Parameter   | Symbol            | Value  | Unit |
|---|-------------------|--|------|
| Junction - soldering point <sup>1)</sup><br>BAR63-02L<br>BAR63-02V, BAR63-02W<br>BAR63-03W<br>BAR63-04...BAR63-06<br>BAR63-04S<br>BAR63-04W...BAR63-06W | $R_{\text{thJS}}$ | $\leq 125$<br>$\leq 140$<br>$\leq 155$<br>$\leq 380$<br>$\leq 180$<br>$\leq 180$ | K/W  |

**Electrical Characteristics** at  $T_A = 25^\circ\text{C}$ , unless otherwise specified

| Parameter | Symbol | Values |      |      | Unit |
|-----------|--------|--------|------|------|------|
|           |        | min.   | typ. | max. |      |

**DC Characteristics**

|  |                   |    |      |     |    |
|--|-------------------|----|------|-----|----|
| Breakdown voltage<br>$I_{(\text{BR})} = 5 \mu\text{A}$ | $V_{(\text{BR})}$ | 50 | -    | -   | V  |
| Reverse current<br>$V_R = 35 \text{ V}$                | $I_R$             | -  | -    | 10  | nA |
| Forward voltage<br>$I_F = 100 \text{ mA}$              | $V_F$             | -  | 0.95 | 1.2 | V  |

<sup>1)</sup>For calculation of  $R_{\text{thJA}}$  please refer to the Technical Information

**Electrical Characteristics at  $T_A = 25^\circ\text{C}$ , unless otherwise specified**

| Parameter   | Symbol      | Values      |                     |             | Unit          |
|---|-------------|-------------|---------------------|-------------|---------------|
|   |             | min.        | typ.                | max.        |               |
| <b>AC Characteristics</b>   |             |             |                     |             |               |
| Diode capacitance<br>$V_R = 5\text{ V}$ , $f = 1\text{ MHz}$<br>$V_R = 0\text{ V}$ , 100 MHz ... 1.8 GHz  | $C_T$       | -<br>-      | 0.21<br>0.3         | 0.3<br>-    | pF            |
| Reverse parallel resistance<br>$V_R = 0\text{ V}$ , $f = 100\text{ MHz}$<br>$V_R = 0\text{ V}$ , $f = 1\text{ GHz}$<br>$V_R = 0\text{ V}$ , $f = 1.8\text{ GHz}$        | $R_P$       | -<br>-<br>- | 500<br>15<br>5      | -<br>-<br>- | k $\Omega$    |
| Forward resistance<br>$I_F = 5\text{ mA}$ , $f = 100\text{ MHz}$<br>$I_F = 10\text{ mA}$ , $f = 100\text{ MHz}$   | $r_f$       | -<br>-      | 1.2<br>1            | 2<br>-      | $\Omega$      |
| Charge carrier life time<br>$I_F = 10\text{ mA}$ , $I_R = 6\text{ mA}$ , measured at $I_R = 3\text{ mA}$ ,<br>$R_L = 100\ \Omega$                                       | $\tau_{rr}$ | -           | 75                  | -           | ns            |
| I-region width  | $W_I$       | -           | 4.5                 | -           | $\mu\text{m}$ |
| Insertion loss <sup>1)</sup><br>$I_F = 1\text{ mA}$ , $f = 1.8\text{ GHz}$<br>$I_F = 5\text{ mA}$ , $f = 1.8\text{ GHz}$<br>$I_F = 10\text{ mA}$ , $f = 1.8\text{ GHz}$ | $l_L$       | -<br>-<br>- | 0.15<br>0.11<br>0.1 | -<br>-<br>- | dB            |
| Isolation <sup>1)</sup><br>$V_R = 0\text{ V}$ , $f = 0.9\text{ GHz}$<br>$V_R = 0\text{ V}$ , $f = 1.8\text{ GHz}$<br>$V_R = 0\text{ V}$ , $f = 2.45\text{ GHz}$         | $l_{SO}$    | -<br>-<br>- | 17.9<br>12.3<br>10  | -<br>-<br>- |               |
| Series inductance   | $L_S$       | -           | -                   | -           |               |

<sup>1)</sup>BAR63-02L in series configuration,  $Z = 50\ \Omega$

**Diode capacitance  $C_T = f(V_R)$**

$f = 1\text{MHz} - 1.8\text{GHz}$

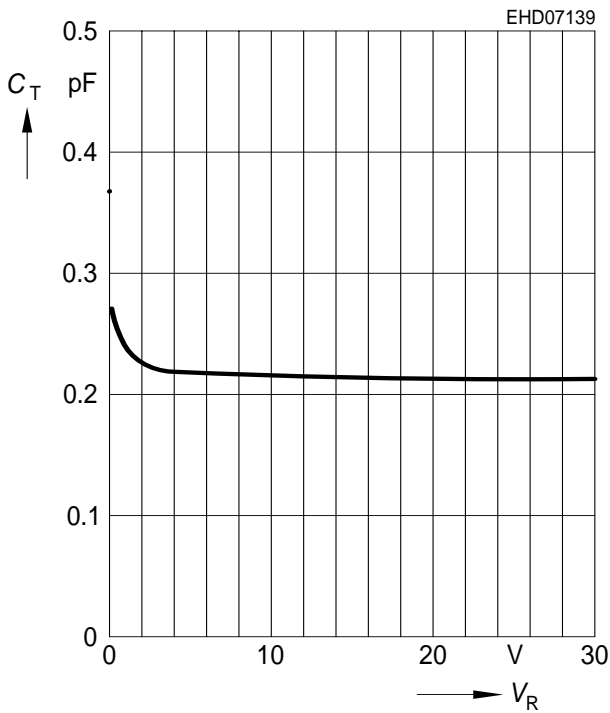

**Reverse parallel resistance  $R_p = f(V_R)$**

$f = \text{Parameter}$

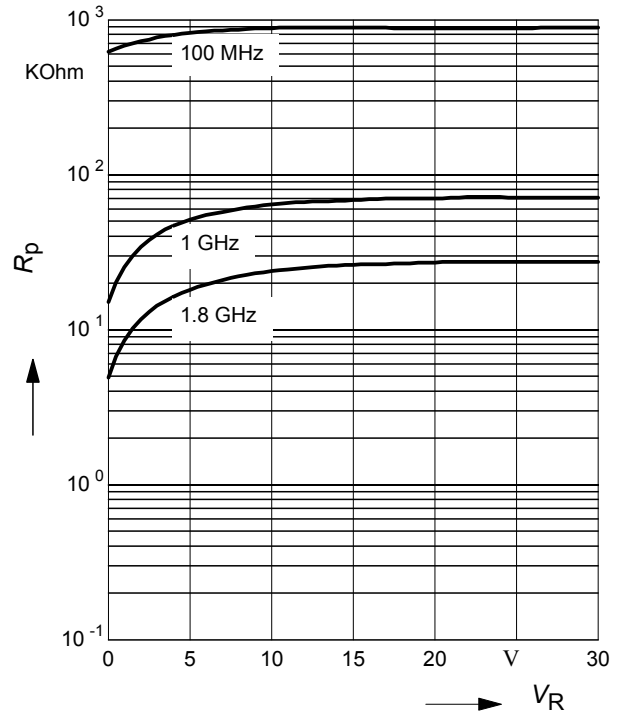

**Forward resistance  $r_f = f(I_F)$**

$f = 100\text{MHz}$

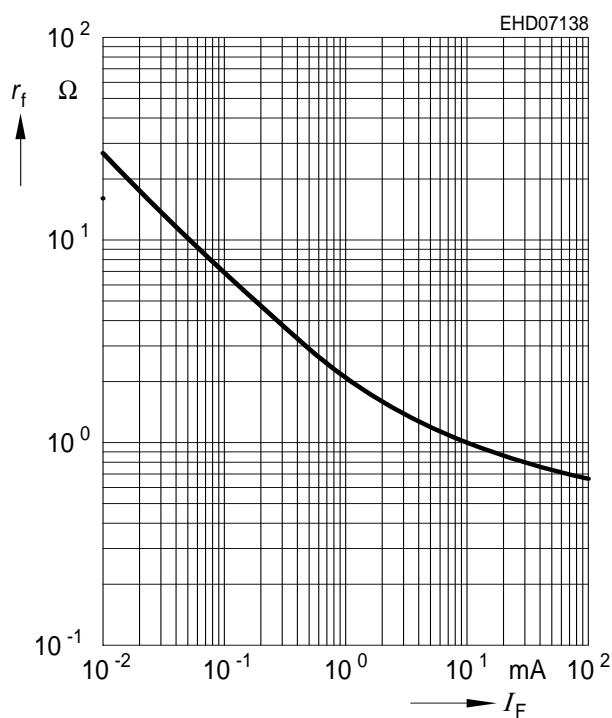

**Forward current  $I_F = f(V_F)$**

$T_A = \text{Parameter}$

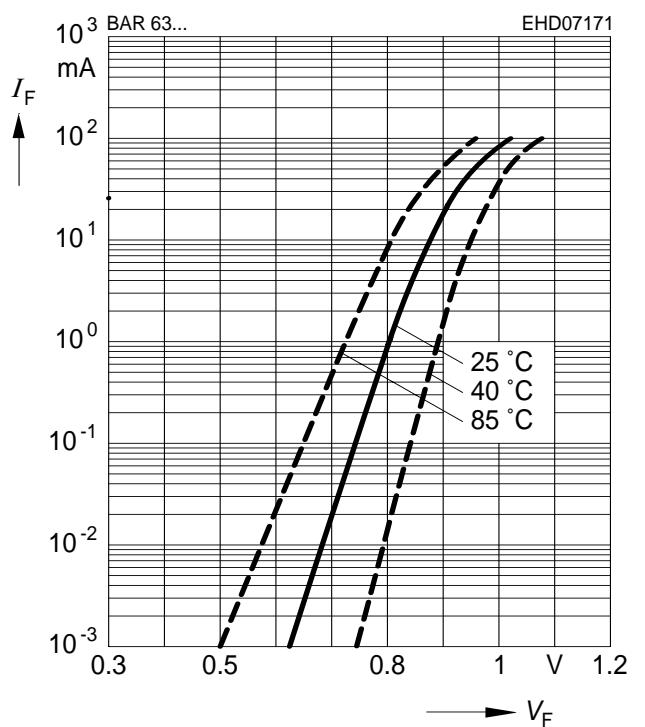

**Forward current  $I_F = f(T_S)$**

BAR63-04...BAR63-06

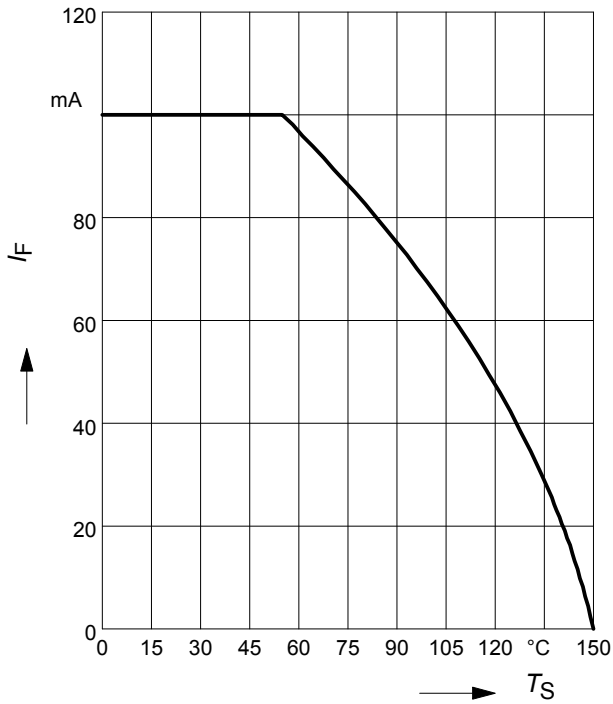

**Forward current  $I_F = f(T_S)$**

BAR63-02V, BAR63-02W

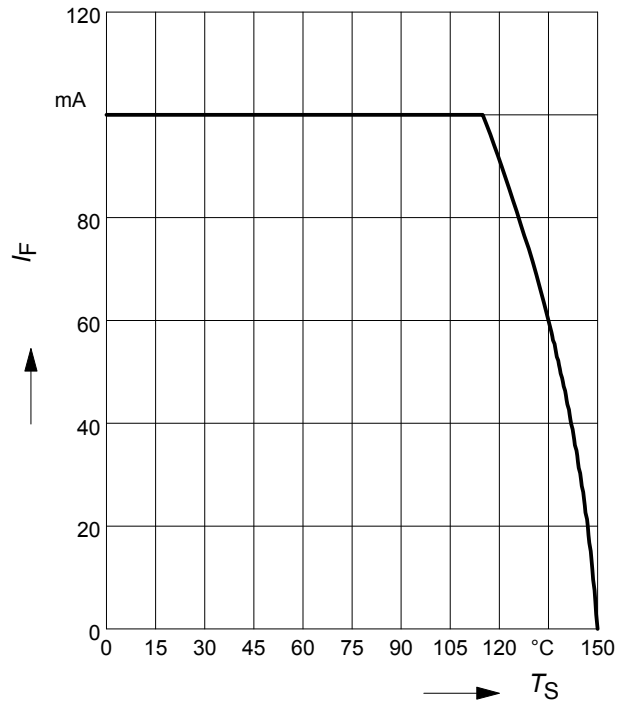

**Forward current  $I_F = f(T_S)$**

BAR63-03W

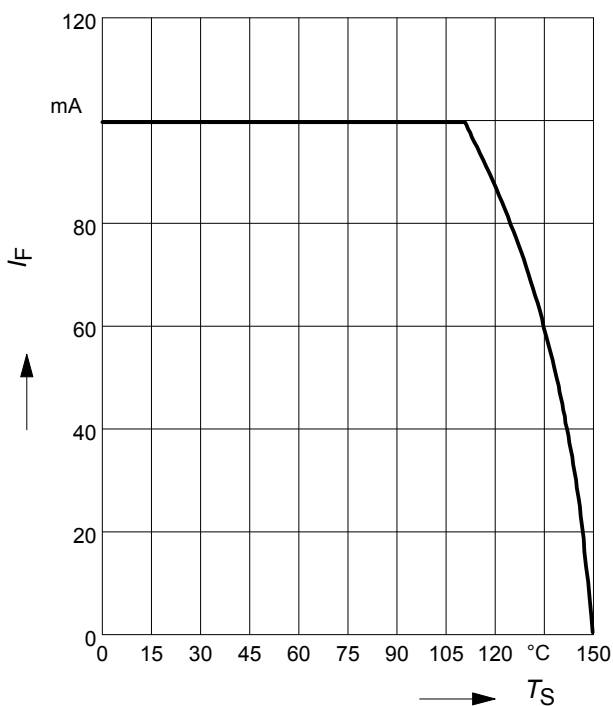

**Forward current  $I_F = f(T_S)$**

BAR63-04W...BAR63-06W

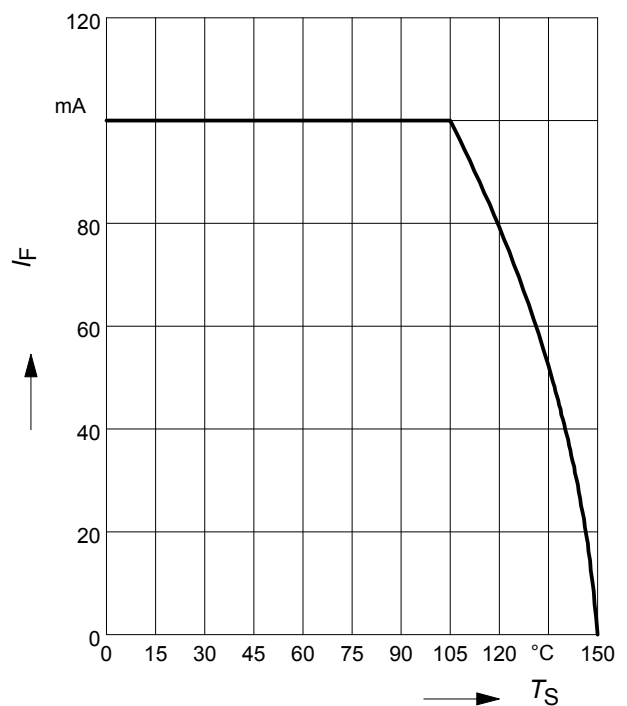

**Permissible Puls Load  $R_{thJS} = f(t_p)$**

BAR63-04...BAR63-06

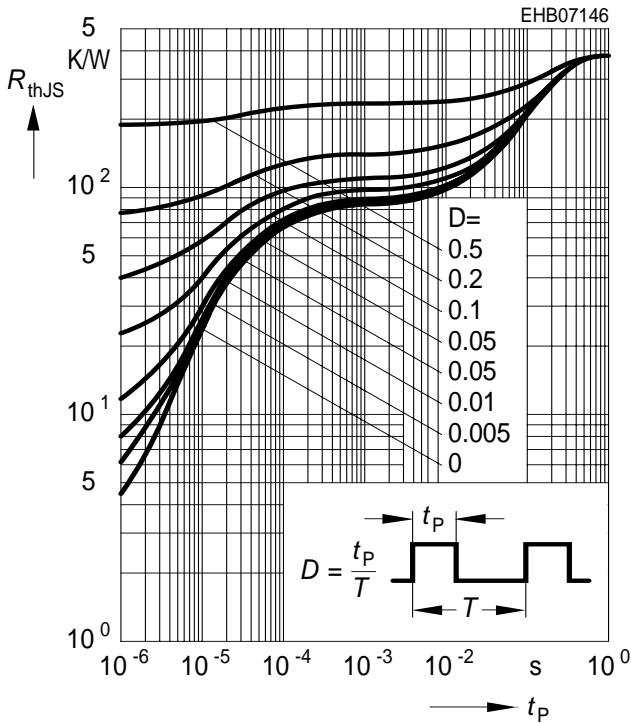

**Permissible Pulse Load**

$I_{Fmax} / I_{FDC} = f(t_p)$

BAR63-04...BAR63-06

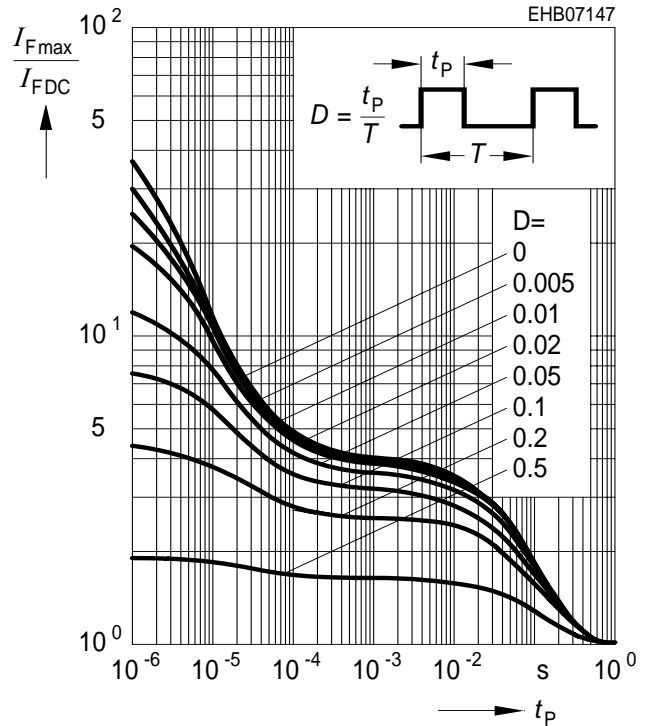

**Permissible Puls Load  $R_{thJS} = f(t_p)$**

BAR63-02V, BAR63-02W

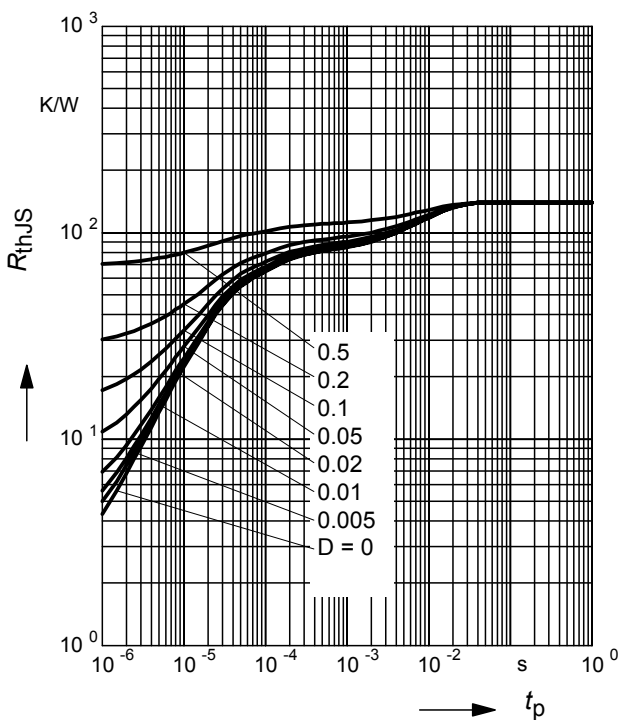

**Permissible Pulse Load**

$I_{Fmax} / I_{FDC} = f(t_p)$

BAR63-02V, BAR63-02W

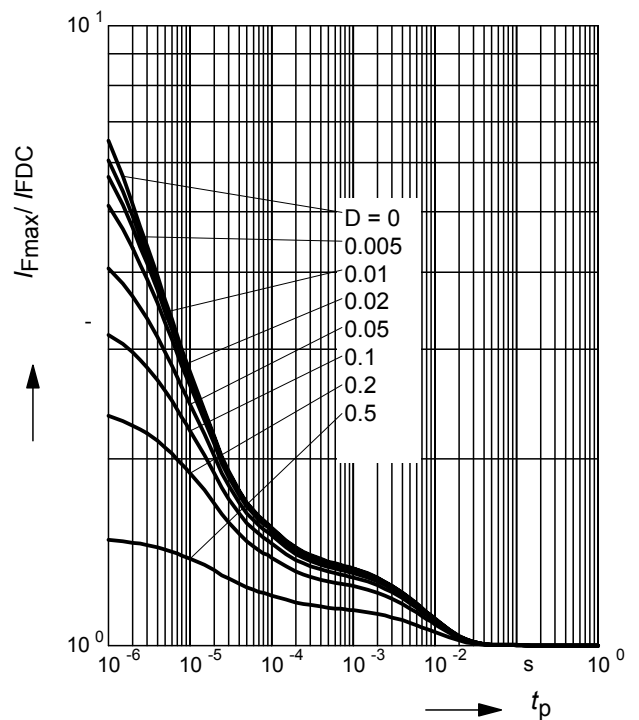

**Permissible Puls Load  $R_{thJS} = f(t_p)$**

BAR63-03W

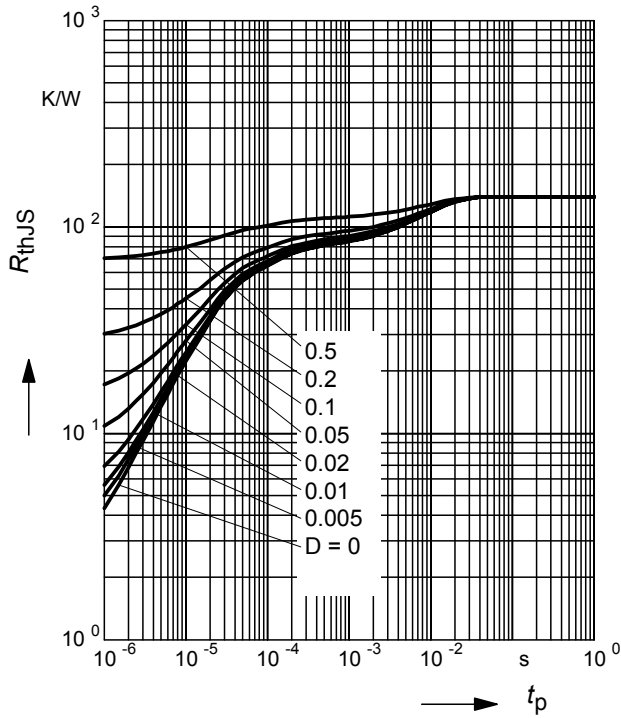

**Permissible Pulse Load**

$I_{Fmax} / I_{FDC} = f(t_p)$

BAR63-03W

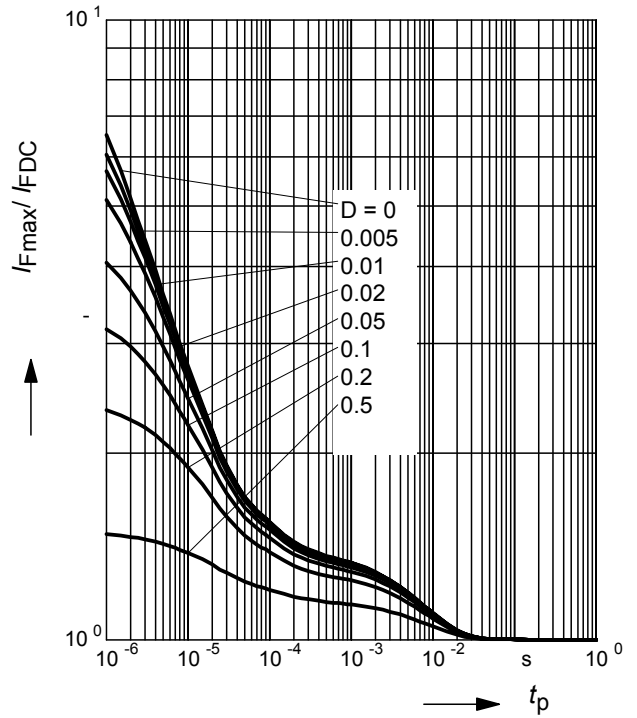

**Permissible Puls Load  $R_{thJS} = f(t_p)$**

BAR63-04W...BAR63-06W

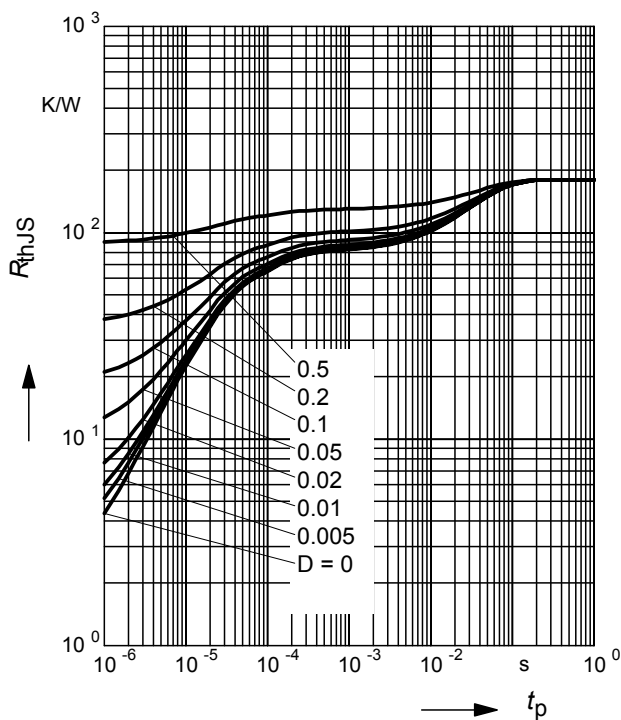

**Permissible Pulse Load**

$I_{Fmax} / I_{FDC} = f(t_p)$

BAR63-04W...BAR63-06W

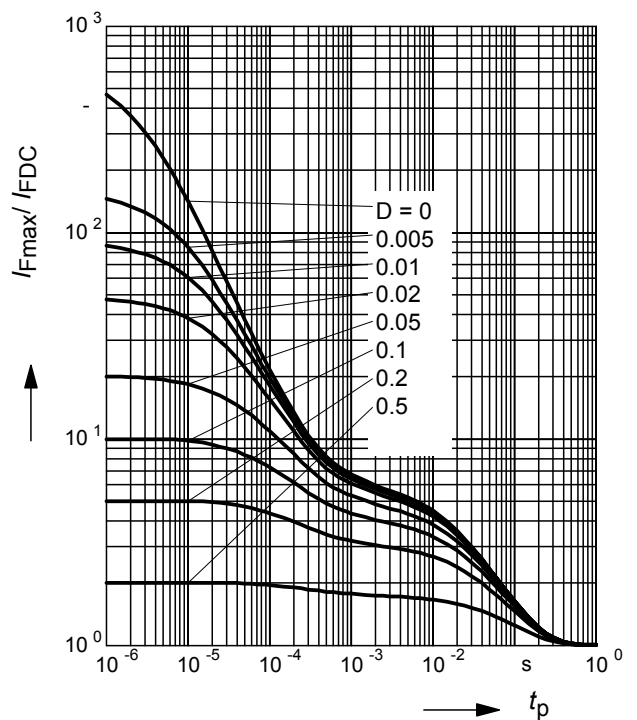

**Insertion loss**  $I_L = -|S_{21}|^2 = f(f)$

$I_F =$  Parameter

BAR63-02L in series configuration,  $Z = 50\Omega$

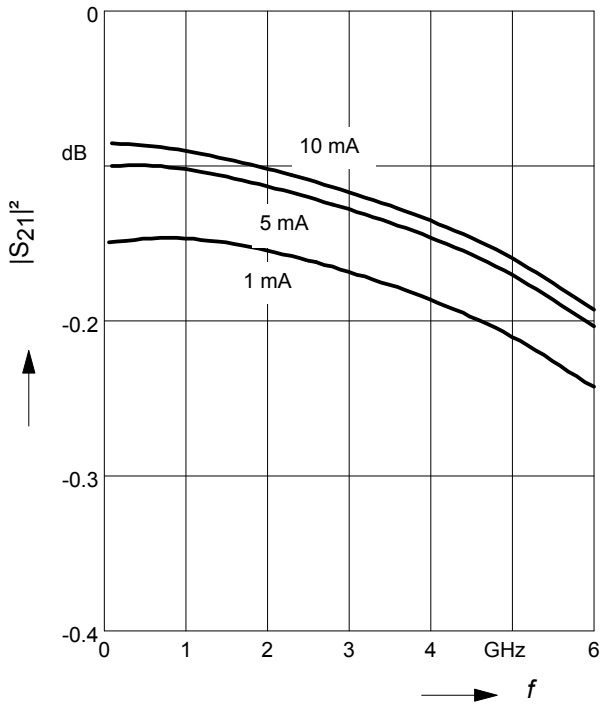

**Isolation**  $I_{SO} = -|S_{21}|^2 = f(f)$

$V_R =$  Parameter

BAR63-02L in series configuration,  $Z = 50\Omega$

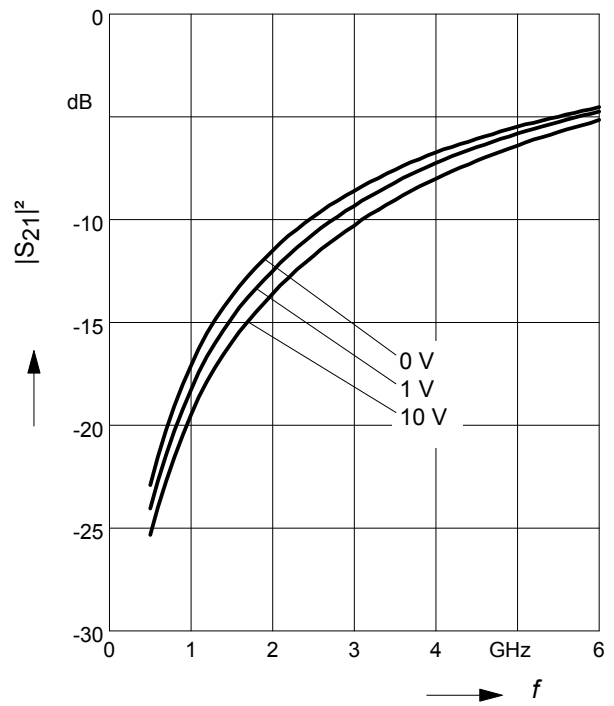

### Package Outline



### Foot Print

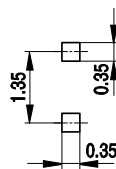

### Marking Layout (Example)

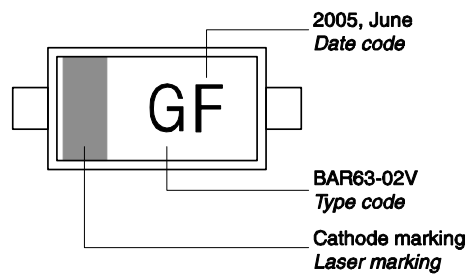

### Standard Packing

- Reel  $\varnothing$ 180 mm = 3.000 Pieces/Reel
- Reel  $\varnothing$ 180 mm = 8.000 Pieces/Reel (2 mm Pitch)
- Reel  $\varnothing$ 330 mm = 10.000 Pieces/Reel

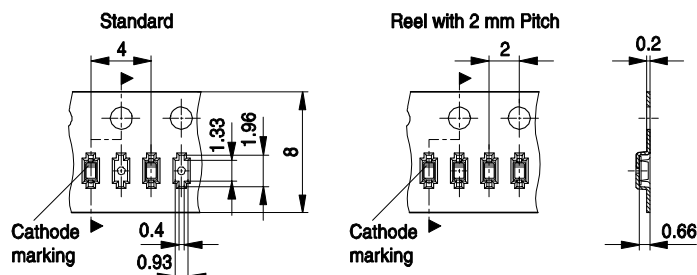

Package Outline

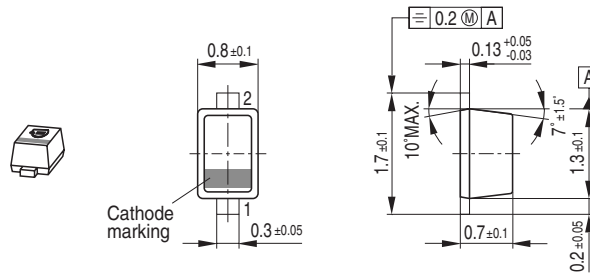

Foot Print

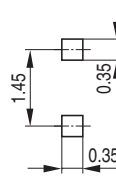

Marking Layout (Example)

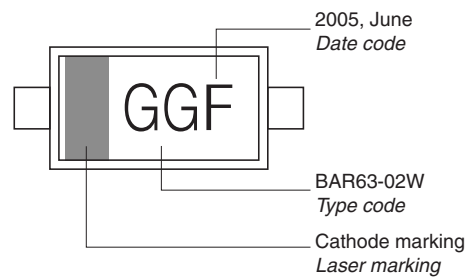

Standard Packing

Reel  $\varnothing$ 180 mm = 3.000 Pieces/Reel  
 Reel  $\varnothing$ 180 mm = 8.000 Pieces/Reel (2 mm Pitch)  
 Reel  $\varnothing$ 330 mm = 10.000 Pieces/Reel

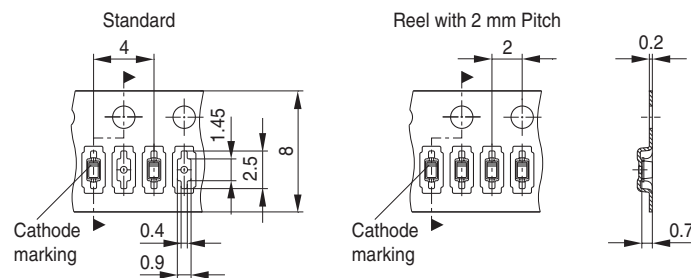

Date Code marking for discrete packages with one digit (SCD80, SC79, SC75<sup>1)</sup>) CES-Code

| Month | 2003 | 2004 | 2005 | 2006 | 2007 | 2008 | 2009 | 2010 | 2011 | 2012 | 2013 | 2014 |
|-------|------|------|------|------|------|------|------|------|------|------|------|------|
| 01    | a    | p    | A    | P    | a    | p    | A    | P    | a    | p    | A    | P    |
| 02    | b    | q    | B    | Q    | b    | q    | B    | Q    | b    | q    | B    | Q    |
| 03    | c    | r    | C    | R    | c    | r    | C    | R    | c    | r    | C    | R    |
| 04    | d    | s    | D    | S    | d    | s    | D    | S    | d    | s    | D    | S    |
| 05    | e    | t    | E    | T    | e    | t    | E    | T    | e    | t    | E    | T    |
| 06    | f    | u    | F    | U    | f    | u    | F    | U    | f    | u    | F    | U    |
| 07    | g    | v    | G    | V    | g    | v    | G    | V    | g    | v    | G    | V    |
| 08    | h    | x    | H    | X    | h    | x    | H    | X    | h    | x    | H    | X    |
| 09    | j    | y    | J    | Y    | j    | y    | J    | Y    | j    | y    | J    | Y    |
| 10    | k    | z    | K    | Z    | k    | z    | K    | Z    | k    | z    | K    | Z    |
| 11    | l    | 2    | L    | 4    | l    | 2    | L    | 4    | l    | 2    | L    | 4    |
| 12    | n    | 3    | N    | 5    | n    | 3    | N    | 5    | n    | 3    | N    | 5    |

1) New Marking Layout for SC75, implemented at October 2005.

Package Outline

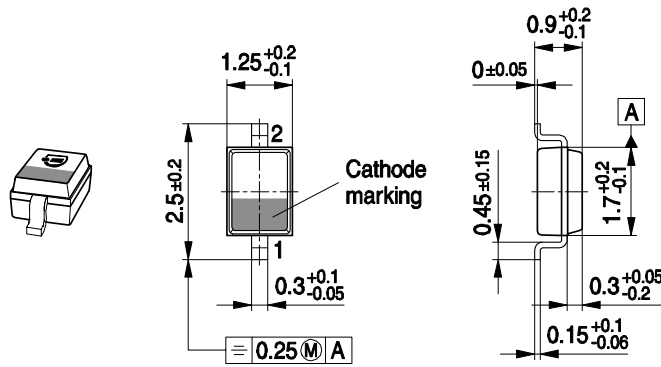

Foot Print

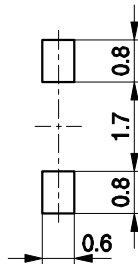

Marking Layout (Example)

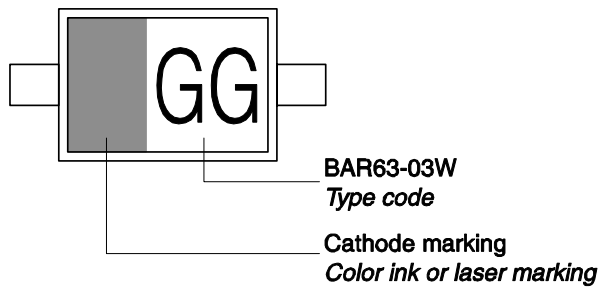

Standard Packing

Reel ø180 mm = 3.000 Pieces/Reel  
 Reel ø330 mm = 10.000 Pieces/Reel

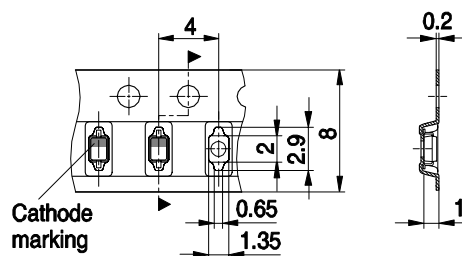

Package Outline

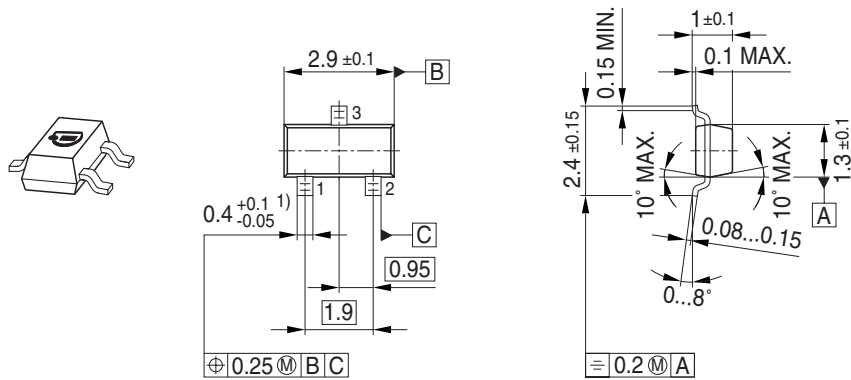

1) Lead width can be 0.6 max. in dambar area

Foot Print

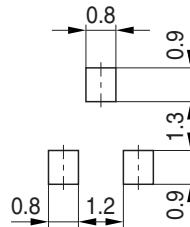

Marking Layout (Example)

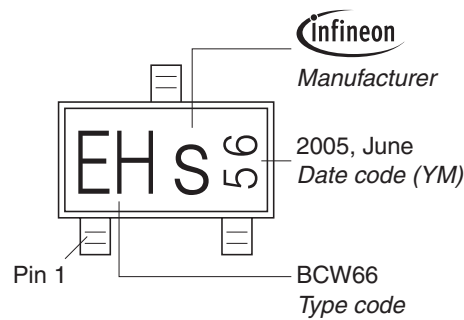

Standard Packing

Reel  $\varnothing$ 180 mm = 3.000 Pieces/Reel  
 Reel  $\varnothing$ 330 mm = 10.000 Pieces/Reel

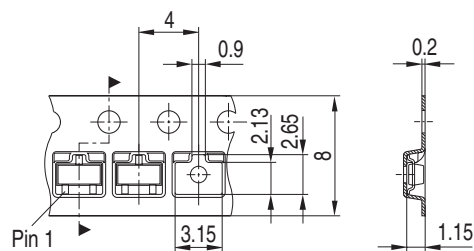

Package Outline

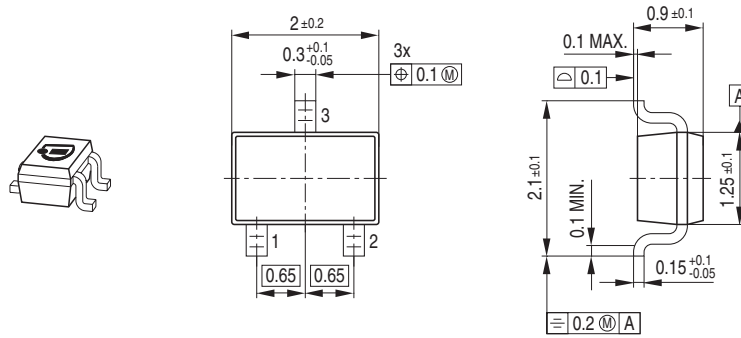

Foot Print

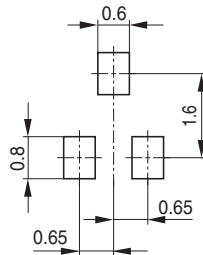

Marking Layout (Example)

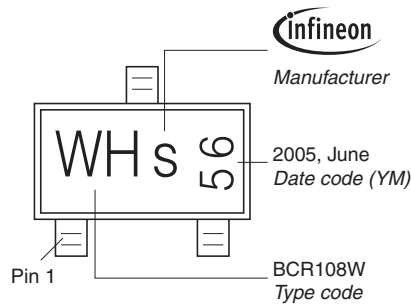

Standard Packing

Reel ø180 mm = 3.000 Pieces/Reel  
 Reel ø330 mm = 10.000 Pieces/Reel

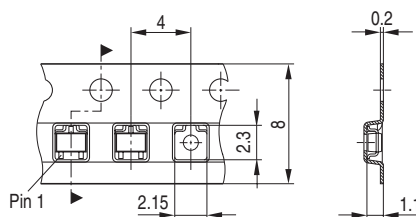

### Package Outline

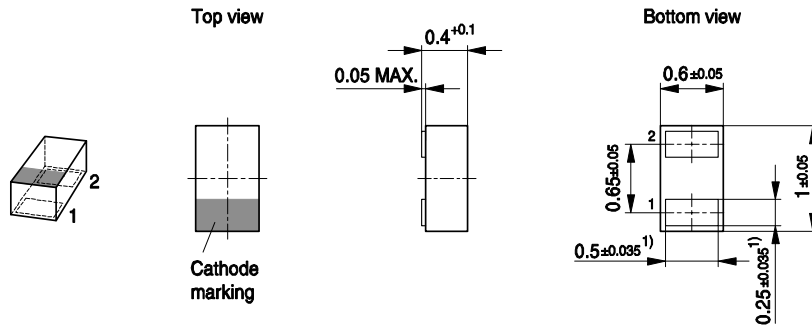

1) Dimension applies to plated terminal

### Foot Print

For board assembly information please refer to Infineon website "Packages"

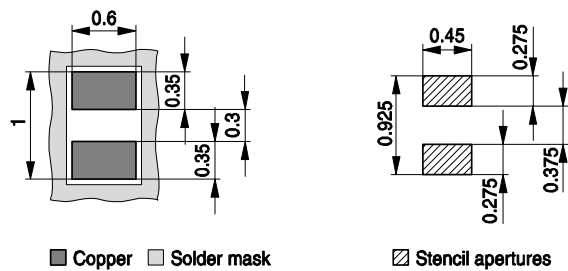

### Marking Layout (Example)

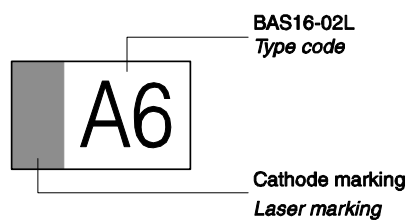

### Standard Packing

Reel  $\varnothing$ 180 mm = 15.000 Pieces/Reel  
 Reel  $\varnothing$ 330 mm = 50.000 Pieces/Reel (optional)

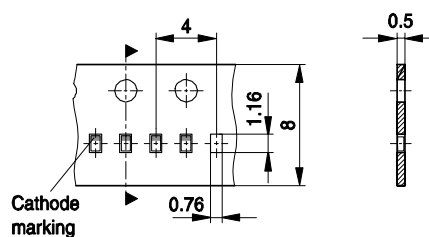

**Edition 2009-11-16**

**Published by  
Infineon Technologies AG  
81726 Munich, Germany**

**© 2009 Infineon Technologies AG  
All Rights Reserved.**

### **Legal Disclaimer**

The information given in this document shall in no event be regarded as a guarantee of conditions or characteristics. With respect to any examples or hints given herein, any typical values stated herein and/or any information regarding the application of the device, Infineon Technologies hereby disclaims any and all warranties and liabilities of any kind, including without limitation, warranties of non-infringement of intellectual property rights of any third party.

### **Information**

For further information on technology, delivery terms and conditions and prices, please contact the nearest Infineon Technologies Office ([<www.infineon.com>](http://www.infineon.com)).

### **Warnings**

Due to technical requirements, components may contain dangerous substances. For information on the types in question, please contact the nearest Infineon Technologies Office.

Infineon Technologies components may be used in life-support devices or systems only with the express written approval of Infineon Technologies, if a failure of such components can reasonably be expected to cause the failure of that life-support device or system or to affect the safety or effectiveness of that device or system. Life support devices or systems are intended to be implanted in the human body or to support and/or maintain and sustain and/or protect human life. If they fail, it is reasonable to assume that the health of the user or other persons may be endangered.

## Looking for pricing, stock, or lifecycle information?

Click below to explore more details on WIN SOURCE:

- ⊖ [View BAR 63-02V E6327 on WIN SOURCE](#)
- ⊖ [Infineon Technologies Information](#)

## Optimize Your Supply Chain with WIN SOURCE Solutions

- ✓ Global Sourcing Solution
- ✓ Obsolete Management
- ✓ Cost Control Management
- ✓ Shortage Management
- ✓ Alternative Solution
- ✓ Excess Inventory Management