

Ground Sense Comparator

BA8391G BA10393F BA10339 Series BA2903 Series BA2901 Series

General Description

General purpose BA8391G/BA10393F/BA10339xx and high reliability BA2903xxxx/BA2901xxx integrate one, two or four independent high gain voltage comparator.
Operating supply voltage range of BA8391G/BA10393F/BA2903xxxx/BA2901xxx is wide(2V to 36V).
And can be used in a variety of applications because current consumption is small. BA2903Wxx is a low input offset voltage products.(2mV max)

Features

- Operable with a Single Power Supply
- Wide Operating Supply Voltage
- Standard Pin Assignments
- Input and Output are Ground Sense Operated
- Open Collector
- Wide Temperature Range

Application

- General Use
- Current Monitor
- Battery Monitor
- Multi vibrator

Key Specifications

- Operating Supply Voltage(Single Supply):

BA8391G/BA10393F	+2.0V to +36.0V
BA2903xxxx/BA2901xxx	+2.0V to +36.0V
BA10339xx	+3.0V to +36.0V
- Operating Supply Voltage(Split Supply):

BA8391G/BA10393F	±1.0V to ±18.0V
BA2903xxxx/BA2901xxx	±1.0V to ±18.0V
BA10339xx	±1.5V to ±18.0V
- Temperature Range:

BA8391G/BA10393F/BA10339xx	-40°C to +85°C
BA2903Sxxx/BA2901Sxx	-40°C to +105°C
BA2903Wxx/BA2901xx	-40°C to +125°C
- Input Offset Voltage:

BA2903Sxxx/BA2901Sxx	7mV(Max)
BA8391G/BA2903xxxx/BA2901xx	7mV(Max)
BA10393F/BA10339xx	5mV(Max)
BA2903Wxx	2mV(Max)

Packages

	W(Typ) x D(Typ) x H(Max)
SSOP5	2.90mm x 2.80mm x 1.25mm
SOP8	5.00mm x 6.20mm x 1.71mm
SSOP-B8	3.00mm x 6.40mm x 1.35mm
MSOP8	2.90mm x 4.00mm x 0.90mm
SOP14	8.70mm x 6.20mm x 1.71mm
SSOP-B14	5.00mm x 6.40mm x 1.35mm

Selection Guide

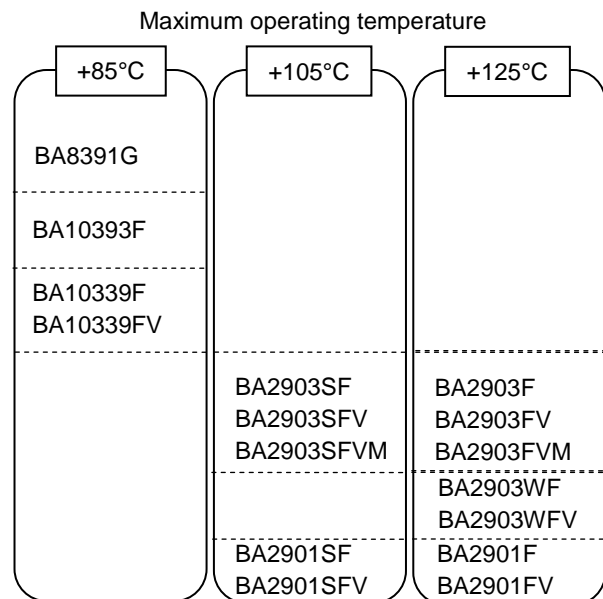
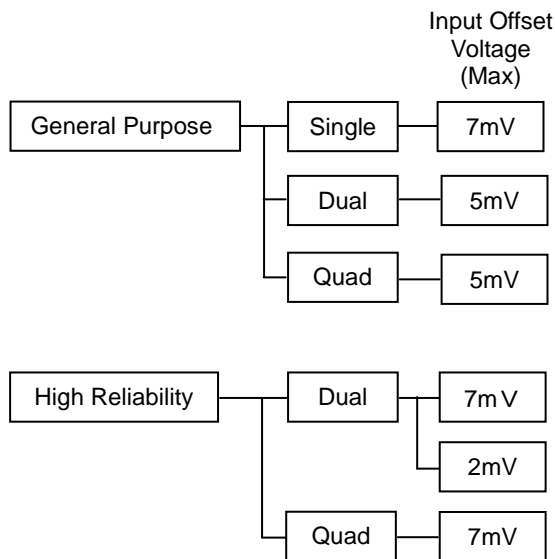

○Product structure : Silicon monolithic integrated circuit ○This product has no designed protection against radioactive rays

Simplified Schematic

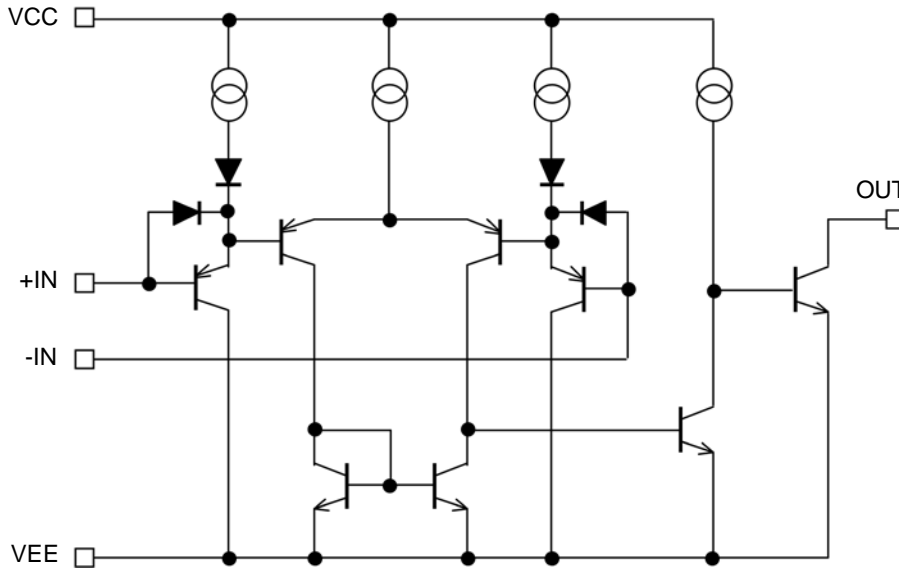
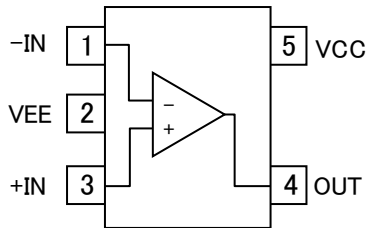

Figure 1. Simplified Schematic (one channel only)

Pin Configuration

BA8391G : SSOP5



Pin No.	Pin Name
1	-IN
2	VEE
3	+IN
4	OUT
5	VCC

BA10393F, BA2903SF, BA2903F, BA2903WF : SOP8
 BA2903SFV, BA2903FV, BA2903WFV : SSOP-B8
 BA2903SFVM, BA2903FVM : MSOP8

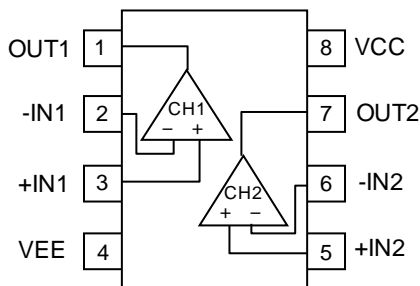

Pin No.	Pin Name
1	OUT1
2	-IN1
3	+IN1
4	VEE
5	+IN2
6	-IN2
7	OUT2
8	VCC

Pin Configuration - continued

BA10339F, BA2901SF, BA2901F : SOP14
 BA10339FV, BA2901SFV, BA2901FV : SSOP-B14

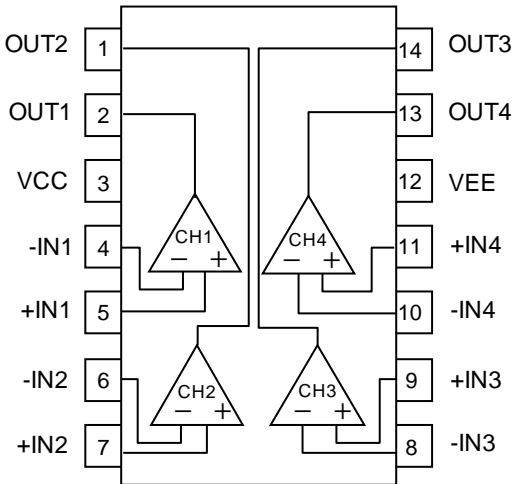

Pin No.	Pin Name
1	OUT2
2	OUT1
3	VCC
4	-IN1
5	+IN1
6	-IN2
7	+IN2
8	-IN3
9	+IN3
10	-IN4
11	+IN4
12	VEE
13	OUT4
14	OUT3

Package					
SSOP5	SOP8	SSOP-B8	MSOP8	SOP14	SSOP-B14
BA8391G	BA10393F BA2903SF BA2903F BA2903WF	BA2903SFV BA2903FV BA2903WFV	BA2903SFVM BA2903FVM	BA10339F BA2901SF BA2901F	BA10339FV BA2901SFV BA2901FV

Ordering Information

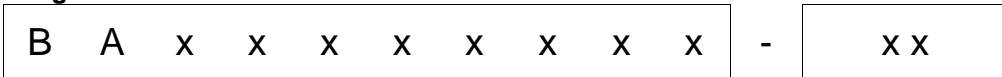

Part Number
 BA8391
 BA10393xx
 BA10339xx
 BA2901xx
 BA2901Sxx
 BA2903xx
 BA2903Sxx
 BA2903Wxx

Package
 G : SSOP5
 F : SOP8
 SOP14
 FV : SSOP-B8
 SSOP-B14
 FVM: MSOP8

Packaging and forming specification
 E2: Embossed tape and reel
 (SOP8/SOP14/SSOP-B8/SSOP-B14)
 TR: Embossed tape and reel
 (SSOP5/MSOP8)

Line-up

Operating Temperature Range	Input Offset Voltage (Max)	Supply Current (Typ)	Package		Orderable Part Number
-40°C to +85°C	7mV	0.3mA	SSOP5	Reel of 3000	BA8391G-TR
			SOP8	Reel of 2500	BA10393F-E2
	5mV	0.4mA	SOP14	Reel of 2500	BA10339F-E2
			SSOP-B14	Reel of 2500	BA10339FV-E2
-40°C to +105°C	7mV	0.6mA	SOP8	Reel of 2500	BA2903SF-E2
			SSOP-B8	Reel of 2500	BA2903SFV-E2
			MSOP8	Reel of 3000	BA2903SFVM-TR
		0.8mA	SOP14	Reel of 2500	BA2901SF-E2
			SSOP-B14	Reel of 2500	BA2901SFV-E2
-40°C to +125°C	7mV	0.6mA	SOP8	Reel of 2500	BA2903F-E2
			SSOP-B8	Reel of 2500	BA2903FV-E2
			MSOP8	Reel of 3000	BA2903FVM-TR
		0.8mA	SOP8	Reel of 2500	BA2903WF-E2
			SSOP-B8	Reel of 2500	BA2903WFV-E2
	2mV	0.8mA	SOP14	Reel of 2500	BA2901F-E2
			SSOP-B14	Reel of 2500	BA2901FV-E2

Absolute Maximum Ratings (Ta=25°C)

Parameter	Symbol	Rating		Unit
		BA8391G		
Supply Voltage	VCC-VEE	+36		V
Power Dissipation	P _D	SSOP5	0.67 ^(Note1,2)	W
Differential Input Voltage ^(Note 3)	V _{ID}	+36		V
Input Common-mode Voltage Range	V _{ICM}	(VEE-0.3) to (VEE+36)		V
Input Current ^(Note 4)	I _I	-10		mA
Operating Supply Voltage	V _{opr}	+2.0 to +36.0 (±1.0 to ±18.0)		V
Operating Temperature Range	T _{opr}	-40 to +85		°C
Storage Temperature Range	T _{stg}	-55 to +150		°C
Maximum Junction Temperature	T _{jmax}	+150		°C

(Note 1) To use at temperature above T_A=25°C reduce 5.4mW.

(Note 2) Mounted on a FR4 glass epoxy PCB(70mm×70mm×1.6mm).

(Note 3) The voltage difference between inverting input and non-inverting input is the differential input voltage.

Then input terminal voltage is set to more than VEE.

(Note 4) Excessive input current will flow if a differential input voltage in excess of approximately 0.6V is applied between the input unless some limiting resistance is used.

Caution: Operating the IC over the absolute maximum ratings may damage the IC. The damage can either be a short circuit between pins or an open circuit between pins and the internal circuitry. Therefore, it is important to consider circuit protection measures, such as adding a fuse, in case the IC is operated over the absolute maximum ratings.

Absolute Maximum Ratings - continued

Parameter	Symbol	Rating		Unit
		BA10393F	BA10339xx	
Supply Voltage	VCC-VEE	+36		V
Power Dissipation	P _D	SOP8	0.62 (Note 5,8)	-
		SOP14	-	0.49 (Note 6,8)
		SSOP-B14	-	0.70 (Note 7,8)
Differential Input Voltage (Note 9)	V _{ID}	(VEE to VCC)		V
Input Common-mode Voltage Range	V _{ICM}	(VEE-0.3) to VCC		V
Input Current (Note 10)	I _I	-10		mA
Operating Supply Voltage	V _{opr}	+2.0 to +36.0 (±1.0 to ±18.0)	+3.0 to +36.0 (±1.5 to ±18.0)	V
Operating Temperature Range	T _{opr}	-40 to +85		°C
Storage Temperature Range	T _{stg}	-55 to +125		°C
Maximum Junction Temperature	T _{jmax}	+125		°C

(Note 5) To use at temperature above T_A=25°C reduce 6.2mW.

(Note 6) To use at temperature above T_A=25°C reduce 4.9mW.

(Note 7) To use at temperature above T_A=25°C reduce 7.0mW.

(Note 8) Mounted on a FR4 glass epoxy PCB(70mm×70mm×1.6mm).

(Note 9) The voltage difference between inverting input and non-inverting input is the differential input voltage.

Then input terminal voltage is set to more than VEE.

(Note 10) Excessive input current will flow if a differential input voltage in excess of approximately 0.6V is applied between the input unless some limiting resistance is used.

Caution: Operating the IC over the absolute maximum ratings may damage the IC. The damage can either be a short circuit between pins or an open circuit between pins and the internal circuitry. Therefore, it is important to consider circuit protection measures, such as adding a fuse, in case the IC is operated over the absolute maximum ratings.

Parameter	Symbol	Rating				Unit
		BA2903Sxxx	BA2901Sxx	BA2903xxx	BA2901xx	
Supply Voltage	VCC-VEE	+36				V
Power Dissipation	P _D	SOP8	0.77 (Note 11,16)	-	0.77 (Note 11,16)	-
		SSOP-B8	0.68 (Note 12,16)	-	0.68 (Note 12,16)	-
		MSOP8	0.58 (Note 13,16)	-	0.58 (Note 13,16)	-
		SOP14	-	0.61 (Note 14,16)	-	0.61 (Note 14,16)
		SSOP-B14	-	0.87 (Note 15,16)	-	0.87 (Note 15,16)
Differential Input Voltage (Note 17)	V _{ID}	36				V
Input Common-mode Voltage Range	V _{ICM}	(VEE-0.3) to (VEE+36)				V
Input Current (Note 18)	I _I	-10				mA
Operating Supply Voltage	V _{opr}	+2.0 to +36.0 (±1.0 to ±18.0)				V
Operating Temperature Range	T _{opr}	-40 to +105		-40 to +125		°C
Storage Temperature Range	T _{stg}	-55 to +150				°C
Maximum Junction Temperature	T _{jmax}	+150				°C

(Note 11) To use at temperature above T_A=25°C reduce 6.2mW.

(Note 12) To use at temperature above T_A=25°C reduce 5.5mW.

(Note 13) To use at temperature above T_A=25°C reduce 4.7mW.

(Note 14) To use at temperature above T_A=25°C reduce 4.9mW.

(Note 15) To use at temperature above T_A=25°C reduce 7.0mW.

(Note 16) Mounted on a FR4 glass epoxy PCB(70mm×70mm×1.6mm).

(Note 17) The voltage difference between inverting input and non-inverting input is the differential input voltage.

Then input terminal voltage is set to more than VEE.

(Note 18) Excessive input current will flow if a differential input voltage in excess of approximately 0.6V is applied between the input unless some limiting resistance is used.

Caution: Operating the IC over the absolute maximum ratings may damage the IC. The damage can either be a short circuit between pins or an open circuit between pins and the internal circuitry. Therefore, it is important to consider circuit protection measures, such as adding a fuse, in case the IC is operated over the absolute maximum ratings.

Electrical Characteristics

OBA8391G(Unless otherwise specified VCC=+5V, VEE=0V, T_A=25°C)

Parameter	Symbol	Temperature Range	Limit			Unit	Conditions
			Min	Typ	Max		
Input Offset Voltage (Note 19,20)	V _{IO}	25°C	-	2	7	mV	OUT=1.4V
		Full range	-	-	15		VCC=5 to 36V, OUT=1.4V
Input Offset Current (Note 19,20)	I _{IO}	25°C	-	5	50	nA	OUT=1.4V
		Full range	-	-	200		
Input Bias Current (Note 20,21)	I _B	25°C	-	50	250	nA	OUT=1.4V
		Full range	-	-	500		
Input Common-mode Voltage Range	V _{ICM}	25°C	0	-	VCC -1.5	V	-
Large Signal Voltage Gain	A _V	25°C	25	100	-	V/mV	VCC=15V, OUT=1.4 to 11.4V R _L =15kΩ, V _{RL} =15V
			88	100	-		
Supply Current (Note 20)	I _{CC}	25°C	-	0.3	0.7	mA	OUT=Open
		Full range	-	-	1.3		OUT=Open, VCC=36V
Output Sink Current (Note 22)	I _{SINK}	25°C	6	16	-	mA	+IN=0V, -IN=1V OUT=1.5V
Output Saturation Voltage (Low Level Output Voltage) (Note 20)	V _{OL}	25°C	-	150	400	mV	+IN= 0V, -IN=1V I _{SINK} =4mA
		Full range	-	-	700		
Output Leakage Current (Note 20) (High Level Output Current)	I _{LEAK}	25°C	-	0.1	-	nA	+IN=1V, -IN=0V OUT=5V
		Full range	-	-	1	μA	+IN=1V, -IN=0V OUT=36V
Response Time	t _{RE}	25°C	-	1.3	-	μs	R _L =5.1kΩ, V _{RL} =5V IN=100mV _{P-P} , Overdrive=5mV
			-	0.4	-		R _L =5.1kΩ, V _{RL} =5V, IN=TTL Logic Swing, V _{REF} =1.4V

(Note 19) Absolute value

(Note 20) Full range T_A=-40°C to +85°C

(Note 21) Current Direction: Because the first stage is composed with PNP transistor, input bias current flows out of IC.

(Note 22) Please determine the output current value in consideration of the power dissipation of the IC under high temperature environment.

When the output terminal is continuously shorted, output current may be reduced by the temperature rise of the IC.

Electrical Characteristics - continued

OBA10393F (Unless otherwise specified VCC=+5V, VEE=0V, T_A=25°C)

Parameter	Symbol	Temperature Range	Limit			Unit	Conditions
			Min	Typ	Max		
Input Offset Voltage ^(Note 23)	V _{IO}	25°C	-	1	5	mV	OUT=1.4V
Input Offset Current ^(Note 23)	I _{IO}	25°C	-	5	50	nA	OUT=1.4V
Input Bias Current ^(Note 24)	I _B	25°C	-	50	250	nA	OUT=1.4V
Input Common-mode Voltage Range	V _{ICM}	25°C	0	-	VCC -1.5	V	-
Large Signal Voltage Gain	A _V	25°C	50	200	-	V/mV	VCC=15V, OUT=1.4 ~ 11.4V R _L =15kΩ, V _{RL} =15V
			94	106	-	dB	
Supply Current	I _{CC}	25°C	-	0.4	1	mA	R _L =∞, All Comparators
Output Sink Current ^(Note 25)	I _{SINK}	25°C	6	16	-	mA	-IN=1V, +IN=0V OUT=1.5V
Output Saturation Voltage (Low Level Output Voltage)	V _{OL}	25°C	-	250	400	mV	-IN=1V, +IN=0V I _{SINK} =4mA
Output Leakage Current (High Level Output Current)	I _{LEAK}	25°C	-	0.1	-	nA	-IN=0V, +IN=1V OUT=5V
		25°C	-	-	1	μA	-IN=0V, +IN=1V OUT=36V
Response Time	t _{RE}	25°C	-	1.3	-	μs	R _L =5.1kΩ, V _{RL} =5V IN=100mV _{P-P} , Overdrive=5mV R _L =5.1kΩ, V _{RL} =5V, IN=TTL Logic Swing, V _{REF} =1.4V
			-	0.4	-		

(Note 23) Absolute value

(Note 24) Current Direction: Because the first stage is composed with PNP transistor, input bias current flows out of IC.

(Note 25) Please determine the output current value in consideration of the power dissipation of the IC under high temperature environment.
When the output terminal is continuously shorted, output current may be reduced by the temperature rise of the IC.OBA10339 xx(Unless otherwise specified VCC=+5V, VEE=0V, T_A=25°C)

Parameter	Symbol	Temperature Range	Limit			Unit	Conditions
			Min	Typ	Max		
Input Offset Voltage ^(Note 26)	V _{IO}	25°C	-	1	5	mV	OUT=1.4V
Input Offset Current ^(Note 26)	I _{IO}	25°C	-	5	50	nA	OUT=1.4V
Input Bias Current ^(Note 27)	I _B	25°C	-	50	250	nA	OUT=1.4V
Input Common-mode Voltage Range	V _{ICM}	25°C	0	-	VCC -1.5	V	-
Large Signal Voltage Gain	A _V	25°C	50	200	-	V/mV	VCC=15V, OUT=1.4 ~ 11.4V R _L =15kΩ, V _{RL} =15V
			94	106	-	dB	
Supply Current	I _{CC}	25°C	-	0.8	2	mA	R _L =∞, All Comparators
Output Sink Current ^(Note 28)	I _{SINK}	25°C	6	16	-	mA	-IN=1V, +IN=0V OUT=1.5V
Output Saturation Voltage (Low Level Output Voltage)	V _{OL}	25°C	-	250	400	mV	-IN=1V, +IN=0V I _{SINK} =4mA
Output Leakage Current (High Level Output Current)	I _{LEAK}	25°C	-	0.1	-	nA	-IN=0V, +IN=1V OUT=5V
		25°C	-	-	1	μA	-IN=0V, +IN=1V OUT=36V
Response Time	t _{RE}	25°C	-	1.3	-	μs	R _L =5.1kΩ, V _{RL} =5V IN=100mV _{P-P} , Overdrive=5mV R _L =5.1kΩ, V _{RL} =5V, IN=TTL Logic Swing, V _{REF} =1.4V
			-	0.4	-		

(Note 26) Absolute value

(Note 27) Current Direction: Because the first stage is composed with PNP transistor, input bias current flows out of IC.

(Note 28) Please determine the output current value in consideration of the power dissipation of the IC under high temperature environment.
When the output terminal is continuously shorted, output current may be reduced by the temperature rise of the IC.

Electrical Characteristics - continued

OBA2903xxx, BA2903S xxx (Unless otherwise specified VCC=+5V, VEE=0V, T_A=25°C)

Parameter	Symbol	Temperature Range	Limit			Unit	Conditions
			Min	Typ	Max		
Input Offset Voltage ^(Note 29,30)	V _{IO}	25°C	-	2	7	mV	OUT=1.4V
		Full range	-	-	15		VCC=5 to 36V, OUT=1.4V
Input Offset Current ^(Note 29,30)	I _{IO}	25°C	-	5	50	nA	OUT=1.4V
		Full range	-	-	200		
Input Bias Current ^(Note 30,31)	I _B	25°C	-	50	250	nA	OUT=1.4V
		Full range	-	-	500		
Input Common-mode Voltage Range	V _{ICM}	25°C	0	-	VCC -1.5	V	-
Large Signal Voltage Gain	A _v	25°C	25	100	-	V/mV	VCC=15V, OUT=1.4 to 11.4V R _L =15kΩ, V _{RL} =15V
			88	100	-	dB	
Supply Current ^(Note 30)	I _{CC}	25°C	-	0.6	1	mA	OUT=Open
		Full range	-	-	2.5		OUT=Open, VCC=36V
Output Sink Current ^(Note 32)	I _{SINK}	25°C	6	16	-	mA	+IN=0V, -IN=1V OUT=1.5V
Output Saturation Voltage ^(Note 30) (Low Level Output Voltage)	V _{OL}	25°C	-	150	400	mV	+IN=0V, -IN= 1V I _{SINK} =4mA
		Full range	-	-	700		
Output Leakage Current ^(Note 30) (High Level Output Current)	I _{LEAK}	25°C	-	0.1	-	nA	+IN=1V, -IN=0V OUT=5V
		Full range	-	-	1	μA	+IN=1V, -IN=0V OUT=36V
Response Time	t _{RE}	25°C	-	1.3	-	μs	R _L =5.1kΩ, V _{RL} =5V IN=100mV _{P-P} , Overdrive=5mV
			-	0.4	-		R _L =5.1kΩ, V _{RL} =5V, IN=TTL Logic Swing, V _{REF} =1.4V

(Note 29) Absolute value

(Note 30) BA2903S : Full range -40°C to +105°C, BA2903: Full range -40°C to +125°C

(Note 31) Current Direction: Because the first stage is composed with PNP transistor, input bias current flows out of IC.

(Note 32) Please determine the output current value in consideration of the power dissipation of the IC under high temperature environment.

When the output terminal is continuously shorted, output current may be reduced by the temperature rise of the IC.

Electrical Characteristics - continued

OBA2903Wxx (Unless otherwise specified VCC=+5V, VEE=0V, T_A=25°C)

Parameter	Symbol	Temperature Range	Limit			Unit	Conditions
			Min	Typ	Max		
Input Offset Voltage ^(Note 33)	V _{IO}	25°C	-	0.5	2	mV	OUT=1.4V
Input Offset Current ^(Note 33)	I _{IO}	25°C	-	5	50	nA	OUT=1.4V
Input Bias Current ^(Note 34,35)	I _B	25°C	-	50	250	nA	OUT=1.4V
		Full range	-	-	500		
Input Common-mode Voltage Range	V _{ICM}	25°C	0	-	VCC -1.5	V	-
Large Signal Voltage Gain	A _V	25°C	25	100	-	V/mV	VCC=15V, OUT=1.4 to 11.4V R _L =15kΩ, V _{RL} =15V
			88	100	-	dB	
Supply Current ^(Note 34)	I _{CC}	25°C	-	0.6	1	mA	OUT=Open
		Full range	-	-	2.5		OUT=Open, VCC=36V
Output Sink Current ^(Note 36)	I _{SINK}	25°C	6	16	-	mA	+IN=0V, -IN=1V OUT=1.5V
Output Saturation Voltage ^(Note 34) (Low Level Output Voltage)	V _{OL}	25°C	-	150	400	mV	+IN=0V, -IN= 1V I _{SINK} =4mA
		Full range	-	-	700		
Output Leakage Current ^(Note 34) (High Level Output Current)	I _{LEAK}	25°C	-	0.1	-	nA	+IN=1V, -IN=0V OUT=5V
		Full range	-	-	1	μA	+IN=1V, -IN=0V OUT=36V
Response Time	t _{RE}	25°C	-	1.3	-	μs	R _L =5.1kΩ, V _{RL} =5V IN=100mV _{P-P} , Overdrive=5mV
			-	0.4	-		R _L =5.1kΩ, V _{RL} =5V, IN=TTL Logic Swing, V _{REF} =1.4V

(Note 33) Absolute value

(Note 34) BA2903W: Full range -40°C to +125°C

(Note 35) Current Direction: Because the first stage is composed with PNP transistor, input bias current flows out of IC.

(Note 36) Please determine the output current value in consideration of the power dissipation of the IC under high temperature environment.

When the output terminal is continuously shorted, output current may be reduced by the temperature rise of the IC.

Electrical Characteristics - continued

OBA2901xx, BA2901S xx (Unless otherwise specified VCC=+5V, VEE=0V, Ta=25°C)

Parameter	Symbol	Temperature Range	Limit			Unit	Conditions
			Min	Typ	Max		
Input Offset Voltage (Note 37,38)	V _{IO}	25°C	-	2	7	mV	OUT=1.4V
		Full range	-	-	15		VCC=5 to 36V, OUT=1.4V
Input Offset Current (Note 37,38)	I _{IO}	25°C	-	5	50	nA	OUT=1.4V
		Full range	-	-	200		
Input Bias Current (Note 38,39)	I _B	25°C	-	50	250	nA	OUT=1.4V
		Full range	-	-	500		
Input Common-mode Voltage Range	V _{ICM}	25°C	0	-	VCC-1.5	V	-
Large Signal Voltage Gain	A _V	25°C	25	100	-	V/mV	VCC=15V, OUT=1.4 to 11.4V R _L =15kΩ, V _{RL} =15V
			88	100	-	dB	
Supply Current (Note 38)	I _{CC}	25°C	-	0.8	2	mA	OUT=Open
		Full range	-	-	2.5		OUT=Open, VCC=36V
Output Sink Current (Note 40)	I _{SINK}	25°C	6	16	-	mA	+IN=0V, V _{IN} =1V OUT=1.5V
Output Saturation Voltage (Low Level Output Voltage) (Note 38)	V _{OL}	25°C	-	150	400	mV	+IN=0V, -IN=1V I _{SINK} =4mA
		Full range	-	-	700		
Output Leakage Current (High Level Output Current) (Note 38)	I _{LEAK}	25°C	-	0.1	-	nA	+IN=1V, -IN=0V OUT=5V
		Full range	-	-	1	μA	+IN=1V, -IN=0V OUT=36V
Response Time	t _{RE}	25°C	-	1.3	-	μs	R _L =5.1kΩ, V _{RL} =5V V _{IN} =100mV _{P-P} , Overdrive=5mV
			-	0.4	-		R _L =5.1kΩ, V _{RL} =5V, V _{IN} =TTL Logic Swing, V _{REF} =1.4V

(Note 37) Absolute value

(Note 38) BA2901S : Full range -40°C to 105°C ,BA2901 : Full range -40°C to +125°C

(Note 39) Current Direction : Because the first stage is composed with PNP transistor, input bias current flows out of IC.

(Note 40) Please determine the output current value in consideration of the power dissipation of the IC under high temperature environment.

When the output terminal is continuously shorted, output current may be reduced by the temperature rise of the IC.

Description of electrical characteristics

Described below are descriptions of the relevant electrical terms used in this datasheet. Items and symbols used are also shown. Note that item name and symbol and their meaning may differ from those on another manufacturer's document or general document.

1. Absolute maximum ratings

Absolute maximum rating items indicate the condition which must not be exceeded. Application of voltage in excess of absolute maximum rating or use out of absolute maximum rated temperature environment may cause deterioration of characteristics.

- (1) Power supply voltage (V_{CC}/V_{EE})
Indicates the maximum voltage that can be applied between the positive power supply terminal and negative power supply terminal without deterioration or destruction of characteristics of internal circuit.
- (2) Differential input voltage (V_{ID})
Indicates the maximum voltage that can be applied between non-inverting and inverting terminals without damaging the IC.
- (3) Input common-mode voltage range (V_{ICM})
Indicates the maximum voltage that can be applied to the non-inverting and inverting terminals without deterioration or destruction of electrical characteristics. Input common-mode voltage range of the maximum ratings does not assure normal operation of IC. For normal operation, use the IC within the input common-mode voltage range characteristics.
- (4) Power dissipation (P_d)
Indicates the power that can be consumed by the IC when mounted on a specific board at the ambient temperature 25°C (normal temperature). As for package product, P_d is determined by the temperature that can be permitted by the IC in the package (maximum junction temperature) and the thermal resistance of the package.

2. Electrical characteristics

- (1) Input offset voltage (V_{IO})
Indicates the voltage difference between non-inverting terminal and inverting terminals. It can be translated into the input voltage difference required for setting the output voltage at 0 V.
- (2) Input offset current (I_{IO})
Indicates the difference of input bias current between the non-inverting and inverting terminals.
- (3) Input bias current (I_B)
Indicates the current that flows into or out of the input terminal. It is defined by the average of input bias currents at the non-inverting and inverting terminals.
- (4) Input common-mode voltage range (V_{ICM})
Indicates the input voltage range where IC normally operates.
- (5) Large signal voltage gain (A_V)
Indicates the amplifying rate (gain) of output voltage against the voltage difference between non-inverting terminal and inverting terminal. It is normally the amplifying rate (gain) with reference to DC voltage.
 $A_V = (\text{Output voltage}) / (\text{Differential Input voltage})$
- (6) Supply current (I_{CC})
Indicates the current that flows within the IC under specified no-load conditions.
- (7) Output sink current (I_{SINK})
Denotes the maximum current that can be output under specific output conditions.
- (8) Output saturation voltage, low level output voltage (V_{OL})
Signifies the voltage range that can be output under specific output conditions.
- (9) Output leakage current, High level output current (I_{LEAK})
Indicates the current that flows into the IC under specific input and output conditions.
- (10) Response time (t_{RE})
Response time indicates the delay time between the input and output signal is determined by the time difference from the fifty percent of input signal swing to the fifty percent of output signal swing.

Typical Performance Curves

OBA8391G

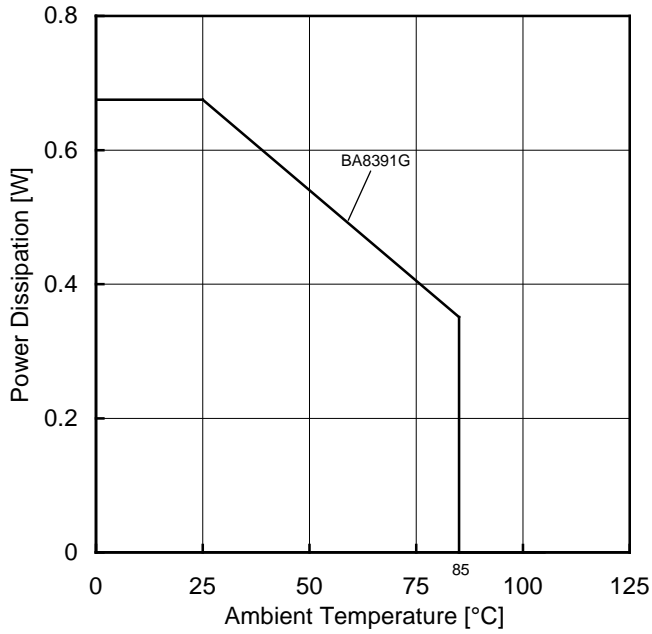

Figure 2.
Power Dissipation vs Ambient Temperature
(Derating Curve)

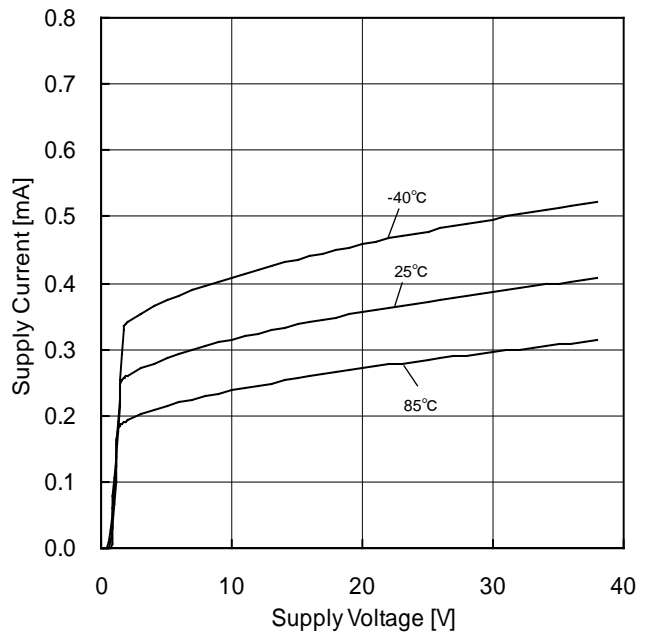

Figure 3.
Supply Current vs Supply Voltage

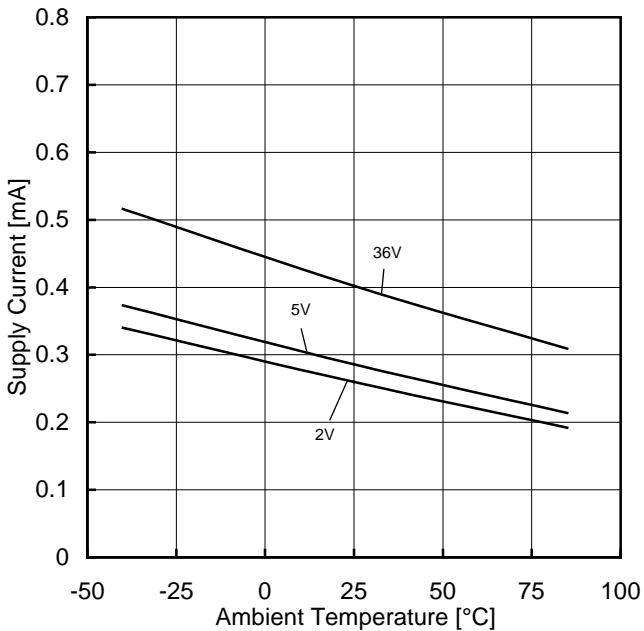

Figure 4.
Supply Current vs Ambient Temperature

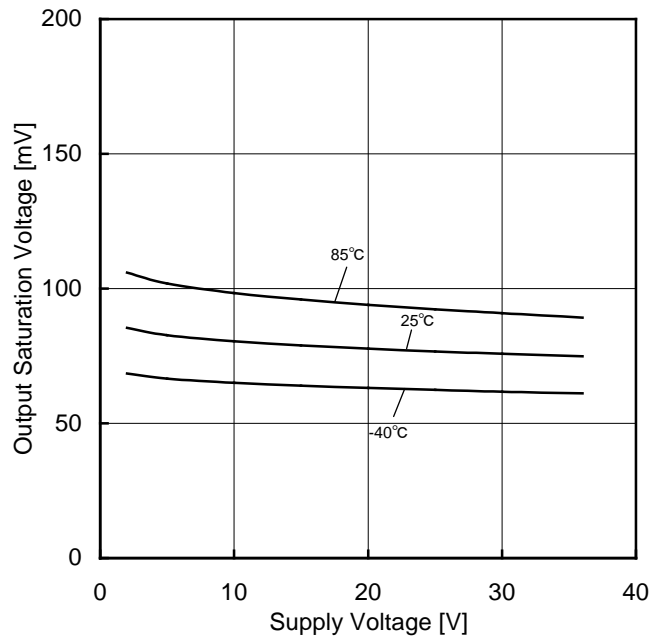

Figure 5.
Output Saturation Voltage vs Supply Voltage
($I_{OL}=4mA$)

(*)The above characteristics are measurements of typical sample, they are not guaranteed.

Typical Performance Curves - continued

OBA8391G

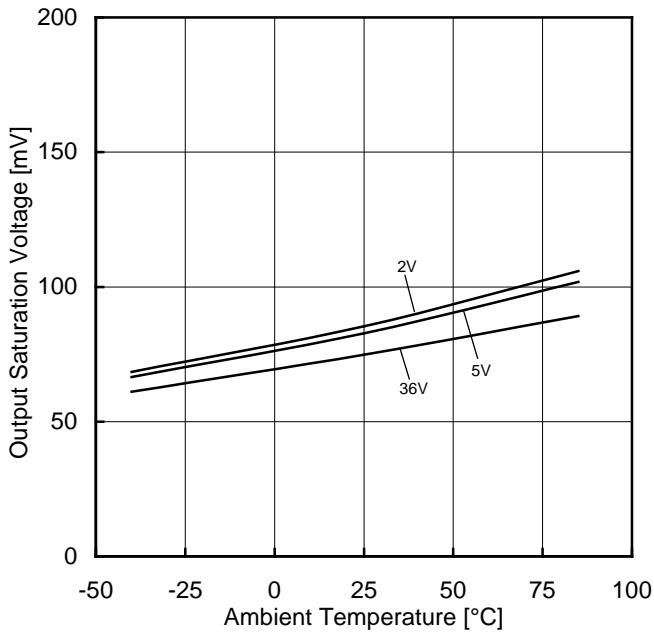

Figure 6.
Output Saturation Voltage vs Ambient Temperature
($I_{OL}=4mA$)

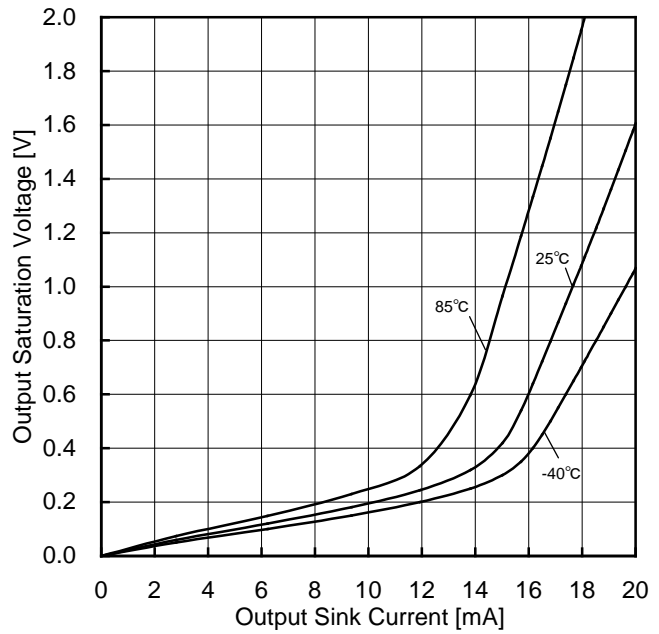

Figure 7.
Output Saturation Voltage vs
Output Sink Current
($V_{CC}=5V$)

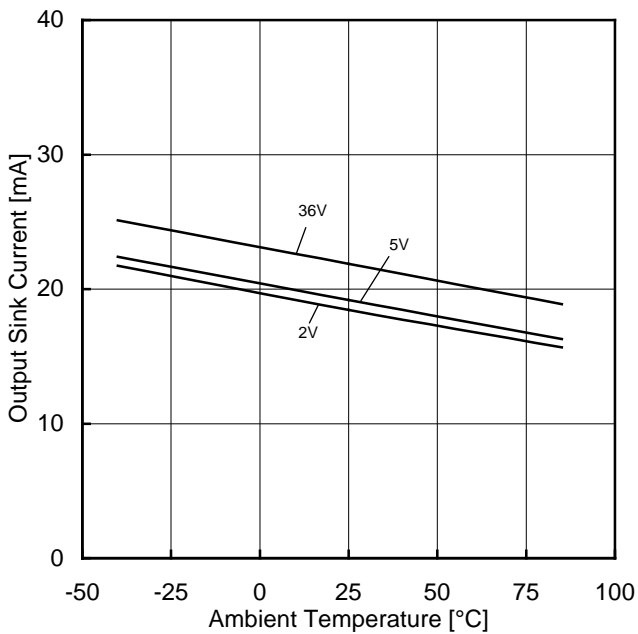

Figure 8.
Output Sink Current vs Ambient Temperature
($OUT=1.5V$)

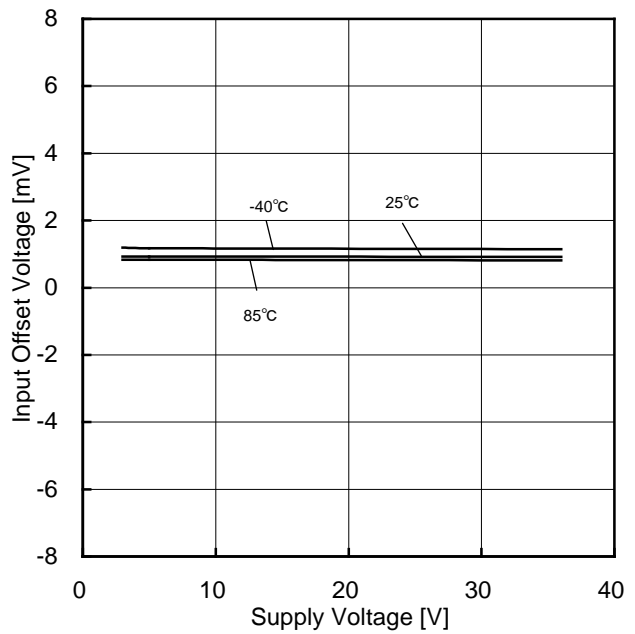

Figure 9.
Input Offset Voltage vs Supply Voltage

(*)The above characteristics are measurements of typical sample, they are not guaranteed.

Typical Performance Curves - continued

OBA8391G

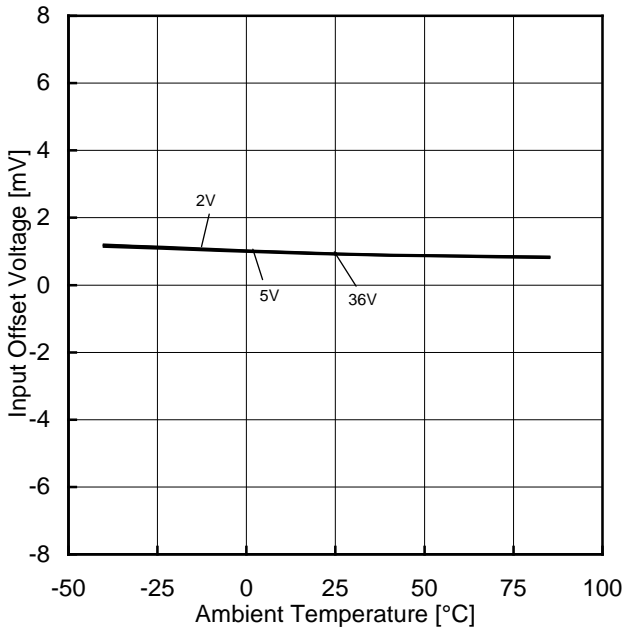

Figure 10.
Input Offset Voltage vs Ambient Temperature

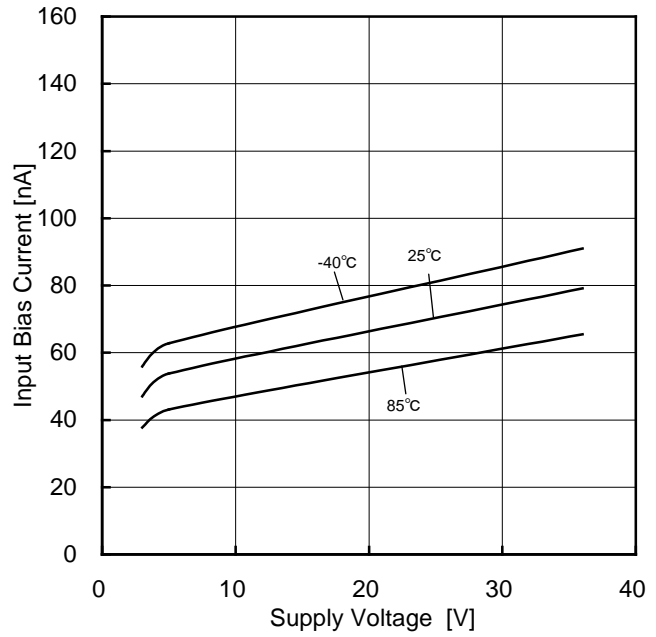

Figure 11.
Input Bias Current vs Supply Voltage

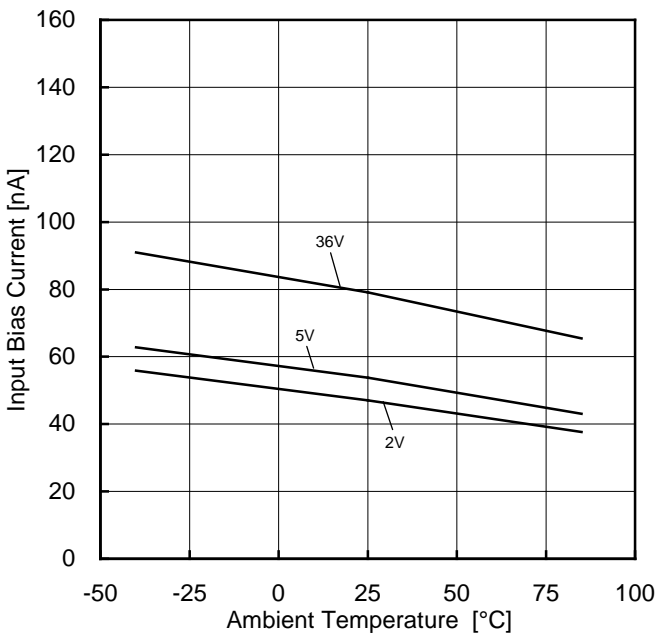

Figure 12.
Input Bias Current vs Ambient Temperature

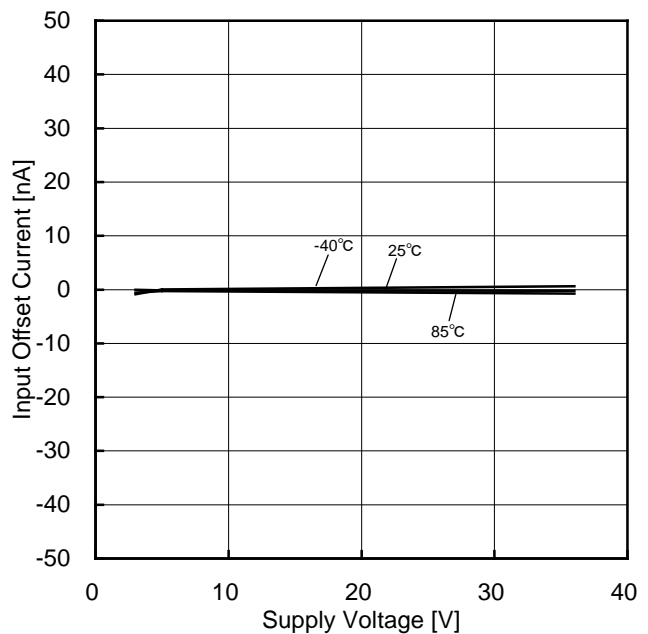

Figure 13.
Input Offset Current vs Supply Voltage

(*)The above characteristics are measurements of typical sample, they are not guaranteed.

Typical Performance Curves - continued

OBA8391G

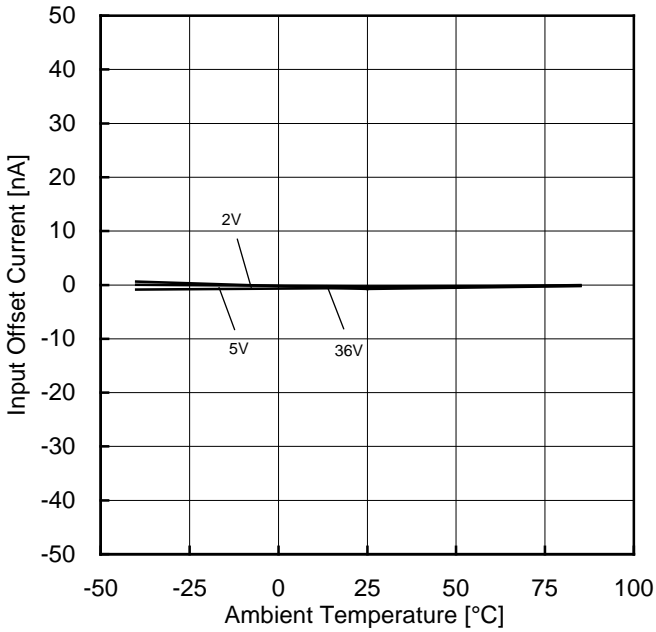

Figure 14.
Input Offset Current vs Ambient Temperature

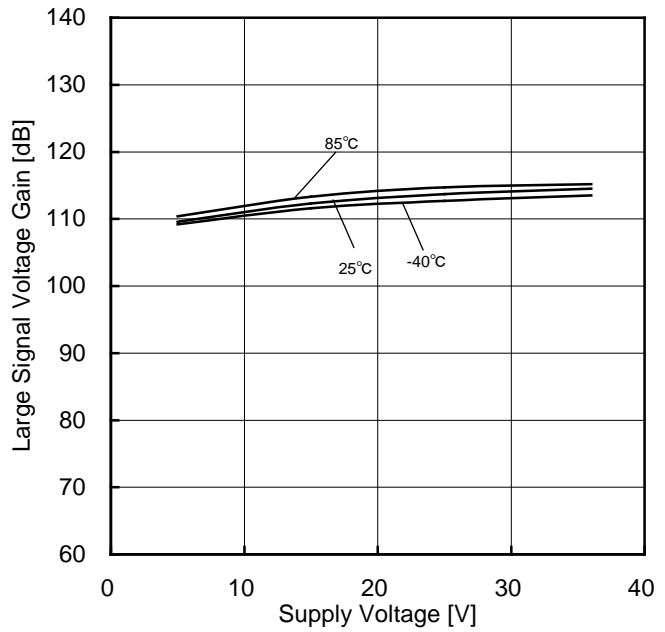

Figure 15.
Large Signal Voltage Gain vs Supply Voltage

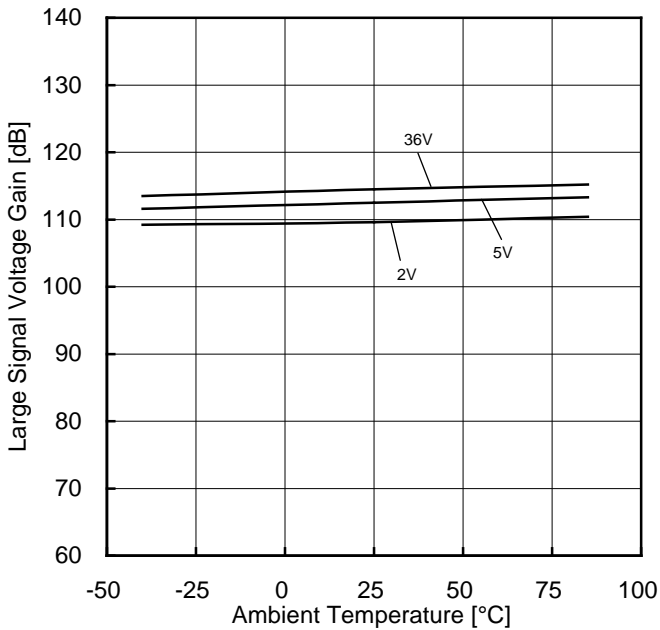

Figure 16.
Large Signal Voltage Gain vs Ambient Temperature

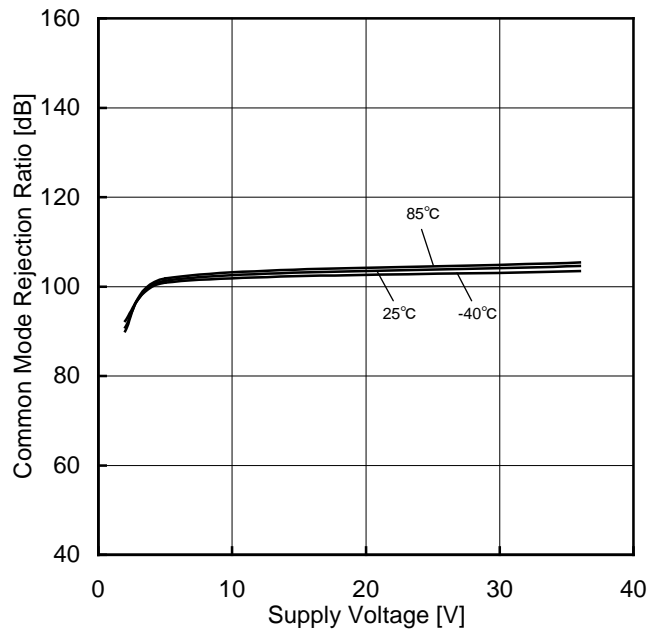

Figure 17.
Common Mode Rejection Ratio vs Supply Voltage

(*The above characteristics are measurements of typical sample, they are not guaranteed.

Typical Performance Curves - continued

OBA8391G

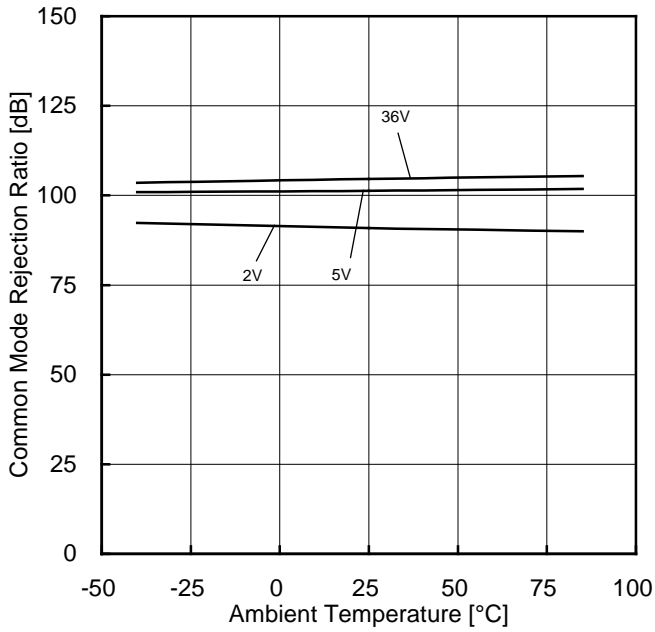

Figure 18.
Common Mode Rejection Ratio vs Ambient Temperature

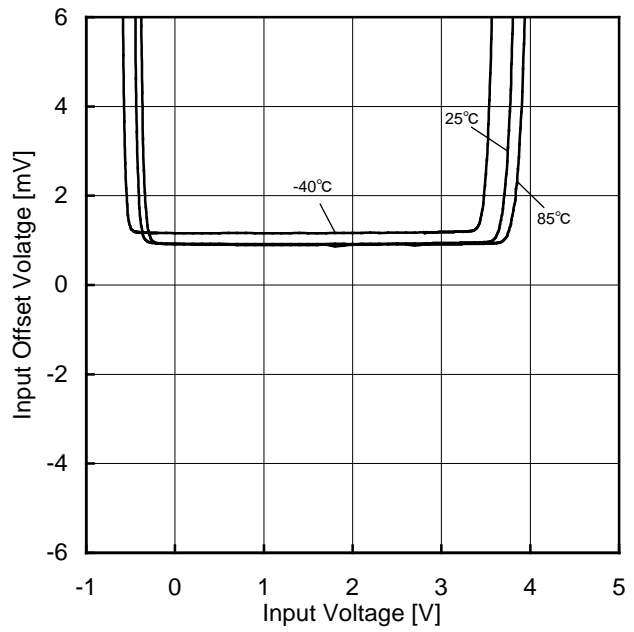

Figure 19.
Input Offset Voltage - Input Voltage (VCC=5V)

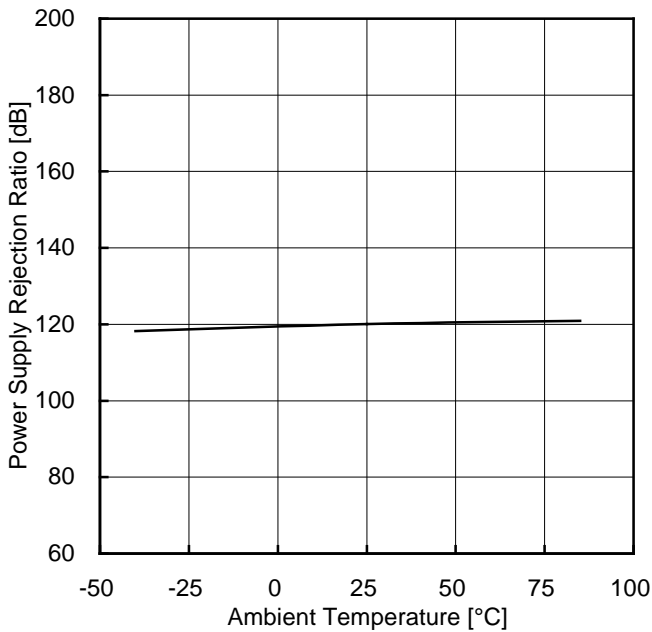

Figure 20.
Power Supply Rejection Ratio vs Ambient Temperature

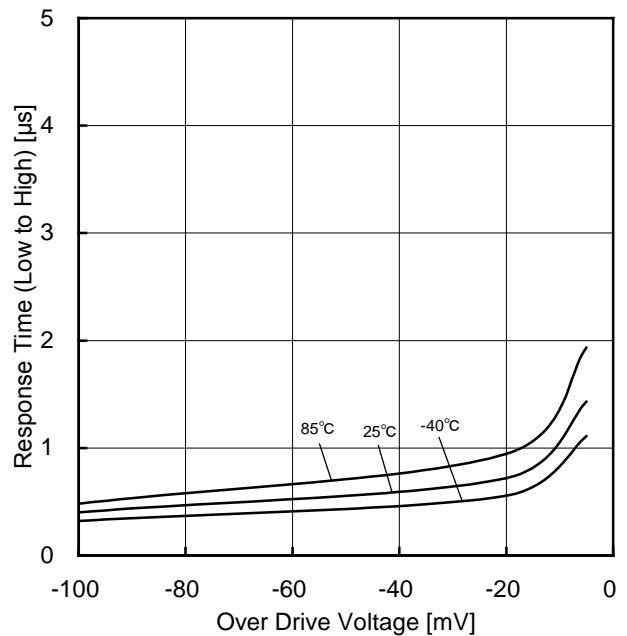

Figure 21.
Response Time (Low to High) vs Over Drive Voltage (VCC=5V, V_{RL}=5V, R_L=5.1kΩ)

(*The above characteristics are measurements of typical sample, they are not guaranteed.

Typical Performance Curves - continued

OBA8391G

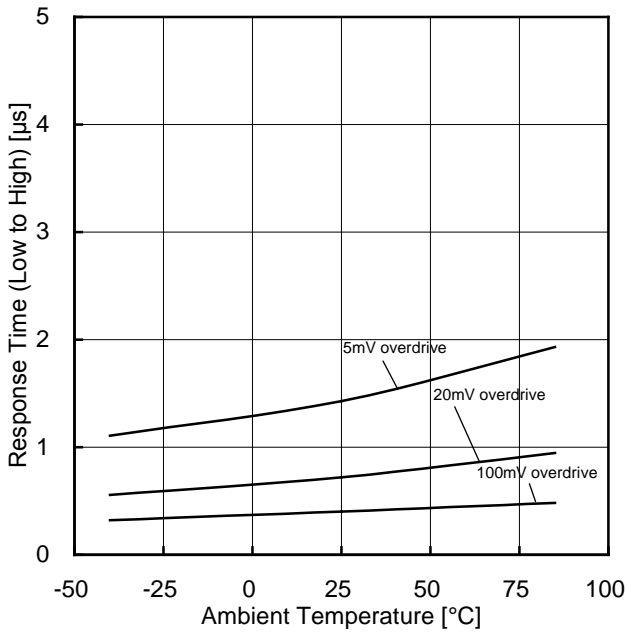

Figure 22.
Response Time (Low to High)
vs Ambient Temperature
(VCC=5V, V_{RL}=5V, R_L=5.1kΩ)

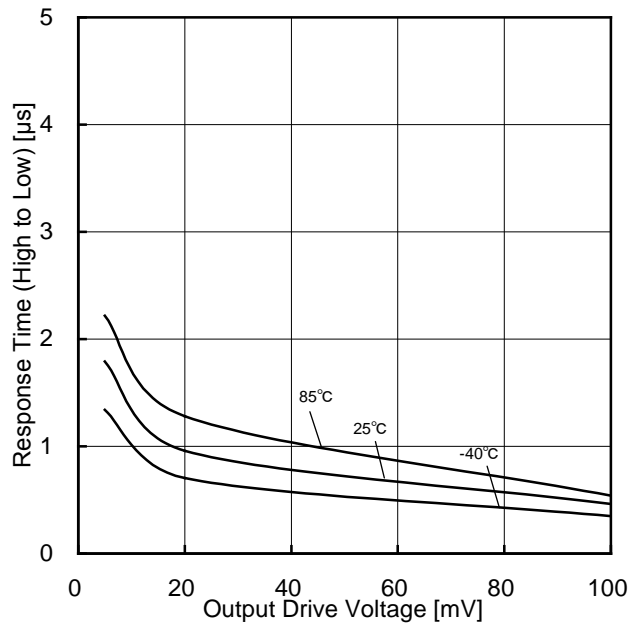

Figure 23.
Response Time (High to Low)
vs Over Drive Voltage
(VCC=5V, V_{RL}=5V, R_L=5.1kΩ)

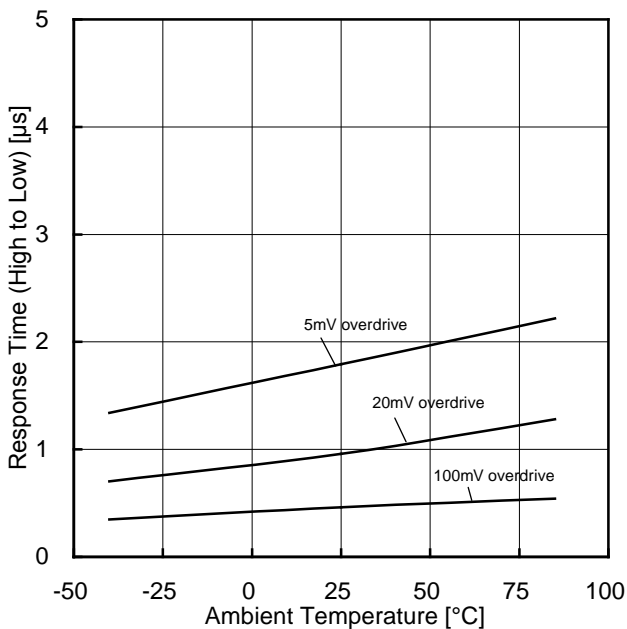

Figure 24.
Response Time (High to Low)
vs Ambient Temperature
(VCC=5V, V_{RL}=5V, R_L=5.1kΩ)

(*)The above characteristics are measurements of typical sample, they are not guaranteed.

Typical Performance Curves - continued

OBA10393F

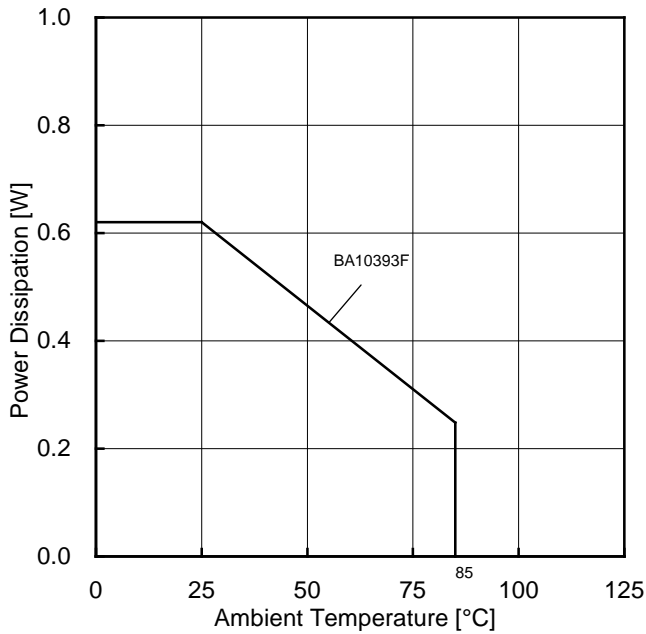

Figure 25.
Power Dissipation vs Ambient Temperature
(Derating Curve)

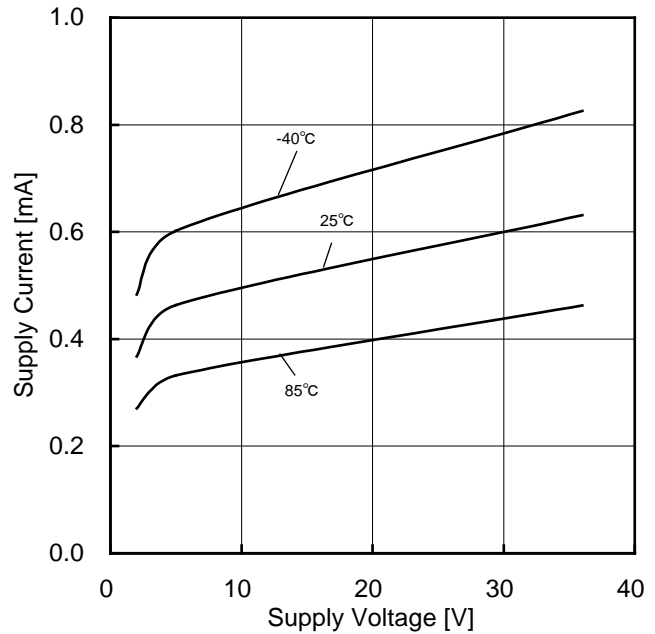

Figure 26.
Supply Current vs Supply Voltage

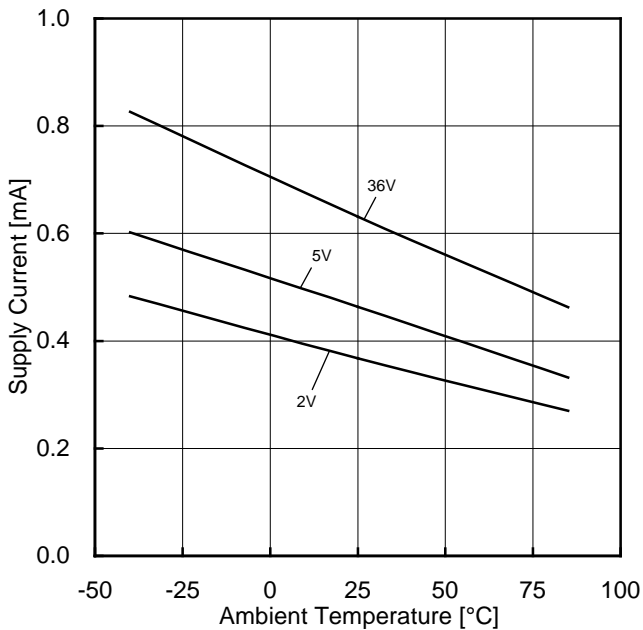

Figure 27.
Supply Current vs Ambient Temperature

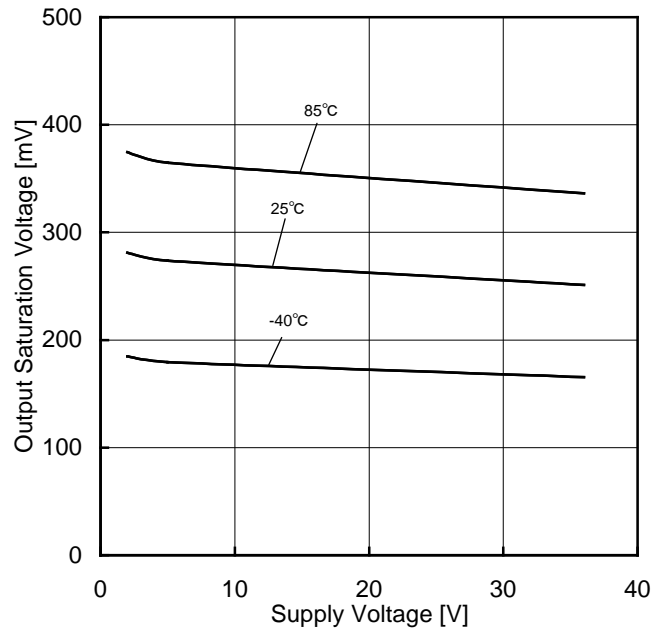

Figure 28.
Output Saturation Voltage vs Supply Voltage
($I_{OL}=4mA$)

(*The above characteristics are measurements of typical sample, they are not guaranteed.

Typical Performance Curves - continued

OBA10393F

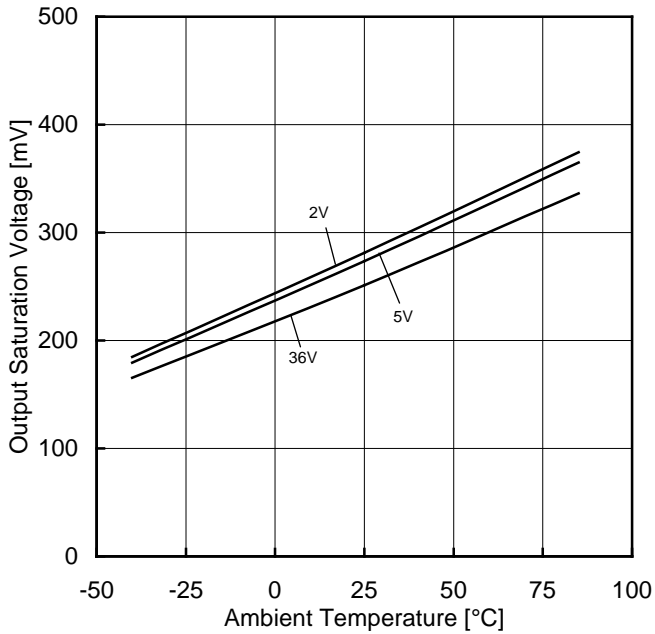

Figure 29.
Output Saturation Voltage vs Ambient Temperature
($I_{OL}=4mA$)

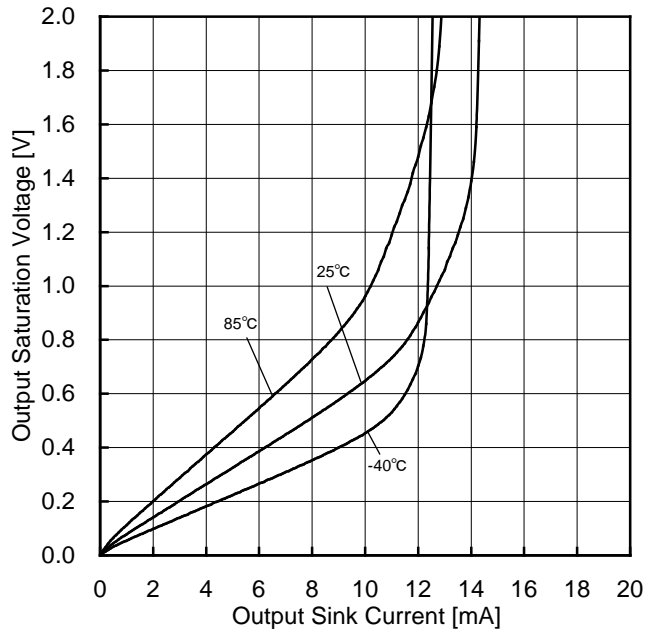

Figure 30.
Output Saturation Voltage vs
Output Sink Current
($V_{CC}=5V$)

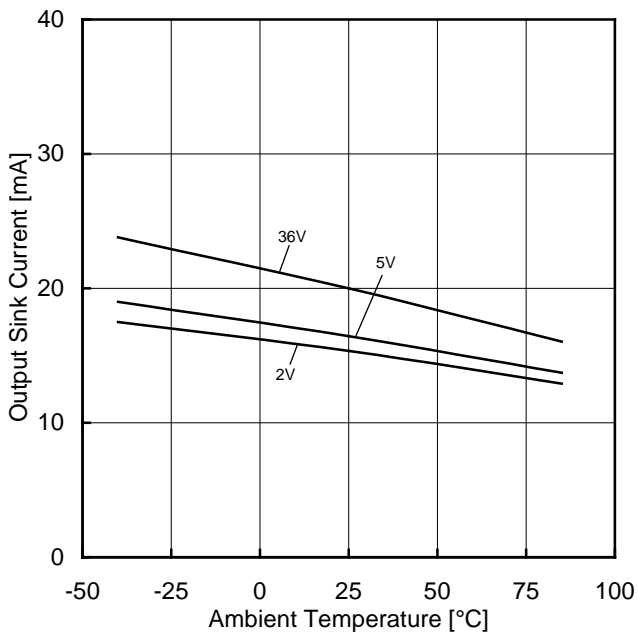

Figure 31.
Output Sink Current vs Ambient Temperature
($OUT=1.5V$)

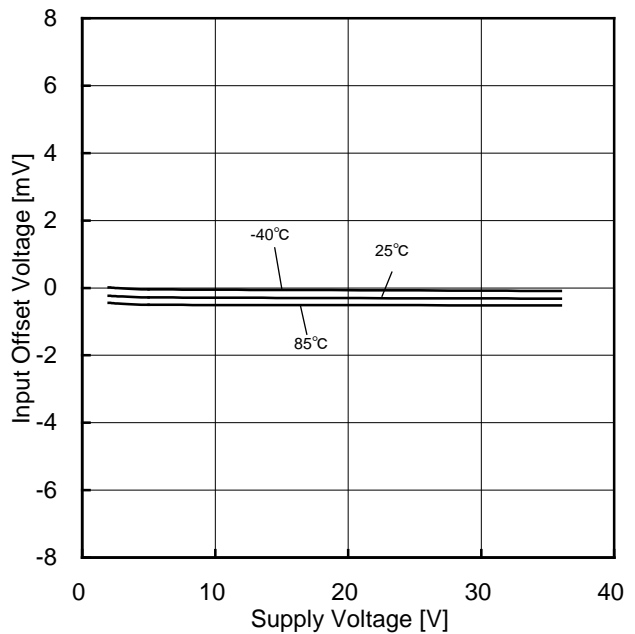

Figure 32.
Input Offset Voltage vs Supply Voltage

(*)The above characteristics are measurements of typical sample, they are not guaranteed.

Typical Performance Curves - continued

OBA10393F

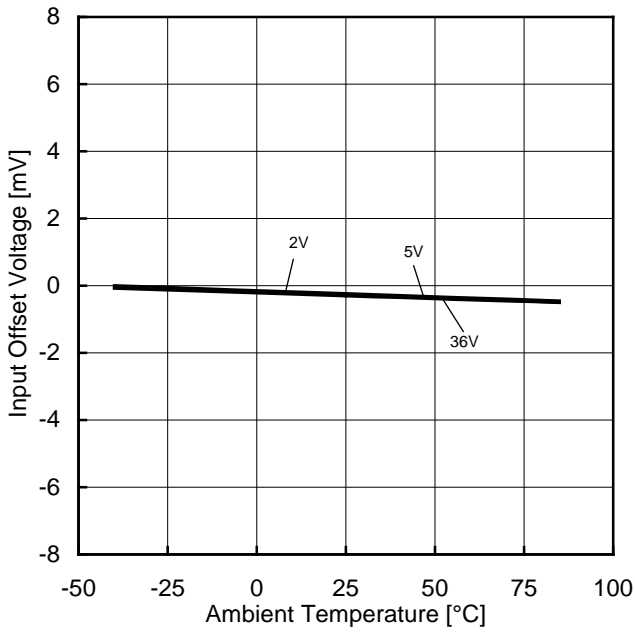

Figure 33.
Input Offset Voltage vs Ambient Temperature

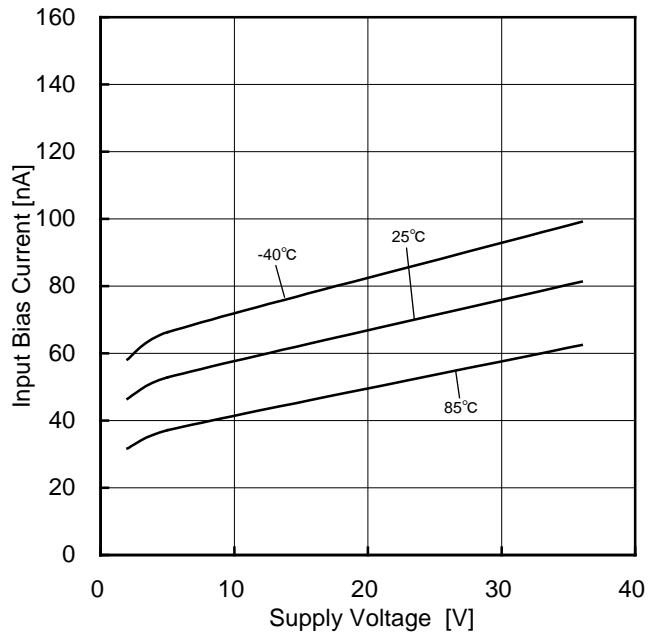

Figure 34.
Input Bias Current vs Supply Voltage

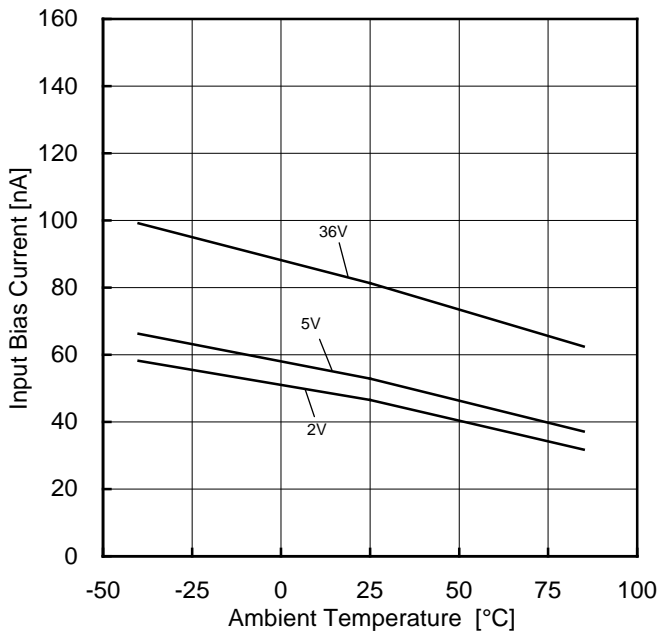

Figure 35.
Input Bias Current vs Ambient Temperature

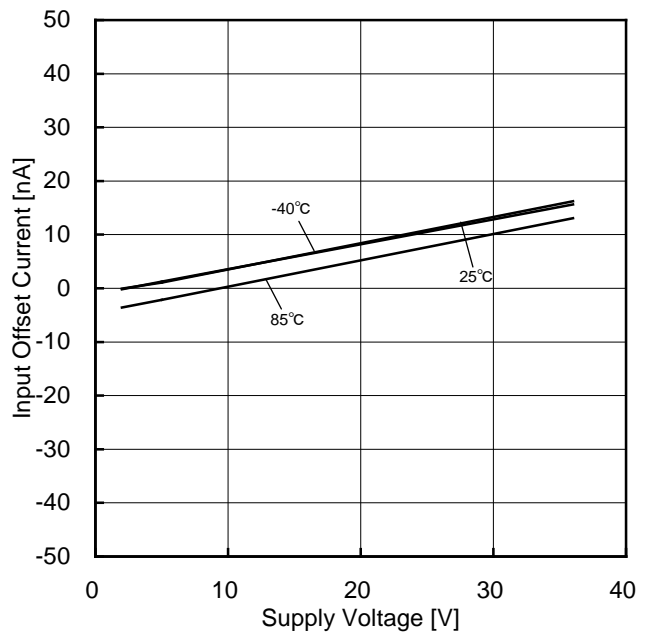

Figure 36.
Input Offset Current vs Supply Voltage

(*)The above characteristics are measurements of typical sample, they are not guaranteed.

Typical Performance Curves - continued

OBA10393F

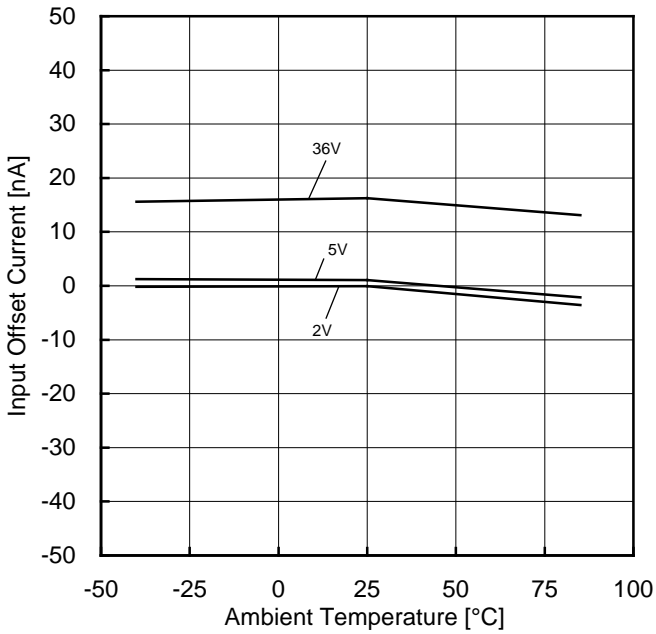

Figure 37.
Input Offset Current vs Ambient Temperature

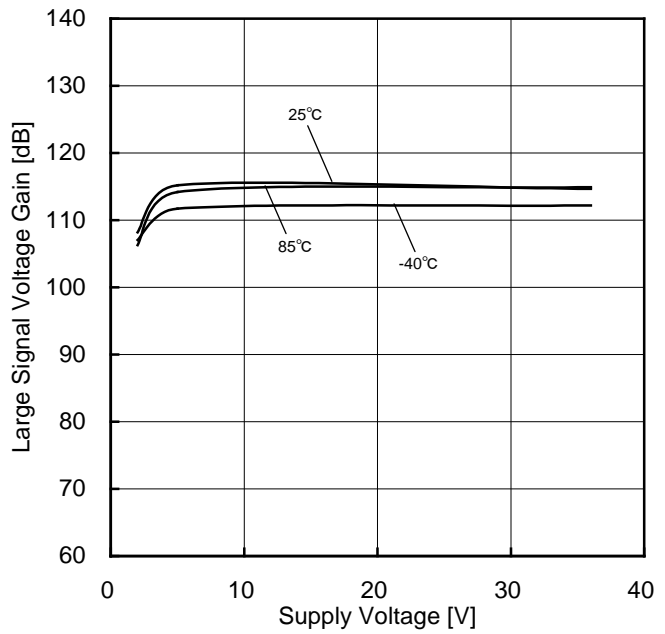

Figure 38.
Large Signal Voltage Gain vs Supply Voltage

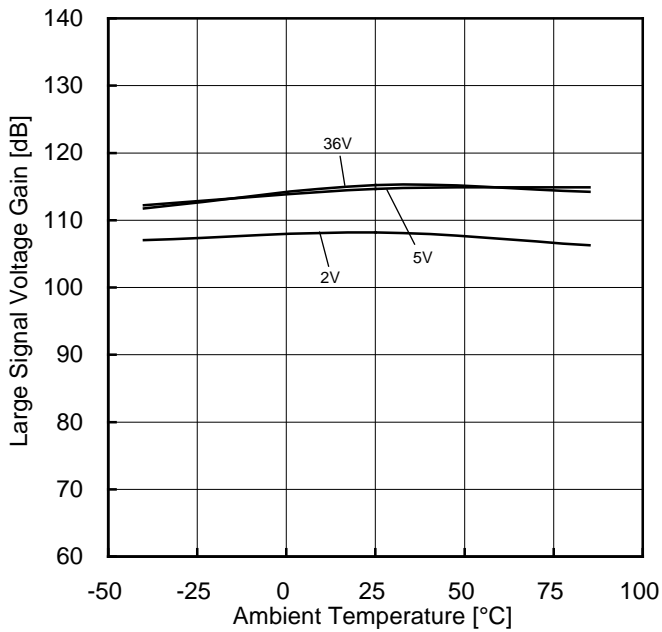

Figure 39.
Large Signal Voltage Gain vs Ambient Temperature

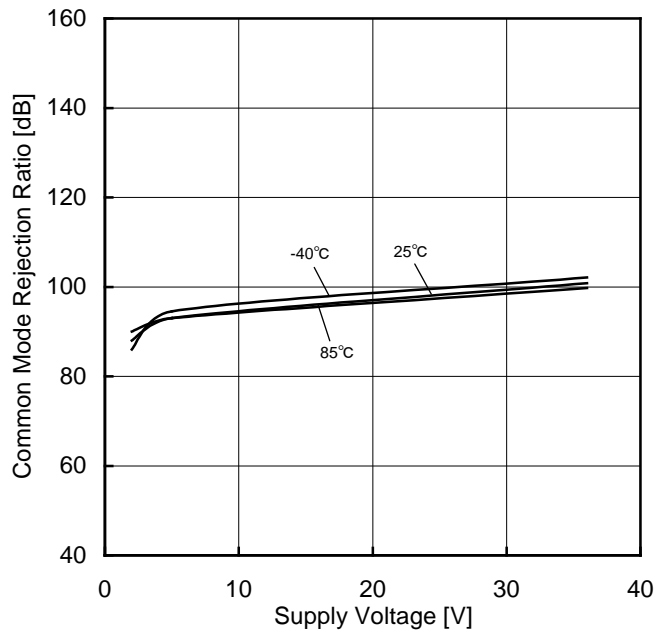

Figure 40.
Common Mode Rejection Ratio vs Supply Voltage

(*)The above characteristics are measurements of typical sample, they are not guaranteed.

Typical Performance Curves - continued

OBA10393F

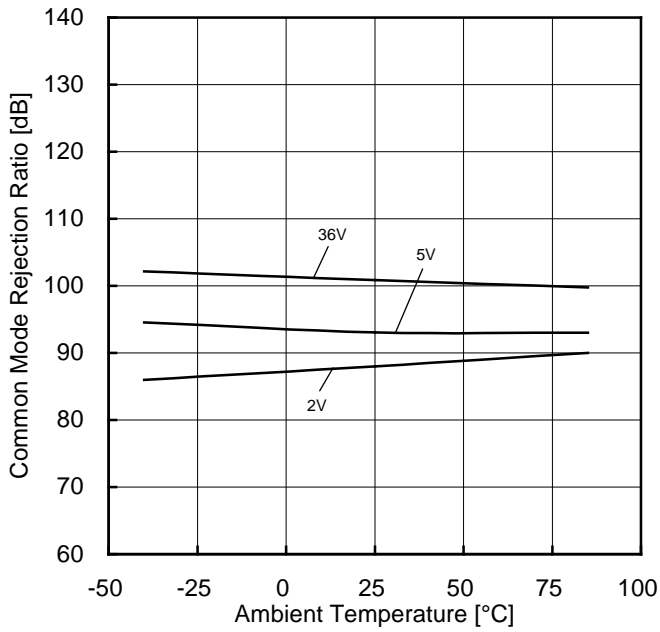

Figure 41.
Common Mode Rejection Ratio vs Ambient Temperature

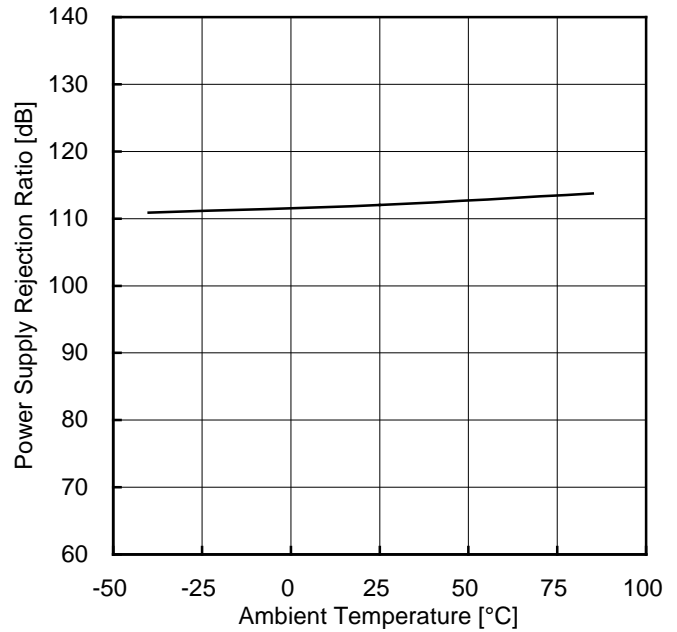

Figure 42.
Power Supply Rejection Ratio vs Ambient Temperature

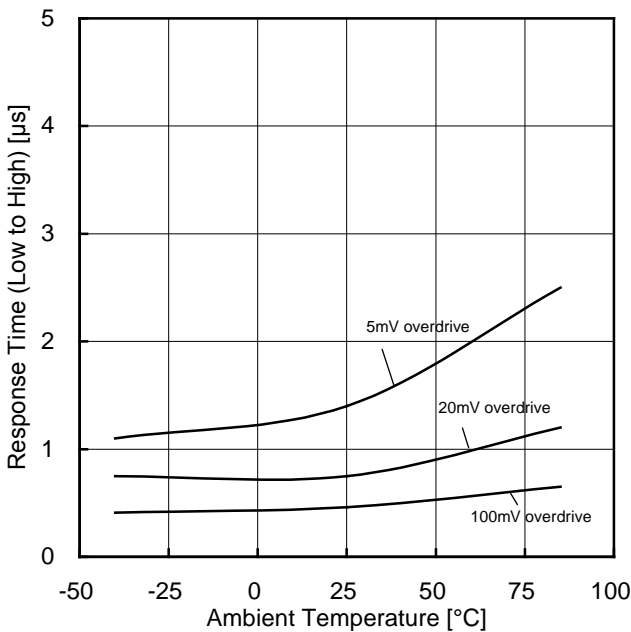

Figure 43.
Response Time (Low to High) vs Ambient Temperature
(VCC=5V, V_{RL}=5V, R_L=5.1kΩ)

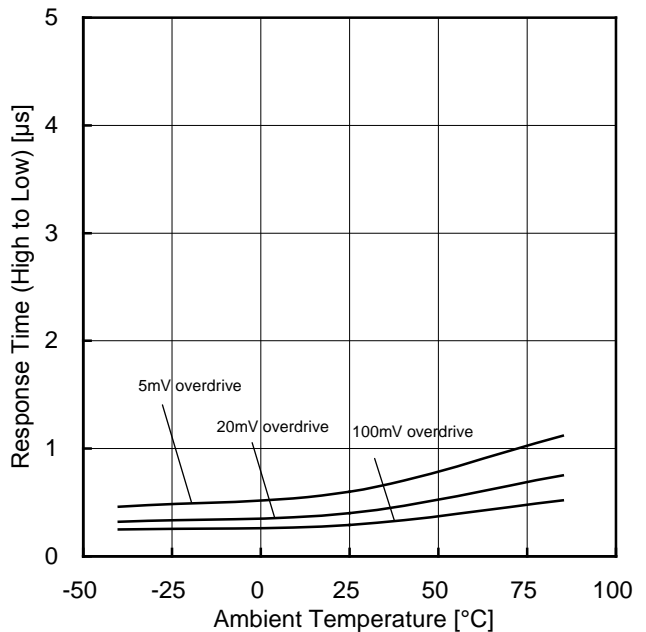

Figure 44.
Response Time (High to Low) vs Ambient Temperature
(VCC=5V, V_{RL}=5V, R_L=5.1kΩ)

(*)The above characteristics are measurements of typical sample, they are not guaranteed.

Typical Performance Curves - continued

OBA10339xx

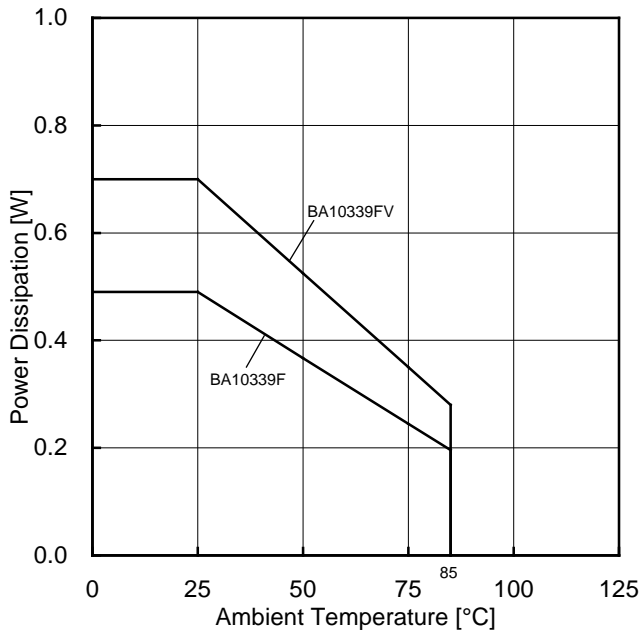

Figure 45.
Power Dissipation vs Ambient Temperature
(Derating Curve)

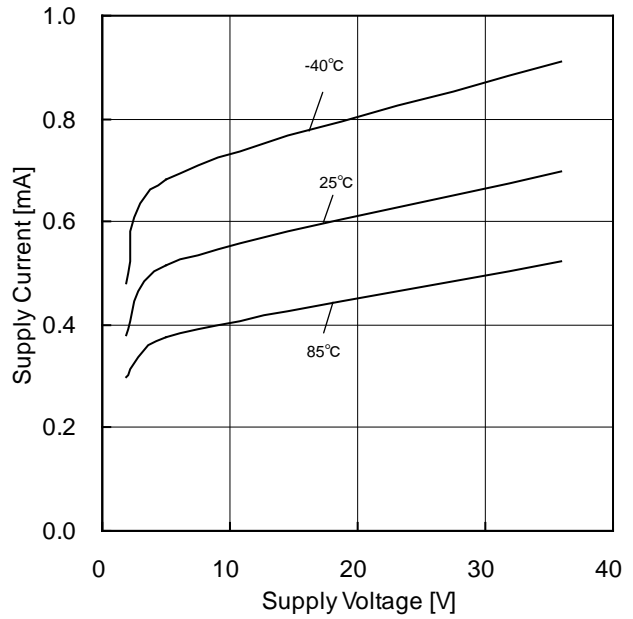

Figure 46.
Supply Current vs Supply Voltage

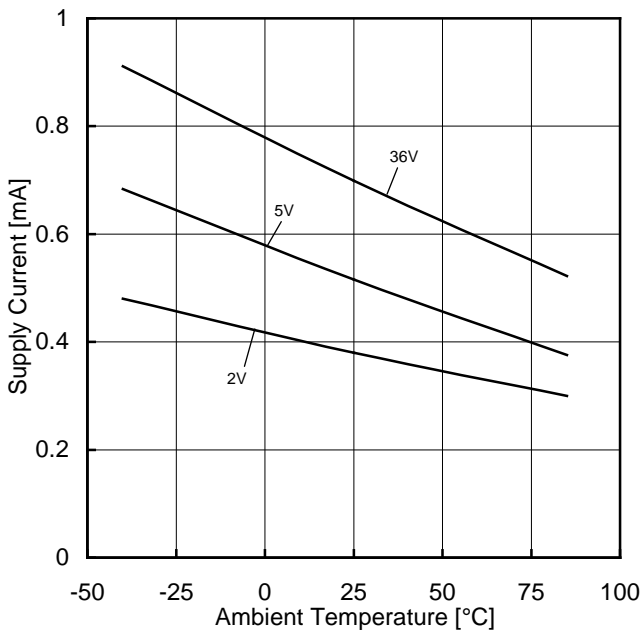

Figure 47.
Supply Current vs Ambient Temperature

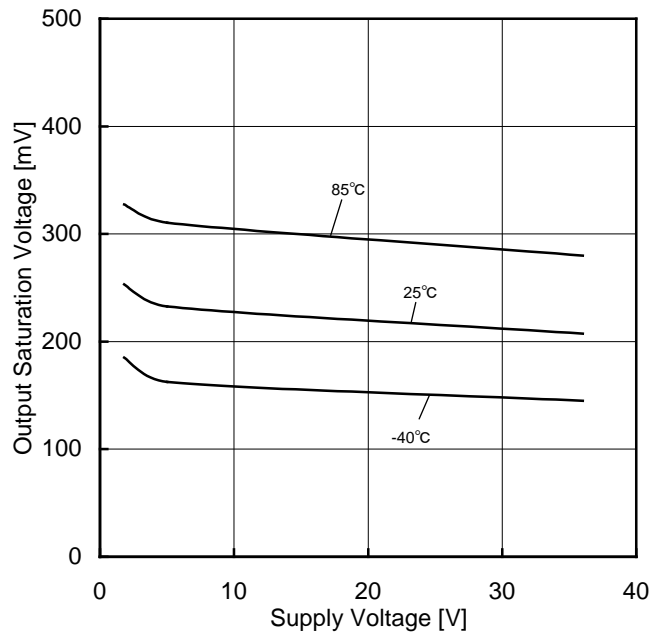

Figure 48.
Output Saturation Voltage vs Supply Voltage
($I_{OL}=4mA$)

(*)The above characteristics are measurements of typical sample, they are not guaranteed.

Typical Performance Curves - continued

OBA10339xx

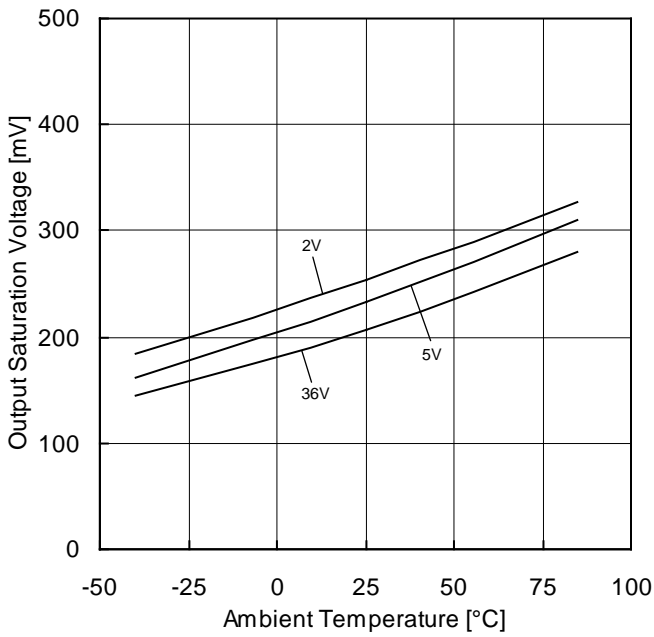

Figure 49.
Output Saturation Voltage vs Ambient Temperature
($I_{OL}=4mA$)

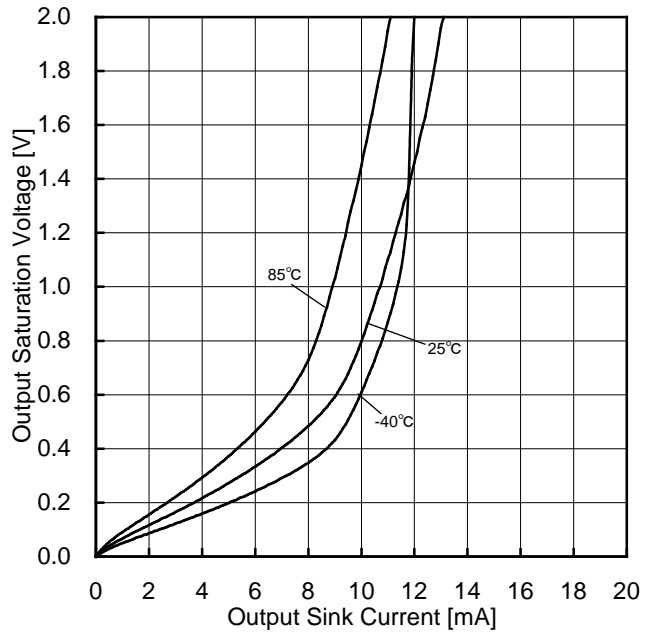

Figure 50.
Output Saturation Voltage vs
Output Sink Current
($V_{CC}=5V$)

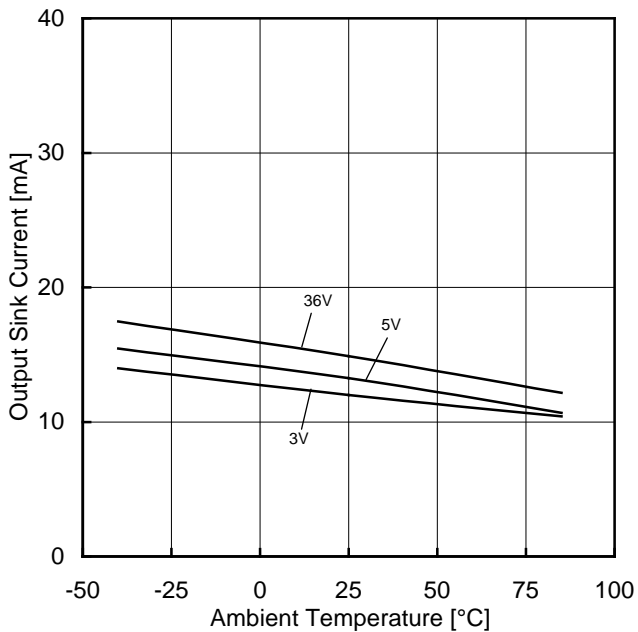

Figure 51.
Output Sink Current vs Ambient Temperature
($OUT=1.5V$)

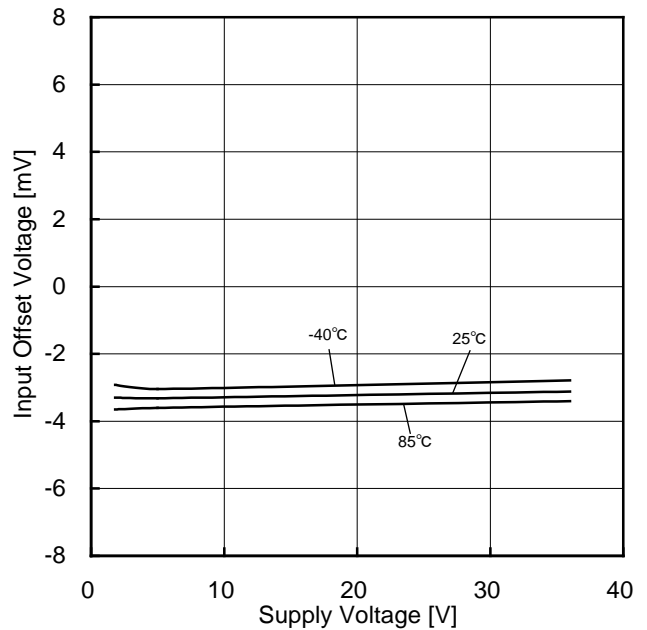

Figure 52.
Input Offset Voltage vs Supply Voltage

(*)The above characteristics are measurements of typical sample, they are not guaranteed.

Typical Performance Curves - continued

OBA10339xx

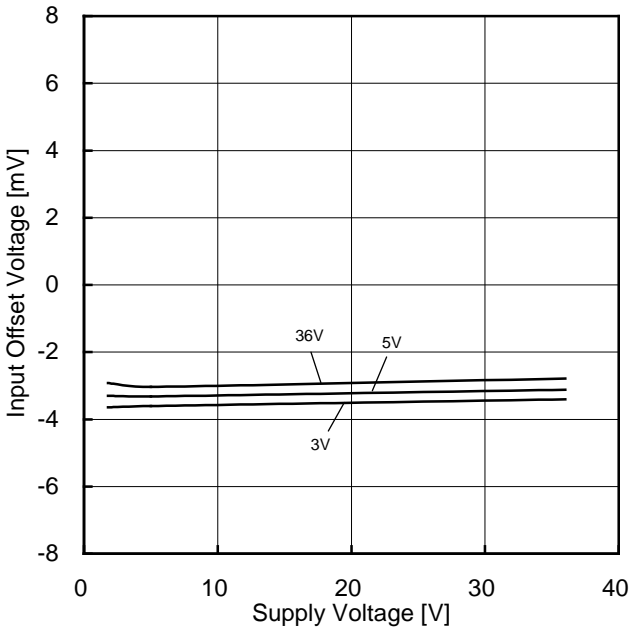

Figure 53.
Input Offset Voltage vs Ambient Temperature

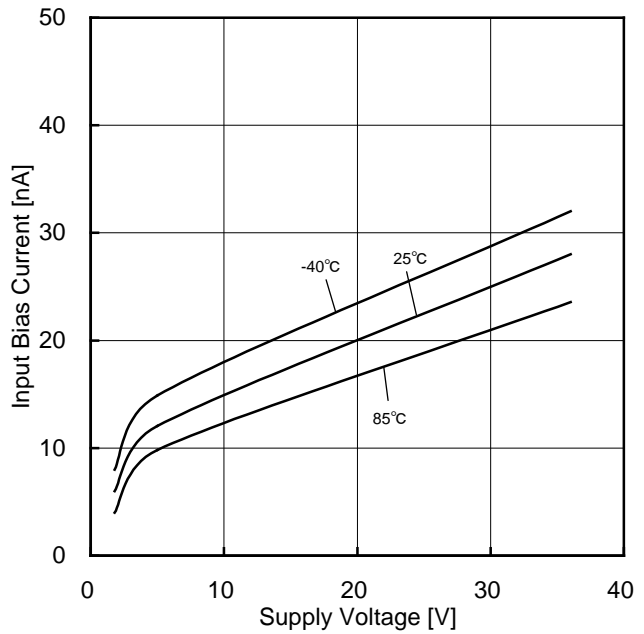

Figure 54.
Input Bias Current vs Supply Voltage

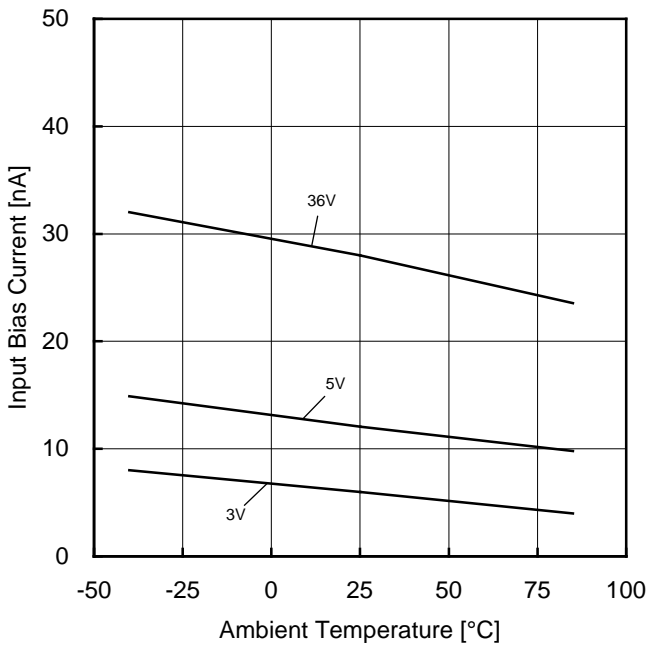

Figure 55.
Input Bias Current vs Ambient Temperature

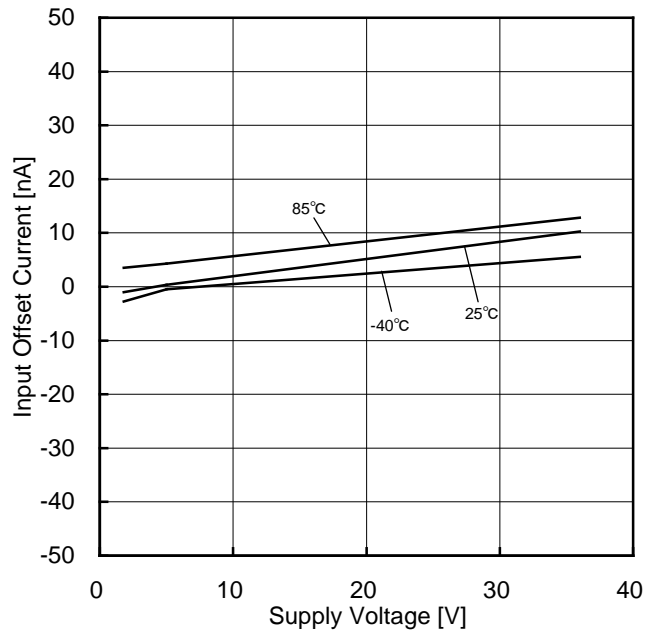

Figure 56.
Input Offset Current vs Supply Voltage

(*)The above characteristics are measurements of typical sample, they are not guaranteed.

Typical Performance Curves - continued

OBA10339xx

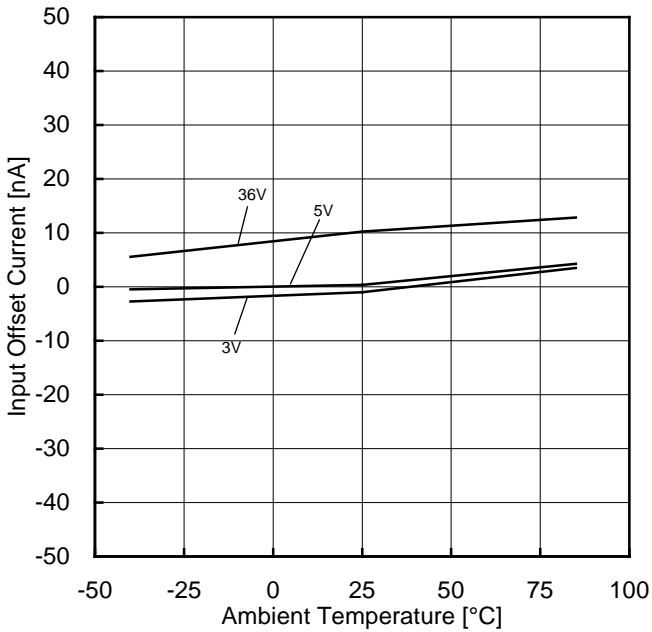

Figure 57.
Input Offset Current vs Ambient Temperature

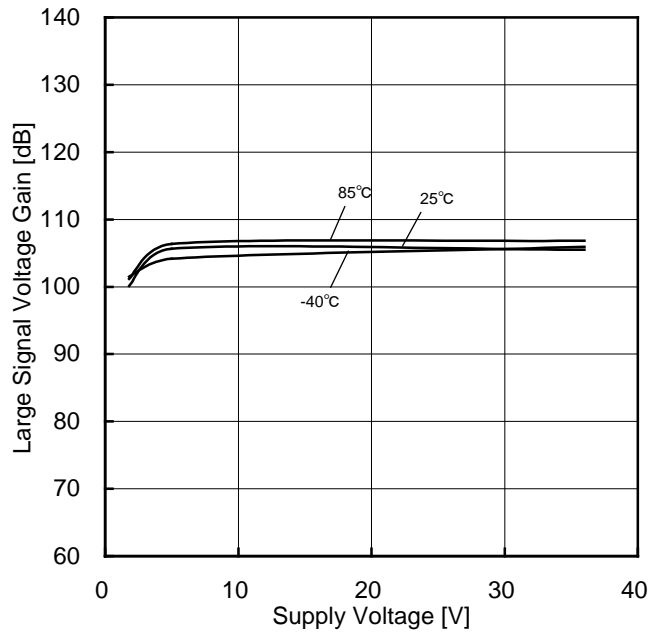

Figure 58.
Large Signal Voltage Gain vs Supply Voltage

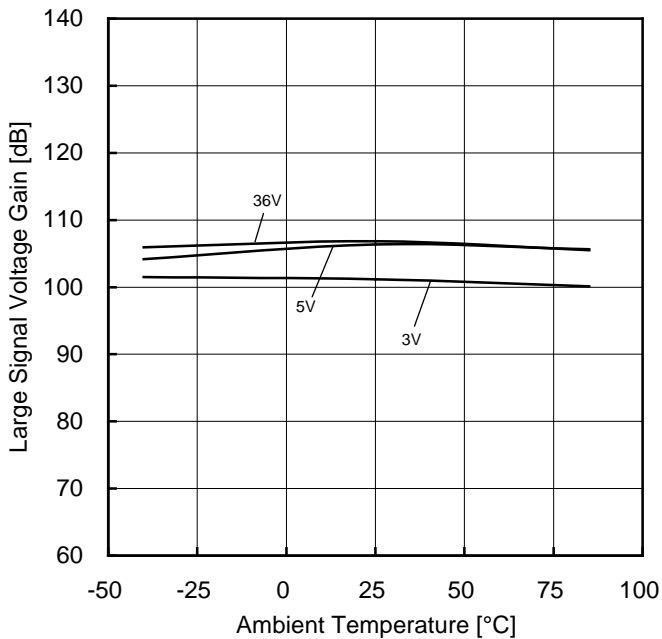

Figure 59.
Large Signal Voltage Gain vs Ambient Temperature

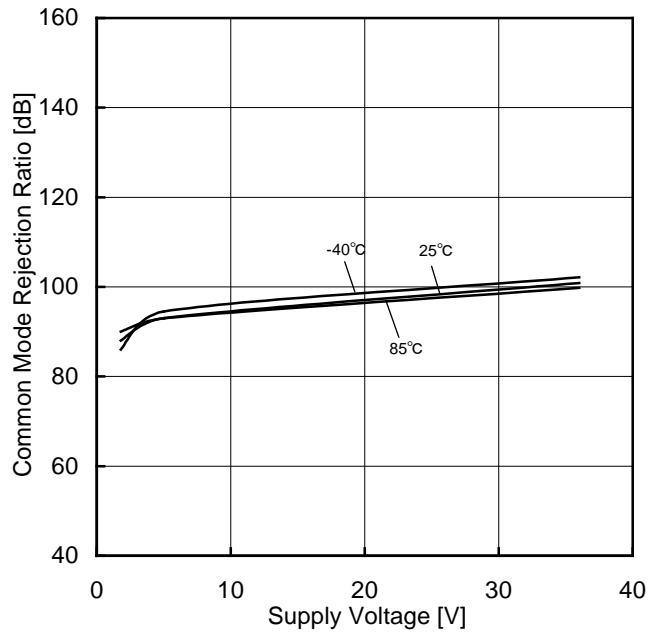

Figure 60.
Common Mode Rejection Ratio vs Supply Voltage

(*)The above characteristics are measurements of typical sample, they are not guaranteed.

Typical Performance Curves - continued

OBA10339xx

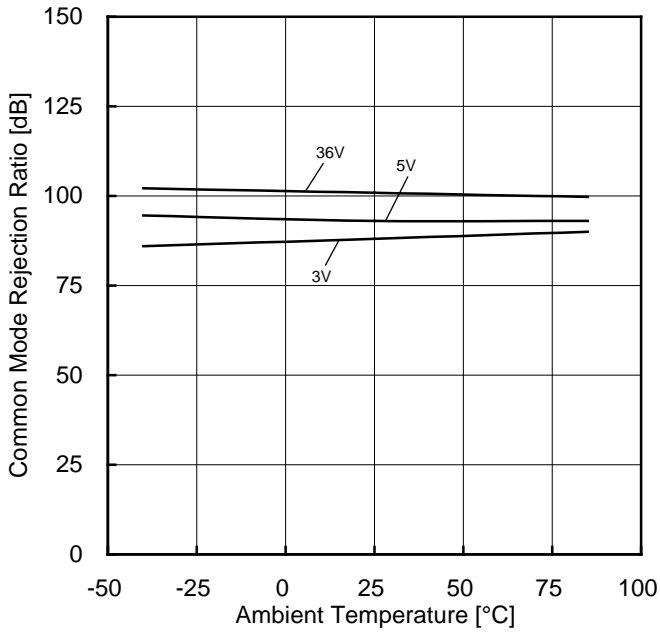

Figure 61.
Common Mode Rejection Ratio vs Ambient Temperature

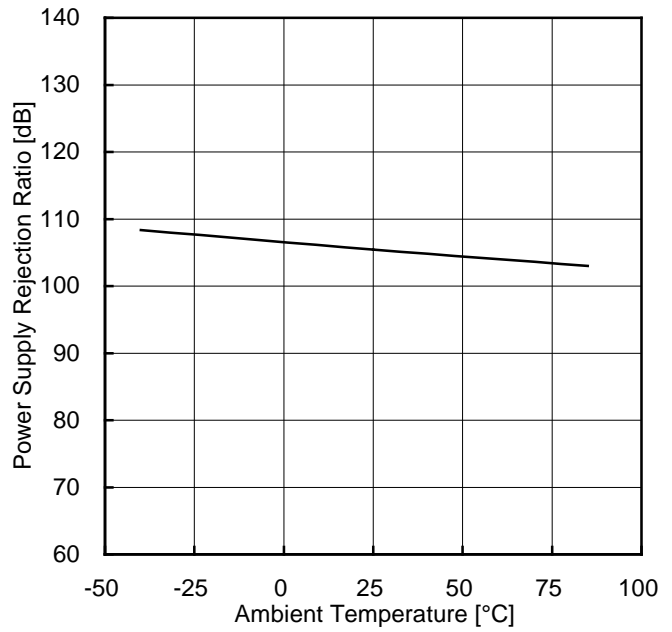

Figure 62.
Power Supply Rejection Ratio vs Ambient Temperature

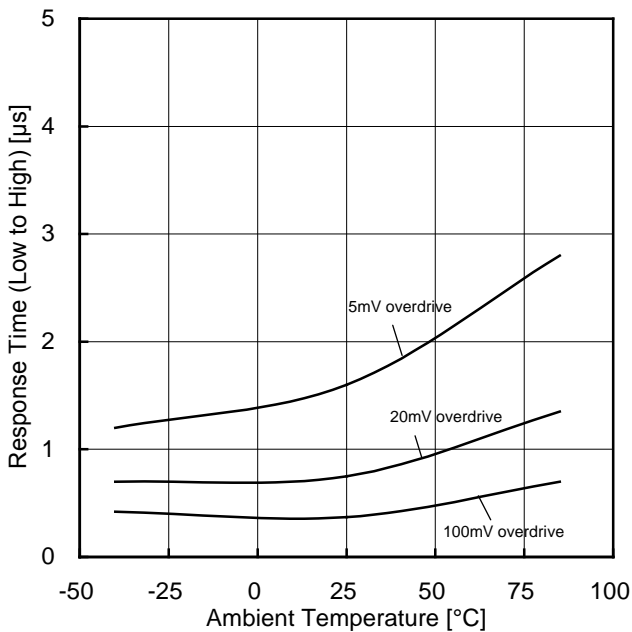

Figure 63.
Response Time (Low to High) vs Ambient Temperature
(VCC=5V, V_{RL}=5V, R_L=5.1kΩ)

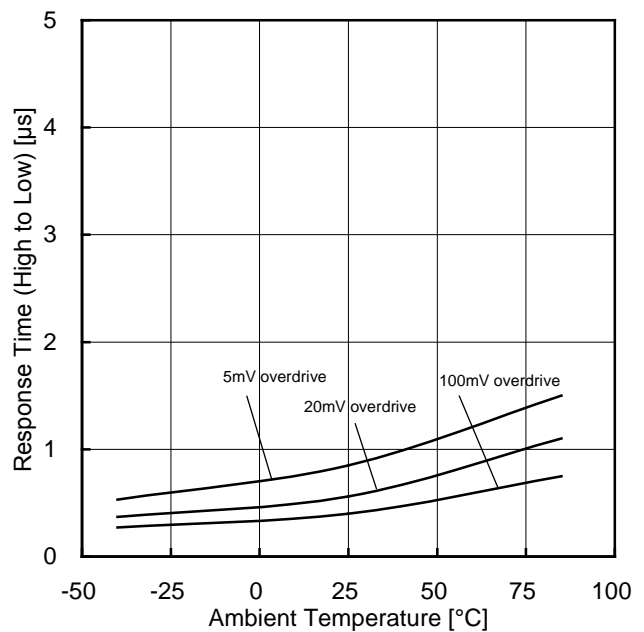

Figure 64.
Response Time (High to Low) vs Ambient Temperature
(VCC=5V, V_{RL}=5V, R_L=5.1kΩ)

(*)The above characteristics are measurements of typical sample, they are not guaranteed.

Typical Performance Curves - continued

OBA2903xxx, BA2903Sxxx, BA2903Wxx

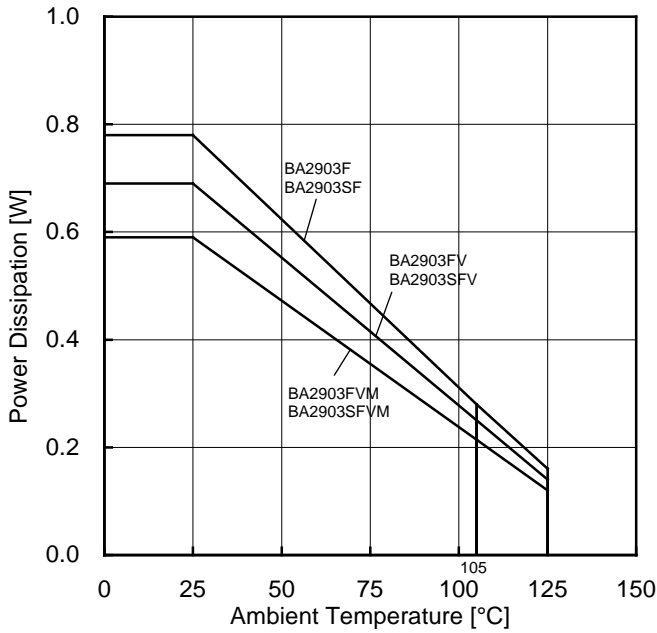

Figure 65.
Power Dissipation vs Ambient Temperature
(Derating Curve)
(Refer to the following operating temperature)

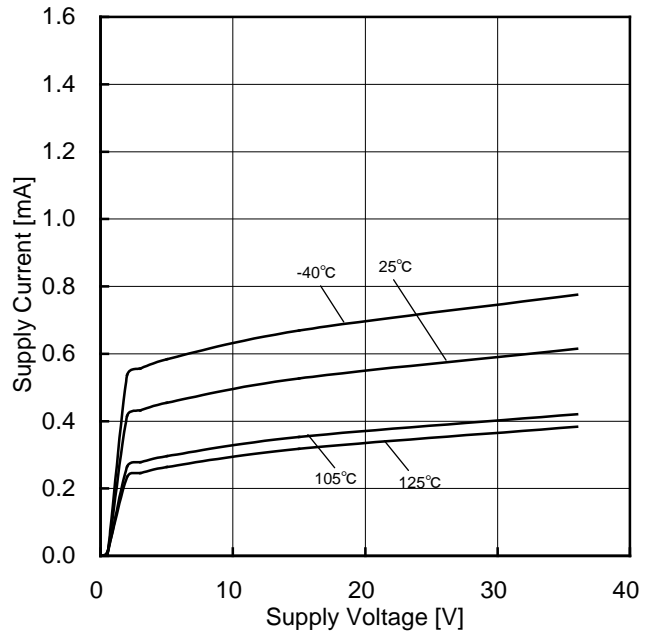

Figure 66.
Supply Current vs Supply Voltage

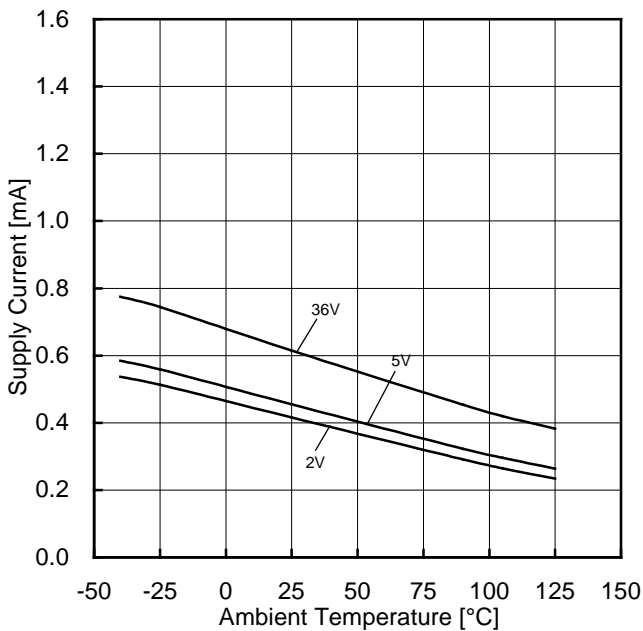

Figure 67.
Supply Current vs Ambient Temperature

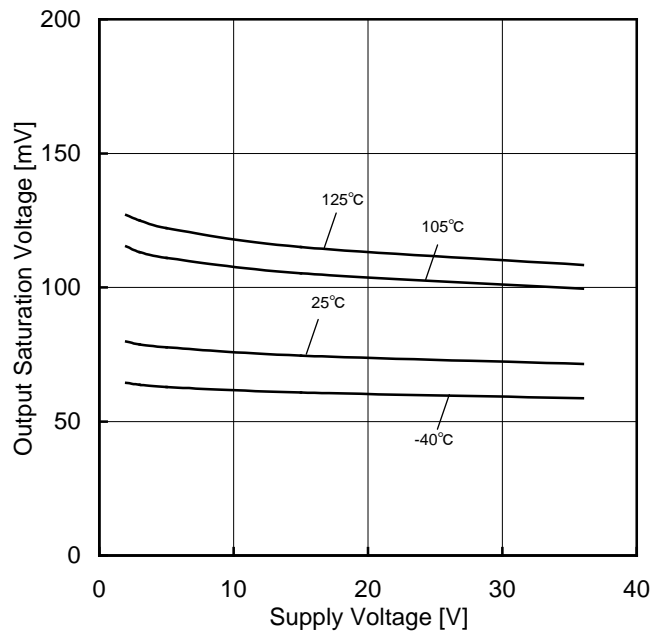

Figure 68.
Output Saturation Voltage vs Supply Voltage
($I_{OL}=4mA$)

(*)The above characteristics are measurements of typical sample, they are not guaranteed.

BA2903 : -40°C to +125°C BA2903S : -40°C to +105°C BA2903W : -40°C to +125°C

Typical Performance Curves - continued

OBA2903xxx, BA2903Sxxx, BA2903Wxx

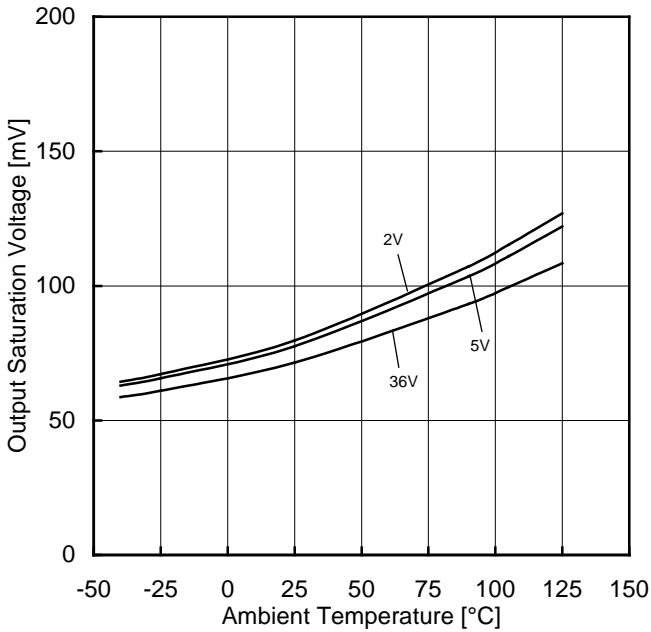

Figure 69.
Output Saturation Voltage vs Ambient Temperature
($I_{OL}=4mA$)

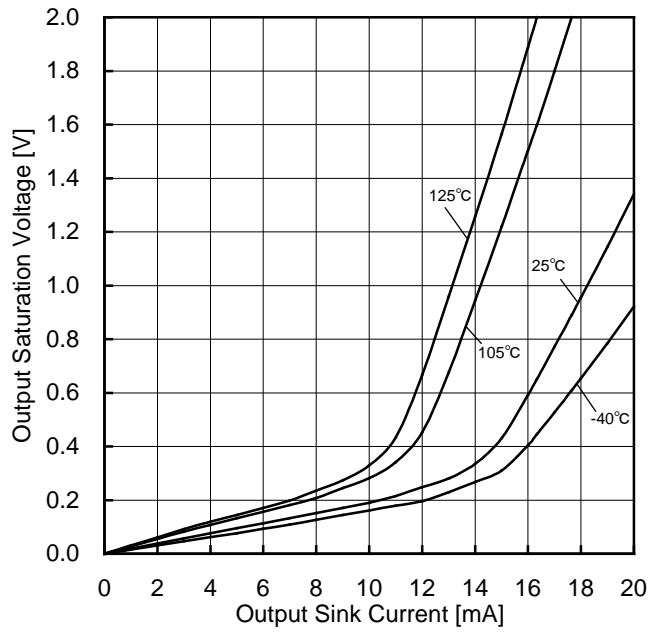

Figure 70.
Output Saturation Voltage vs
Output Sink Current
($V_{CC}=5V$)

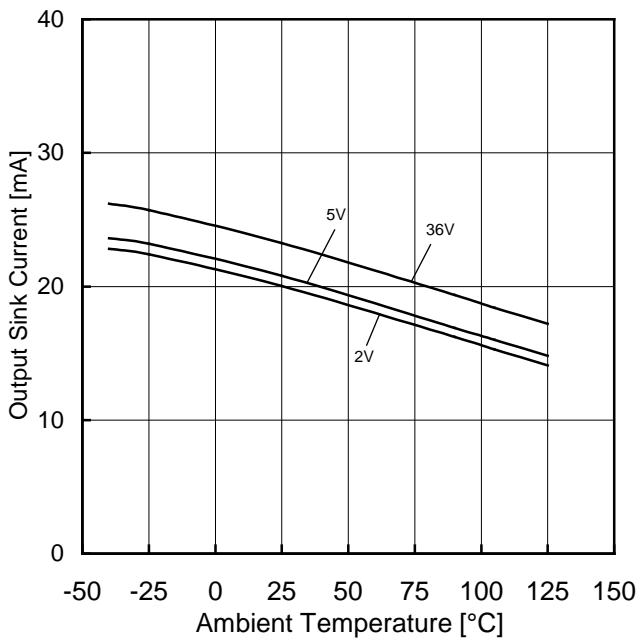

Figure 71.
Output Sink Current vs Ambient Temperature
($OUT=1.5V$)

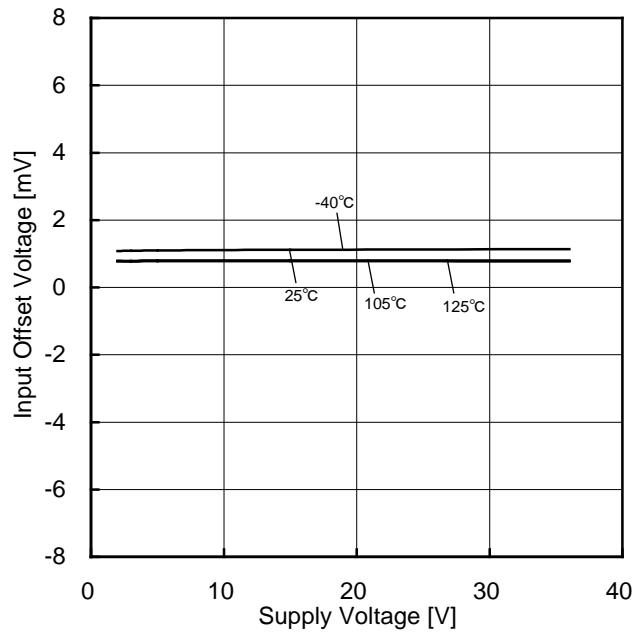

Figure 72.
Input Offset Voltage vs Supply Voltage

(*)The above characteristics are measurements of typical sample, they are not guaranteed.

BA2903 : -40°C to +125°C BA2903S : -40°C to +105°C BA2903W : -40°C to +125°C

Typical Performance Curves - continued

OBA2903xxx, BA2903Sxxx, BA2903Wxx

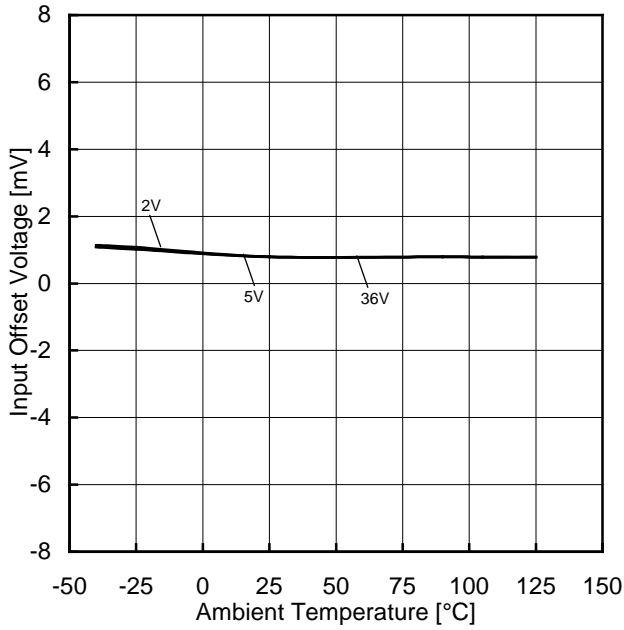

Figure 73.
Input Offset Voltage vs Ambient Temperature

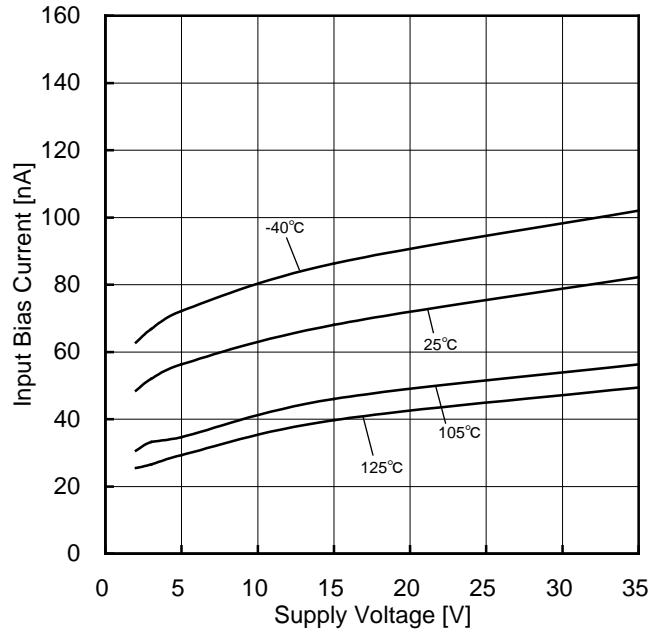

Figure 74.
Input Bias Current vs Supply Voltage

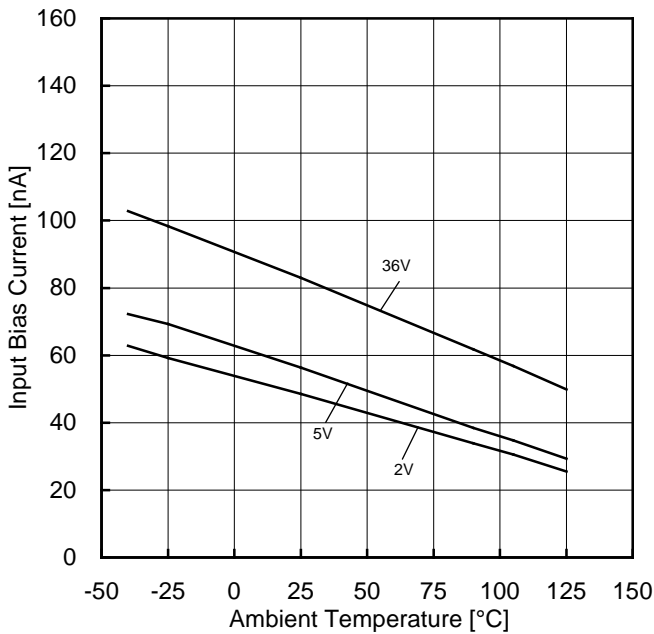

Figure 75.
Input Bias Current vs Ambient Temperature

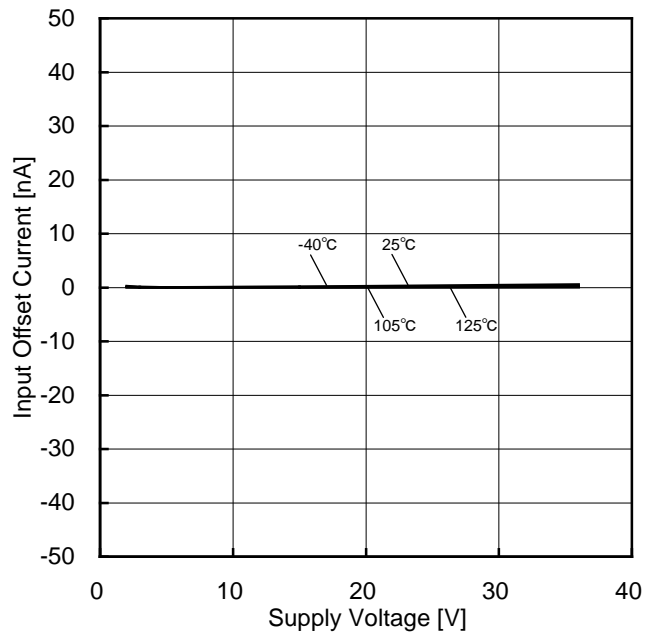

Figure 76.
Input Offset Current vs Supply Voltage

(*)The above characteristics are measurements of typical sample, they are not guaranteed.

BA2903 : -40°C to +125°C BA2903S : -40°C to +105°C BA2903W : -40°C to +125°C

Typical Performance Curves - continued

OBA2903xxx, BA2903Sxxx, BA2903Wxx

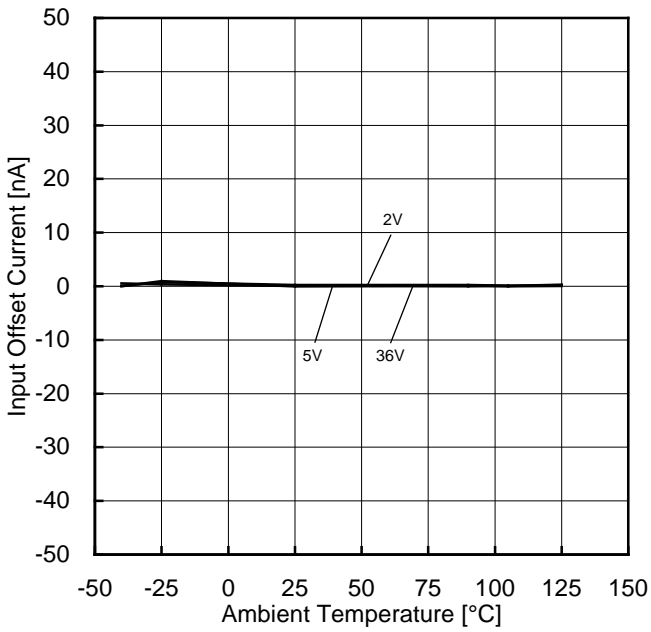

Figure 77.
Input Offset Current vs Ambient Temperature

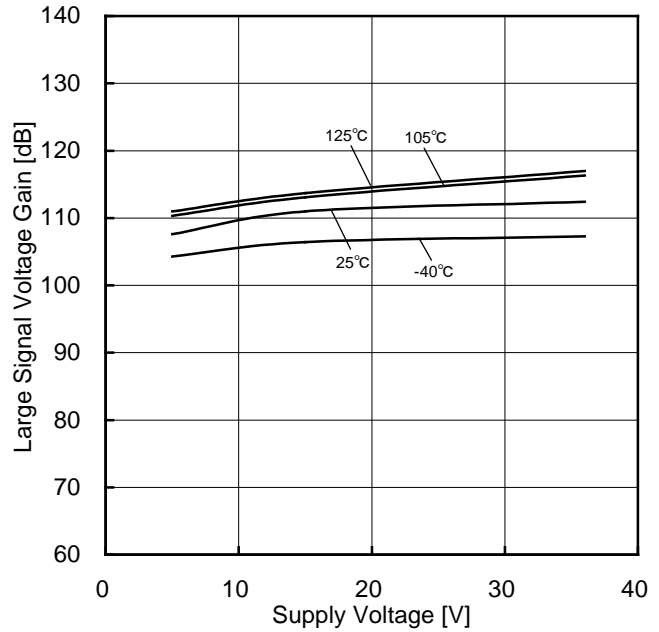

Figure 78.
Large Signal Voltage Gain vs Supply Voltage

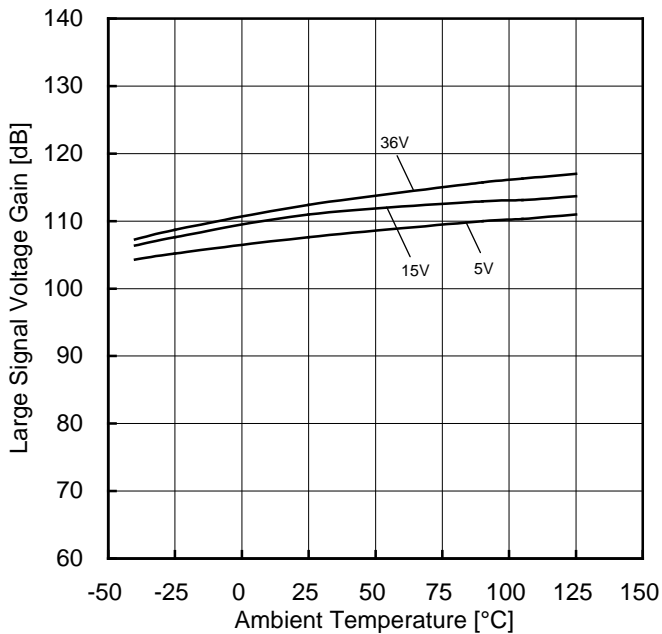

Figure 79.
Large Signal Voltage Gain vs Ambient Temperature

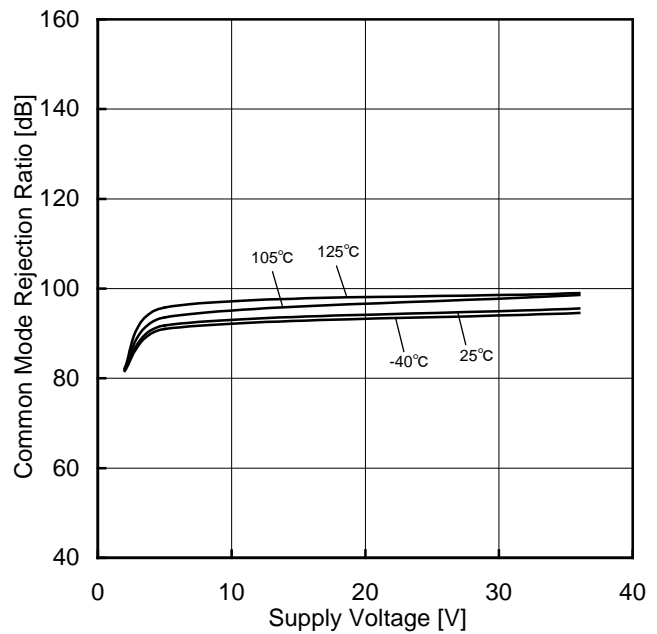

Figure 80.
Common Mode Rejection Ratio vs Supply Voltage

(*)The above characteristics are measurements of typical sample, they are not guaranteed.

BA2903 : -40°C to +125°C BA2903S : -40°C to +105°C BA2903W : -40°C to +125°C

Typical Performance Curves - continued

OBA2903xxx, BA2903Sxxx, BA2903Wxx

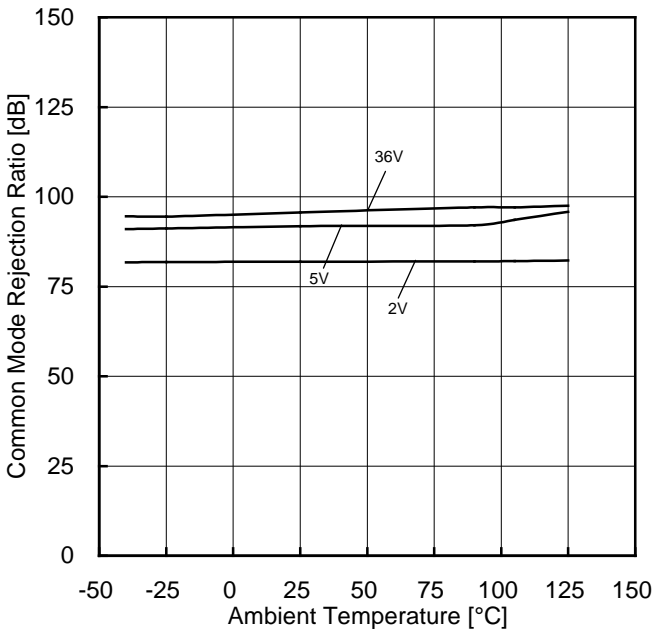

Figure 81.
Common Mode Rejection Ratio vs Ambient Temperature

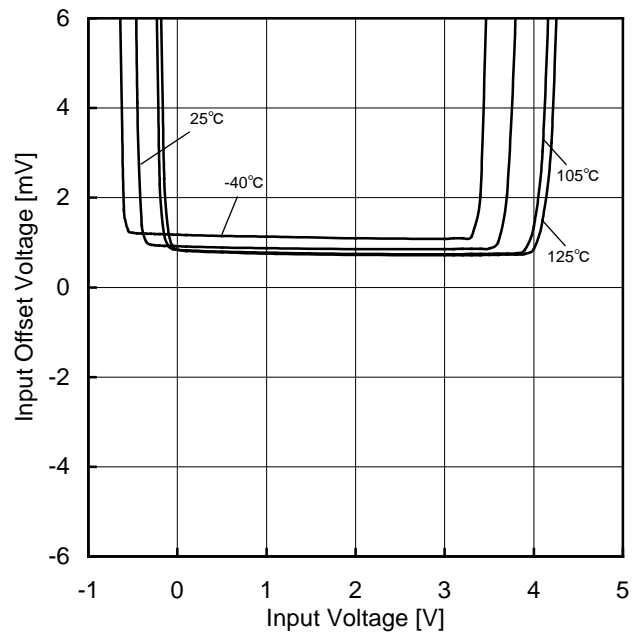

Figure 82.
Input Offset Voltage - Input Voltage (VCC=5V)

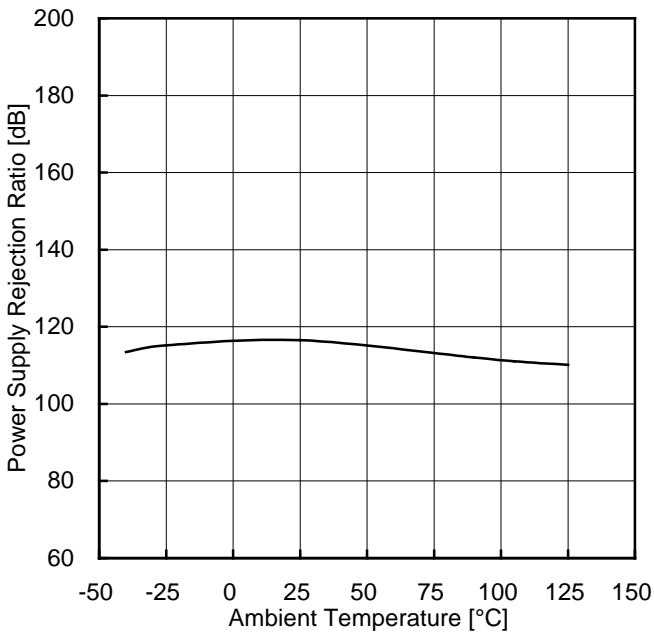

Figure 83.
Power Supply Rejection Ratio vs Ambient Temperature

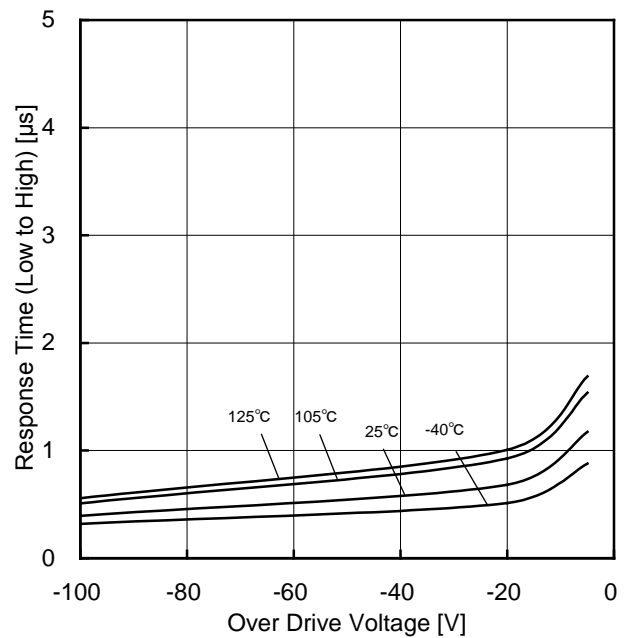

Figure 84.
Response Time (Low to High) vs Over Drive Voltage (VCC=5V, V_{RL}=5V, R_L=5.1kΩ)

(*)The above characteristics are measurements of typical sample, they are not guaranteed.

BA2903 : -40°C to +125°C BA2903S : -40°C to +105°C BA2903W : -40°C to +125°C

Typical Performance Curves - continued

OBA2903xxx, BA2903Sxxx, BA2903Wxx

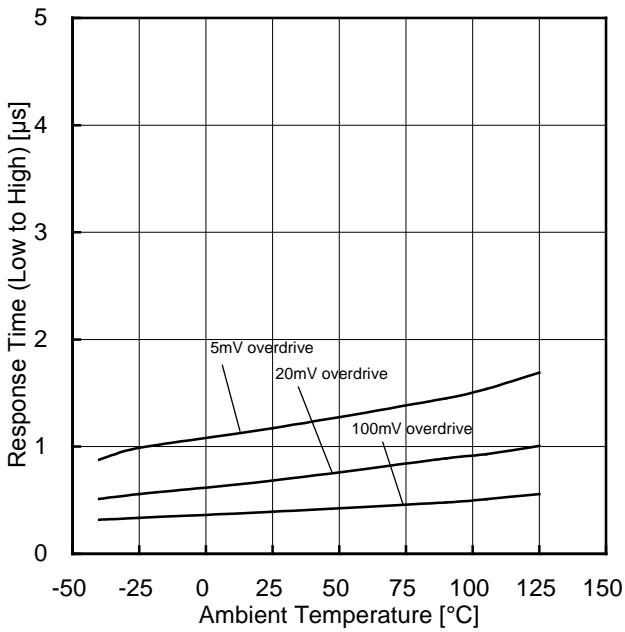

Figure 85.
Response Time (Low to High)
vs Ambient Temperature
(VCC=5V, V_{RL}=5V, R_L=5.1kΩ)

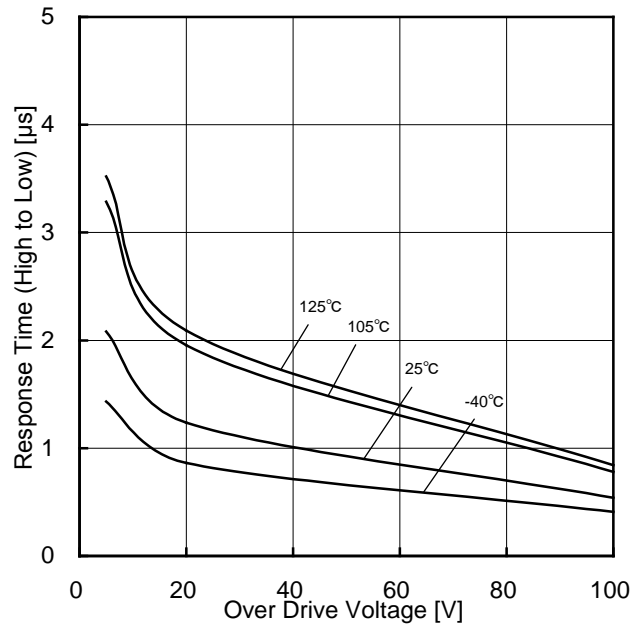

Figure 86.
Response Time (High to Low)
vs Over Drive Voltage
(VCC=5V, V_{RL}=5V, R_L=5.1kΩ)

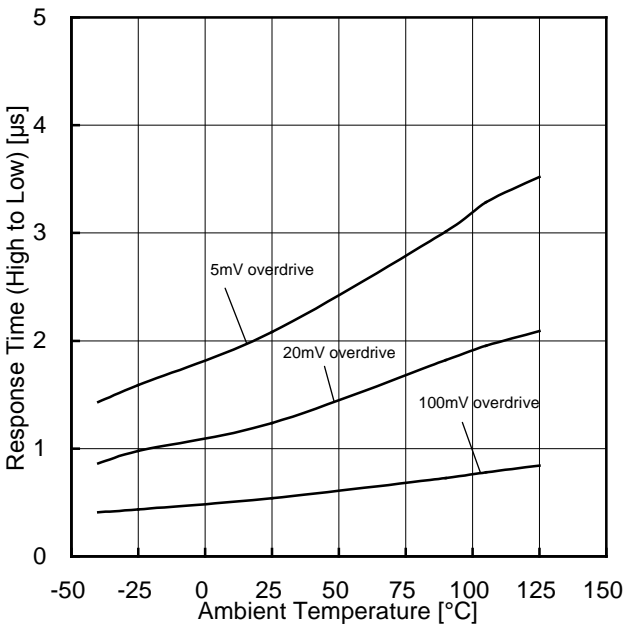

Figure 87.
Response Time (High to Low)
vs Ambient Temperature
(VCC=5V, V_{RL}=5V, R_L=5.1kΩ)

(*)The above characteristics are measurements of typical sample, they are not guaranteed.

BA2903 : -40°C to +125°C BA2903S : -40°C to +105°C BA2903W : -40°C to +125°C

Typical Performance Curves - continued

OBA2901xx, BA2901Sxx

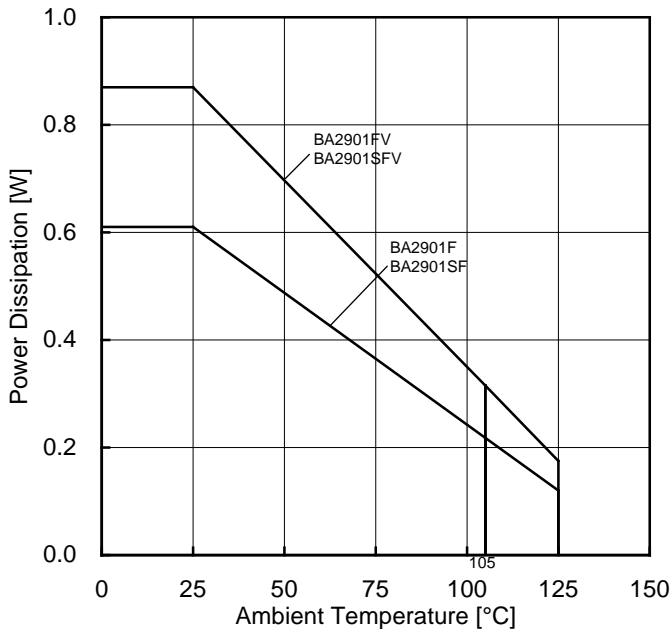

Figure 88.
Power Dissipation vs Ambient Temperature
(Derating Curve)
(Refer to the following operating temperature)

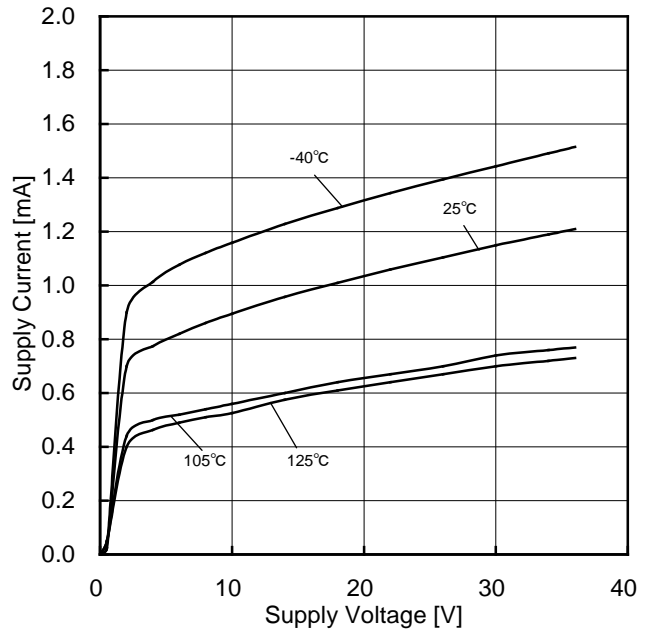

Figure 89.
Supply Current vs Supply Voltage

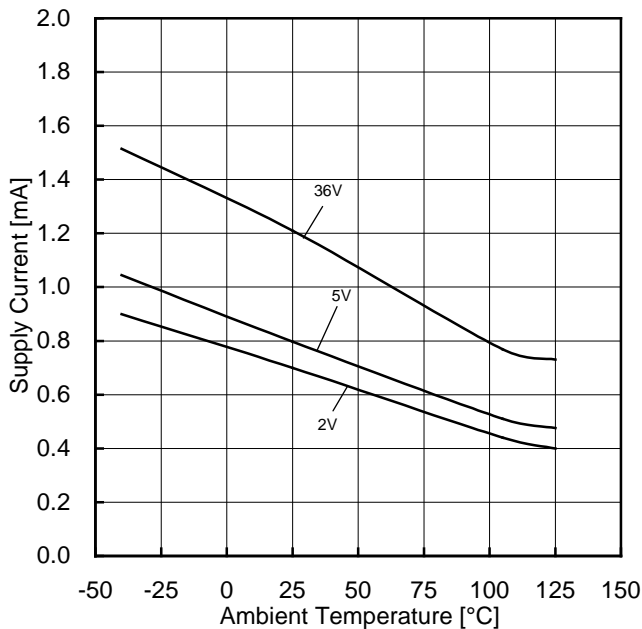

Figure 90.
Supply Current vs Ambient Temperature

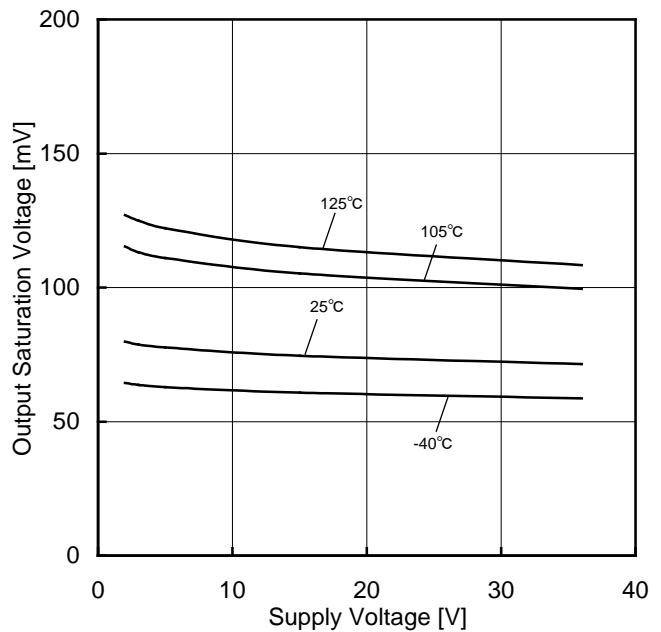

Figure 91.
Output Saturation Voltage vs Supply Voltage
($I_{OL}=4mA$)

(*)The above characteristics are measurements of typical sample, they are not guaranteed.
BA2901 : -40°C to +125°C BA2901S : -40°C to +105°C

Typical Performance Curves - continued

OBA2901xx, BA2901Sxx

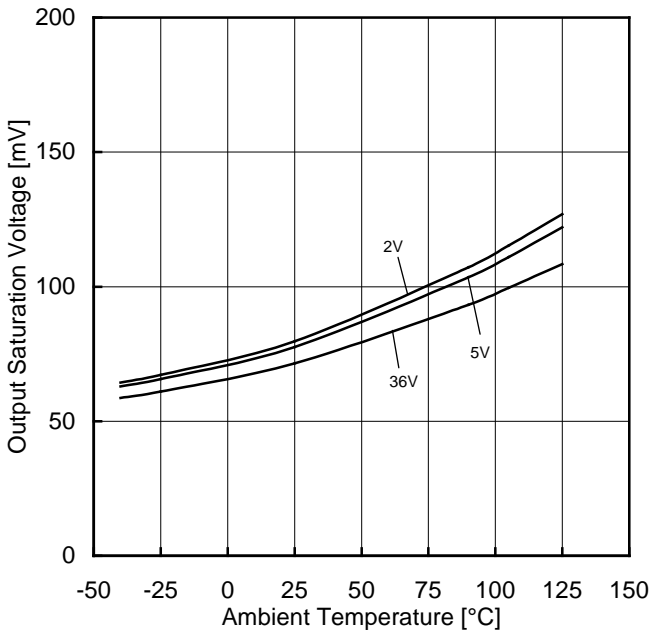

Figure 92.
Output Saturation Voltage vs Ambient Temperature
($I_{OL}=4mA$)

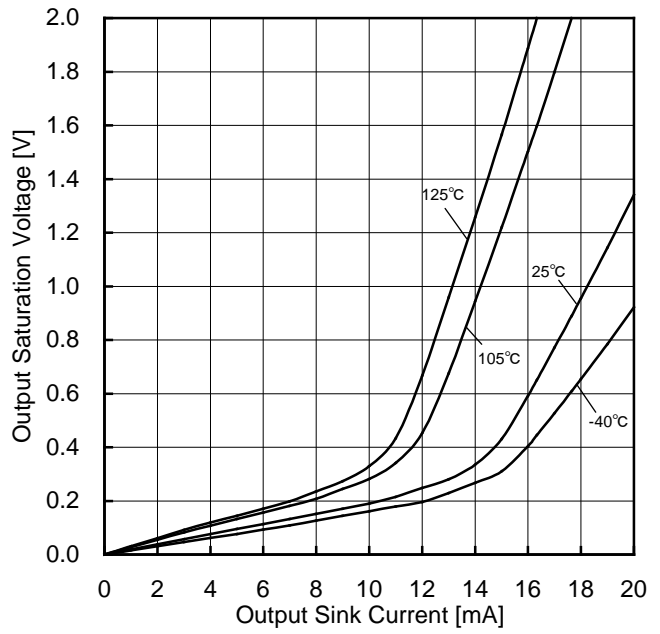

Figure 93.
Output Saturation Voltage vs
Output Sink Current
($V_{CC}=5V$)

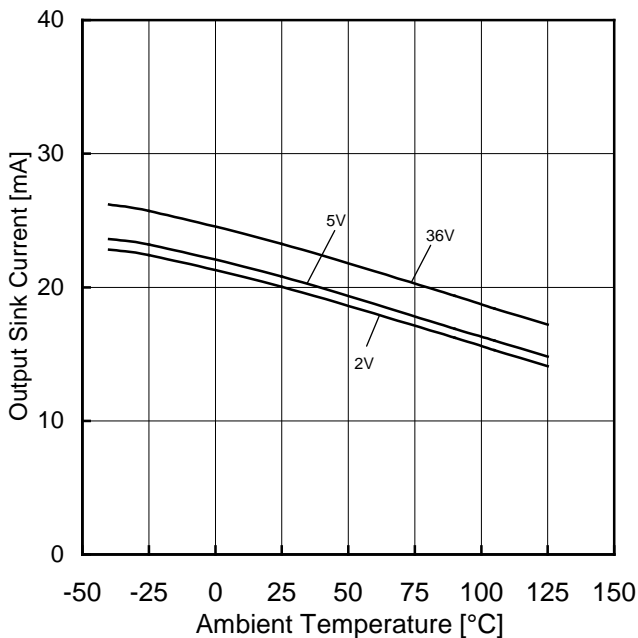

Figure 94.
Output Sink Current vs Ambient Temperature
($OUT=1.5V$)

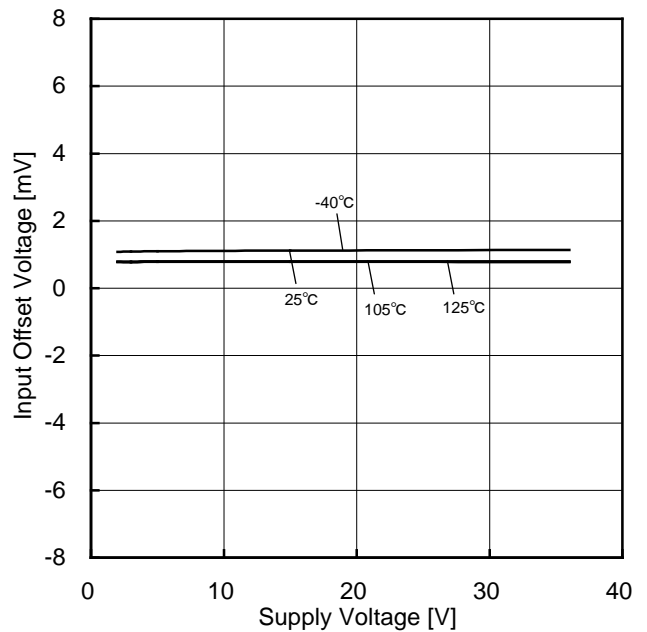

Figure 95.
Input Offset Voltage vs Supply Voltage

(*)The above characteristics are measurements of typical sample, they are not guaranteed.
BA2901 : -40°C to +125°C BA2901S : -40°C to +105°C

Typical Performance Curves - continued

OBA2901xx, BA2901Sxx

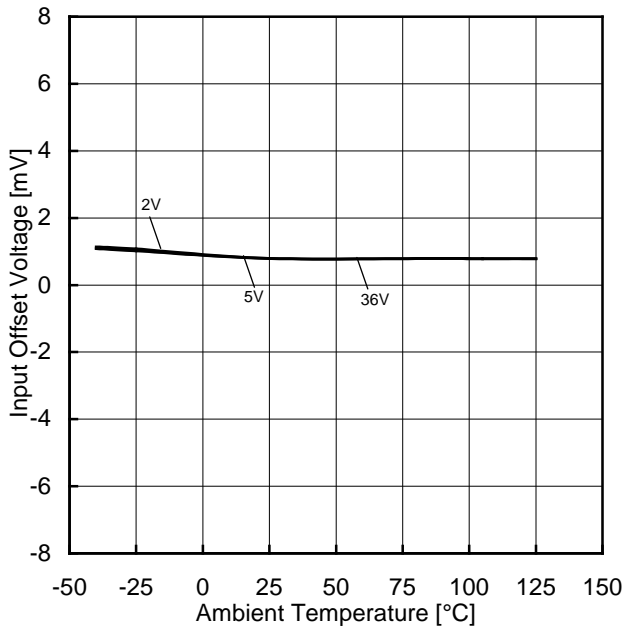

Figure 96.
Input Offset Voltage vs Ambient Temperature

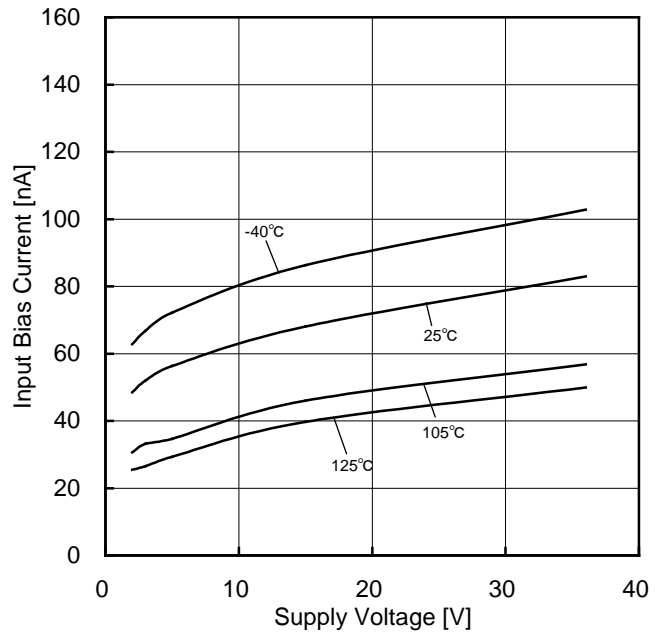

Figure 97.
Input Bias Current vs Supply Voltage

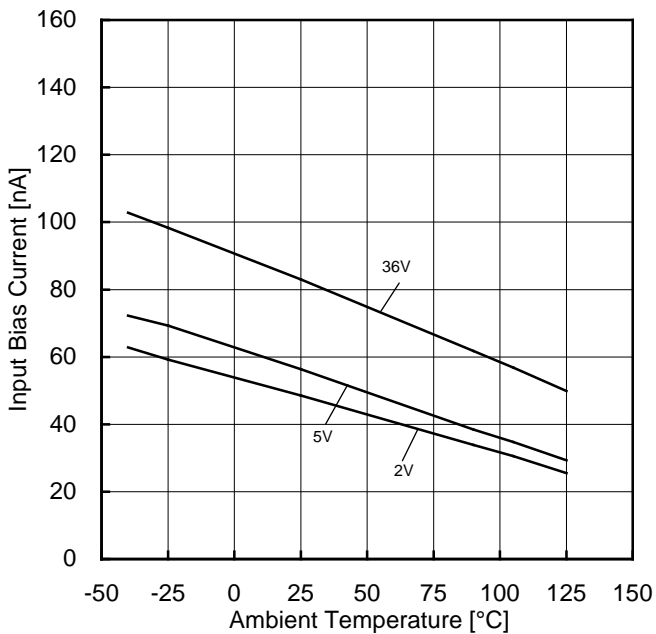

Figure 98.
Input Bias Current vs Ambient Temperature

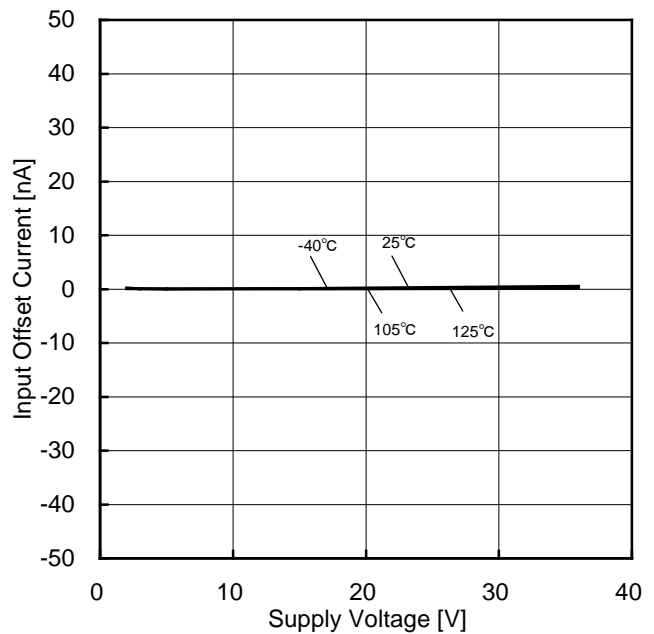

Figure 99.
Input Offset Current vs Supply Voltage

(*)The above characteristics are measurements of typical sample, they are not guaranteed.

BA2901 : -40°C to +125°C BA2901S : -40°C to +105°C

Typical Performance Curves - continued

OBA2901xx, BA2901Sxx

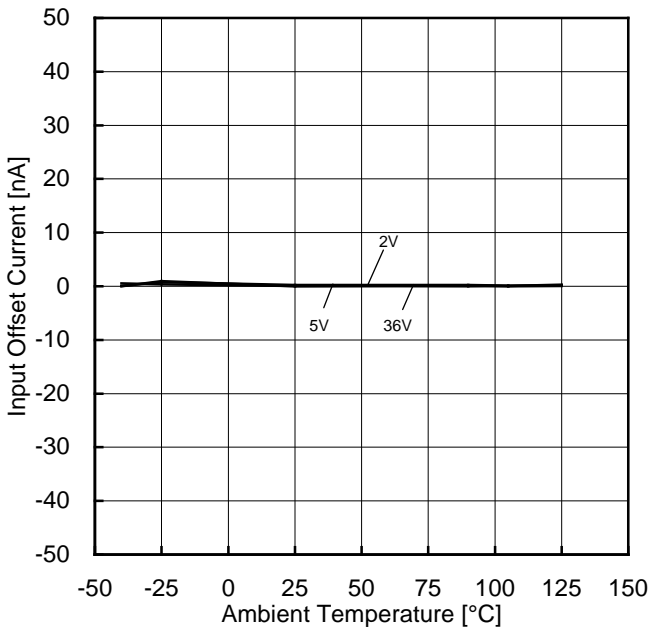

Figure 100.
Input Offset Current vs Ambient Temperature

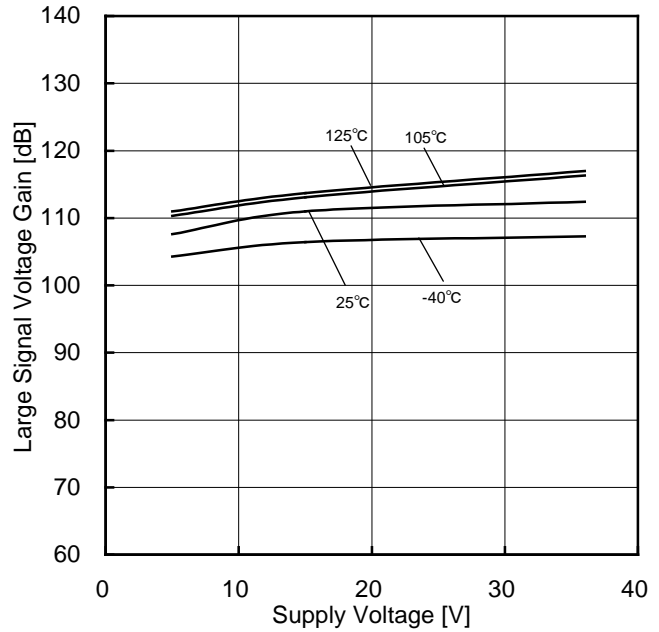

Figure 101.
Large Signal Voltage Gain vs Supply Voltage

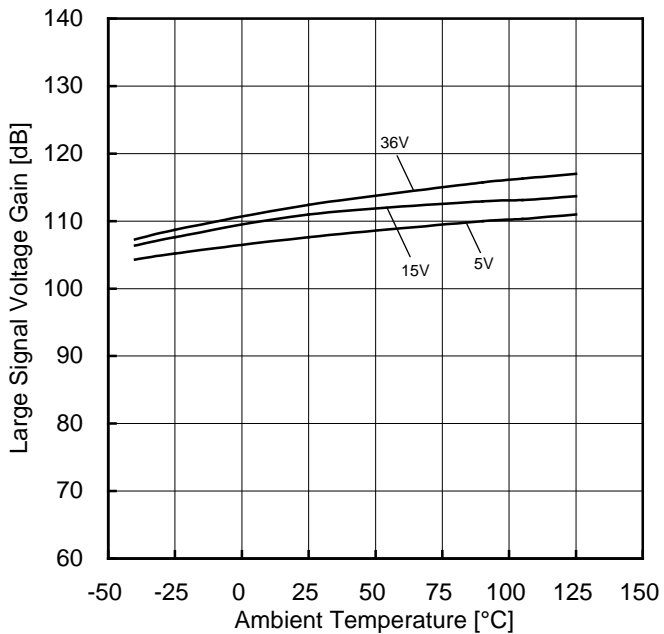

Figure 102.
Large Signal Voltage Gain vs Ambient Temperature

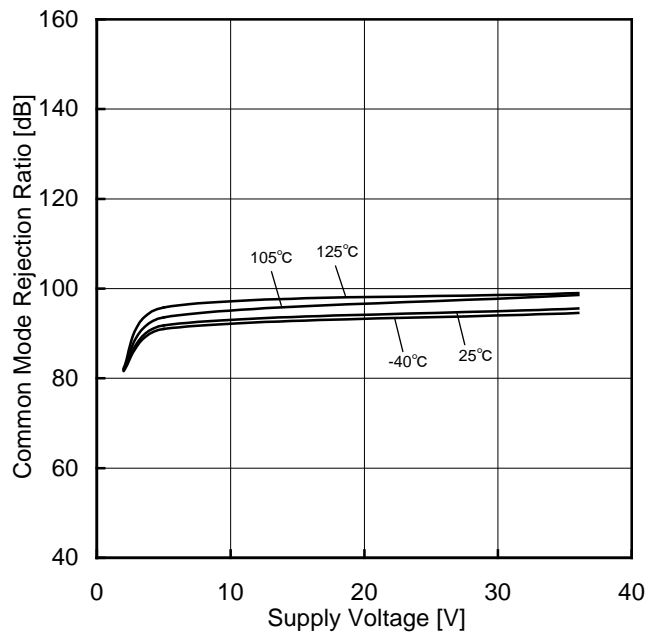

Figure 103.
Common Mode Rejection Ratio vs Supply Voltage

(*)The above characteristics are measurements of typical sample, they are not guaranteed.
BA2901 : -40°C to +125°C BA2901S : -40°C to +105°C

Typical Performance Curves - continued

OBA2901xx, BA2901Sxx

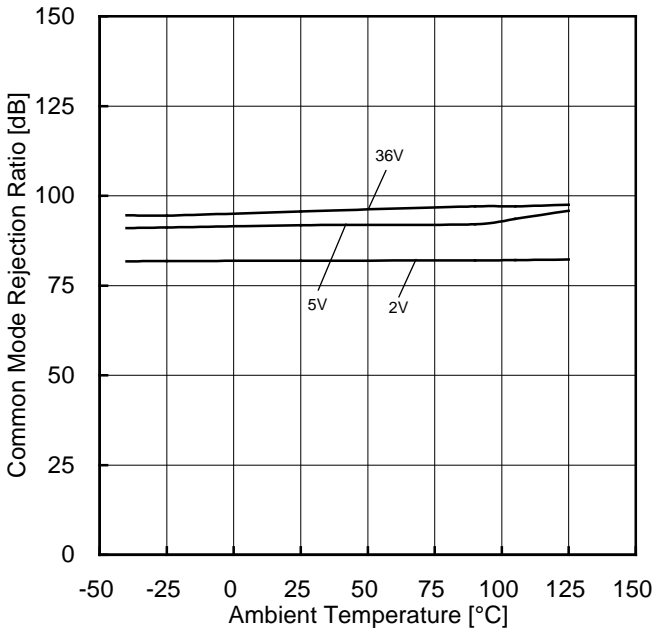

Figure 104.
Common Mode Rejection Ratio vs Ambient Temperature

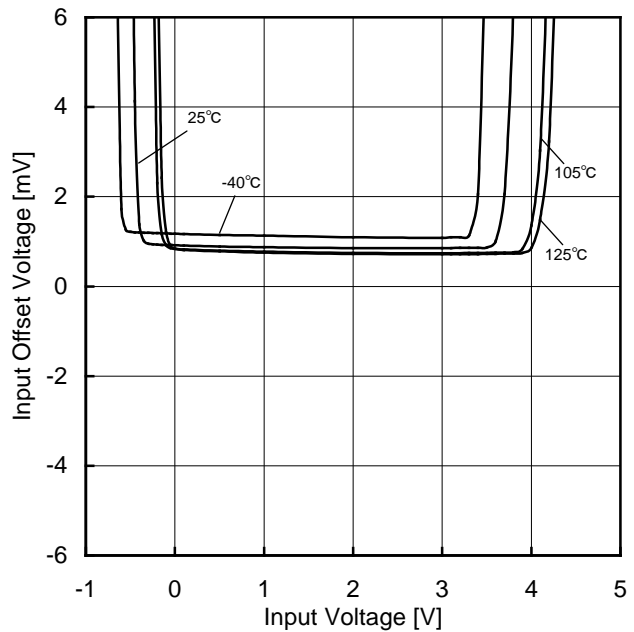

Figure 105.
Input Offset Voltage - Input Voltage (VCC=5V)

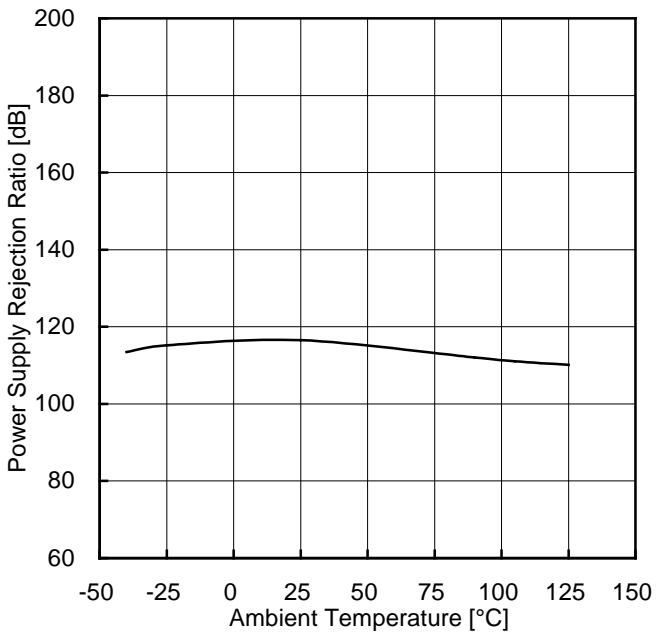

Figure 106.
Power Supply Rejection Ratio vs Ambient Temperature

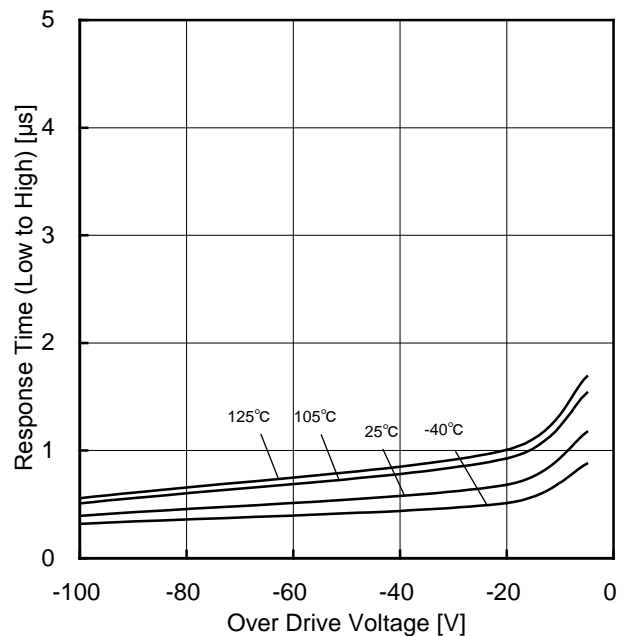

Figure 107.
Response Time (Low to High) vs Over Drive Voltage (VCC=5V, V_{RL}=5V, R_L=5.1kΩ)

(*)The above characteristics are measurements of typical sample, they are not guaranteed.
BA2901 : -40°C to +125°C BA2901S : -40°C to +105°C

Typical Performance Curves - continued

OBA2901xx, BA2901Sxx

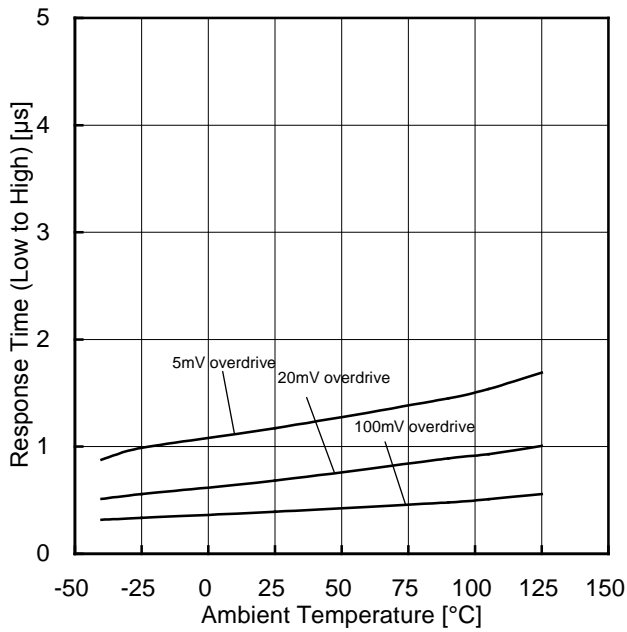

Figure 108.
Response Time (Low to High)
vs Ambient Temperature
(VCC=5V, V_{RL}=5V, R_L=5.1kΩ)

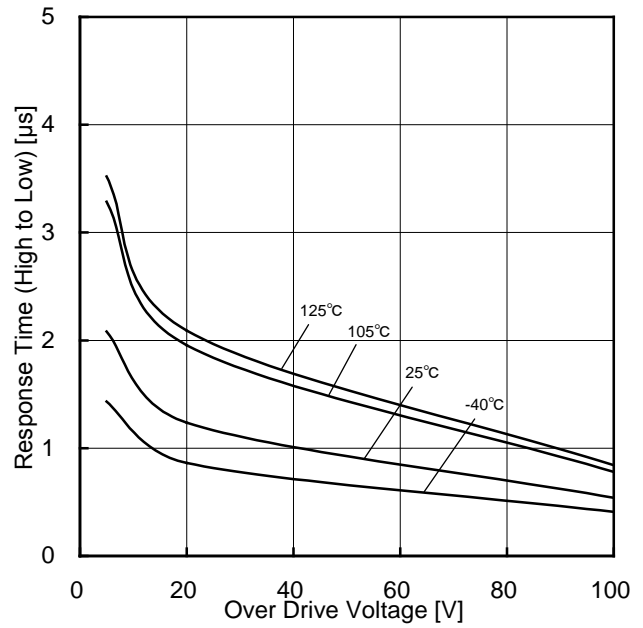

Figure 109.
Response Time (High to Low)
vs Over Drive Voltage
(VCC=5V, V_{RL}=5V, R_L=5.1kΩ)

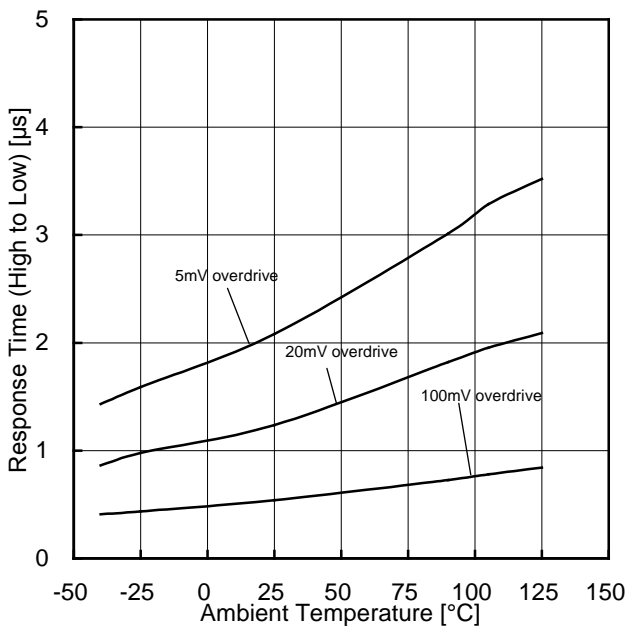

Figure 110.
Response Time (High to Low)
vs Ambient Temperature
(VCC=5V, V_{RL}=5V, R_L=5.1kΩ)

(*)The above characteristics are measurements of typical sample, they are not guaranteed.
BA2901 : -40°C to +125°C BA2901S : -40°C to +105°C

Application Information

NULL method condition for Test Circuit1

VCC, VEE, EK, V_{ICM} Unit : V, V_{RL}=VCC

Parameter	V _F	S1	S2	S3	BA10393 / BA10339				BA8391 / BA2903 / BA2901				Calculation
					VCC	VEE	EK	V _{ICM}	VCC	VEE	EK	V _{ICM}	
Input Offset Voltage	V _{F1}	ON	ON	ON	5	0	-1.4	0	5 to 36	0	-1.4	0	1
Input Offset Current	V _{F2}	OFF	OFF	ON	5	0	-1.4	0	5	0	-1.4	0	2
Input Bias Current	V _{F3}	OFF	ON	ON	5	0	-1.4	0	5	0	-1.4	0	3
	V _{F4}	ON	OFF		5	0	-1.4	0	5	0	-1.4	0	
Large Signal Voltage Gain	V _{F5}	ON	ON	ON	15	0	-1.4	0	15	0	-1.4	0	4
	V _{F6}				15	0	-11.4	0	15	0	-11.4	0	

- Calculation -

1. Input Offset Voltage (V_{IO})

$$V_{IO} = \frac{|V_{F1}|}{1+R_F/R_S} \text{ [V]}$$

2. Input Offset Current (I_{IO})

$$I_{IO} = \frac{|V_{F2}-V_{F1}|}{R_i \times (1+R_F/R_S)} \text{ [A]}$$

3. Input Bias Current (I_B)

$$I_B = \frac{|V_{F4}-V_{F3}|}{2 \times R_i \times (1+R_F/R_S)} \text{ [A]}$$

4. Large Signal Voltage Gain (A_V)

$$A_V = 20\text{Log} \frac{\Delta E_K \times (1+R_F/R_S)}{|V_{F5}-V_{F6}|} \text{ [dB]}$$

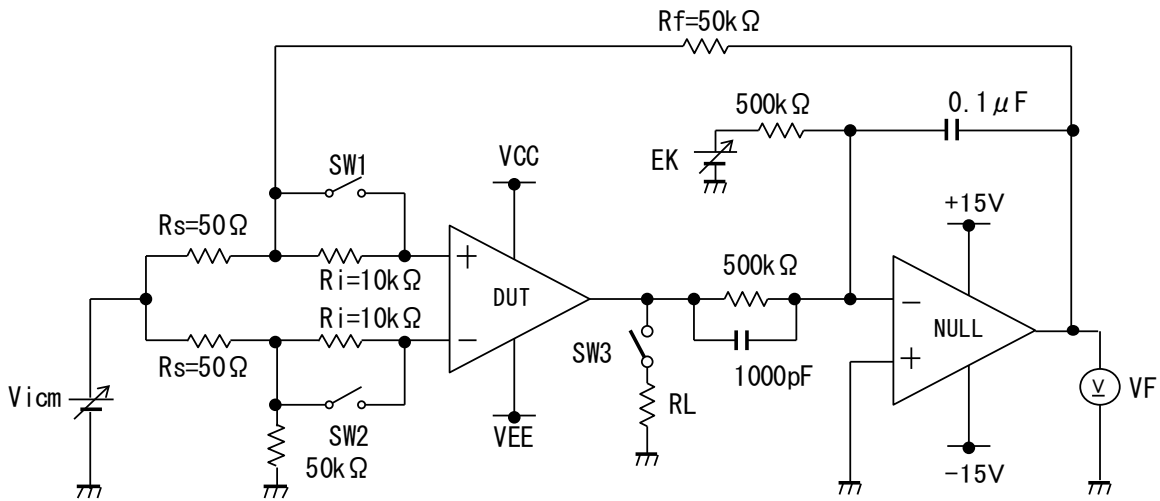

Figure 111. Test Circuit1 (One Channel Only)

Application Information - continued
Switch Condition for Test Circuit 2

SW No.		SW 1	SW 2	SW 3	SW 4	SW 5	SW 6	SW 7
Supply Current		OFF	OFF	OFF	OFF	OFF	OFF	OFF
Output Sink Current	VOL=1.5V	OFF	ON	ON	OFF	OFF	OFF	ON
Saturation Voltage	IOL=4mA	OFF	ON	ON	OFF	ON	ON	OFF
Output Leakage Current	VOH=36V	OFF	ON	ON	OFF	OFF	OFF	ON
Response Time	RL=5.1kΩ, VRL=5V	ON	OFF	ON	ON	OFF	OFF	OFF

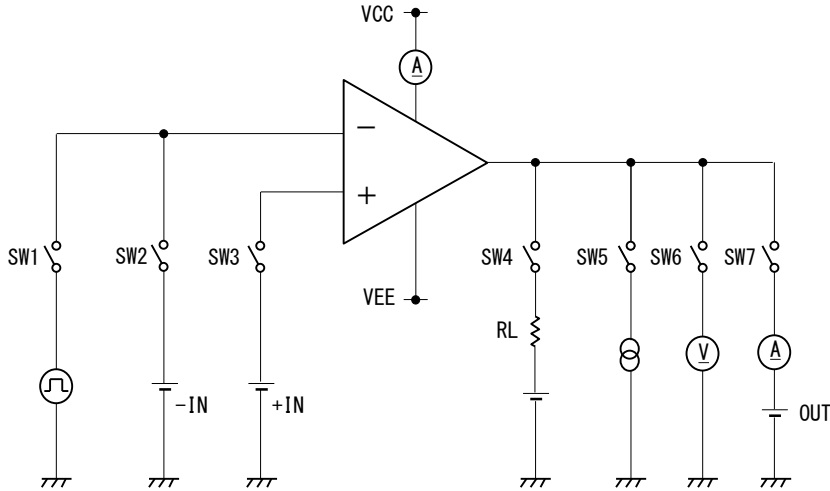

Figure 112. Test Circuit 2 (One Channel Only)

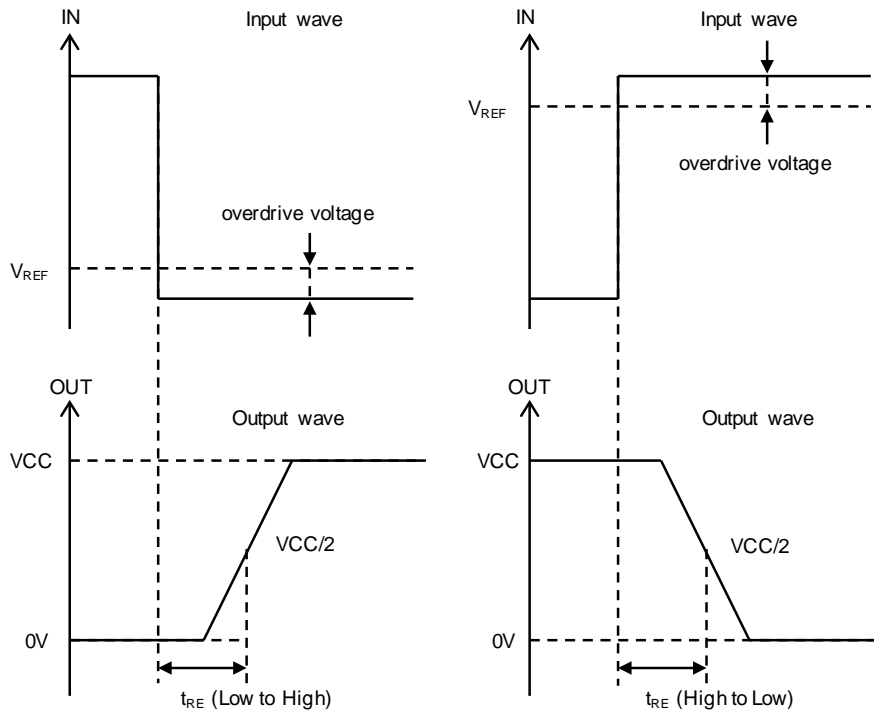

Figure 113. Response Time

Power Dissipation

Power dissipation (total loss) indicates the power that can be consumed by IC at $T_A=25^{\circ}\text{C}$ (normal temperature). IC is heated when it consumed power, and the temperature of IC chip becomes higher than ambient temperature. The temperature that can be accepted by IC chip depends on circuit configuration, manufacturing process, and consumable power is limited. Power dissipation is determined by the temperature allowed in IC chip (maximum junction temperature) and thermal resistance of package (heat dissipation capability). The maximum junction temperature is typically equal to the maximum value in the storage temperature range. Heat generated by consumed power of IC radiates from the mold resin or lead frame of the package. The parameter which indicates this heat dissipation capability (hardness of heat release) is called thermal resistance, represented by the symbol θ_{ja} $^{\circ}\text{C}/\text{W}$. The temperature of IC inside the package can be estimated by this thermal resistance. Figure 114 (a) shows the model of thermal resistance of the package. Thermal resistance θ_{ja} , ambient temperature T_A , maximum junction temperature T_{jmax} , and power dissipation P_D can be calculated by the equation below:

$$\theta_{ja} = (T_{jmax} - T_A) / P_D \quad ^{\circ}\text{C}/\text{W} \quad \dots \dots \dots (I)$$

Derating curve in Figure 114 (b) indicates power that can be consumed by IC with reference to ambient temperature. Power that can be consumed by IC begins to attenuate at certain ambient temperature. This gradient is determined by thermal resistance θ_{ja} . Thermal resistance θ_{ja} depends on chip size, power consumption, package, ambient temperature, package condition, wind velocity, etc even when the same of package is used. Thermal reduction curve indicates a reference value measured at a specified condition. Figure 115 (c) to (g) shows a derating curve for an example of BA8391, BA10393, BA10339, BA2903S, BA2903, BA2903W, BA2901S, and BA2901.

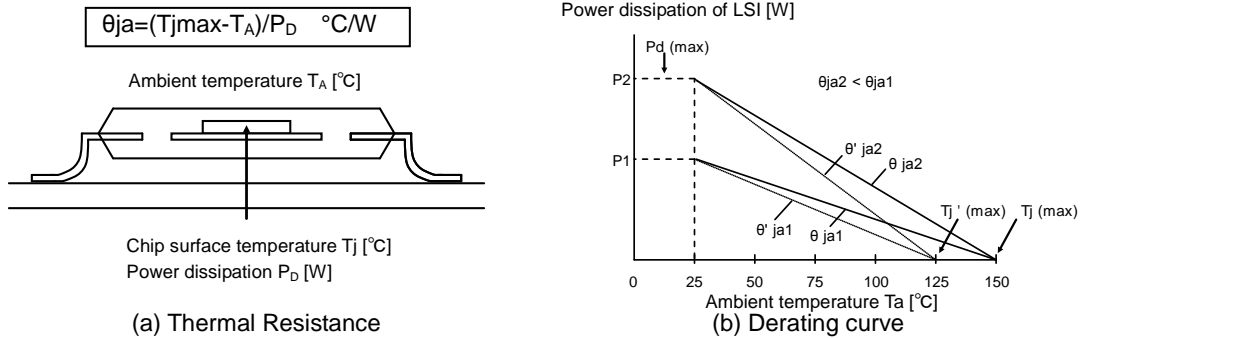
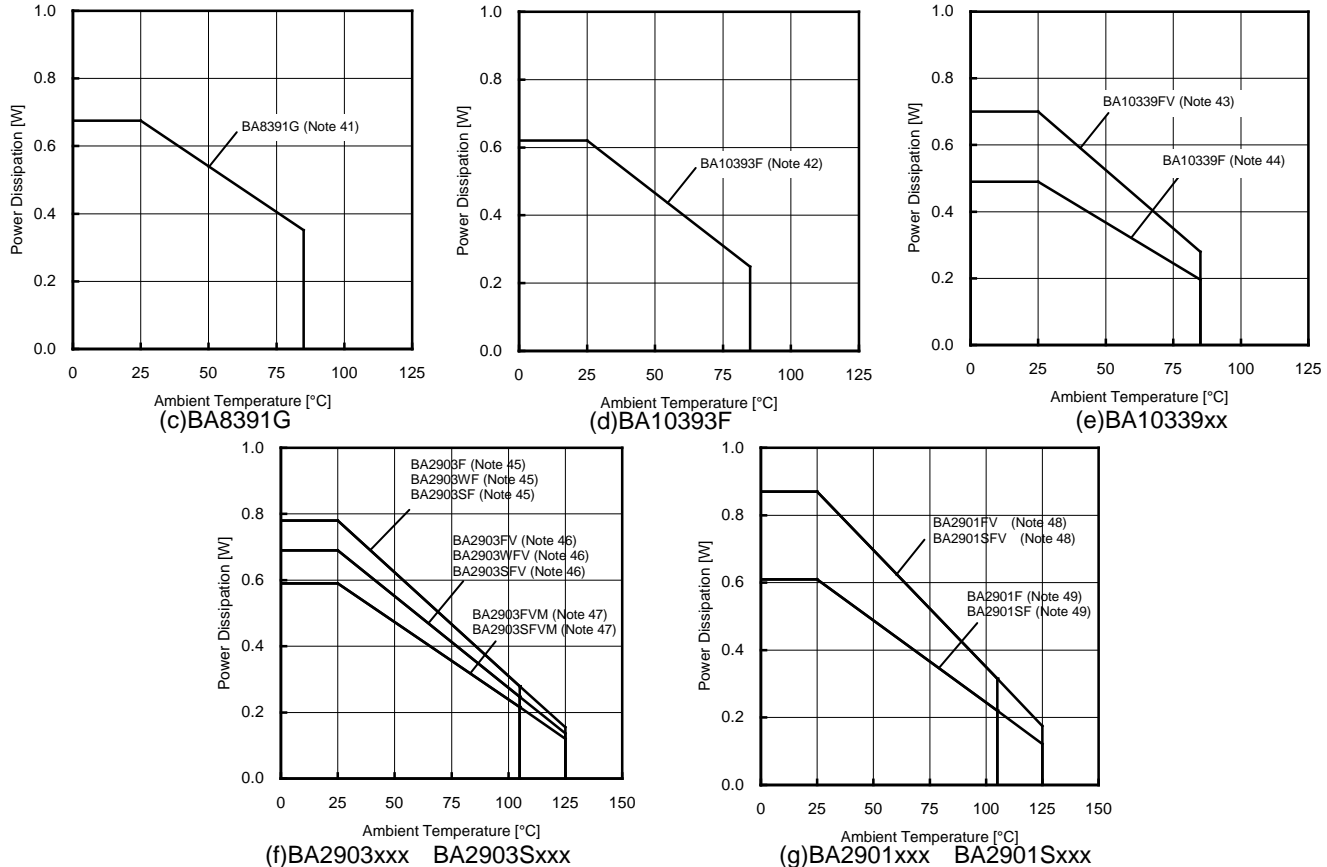

Figure 114. Thermal Resistance and Derating Curve



(Note 41)	(Note 42)	(Note 43)	(Note 44)	(Note 45)	(Note 46)	(Note 47)	(Note 48)	(Note 49)	Unit
5.4	6.2	7.0	4.9	6.2	5.5	4.7	7.0	4.9	mW/°C

When using the unit above $T_a=25^{\circ}\text{C}$, subtract the value above per degree $^{\circ}\text{C}$.
Permissible dissipation is the value when FR4 glass epoxy board 70mm x 70mm x 1.6mm (cooper foil area below 3%) is mounted.

Figure 115. Derating Curve

Example of Circuit

○Reference voltage is V_{IN-} .

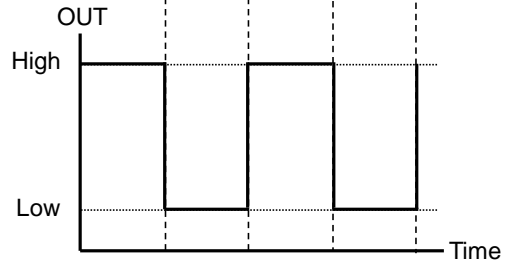
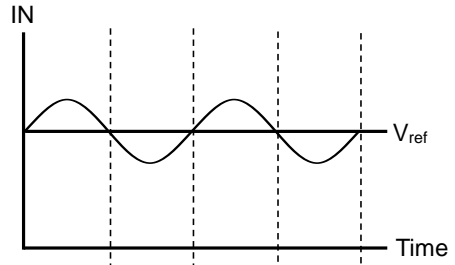
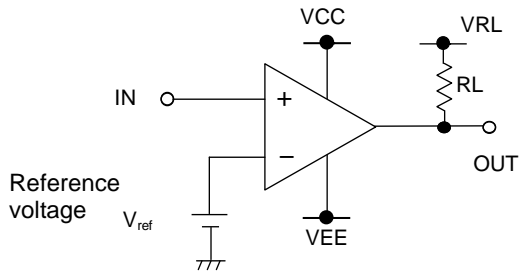

While input voltage is bigger than reference voltage, output voltage is high. While input voltage is smaller than reference voltage, output voltage is low.

○Reference voltage is V_{IN+} .

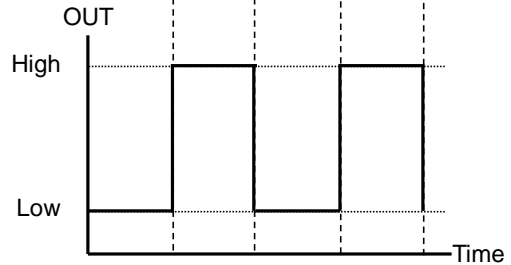
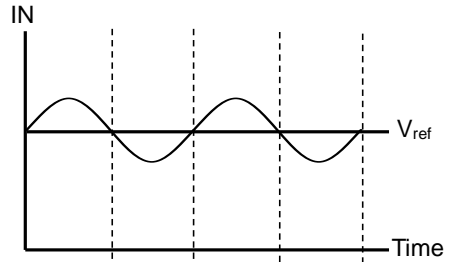
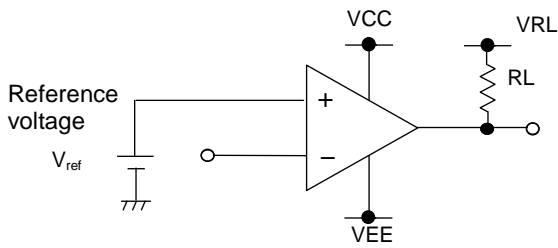

While input voltage is smaller than reference voltage, output voltage is high. While input voltage is bigger than reference voltage, output voltage is low.

Operational Notes**1. Reverse Connection of Power Supply**

Connecting the power supply in reverse polarity can damage the IC. Take precautions against reverse polarity when connecting the power supply, such as mounting an external diode between the power supply and the IC's power supply terminals.

2. Power Supply Lines

Design the PCB layout pattern to provide low impedance ground and supply lines. Separate the ground and supply lines of the digital and analog blocks to prevent noise in the ground and supply lines of the digital block from affecting the analog block. Furthermore, connect a capacitor to ground at all power supply pins. Consider the effect of temperature and aging on the capacitance value when using electrolytic capacitors.

3. Ground Voltage

Ensure that no pins are at a voltage below that of the ground pin at any time, even during transient condition.

4. Ground Wiring Pattern

When using both small-signal and large-current ground traces, the two ground traces should be routed separately but connected to a single ground at the reference point of the application board to avoid fluctuations in the small-signal ground caused by large currents. Also ensure that the ground traces of external components do not cause variations on the ground voltage. The ground lines must be as short and thick as possible to reduce line impedance.

5. Thermal Consideration

Should by any chance the power dissipation rating be exceeded, the rise in temperature of the chip may result in deterioration of the properties of the chip. In case of exceeding this absolute maximum rating, increase the board size and copper area to prevent exceeding the Pd rating.

6. Recommended Operating Conditions

These conditions represent a range within which the expected characteristics of the IC can be approximately obtained. The electrical characteristics are guaranteed under the conditions of each parameter.

7. Inrush Current

When power is first supplied to the IC, it is possible that the internal logic may be unstable and inrush current may flow instantaneously due to the internal powering sequence and delays, especially if the IC has more than one power supply. Therefore, give special consideration to power coupling capacitance, power wiring, width of ground wiring, and routing of connections.

8. Operation Under Strong Electromagnetic Field

Operating the IC in the presence of a strong electromagnetic field may cause the IC to malfunction.

9. Testing on Application Boards

When testing the IC on an application board, connecting a capacitor directly to a low-impedance output pin may subject the IC to stress. Always discharge capacitors completely after each process or step. The IC's power supply should always be turned off completely before connecting or removing it from the test setup during the inspection process. To prevent damage from static discharge, ground the IC during assembly and use similar precautions during transport and storage.

10. Inter-pin Short and Mounting Errors

Ensure that the direction and position are correct when mounting the IC on the PCB. Incorrect mounting may result in damaging the IC. Avoid nearby pins being shorted to each other especially to ground. Inter-pin shorts could be due to many reasons such as metal particles, water droplets (in very humid environment) and unintentional solder bridge deposited in between pins during assembly to name a few.

Operational Notes – continued

11. Regarding Input Pins of the IC

This monolithic IC contains P+ isolation and P substrate layers between adjacent elements in order to keep them isolated. P-N junctions are formed at the intersection of the P layers with the N layers of other elements, creating a parasitic diode or transistor. For example (refer to figure below):

When $GND > Pin A$ and $GND > Pin B$, the P-N junction operates as a parasitic diode.

When $GND > Pin B$, the P-N junction operates as a parasitic transistor.

Parasitic diodes inevitably occur in the structure of the IC. The operation of parasitic diodes can result in mutual interference among circuits, operational faults, or physical damage. Therefore, conditions that cause these diodes to operate, such as applying a voltage lower than the GND voltage to an input pin (and thus to the P substrate) should be avoided.

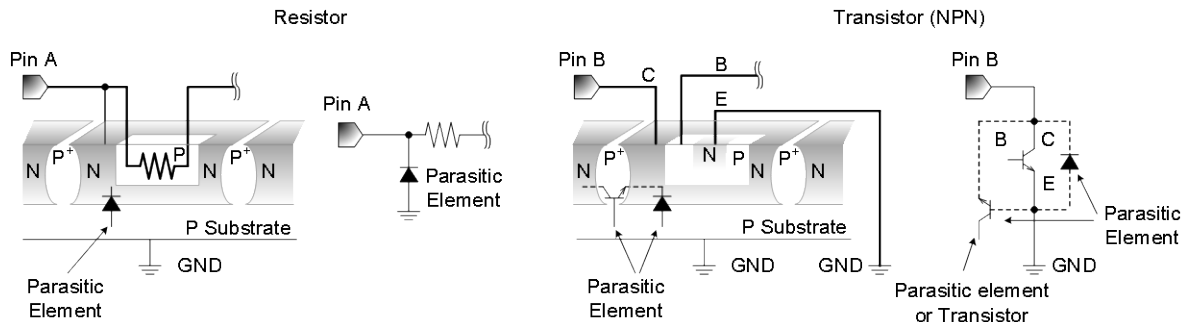

Figure 116. Example of Monolithic IC Structure

12. Unused Circuits

When there are unused circuits it is recommended that they be connected as in Figure 117, setting the non-inverting input terminal to a potential within the in-phase input voltage range (V_{ICM}).

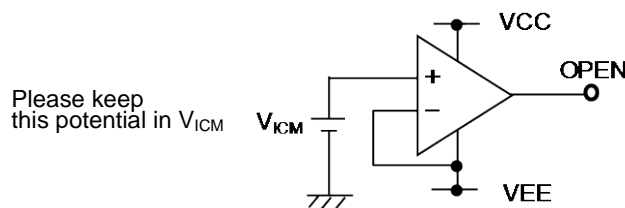

Figure 117. Disable Circuit Example

13. Ceramic Capacitor

When using a ceramic capacitor, determine the dielectric constant considering the change of capacitance with temperature and the decrease in nominal capacitance due to DC bias and others.

14. Input Terminal Voltage

(BA8391G / BA2903xxxx / BA2901xxx) Applying $VEE + 36V$ to the input terminal is possible without causing deterioration of the electrical characteristics or destruction, irrespective of the supply voltage. However, this does not ensure normal circuit operation. Please note that the circuit operates normally only when the input voltage is within the common mode input voltage range of the electric characteristics.

15. Power Supply (single / split)

The comparators when the specified voltage supplied is between VCC and VEE. Therefore, the single supply comparators can be used as a dual supply comparators as well.

16. Terminal short-circuits

When the output and VCC terminals are shorted, excessive output current may flow, resulting in undue heat generation and, subsequently, destruction.

17. IC Handling

Applying mechanical stress to the IC by deflecting or bending the board may cause fluctuations in the electrical characteristics due to piezo resistance effects.

Physical Dimension Tape and Reel Information

Package Name	SSOP5
--------------	-------

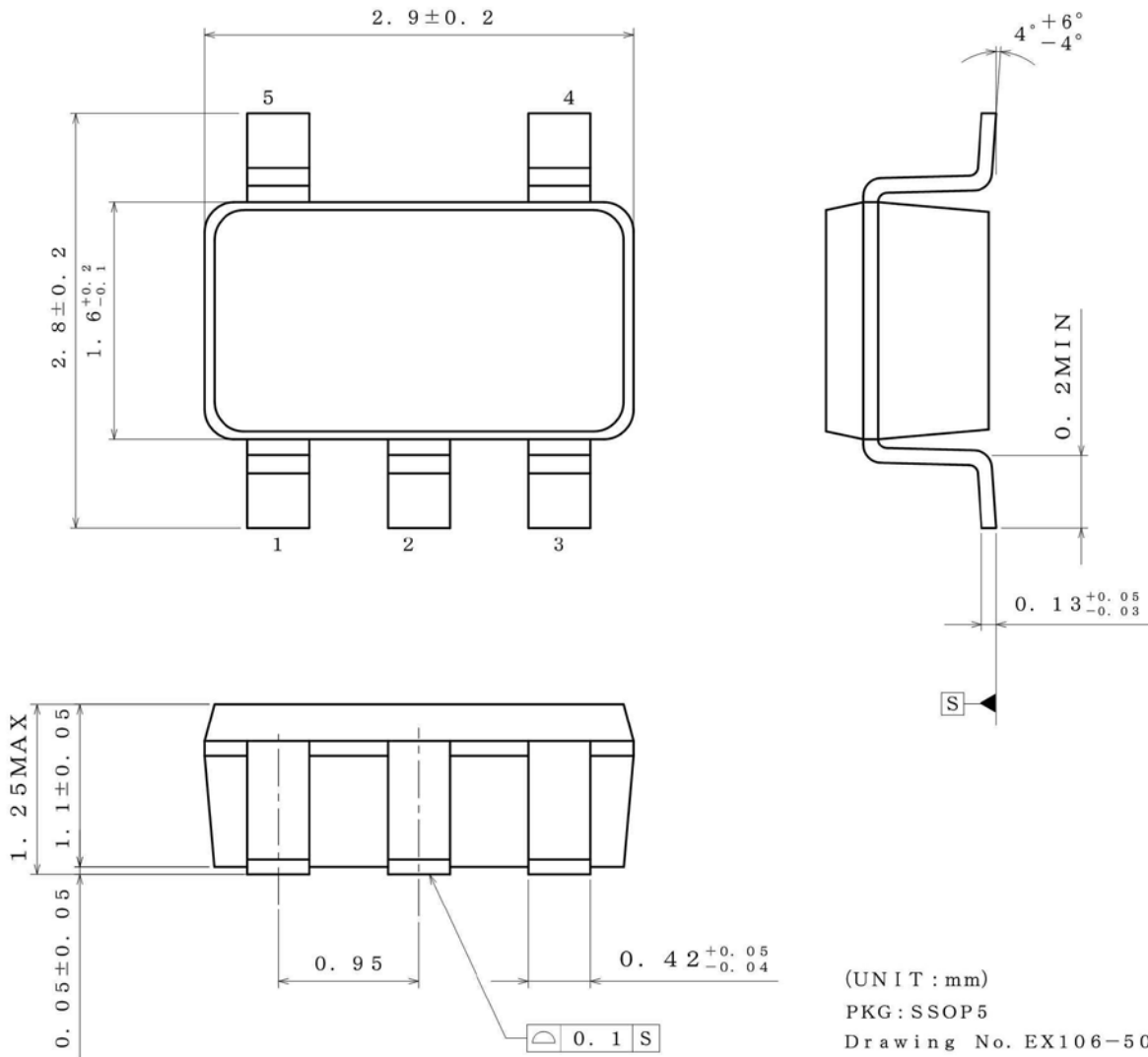

< Tape and Reel Information >

Tape	Embossed carrier tape
Quantity	3000pcs
Direction of feed	TR (The direction is the 1pin of product is at the upper right when you hold) reel on the left hand and you pull out the tape on the right hand)

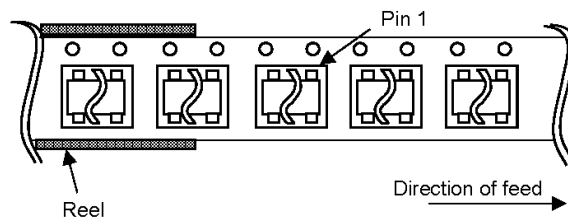

Physical Dimension Tape and Reel Information - continued

Package Name	SOP8
--------------	------

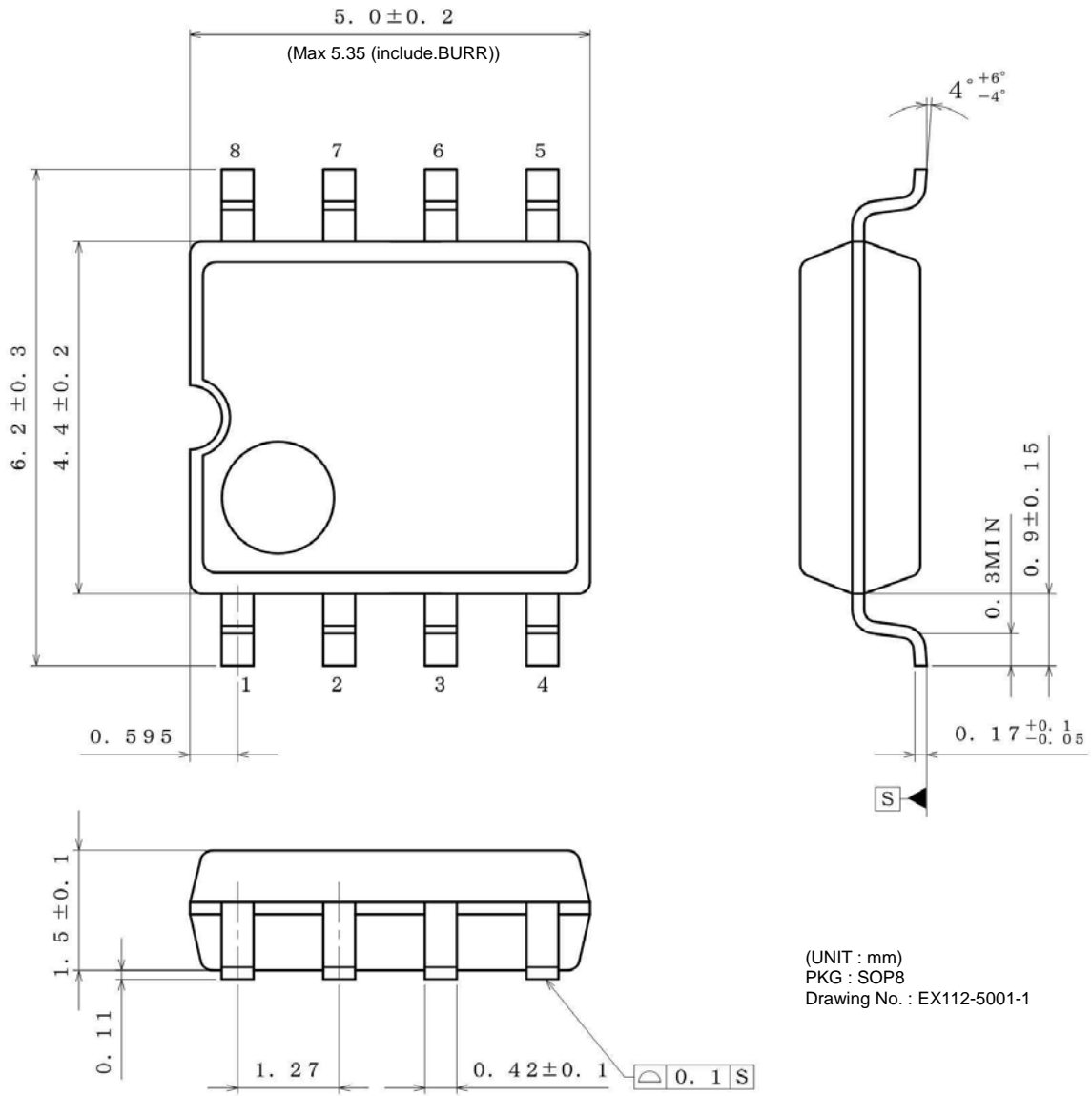

(UNIT : mm)
 PKG : SOP8
 Drawing No. : EX112-5001-1

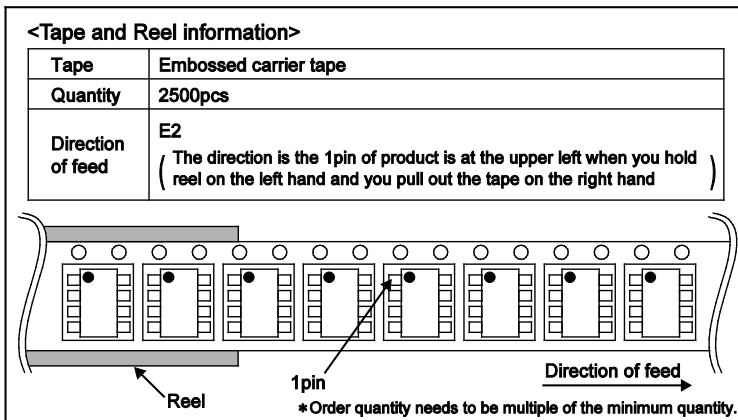

Physical Dimension Tape and Reel Information - continued

Package Name	SSOP-B8
--------------	---------

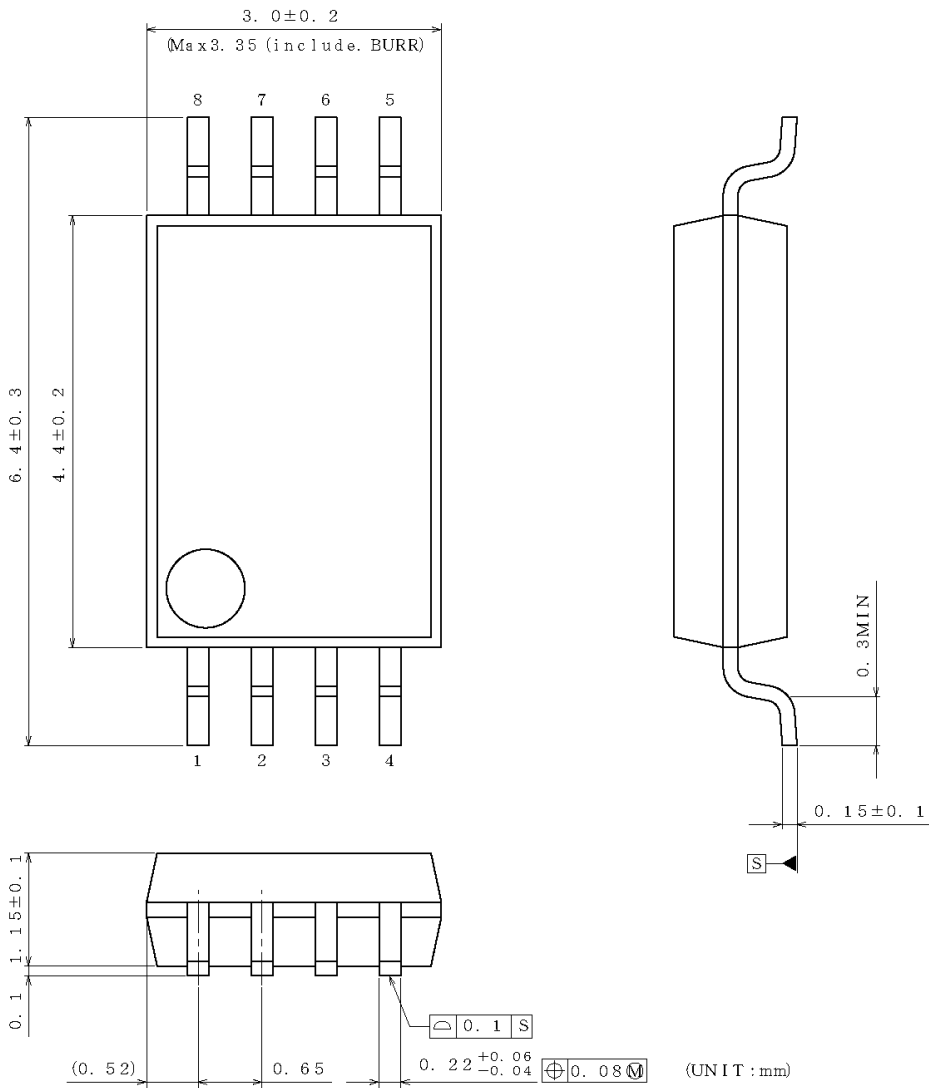

(UNIT : mm)
 PKG : SSOP-B8
 Drawing No. EX151-5002

<Tape and Reel information>

Tape	Embossed carrier tape
Quantity	2500pcs
Direction of feed	E2 (The direction is the 1pin of product is at the upper left when you hold reel on the left hand and you pull out the tape on the right hand)

Diagram of an embossed carrier tape showing the direction of feed and the location of the 1st pin.

- The diagram shows a series of carrier tape pockets, each containing a component.
- An arrow labeled "Reel" points to the left, indicating the direction of the tape.
- An arrow labeled "Direction of feed" points to the right.
- A specific pin is labeled "1pin".
- A note states: "*Order quantity needs to be multiple of the minimum quantity."

Physical Dimension Tape and Reel Information - continued

Package Name	MSOP8
--------------	-------

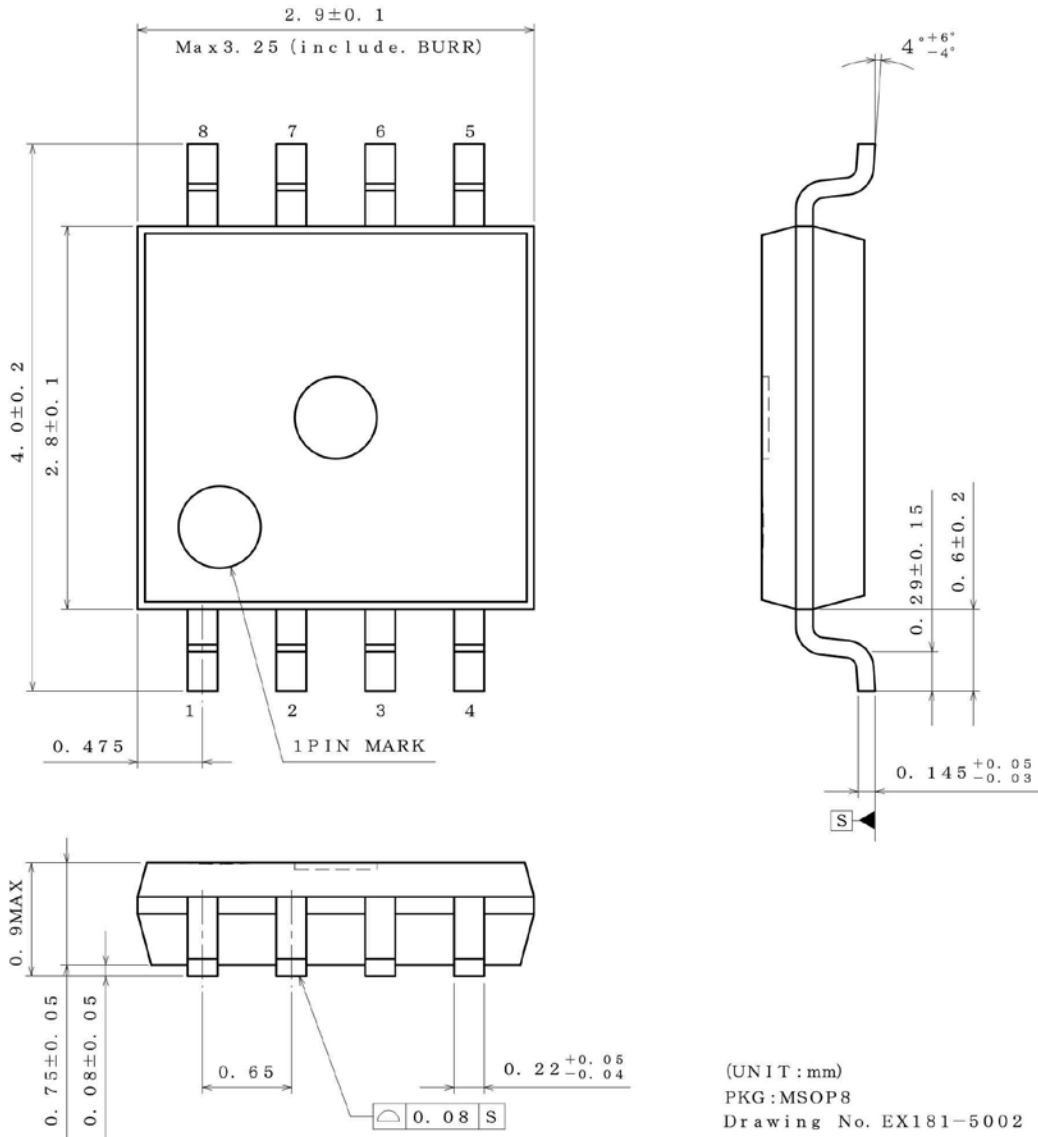

<Tape and Reel information>

Tape	Embossed carrier tape
Quantity	3000pcs
Direction of feed	TR (The direction is the 1pin of product is at the upper right when you hold reel on the left hand and you pull out the tape on the right hand)

* Order quantity needs to be multiple of the minimum quantity.

Physical Dimension Tape and Reel Information - continued

Package Name	SOP14
--------------	-------

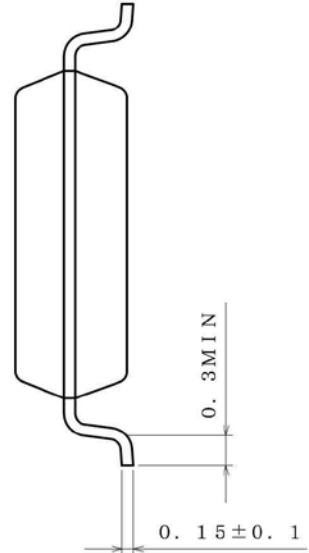
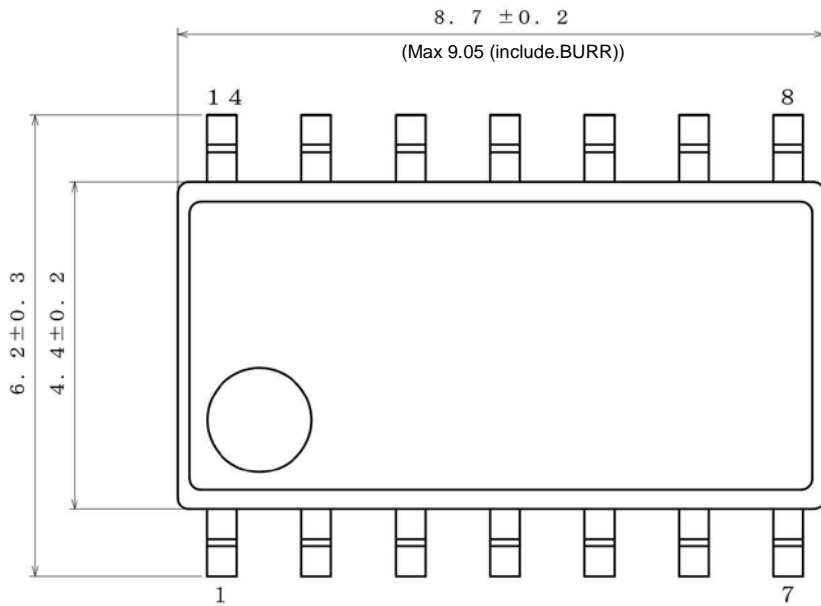

(UNIT : mm)
PKG : SOP14
Drawing No. : EX113-5001

<Tape and Reel information>

Tape	Embossed carrier tape
Quantity	2500pcs
Direction of feed	E2 (The direction is the 1pin of product is at the upper left when you hold reel on the left hand and you pull out the tape on the right hand)

Reel

1pin

Direction of feed

*Order quantity needs to be multiple of the minimum quantity.

Physical Dimension Tape and Reel Information - continued

Package Name	SSOP-B14
--------------	----------

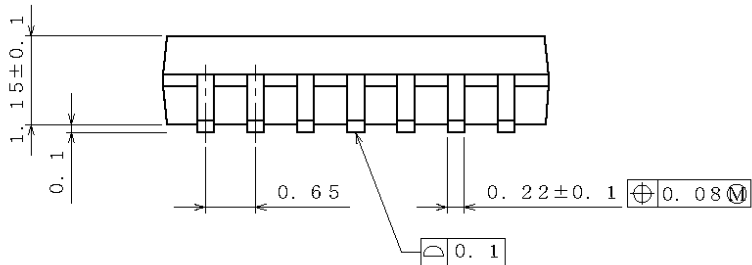
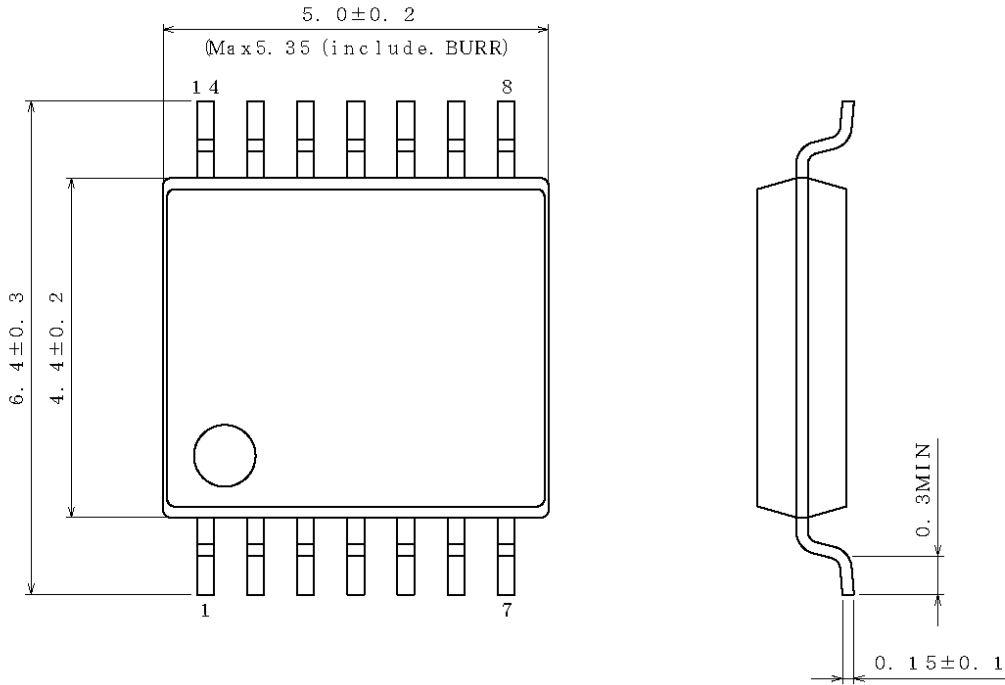

(UNIT : mm)
 PKG : SSOP-B14
 Drawing No. EX152-5002

<Tape and Reel information>

Tape	Embossed carrier tape
Quantity	2500pcs
Direction of feed	E2 (The direction is the 1pin of product is at the upper left when you hold reel on the left hand and you pull out the tape on the right hand)

Marking Diagrams

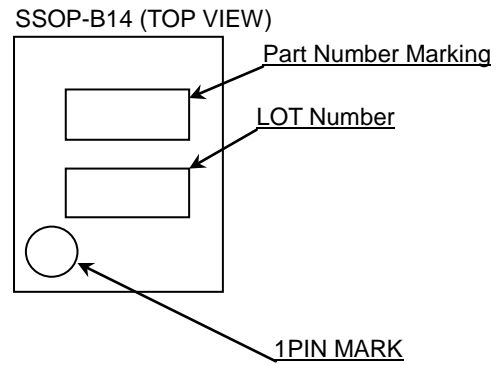
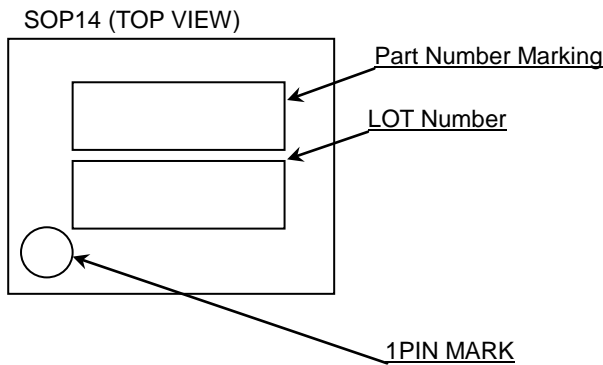
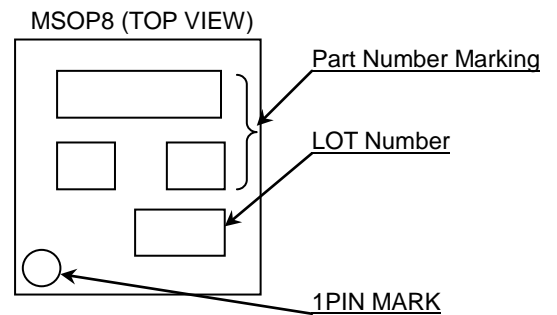
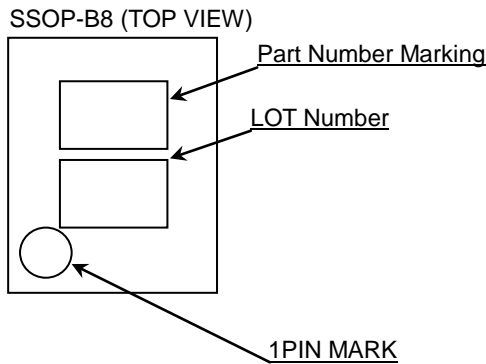
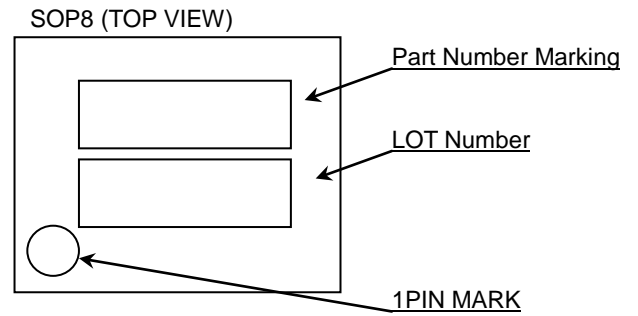
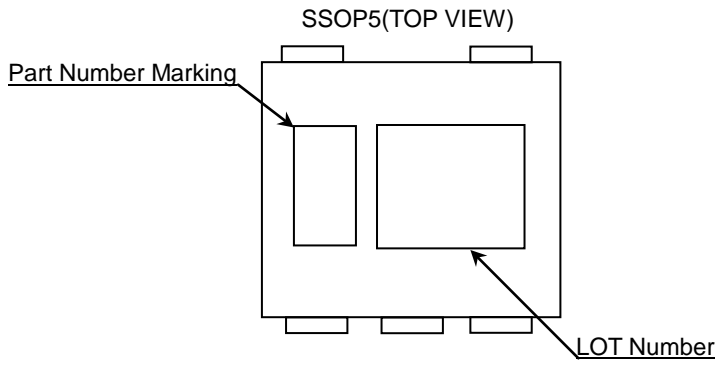

Product Name		Package Type	Marking
BA8391	G	SSOP5	D6
BA10393	F	SOP8	10393
BA10339	F	SOP14	BA10339F
	FV	SSOP-B14	339
BA2903	F	SOP8	2903
	FV	SSOP-B8	
	FVM	MSOP8	
BA2903W	F	SOP8	2903S
	FV	SSOP-B8	
BA2903S	F	SOP8	2903S
	FV	SSOP-B8	03S
	FVM	MSOP8	2903S
BA2901	F	SOP14	BA2901F
	FV	SSOP-B14	2901
BA2901S	F	SOP14	2901S
	FV	SSOP-B14	

Land Pattern Data

All dimensions in mm

PKG	Land Pitch e	Land Space MIE	Land Length $\geq l_2$	Land Width b2
SSOP5	0.95	2.4	1.0	0.6
SOP8 SOP14	1.27	4.60	1.10	0.76
SSOP-B8 SSOP-B14	0.65	4.60	1.20	0.35
MSOP8	0.65	2.62	0.99	0.35

SSOP5

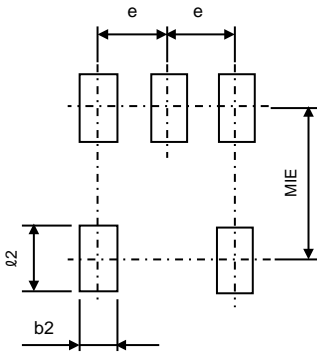

SOP8, SOP14, SSOP-B8
SSOP-B14, MSOP8

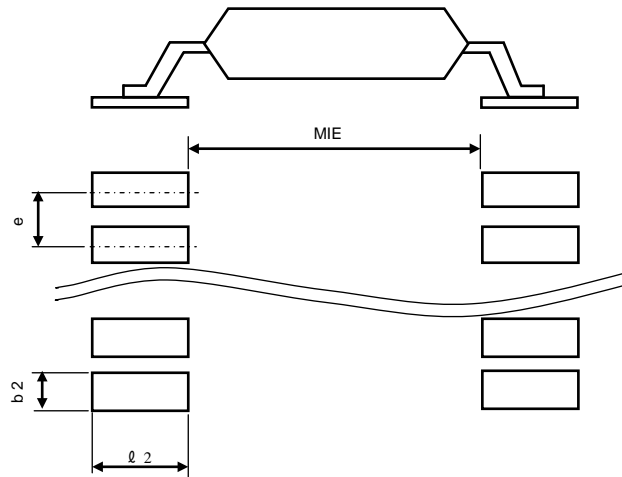

Revision History

Date	Revision	Changes
23.Aug.2013	001	New Release
27.Nov.2013	002	Add the dB notation in Large Signal Voltage Gain
11.Dec.2013	003	Input offset voltage unit is changed from mA to mV in Page.1.
05.Jun.2015	004	Corrections. Update of Operational Notes

Notice

Precaution on using ROHM Products

- Our Products are designed and manufactured for application in ordinary electronic equipments (such as AV equipment, OA equipment, telecommunication equipment, home electronic appliances, amusement equipment, etc.). If you intend to use our Products in devices requiring extremely high reliability (such as medical equipment ^(Note 1), transport equipment, traffic equipment, aircraft/spacecraft, nuclear power controllers, fuel controllers, car equipment including car accessories, safety devices, etc.) and whose malfunction or failure may cause loss of human life, bodily injury or serious damage to property ("Specific Applications"), please consult with the ROHM sales representative in advance. Unless otherwise agreed in writing by ROHM in advance, ROHM shall not be in any way responsible or liable for any damages, expenses or losses incurred by you or third parties arising from the use of any ROHM's Products for Specific Applications.

(Note1) Medical Equipment Classification of the Specific Applications

JAPAN	USA	EU	CHINA
CLASS III	CLASS III	CLASS II b	CLASS III
CLASS IV		CLASS III	

- ROHM designs and manufactures its Products subject to strict quality control system. However, semiconductor products can fail or malfunction at a certain rate. Please be sure to implement, at your own responsibilities, adequate safety measures including but not limited to fail-safe design against the physical injury, damage to any property, which a failure or malfunction of our Products may cause. The following are examples of safety measures:
 - Installation of protection circuits or other protective devices to improve system safety
 - Installation of redundant circuits to reduce the impact of single or multiple circuit failure
- Our Products are designed and manufactured for use under standard conditions and not under any special or extraordinary environments or conditions, as exemplified below. Accordingly, ROHM shall not be in any way responsible or liable for any damages, expenses or losses arising from the use of any ROHM's Products under any special or extraordinary environments or conditions. If you intend to use our Products under any special or extraordinary environments or conditions (as exemplified below), your independent verification and confirmation of product performance, reliability, etc. prior to use, must be necessary:
 - Use of our Products in any types of liquid, including water, oils, chemicals, and organic solvents
 - Use of our Products outdoors or in places where the Products are exposed to direct sunlight or dust
 - Use of our Products in places where the Products are exposed to sea wind or corrosive gases, including Cl₂, H₂S, NH₃, SO₂, and NO₂
 - Use of our Products in places where the Products are exposed to static electricity or electromagnetic waves
 - Use of our Products in proximity to heat-producing components, plastic cords, or other flammable items
 - Sealing or coating our Products with resin or other coating materials
 - Use of our Products without cleaning residue of flux (even if you use no-clean type fluxes, cleaning residue of flux is recommended); or Washing our Products by using water or water-soluble cleaning agents for cleaning residue after soldering
 - Use of the Products in places subject to dew condensation
- The Products are not subject to radiation-proof design.
- Please verify and confirm characteristics of the final or mounted products in using the Products.
- In particular, if a transient load (a large amount of load applied in a short period of time, such as pulse. is applied, confirmation of performance characteristics after on-board mounting is strongly recommended. Avoid applying power exceeding normal rated power; exceeding the power rating under steady-state loading condition may negatively affect product performance and reliability.
- De-rate Power Dissipation (Pd) depending on Ambient temperature (Ta). When used in sealed area, confirm the actual ambient temperature.
- Confirm that operation temperature is within the specified range described in the product specification.
- ROHM shall not be in any way responsible or liable for failure induced under deviant condition from what is defined in this document.

Precaution for Mounting / Circuit board design

- When a highly active halogenous (chlorine, bromine, etc.) flux is used, the residue of flux may negatively affect product performance and reliability.
- In principle, the reflow soldering method must be used on a surface-mount products, the flow soldering method must be used on a through hole mount products. If the flow soldering method is preferred on a surface-mount products, please consult with the ROHM representative in advance.

For details, please refer to ROHM Mounting specification

Precautions Regarding Application Examples and External Circuits

1. If change is made to the constant of an external circuit, please allow a sufficient margin considering variations of the characteristics of the Products and external components, including transient characteristics, as well as static characteristics.
2. You agree that application notes, reference designs, and associated data and information contained in this document are presented only as guidance for Products use. Therefore, in case you use such information, you are solely responsible for it and you must exercise your own independent verification and judgment in the use of such information contained in this document. ROHM shall not be in any way responsible or liable for any damages, expenses or losses incurred by you or third parties arising from the use of such information.

Precaution for Electrostatic

This Product is electrostatic sensitive product, which may be damaged due to electrostatic discharge. Please take proper caution in your manufacturing process and storage so that voltage exceeding the Products maximum rating will not be applied to Products. Please take special care under dry condition (e.g. Grounding of human body / equipment / solder iron, isolation from charged objects, setting of Ionizer, friction prevention and temperature / humidity control).

Precaution for Storage / Transportation

1. Product performance and soldered connections may deteriorate if the Products are stored in the places where:
 - [a] the Products are exposed to sea winds or corrosive gases, including Cl₂, H₂S, NH₃, SO₂, and NO₂
 - [b] the temperature or humidity exceeds those recommended by ROHM
 - [c] the Products are exposed to direct sunshine or condensation
 - [d] the Products are exposed to high Electrostatic
2. Even under ROHM recommended storage condition, solderability of products out of recommended storage time period may be degraded. It is strongly recommended to confirm solderability before using Products of which storage time is exceeding the recommended storage time period.
3. Store / transport cartons in the correct direction, which is indicated on a carton with a symbol. Otherwise bent leads may occur due to excessive stress applied when dropping of a carton.
4. Use Products within the specified time after opening a humidity barrier bag. Baking is required before using Products of which storage time is exceeding the recommended storage time period.

Precaution for Product Label

QR code printed on ROHM Products label is for ROHM's internal use only.

Precaution for Disposition

When disposing Products please dispose them properly using an authorized industry waste company.

Precaution for Foreign Exchange and Foreign Trade act

Since concerned goods might be fallen under listed items of export control prescribed by Foreign exchange and Foreign trade act, please consult with ROHM in case of export.

Precaution Regarding Intellectual Property Rights

1. All information and data including but not limited to application example contained in this document is for reference only. ROHM does not warrant that foregoing information or data will not infringe any intellectual property rights or any other rights of any third party regarding such information or data.
2. ROHM shall not have any obligations where the claims, actions or demands arising from the combination of the Products with other articles such as components, circuits, systems or external equipment (including software).
3. No license, expressly or implied, is granted hereby under any intellectual property rights or other rights of ROHM or any third parties with respect to the Products or the information contained in this document. Provided, however, that ROHM will not assert its intellectual property rights or other rights against you or your customers to the extent necessary to manufacture or sell products containing the Products, subject to the terms and conditions herein.

Other Precaution



1. This document may not be reprinted or reproduced, in whole or in part, without prior written consent of ROHM.
2. The Products may not be disassembled, converted, modified, reproduced or otherwise changed without prior written consent of ROHM.
3. In no event shall you use in any way whatsoever the Products and the related technical information contained in the Products or this document for any military purposes, including but not limited to, the development of mass-destruction weapons.
4. The proper names of companies or products described in this document are trademarks or registered trademarks of ROHM, its affiliated companies or third parties.

General Precaution







1. Before you use our Products, you are requested to carefully read this document and fully understand its contents. ROHM shall not be in any way responsible or liable for failure, malfunction or accident arising from the use of any ROHM's Products against warning, caution or note contained in this document.
2. All information contained in this document is current as of the issuing date and subject to change without any prior notice. Before purchasing or using ROHM's Products, please confirm the latest information with a ROHM sales representative.
3. The information contained in this document is provided on an "as is" basis and ROHM does not warrant that all information contained in this document is accurate and/or error-free. ROHM shall not be in any way responsible or liable for any damages, expenses or losses incurred by you or third parties resulting from inaccuracy or errors of or concerning such information.

Looking for pricing, stock, or lifecycle information?

Click below to explore more details on WIN SOURCE:

-  [View BA2903HFVM-CTR on WIN SOURCE](#)
-  [Rohm Semiconductor](#) Information

Optimize Your Supply Chain with WIN SOURCE Solutions

-  Global Sourcing Solution
-  Obsolete Management
-  Cost Control Management
-  Shortage Management
-  Alternative Solution
-  Excess Inventory Management