

Aluminum electrolytic capacitors Alu-X product lines

Snap-in capacitors

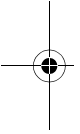

Series/Type: B43254
Date: April 2008

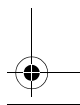
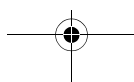
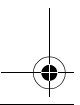
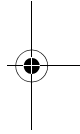



Snap-in capacitors

B43254

Standard series – 105 °C

Long life grade capacitors

Applications

- Switch-mode power supplies in industrial and entertainment electronics

Features

- High ripple current capability
- RoHS-compatible
- Long load life of 3000 h at 105 °C



Construction

- Aluminum case, fully insulated
- Snap-in solder pins to hold component in place on PC-board
- Minus pole marking on the insulating sleeve
- Case with safety vent

Specifications and characteristics in brief

Rated voltage V_R	160 ... 450 V DC				
Operating temperature range	$V_R \leq 250$ V DC: -40 °C ... $+105$ °C $V_R \geq 350$ V DC: -25 °C ... $+105$ °C				
Rated capacitance C_R (20 °C, 120 Hz)	47 ... 2700 μ F				
Capacitance tolerance	$\pm 20\% \triangleq M$				
Load life (105 °C, V_R , $I_{AC,R}$)	3000 h	Requirements: $\Delta C/C \leq \pm 20\%$ of initial value $\tan \delta \leq 2$ times initial specified limit $I_{leak} \leq$ initial specified limit			
Leakage current I_{leak} (20 °C, after 5 minutes)	$I_{leak} \leq 3 \mu A \cdot \sqrt{\frac{C_R}{\mu F} \cdot \frac{V_R}{V}}$				
Dissipation factor (max.) (20 °C, 120 Hz)	V_R (V DC)	160 ... 400	450		
	$\tan \delta$	0.15	0.20		
Low temperature stability (impedance ratio) (120 Hz)	V_R (V DC)	160 ... 400	450		
	$\frac{Z(-25 \text{ °C})}{Z(+20 \text{ °C})}$	4	8		
Shelf life	After storage for 1000 h at 105 °C, the capacitors shall meet the requirement of load life test after reforming process. After test: V_R to be applied for 30 minutes, 24 to 48 hours before measurement.				
Frequency multiplier for rated ripple current	50 Hz	120 Hz	1 kHz	10 kHz	20 kHz
	0.90	1.00	1.20	1.50	1.55
Temperature multiplier for rated ripple current	+40 °C	+55 °C	+70 °C	+85 °C	+105 °C
	2.7	2.5	2.1	1.7	1.0

Please read *Cautions and warnings* and *Important notes* at the end of this document.



Snap-in capacitors
Standard series – 105 °C

B43254

Dimensional drawing

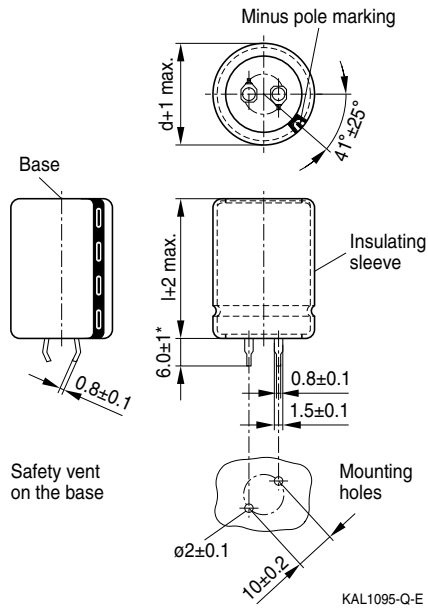

* = Shorter terminal (4.0 ± 0.5) is also available upon request.

Please read *Cautions and warnings* and *Important notes* at the end of this document.



Snap-in capacitors

B43254

Standard series – 105 °C

Overview of available types B43254

V_R (V DC)	160	200	250	350	400	450
	Case dimensions $d \times l$ (mm)					
C_R (μ F)						
47					22 × 20	
56				22 × 20	22 × 20 25.4 × 20	22 × 25
68				22 × 20 25.4 × 20	22 × 25 25.4 × 20	22 × 30 25.4 × 25
82				22 × 25 25.4 × 20	22 × 25 25.4 × 25 30 × 20	22 × 30 25.4 × 25
100				22 × 25 25.4 × 25 30 × 20	22 × 30 25.4 × 25 30 × 20	22 × 35 25.4 × 30 30 × 25
120			22 × 20	22 × 30 25.4 × 25 30 × 20	22 × 35 25.4 × 25 30 × 25 35 × 20	22 × 40 25.4 × 30 30 × 25 35 × 25
150		22 × 20	22 × 25 25.4 × 20	22 × 35 25.4 × 30 30 × 25 35 × 20	22 × 40 25.4 × 30 30 × 25 35 × 20	22 × 45 25.4 × 40 30 × 30 35 × 25
180		22 × 20 25.4 × 20	22 × 25 25.4 × 20	22 × 40 25.4 × 30 30 × 25 35 × 20	22 × 45 25.4 × 35 30 × 30 35 × 25	22 × 50 25.4 × 40 30 × 30 35 × 25
220	22 × 20	22 × 25 25.4 × 20	22 × 25 25.4 × 25 30 × 20	22 × 45 25.4 × 35 30 × 30 35 × 25	22 × 50 25.4 × 40 30 × 30 35 × 25	25.4 × 50 30 × 35 35 × 25
270	22 × 25 25.4 × 20	22 × 25 25.4 × 25 30 × 20	22 × 30 25.4 × 25 30 × 20	22 × 50 25.4 × 40 30 × 30 35 × 25	25.4 × 45 30 × 35 35 × 30	30 × 40 35 × 30
330	22 × 25 25.4 × 20	22 × 30 25.4 × 25 30 × 20	22 × 35 25.4 × 30 30 × 25 35 × 20	25.4 × 45 30 × 35 35 × 30	25.4 × 50 30 × 40 35 × 30	30 × 45 35 × 35
390	22 × 25 25.4 × 25 30 × 20	22 × 30 25.4 × 25 30 × 25 35 × 20	22 × 40 25.4 × 35 30 × 25 35 × 25	25.4 × 50 30 × 40 35 × 35	30 × 45 35 × 35	30 × 50 35 × 40
470	22 × 30 25.4 × 25 30 × 20	22 × 35 25.4 × 30 30 × 25 35 × 20	22 × 45 25.4 × 35 30 × 30 35 × 25	30 × 45 35 × 35	30 × 50 35 × 40	35 × 45

Please read *Cautions and warnings* and *Important notes* at the end of this document.



Snap-in capacitors

B43254

Standard series – 105 °C

Overview of available types B43254

V_R (V DC)	160	200	250	350	400	450
	Case dimensions $d \times l$ (mm)					
C_R (μ F)						
560	22 × 35 25.4 × 30 30 × 25 35 × 20	22 × 40 25.4 × 30 30 × 25 35 × 25	22 × 50 25.4 × 40 30 × 30 35 × 25	30 × 50 35 × 40	35 × 45	35 × 50
680	22 × 40 25.4 × 30 30 × 25 35 × 20	22 × 45 25.4 × 35 30 × 30 35 × 25	25.4 × 50 30 × 35 35 × 30	35 × 50	35 × 50	
820	22 × 45 25.4 × 35 30 × 30 35 × 25	25.4 × 45 30 × 30 35 × 25	30 × 40 35 × 35			
1000	22 × 50 25.4 × 40 30 × 30 35 × 25	25.4 × 50 30 × 35 35 × 30	30 × 50 35 × 40			
1200	25.4 × 45 30 × 35 35 × 30	30 × 40 35 × 35	30 × 60 35 × 45			
1500	25.4 × 50 30 × 40 35 × 30	30 × 50 35 × 40	35 × 50			
1800	30 × 45 35 × 35	35 × 45				
2200	30 × 50 35 × 45	35 × 50				
2700	35 × 50					

Please read *Cautions and warnings* and *Important notes* at the end of this document.



Snap-in capacitors

B43254

Standard series – 105 °C

Technical data and ordering codes

V _R V DC	C _R 120 Hz 20 °C μF	Case dimensions d × l mm	I _{AC,R} 120 Hz 105 °C A	Ordering code
160	220	22 × 20	0.76	B43254A1227M000
	270	22 × 25	0.91	B43254A1277M000
	270	25.4 × 20	0.93	B43254B1277M000
	330	22 × 25	1.01	B43254A1337M000
	330	25.4 × 20	1.03	B43254B1337M000
	390	22 × 25	1.09	B43254A1397M000
	390	25.4 × 25	1.20	B43254B1397M000
	390	30 × 20	1.23	B43254C1397M000
	470	22 × 30	1.28	B43254A1477M000
	470	25.4 × 25	1.32	B43254B1477M000
	470	30 × 20	1.35	B43254C1477M000
	560	22 × 35	1.48	B43254A1567M000
	560	25.4 × 30	1.53	B43254B1567M000
	560	30 × 25	1.57	B43254C1567M000
	560	35 × 20	1.60	B43254D1567M000
	680	22 × 40	1.72	B43254A1687M000
	680	25.4 × 30	1.69	B43254B1687M000
	680	30 × 25	1.73	B43254C1687M000
	680	35 × 20	1.76	B43254D1687M000
	820	22 × 45	1.98	B43254A1827M000
	820	25.4 × 35	1.96	B43254B1827M000
	820	30 × 30	2.02	B43254C1827M000
	820	35 × 25	2.06	B43254D1827M000
	1000	22 × 50	2.28	B43254A1108M000
	1000	25.4 × 40	2.28	B43254B1108M000
	1000	30 × 30	2.23	B43254C1108M000
	1000	35 × 25	2.28	B43254D1108M000
	1200	25.4 × 45	2.41	B43254A1128M000
	1200	30 × 35	2.38	B43254B1128M000
	1200	35 × 30	2.44	B43254C1128M000
	1500	25.4 × 50	2.81	B43254A1158M000
	1500	30 × 40	2.79	B43254B1158M000
	1500	35 × 30	2.73	B43254C1158M000
	1800	30 × 45	3.19	B43254A1188M000
	1800	35 × 35	3.14	B43254B1188M000
	2200	30 × 50	3.44	B43254A1228M000
	2200	35 × 45	3.55	B43254B1228M000
	2700	35 × 50	4.08	B43254A1278M000

Please read *Cautions and warnings* and
Important notes at the end of this document.



Snap-in capacitors

B43254

Standard series – 105 °C

Technical data and ordering codes

V _R	C _R 120 Hz 20 °C	Case dimensions d × l mm	I _{AC,R} 120 Hz 105 °C A	Ordering code
V DC	μF			
200	150	22 × 20	0.63	B43254A2157M000
	180	22 × 20	0.69	B43254A2187M000
	180	25.4 × 20	0.76	B43254B2187M000
	220	22 × 25	0.82	B43254A2227M000
	220	25.4 × 20	0.84	B43254B2227M000
	270	22 × 25	0.91	B43254A2277M000
	270	25.4 × 25	1.00	B43254B2277M000
	270	30 × 20	1.02	B43254C2277M000
	330	22 × 30	1.07	B43254A2337M000
	330	25.4 × 25	1.11	B43254B2337M000
	330	30 × 20	1.13	B43254C2337M000
	390	22 × 30	1.17	B43254A2397M000
	390	25.4 × 25	1.20	B43254B2397M000
	390	30 × 25	1.31	B43254C2397M000
	390	35 × 20	1.34	B43254D2397M000
	470	22 × 35	1.36	B43254A2477M000
	470	25.4 × 30	1.40	B43254B2477M000
	470	30 × 25	1.44	B43254C2477M000
	470	35 × 20	1.47	B43254D2477M000
	560	22 × 40	1.56	B43254A2567M000
	560	25.4 × 30	1.53	B43254B2567M000
	560	30 × 25	1.57	B43254C2567M000
	560	35 × 25	1.70	B43254D2567M000
	680	22 × 45	1.80	B43254A2687M000
	680	25.4 × 35	1.79	B43254B2687M000
	680	30 × 30	1.84	B43254C2687M000
	680	35 × 25	1.88	B43254D2687M000
	820	25.4 × 45	2.16	B43254A2827M000
	820	30 × 30	2.02	B43254B2827M000
	820	35 × 25	2.06	B43254C2827M000
	1000	25.4 × 50	2.48	B43254A2108M000
	1000	30 × 35	2.35	B43254B2108M000
	1000	35 × 30	2.41	B43254C2108M000
	1200	30 × 40	2.50	B43254A2128M000
	1200	35 × 35	2.57	B43254B2128M000
	1500	30 × 50	3.04	B43254A2158M000
	1500	35 × 40	3.00	B43254B2158M000
	1800	35 × 45	3.43	B43254A2188M000
	2200	35 × 50	3.68	B43254A2228M000

Please read *Cautions and warnings* and
Important notes at the end of this document.



Snap-in capacitors

B43254

Standard series – 105 °C

Technical data and ordering codes

V _R	C _R 120 Hz 20 °C	Case dimensions d × l mm	I _{AC,R} 120 Hz 105 °C A	Ordering code
V DC	μF			
250	120	22 × 20	0.56	B43254E2127M000
	150	22 × 25	0.68	B43254E2157M000
	150	25.4 × 20	0.69	B43254F2157M000
	180	22 × 25	0.74	B43254E2187M000
	180	25.4 × 20	0.76	B43254F2187M000
	220	22 × 25	0.82	B43254E2227M000
	220	25.4 × 25	0.90	B43254F2227M000
	220	30 × 20	0.92	B43254C2227M000
	270	22 × 30	0.97	B43254E2277M000
	270	25.4 × 25	1.00	B43254F2277M000
	270	30 × 20	1.02	B43254G2277M000
	330	22 × 35	1.14	B43254E2337M000
	330	25.4 × 30	1.18	B43254F2337M000
	330	30 × 25	1.21	B43254G2337M000
	330	35 × 20	1.23	B43254D2337M000
	390	22 × 40	1.30	B43254E2397M000
	390	25.4 × 35	1.35	B43254F2397M000
	390	30 × 25	1.31	B43254G2397M000
	390	35 × 25	1.42	B43254H2397M000
	470	22 × 45	1.50	B43254E2477M000
	470	25.4 × 35	1.48	B43254F2477M000
	470	30 × 30	1.53	B43254G2477M000
	470	35 × 25	1.56	B43254H2477M000
	560	22 × 50	1.71	B43254E2567M000
	560	25.4 × 40	1.70	B43254F2567M000
	560	30 × 30	1.67	B43254G2567M000
	560	35 × 25	1.70	B43254H2567M000
	680	25.4 × 50	2.05	B43254E2687M000
	680	30 × 35	1.94	B43254F2687M000
	680	35 × 30	1.98	B43254G2687M000
	820	30 × 40	2.23	B43254E2827M000
	820	35 × 35	2.29	B43254F2827M000
	1000	30 × 50	2.68	B43254E2108M000
	1000	35 × 40	2.65	B43254F2108M000
	1200	30 × 60	2.92	B43254E2128M000
	1200	35 × 45	2.80	B43254F2128M000
	1500	35 × 50	3.25	B43254E2158M000

Please read *Cautions and warnings* and
Important notes at the end of this document.



Snap-in capacitors

B43254

Standard series – 105 °C

Technical data and ordering codes

V _R V DC	C _R 120 Hz 20 °C μF	Case dimensions d × l mm	I _{AC,R} 120 Hz 105 °C A	Ordering code
350	56	22 × 20	0.37	B43254A4566M000
	68	22 × 20	0.41	B43254A4686M000
	68	25.4 × 20	0.45	B43254B4686M000
	82	22 × 25	0.48	B43254A4826M000
	82	25.4 × 20	0.49	B43254B4826M000
	100	22 × 25	0.53	B43254A4107M000
	100	25.4 × 25	0.58	B43254B4107M000
	100	30 × 20	0.60	B43254C4107M000
	120	22 × 30	0.62	B43254A4127M000
	120	25.4 × 25	0.64	B43254B4127M000
	120	30 × 20	0.65	B43254C4127M000
	150	22 × 35	0.74	B43254A4157M000
	150	25.4 × 30	0.76	B43254B4157M000
	150	30 × 25	0.78	B43254C4157M000
	150	35 × 20	0.80	B43254D4157M000
	180	22 × 40	0.85	B43254A4187M000
	180	25.4 × 30	0.83	B43254B4187M000
	180	30 × 25	0.86	B43254C4187M000
	180	35 × 20	0.87	B43254D4187M000
	220	22 × 45	0.98	B43254A4227M000
	220	25.4 × 35	0.98	B43254B4227M000
	220	30 × 30	1.00	B43254C4227M000
	220	35 × 25	1.03	B43254D4227M000
	270	22 × 50	1.14	B43254A4277M000
	270	25.4 × 40	1.14	B43254B4277M000
	270	30 × 30	1.11	B43254C4277M000
	270	35 × 25	1.14	B43254D4277M000
	330	25.4 × 45	1.31	B43254A4337M000
	330	30 × 35	1.30	B43254B4337M000
	330	35 × 30	1.33	B43254C4337M000
	390	25.4 × 50	1.49	B43254A4397M000
	390	30 × 40	1.48	B43254B4397M000
	390	35 × 35	1.52	B43254C4397M000
	470	30 × 45	1.69	B43254A4477M000
	470	35 × 35	1.67	B43254B4477M000
	560	30 × 50	1.92	B43254A4567M000
	560	35 × 40	1.90	B43254B4567M000
	680	35 × 50	2.27	B43254A4687M000

Please read *Cautions and warnings* and
Important notes at the end of this document.

9 04/08



Snap-in capacitors

B43254

Standard series – 105 °C

Technical data and ordering codes

V _R V DC	C _R 120 Hz 20 °C μF	Case dimensions d × l mm	I _{AC,R} 120 Hz 105 °C A	Ordering code
400	47	22 × 20	0.34	B43254A9476M000
	56	22 × 20	0.37	B43254A9566M000
	56	25.4 × 20	0.41	B43254B9566M000
	68	22 × 25	0.44	B43254A9686M000
	68	25.4 × 20	0.45	B43254B9686M000
	82	22 × 25	0.48	B43254A9826M000
	82	25.4 × 25	0.53	B43254B9826M000
	82	30 × 20	0.54	B43254C9826M000
	100	22 × 30	0.57	B43254A9107M000
	100	25.4 × 25	0.58	B43254B9107M000
	100	30 × 20	0.60	B43254C9107M000
	120	22 × 35	0.66	B43254A9127M000
	120	25.4 × 25	0.64	B43254B9127M000
	120	30 × 25	0.70	B43254C9127M000
	120	35 × 20	0.71	B43254D9127M000
	150	22 × 40	0.78	B43254A9157M000
	150	25.4 × 30	0.76	B43254B9157M000
	150	30 × 25	0.78	B43254C9157M000
	150	35 × 20	0.80	B43254D9157M000
	180	22 × 45	0.89	B43254A9187M000
	180	25.4 × 35	0.88	B43254B9187M000
	180	30 × 30	0.91	B43254C9187M000
	180	35 × 25	0.93	B43254D9187M000
	220	22 × 50	1.03	B43254A9227M000
	220	25.4 × 40	1.03	B43254B9227M000
	220	30 × 30	1.00	B43254C9227M000
	220	35 × 25	1.03	B43254D9227M000
	270	25.4 × 45	1.19	B43254A9277M000
	270	30 × 35	1.17	B43254B9277M000
	270	35 × 30	1.20	B43254C9277M000
	330	25.4 × 50	1.37	B43254A9337M000
	330	30 × 40	1.36	B43254B9337M000
	330	35 × 30	1.33	B43254C9337M000
	390	30 × 45	1.54	B43254A9397M000
	390	35 × 35	1.52	B43254B9397M000
	470	30 × 50	1.76	B43254A9477M000
	470	35 × 40	1.74	B43254B9477M000
	560	35 × 45	1.98	B43254A9567M000
	680	35 × 50	2.27	B43254A9687M000

Please read *Cautions and warnings* and
Important notes at the end of this document.



Snap-in capacitors

B43254

Standard series – 105 °C

Technical data and ordering codes

V _R V DC	C _R 120 Hz 20 °C μF	Case dimensions d × l mm	I _{AC,R} 120 Hz 105 °C A	Ordering code
450	56	22 × 25	0.29	B43254A5566M000
	68	22 × 30	0.34	B43254A5686M000
	68	25.4 × 25	0.35	B43254B5686M000
	82	22 × 30	0.38	B43254A5826M000
	82	25.4 × 25	0.39	B43254B5826M000
	100	22 × 35	0.44	B43254A5107M000
	100	25.4 × 30	0.46	B43254B5107M000
	100	30 × 25	0.47	B43254C5107M000
	120	22 × 40	0.51	B43254A5127M000
	120	25.4 × 30	0.50	B43254B5127M000
	120	30 × 25	0.51	B43254C5127M000
	120	35 × 25	0.56	B43254D5127M000
	150	22 × 45	0.60	B43254A5157M000
	150	25.4 × 40	0.62	B43254B5157M000
	150	30 × 30	0.61	B43254C5157M000
	150	35 × 25	0.62	B43254D5157M000
	180	22 × 50	0.68	B43254A5187M000
	180	25.4 × 40	0.68	B43254B5187M000
	180	30 × 30	0.67	B43254C5187M000
	180	35 × 25	0.68	B43254D5187M000
	220	25.4 × 50	0.79	B43254A5227M000
	220	30 × 35	0.78	B43254B5227M000
	220	35 × 25	0.75	B43254C5227M000
	270	30 × 40	0.90	B43254A5277M000
	270	35 × 30	0.88	B43254B5277M000
	330	30 × 45	1.04	B43254A5337M000
	330	35 × 35	1.03	B43254B5337M000
	390	30 × 50	1.18	B43254A5397M000
	390	35 × 40	1.17	B43254B5397M000
	470	35 × 45	1.34	B43254A5477M000
	560	35 × 50	1.52	B43254A5567M000

Please read *Cautions and warnings* and
Important notes at the end of this document.



Cautions and warnings

General

Also see "Important notes" on page 14.

- 1 Aluminum electrolytic capacitors have a bi-polar structure. This is marked on the body of the capacitor. A capacitor must not be mounted with reversed polarity. The application of an AC or reverse voltage may cause a short circuit or damage the capacitor. Bi-polar capacitors must not be used in AC applications, where the polarity may be reversed in the circuits or is unknown.
- 2 The DC voltage applied to the capacitor terminal must not exceed its rated operating voltage, as this will result in a rapid increase of the leakage current and may damage the capacitor. It is recommended to operate the capacitor at 70–80% of its rated voltage to optimize its service life.
- 3 The ripple current applied to the capacitor must be within the permitted range. An excessive ripple current leads to impaired electrical properties and may damage the capacitor. Note that the sum of the peak values of the ripple voltage and the DC operating voltage must not exceed the rated DC voltage.
- 4 Capacitors must be used within their permitted range of operating temperature. Operation at room temperature optimizes their service life.
- 5 Capacitors with case diameter ≥ 8 mm are equipped with a safety vent. In capacitors fitted with a lead or soldering lug, the safety vent is usually located at the base of the case. It needs sufficient space around it to operate optimally. The following dimensions are recommended: for case diameter $d = 8$ to 16 mm, more than 2 mm; for $d = 18$ to 35 mm, more than 3 mm; and for $d = 42$ mm or more, more than 5 mm.
- 6 Capacitors should not be mounted with the safety vent face down on the board. Do not locate any wire or copper trace near the safety vent. Do not reverse the voltage, as this may result in excess pressure and the leakage of electrolyte.
- 7 Gas is released through the safety vent when the pressure inside the capacitor is too high. A gaseous liquid around the safety vent does not indicate a leakage of electrolyte.
- 8 The capacitor should be stored under conditions of normal temperature and in a non-acid, non-alkali environment of normal humidity. Exposure to high temperatures, for example under direct sunlight, will reduce its operating life. If the capacitor is stored in an environment containing acids or alkalis, the solderability of the leads may be affected.
- 9 The leakage current of an aluminum electrolytic capacitor may increase after a long period of storage. After such storage, the capacitor must be aged by applying the rated operating voltage for 6–8 hours before use.
- 10 Manual soldering:
 - a Soldering must be performed within the specified conditions.
Bit temperature: 350 °C; application time of soldering iron: 3 seconds.
 - b Ensure that the soldering iron does not touch any part of the capacitor body.

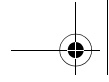

Cautions and warnings

- 11 Do not apply excessive force to the leads and terminals. Do not move the capacitor after soldering it onto the PC board and do not carry the PC board by gripping the capacitor. Observe the following rules to prevent undue stress to the capacitor:
 - a Do not tilt or bend the capacitor after soldering.
 - b Ensure that the terminal spacing matches the corresponding hole spacing on the PC board.
- 12 The aluminum case is not insulated from the cathode. Do not place a conductor under the aluminum capacitors on the PC board as this may cause a short circuit. The case and top of capacitors used in switched mode power supplies have a high-voltage-resistant heat shrink sleeve to ensure safe usage.
- 13 The leads of capacitors with a case diameter exceeding 14 mm cannot be used for fixing.

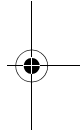
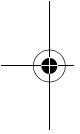

Please read *Cautions and warnings* and *Important notes* at the end of this document.

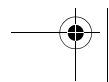
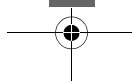





Important notes

The following applies to all products named in this publication:

1. Some parts of this publication contain **statements about the suitability of our products for certain areas of application**. These statements are based on our knowledge of typical requirements that are often placed on our products in the areas of application concerned. We nevertheless expressly point out **that such statements cannot be regarded as binding statements about the suitability of our products for a particular customer application**. As a rule, EPCOS is either unfamiliar with individual customer applications or less familiar with them than the customers themselves. For these reasons, it is always ultimately incumbent on the customer to check and decide whether an EPCOS product with the properties described in the product specification is suitable for use in a particular customer application.
2. We also point out that **in individual cases, a malfunction of electronic components or failure before the end of their usual service life cannot be completely ruled out in the current state of the art, even if they are operated as specified**. In customer applications requiring a very high level of operational safety and especially in customer applications in which the malfunction or failure of an electronic component could endanger human life or health (e.g. in accident prevention or life-saving systems), it must therefore be ensured by means of suitable design of the customer application or other action taken by the customer (e.g. installation of protective circuitry or redundancy) that no injury or damage is sustained by third parties in the event of malfunction or failure of an electronic component.
3. **The warnings, cautions and product-specific notes must be observed.**
4. In order to satisfy certain technical requirements, **some of the products described in this publication may contain substances subject to restrictions in certain jurisdictions (e.g. because they are classed as hazardous)**. Useful information on this will be found in our Material Data Sheets on the Internet (www.epcos.com/material). Should you have any more detailed questions, please contact our sales offices.
5. We constantly strive to improve our products. Consequently, **the products described in this publication may change from time to time**. The same is true of the corresponding product specifications. Please check therefore to what extent product descriptions and specifications contained in this publication are still applicable before or when you place an order.
We also **reserve the right to discontinue production and delivery of products**. Consequently, we cannot guarantee that all products named in this publication will always be available. The aforementioned does not apply in case of individual agreements deviating from the foregoing for customer-specific products.
6. Unless otherwise agreed in individual contracts, **all orders are subject to the current version of the "General Terms of Delivery for Products and Services in the Electrical Industry" published by the German Electrical and Electronics Industry Association (ZVEI)**.
7. The trade names EPCOS, BAOKE, Alu-X, CeraDiode, CSSP, CTVS, DSSP, MiniBlue, MKK, MLSC, MotorCap, PCC, PhaseCap, PhaseMod, SIFERRIT, SIFI, SIKOREL, SilverCap, SIMDAD, SIMID, SineFormer, SIOV, SIP5D, SIP5K, ThermoFuse, WindCap are **trademarks registered or pending** in Europe and in other countries. Further information will be found on the Internet at www.epcos.com/trademarks.

Looking for pricing, stock, or lifecycle information?

Click below to explore more details on WIN SOURCE:

-  [View B43254B4686M on WIN SOURCE](#)
-  [EPCOS \(TDK\) Information](#)

Optimize Your Supply Chain with WIN SOURCE Solutions

-  Global Sourcing Solution
-  Obsolete Management
-  Cost Control Management
-  Shortage Management
-  Alternative Solution
-  Excess Inventory Management