



**THE DATASHEET OF  
AUIR33401STRL**



## PROTECTED HIGH SIDE SWITCH FOR AUTOMOTIVE DC MOTOR DRIVE

### Features

- Up to 20Khz PWM switching capability
- Charge pump for DC operation
- Active Dv/Dt control
- Load current feedback
- Short-circuit protection
- Programmable over current shutdown
- Over temperature shutdown
- Under voltage shutdown
- Gnd, IN and bootstrap pin loss protection
- E.S.D protection
- Low power mode
- Leadfree, RoHS compliant
- Automotive qualified\*

### Description

The AUIR33401S is a 7 terminals high side switch for variable speed DC motor. It features simplify the design of the DC motor drive with a microcontroller. The Mosfet switches the power load proportionally to the input signal duty cycle at the same frequency and provides a current feedback on the I<sub>fbk</sub> pin. The over-current shutdown is programmable from 10A to 33A. Over-current and over-temperature latch OFF the power switch, providing a digital diagnostic status on the input pin. In sleep mode, the device consumes less than 10uA.

Further integrated protections such as ESD, GND and Cboot disconnect protection guarantee safe operation in harsh conditions of the automotive environment.

### Product Summary

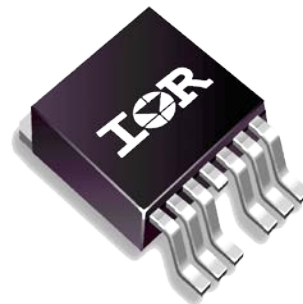
R <sub>ds(on)</sub> @25°C	3.5mΩ max.
Max current	33A
Operating voltage	6 – 18V

### Application

- Fan engine cooling
- Air conditioning blower
- Pumps (oil, fuel, water...)
- Compressor

### Package

D2Pak - 7 leads



**Qualification Information<sup>†</sup>**

<b>Qualification Level</b>		Automotive (per AEC-Q100 <sup>††</sup> )	
		Comments: This family of ICs has passed an Automotive qualification. IR's Industrial and Consumer qualification level is granted by extension of the higher Automotive level.	
<b>Moisture Sensitivity Level</b>		7L-DDPAK	MSL1, 260°C (per IPC/JEDEC J-STD-020)
<b>ESD</b>	Machine Model	Class M3 (per AEC-Q-100-003)	
	Human Body Model	Class H2 (per AEC-Q-100-002)	
	Charged Device Model	Class C5 (per AEC-Q-100-011)	
<b>RoHS Compliant</b>		Yes	

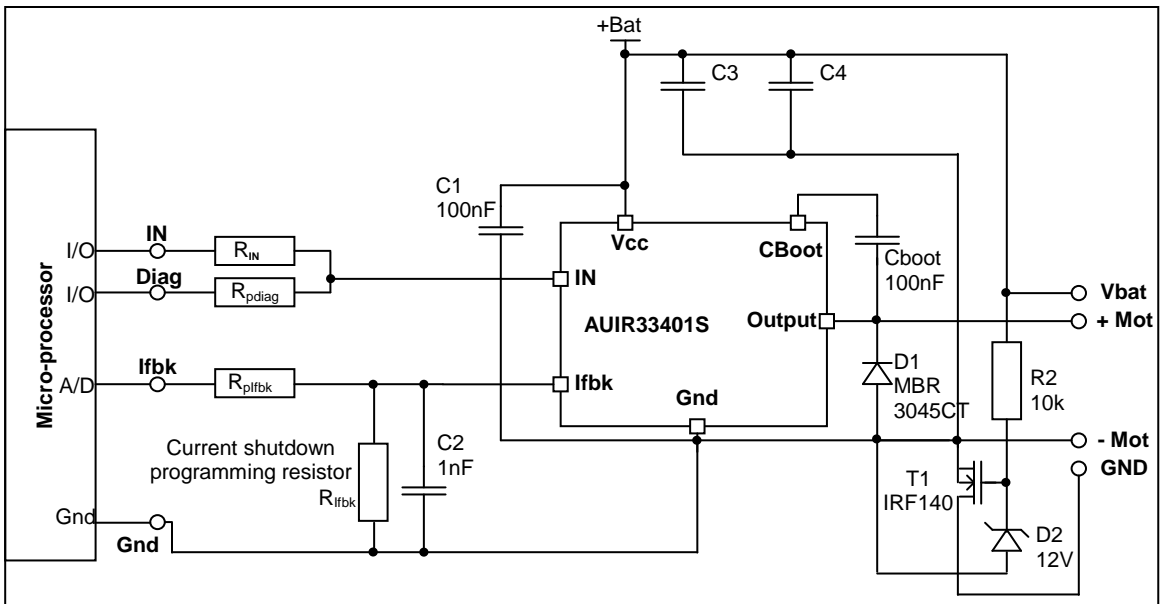
<sup>†</sup> Qualification standards can be found at International Rectifier's web site <http://www.irf.com/>

<sup>††</sup> Exceptions to AEC-Q100 requirements are noted in the qualification report.

## Design: basic schematic with micro-processor

The basic circuit is giving all the functionality to drive a motor up to 33A DC.  $R_{ifbk}$  set both the level current shutdown and the current feedback reading scale. The IN signal provides to the AUIR33401S the Pwm duty cycle. D1 is the free wheeling diode during PWM operation. As the equivalent circuit between Vbat and - Mot is 2 diode in series (the body diode of the AUIR33401S and D1), the system requires T1, D2, R1 and R2 to sustain the reverse battery.

## Recommended connection with reverse battery protection<sup>1</sup>:



**Figure 1: Recommended schematic**

This is the recommended schematic with an optional reverse battery<sup>1</sup>. The recommended load is an inductive load. This part may not be suitable for application conditions other than those specified above. Please contact IR's Automotive Technical support for further details on other applications requirement.

## DC to 20 kHz operation

The AUIR33401S is able to operate in DC and high speed switching operation. To be able to switch at 20 kHz, a bootstrap capacitor is used externally. The device integrates the power supply of the bootstrap capacitor. In DC operation, when the capacitor is discharged, the charge pump maintains the device ON.

<sup>1</sup> The reverse battery is optional. Remove T1, D2, R2 and connect -Mot to Gnd to remove the features.

## Active dv/dt control to reduce EMI Typical Connection

The AUIR33401S includes a special gate drive, managing the Mosfet dv/dt controlled internally, by managing the gate voltage dynamically. To have the best compromise between the EMI levels and power loss, during the turn on and off phase, the dv/dt output is dv/dt is not linear. The output voltage shape is an “S” shape.

## Sense Load current feedback and programmable current shutdown

The I<sub>fbk</sub> pin allows an analog measurement of the load current and with an external resistor allows to program the over current shutdown level from 10A to 33A. The voltage threshold level of the I<sub>fbk</sub> pin is internally set to 4V (See the formulas below). It is also possible to dynamically adjust the current shutdown protection versus time by adding some external components. This protection is latched. The operating mode is recovered after resetting by the sleep mode.

$$R_{ifbk} = \frac{V_{ifbk} - gnd\ min}{I_{max\ appli} + Offset} \times Ratio\ min$$

$$I_{shd\ max} = \frac{V_{ifbk} - gnd\ max}{R_{ifbk\ calculated}} \times Ratio\ max + Offset$$

Where:

I<sub>max appli</sub> is the maximum application current

I<sub>shd max</sub> is the maximum output shutdown current

## Internal over current shutdown

The maximum current shutdown threshold value is internally fixed to 50A typ. This protection is latched. The operating mode is recovered after resetting by the sleep mode.

## Under voltage lock-out

The AUIR33401S remains operational from UV Lo threshold. Under this continuous voltage, the device will be locked until the voltage recovers the operating range, according to an internal hysteresis fixed to 0,5V min. The maximum rating voltage is given by the Trench VDMOS technology where the avalanche voltage is up to 43V typically.

## Sleep mode and reset fault:

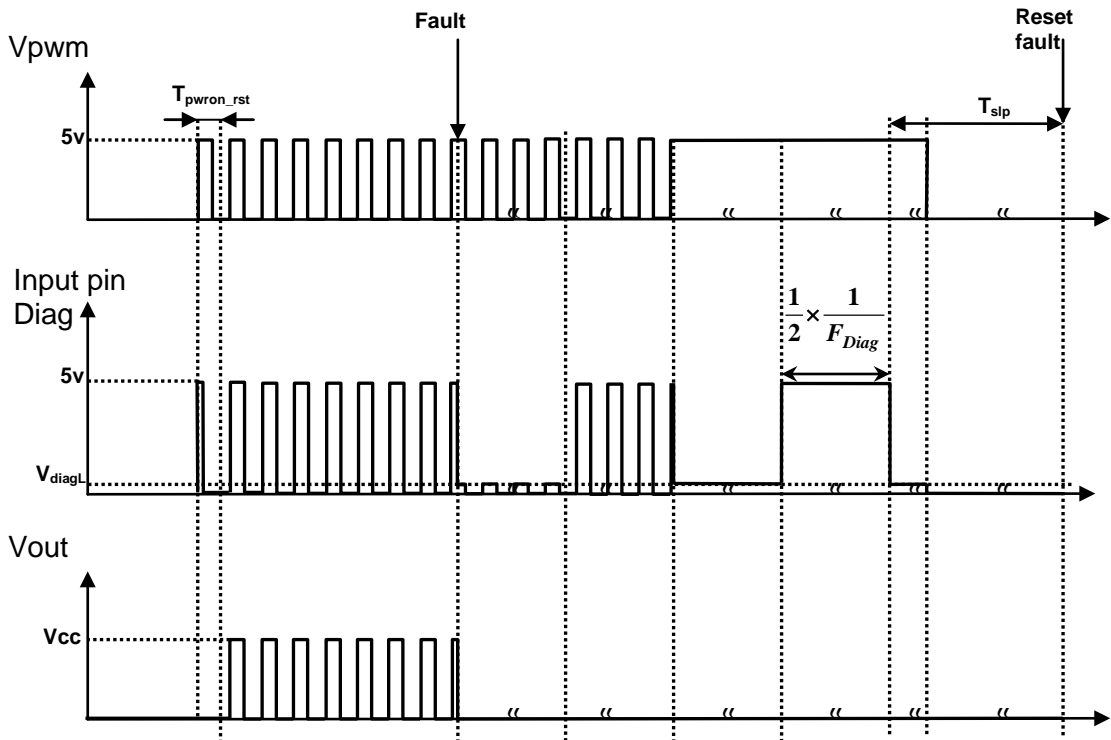
The sleep mode is enabled if the IN pin stay low ( $V_{in} < V_{in\ \mu power}$ ) more than T<sub>slp</sub> time. The consumption in sleep mode is I<sub>cc</sub> off. The AUIR33401S wakes up at first rise edge on the IN pin ( $V_{in} > V_{in\ \mu power}$ ). This mode allows resetting all the latched faults. (Cf. Figure 2: Wake sequence, sleep mode and reset latched fault.)

## Wake up sequence:

The AUIR33401S has a power on reset. After wake up it by the IN signal, the devices wait for T<sub>pwr\_on\_rst</sub> before activate the output power mosfet. This time is necessary to charge properly the bootstrap capacitor and to stabilize the internal power supply. (Cf. Figure 2: Wake sequence, sleep mode and reset latched fault.)

## In pin and digital diagnostic

The IN has two functions. In normal working condition, the output follows the IN pin digital level. In latched fault condition (over current and over temperature shutdown), the IN pin provides a digital frequency signal feedback to the  $\mu$ -processor.



**Figure 2: Wake sequence, sleep mode and reset latched fault.**

## Absolute Maximum Ratings

Absolute maximum ratings indicate sustained limits beyond which damage to the device may occur. All voltage parameters are referenced to Vcc lead. (Tambient=25°C unless otherwise specified).

Symbol	Parameter	Min.	Max.	Units
Vout	Maximum output voltage	Gnd-5v	Vcc+0.3	V
Vin	Maximum input voltage	-0.3	5.5	V
Vcc max.	Maximum Vcc voltage	—	36	V
Vcc cont	Maximum continuous Vcc voltage	—	28	V
Iin, max.	Maximum input current	-0.3	10	mA
Pd	Maximum power dissipation Rth=60°C/W	—	2	W
ESD1	Electrostatic discharge voltage (Human body) C=100pF, R=1500Ω	—	4	kV
ESD2	Charge device model (CDM)	—	1	
Tj max.	Max. storage & operating temperature junction temperature	-40	150	°C
Tsoldering	Soldering temperature (10 seconds)	—	300	°C

## Thermal Characteristics

Symbol	Parameter	Typ.	Max.	Units
Rth1	Thermal resistance junction to ambient	60	—	°C/W
Rth2	Thermal resistance junction to case	0.65	—	

## Recommended Operating Conditions

These values are given for a quick design. For operation outside these conditions, please consult the application notes.

Symbol	Parameter	Min.	Max.	Units
Vcc max.	Power supply voltage	6	18	V
Iout	DC output current Tj=145°C, Tamb=85°C, Rth=5°C/W	—	33	A
Cboot	Bootstrap capacitor	100	220	nF
RIN	Recommended resistor in series with In pin	1	10	kΩ
Rpdiaq	Recommended resistor in series with In pin to read the diagnostic	10	50	kΩ
Rifbk	Recommended resistor to program over current shutdown	0.6	5	kΩ
Rplfbk	Recommended resistor in series with Rifbk pin to read the current feedback	10	25	kΩ
F max.	Maximum input frequency	—	20	kHz

## Static Electrical Characteristics

$T_j=25^\circ\text{C}$ ,  $V_{cc}=14\text{V}$  (unless otherwise specified)

Symbol	Parameter	Min.	Typ.	Max.	Units	Test Conditions
Rds(on)	ON state resistance $T_j=25^\circ\text{C}$	—	3	3.5	m $\Omega$	I <sub>out</sub> =30A
	ON state resistance $T_j=25^\circ\text{C}$	—	3	3.5		I <sub>out</sub> =17A $V_{cc}=6\text{V}$
	ON state resistance $T_j=150^\circ\text{C}$ <sup>2</sup>	—	5.5	—		I <sub>out</sub> =30A
V <sub>f</sub>	Forward voltage of the body diode	0.55	—	1.1	V	
I <sub>cc off</sub>	Supply current in $\mu$ Power mode	—	1	10	$\mu\text{A}$	V <sub>in</sub> =0V
I <sub>cc on</sub>	Gnd current when the device is on	—	3	5	mA	I <sub>Cboot</sub> = 0A Out = 0V
Mos Lkg on	Output leakage when the MOSFET is off and the device is woken up	—	8.5	15	mA	
V <sub>brk</sub>	Breakdown voltage between V <sub>cc</sub> and V <sub>out</sub>	39	43	—	V	
V <sub>in <math>\mu</math>power</sub>	Input threshold voltage to enter in $\mu$ power mode	0.6	0.8	—	V	
V <sub>IL</sub>	IN Low threshold voltage	2	2.5	—	V	
V <sub>IH</sub>	IN High threshold voltage	—	2.8	3	V	
V <sub>in Hyst</sub>	Input hysteresis	0.25	—	0.8	V	
I <sub>in, on</sub>	On state input current	10	20	30	$\mu\text{A}$	V <sub>in</sub> = 5v
I <sub>boot</sub>	Bootstrap current charge	0.5	—	1.3	A	V <sub>out</sub> = 0V C <sub>boot</sub> =500nF
V <sub>boot</sub>	Bootstrap voltage	—	5.4	—	V	
V <sub>diagL</sub>	Low level diagnostic output voltage	—	—	0.4	V	V <sub>in</sub> = 5V R <sub>in</sub> = 1k $\Omega$

## Switching Electrical Characteristics

$V_{cc}=14\text{V}$ , Inductive load= 1 $\Omega$  resistor,  $T_j=25^\circ\text{C}$  (unless otherwise specified)

Symbol	Parameter	Min.	Typ.	Max.	Units	Conditions
T <sub>d on</sub>	Turn-on delay time	0.5	1.35	1.8	$\mu\text{s}$	
T <sub>r</sub>	Rise time	—	1	—	$\mu\text{s}$	
dv/dt(on)	Turn on dv/dt	8	20	30	V/ $\mu\text{s}$	
T <sub>d off</sub>	Turn-off delay time	1.5	2.5	3.8	$\mu\text{s}$	
T <sub>f</sub>	Fall time	—	1	—	$\mu\text{s}$	
dv/dt(off)	Turn off dv/dt	8	20	30	V/ $\mu\text{s}$	

<sup>2</sup> Guaranteed by design

### Protection Characteristics

V<sub>cc</sub>=14V, T<sub>j</sub>=25°C (unless otherwise specified).


Symbol	Parameter	Min.	Typ.	Max.	Units	Conditions
V <sub>fbk - Gnd</sub>	Over current threshold voltage	3.8	4	4.15	V	
I <sub>sd</sub>	Maximum over current shutdown	40	50	80	A	
I <sub>sd 1k</sub>	Current shutdown R <sub>fbk</sub> = 1k	18	25	33	A	
T <sub>sd</sub>	Over temperature threshold	155	165	175	°C	
UV Ho	Under voltage turn on	—	5	5.7	V	
UV Lo	Under voltage turn off	—	4.2	4.8	V	
UV Hyst	Under voltage hysteresis	0.5	0.8	1.5	V	
T <sub>slp</sub>	Sleep mode time and fault reset	20	30	50	ms	
T <sub>pwr on rst</sub>	Power on reset time	7	8.5	15	µs	
Fdiag	diagnostic frequency	—	250	—	Hz	

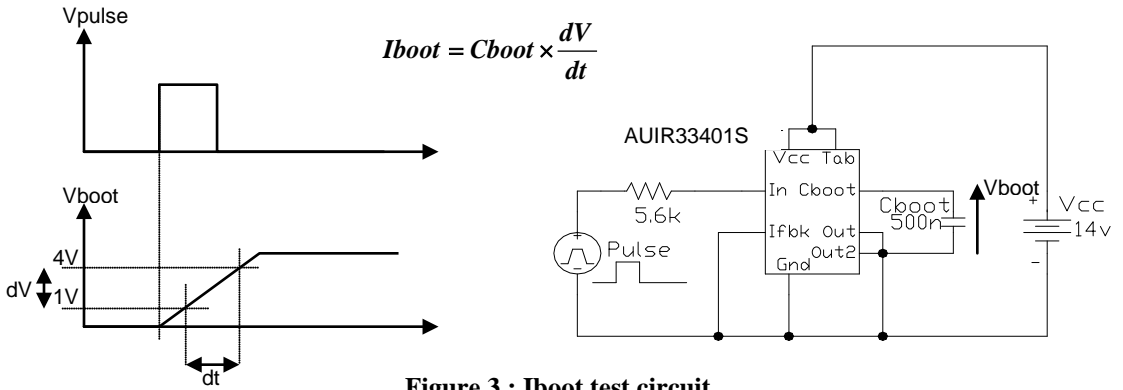
### Current Sense Characteristics

T<sub>j</sub>=25°C (unless otherwise specified), R<sub>fbk</sub>=1kΩ

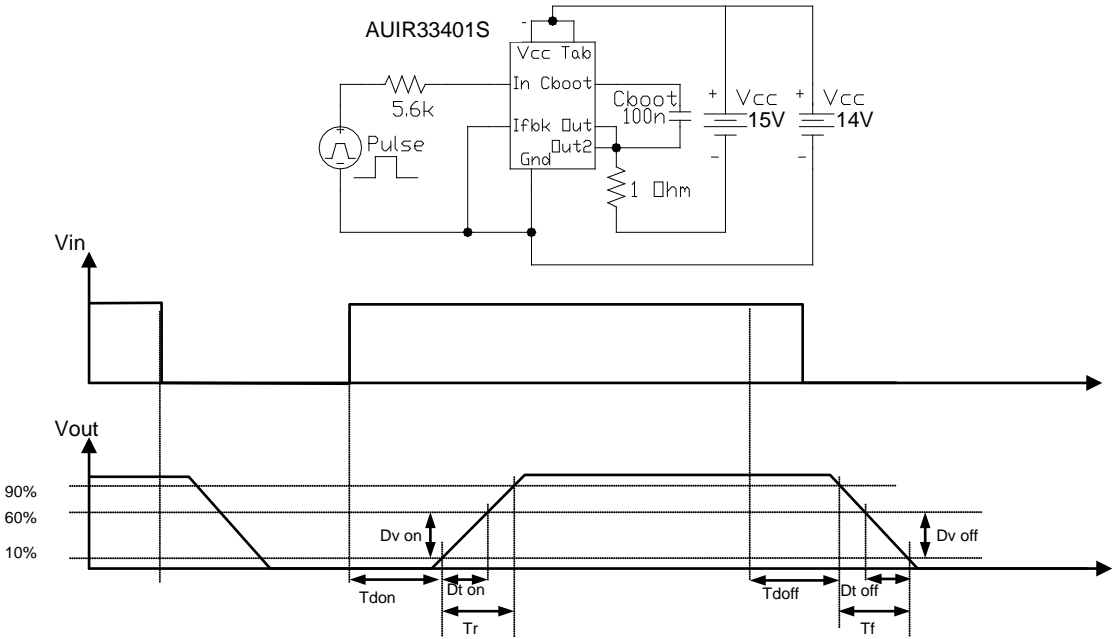
Symbol	Parameter	Min.	Typ.	Max.	Units	Conditions
Offset	Load current diagnostic offset	-3	0.18	3	A	
Ratio	(I <sub>load</sub> - Offset) / I <sub>fb</sub>	5250	6400	7450	—	

### Leads Assignment

PART NUMBER	AUIR33401S
1 : I <sub>fbk</sub> 2 : IN 3 : Gnd 4 : V <sub>cc</sub> (Tab) 5 : C <sub>Boot</sub> 6 : OUT 7 : OUT	 <p>D2Pak 7 leads</p>

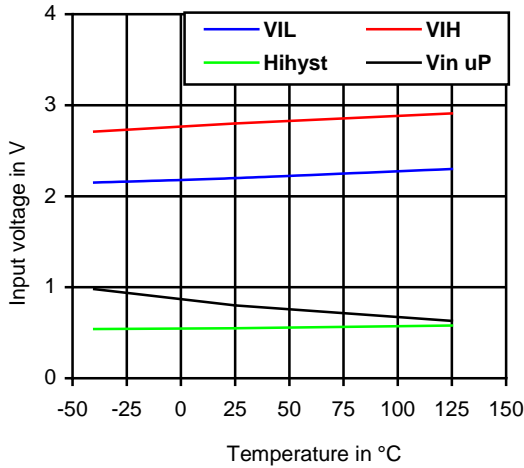
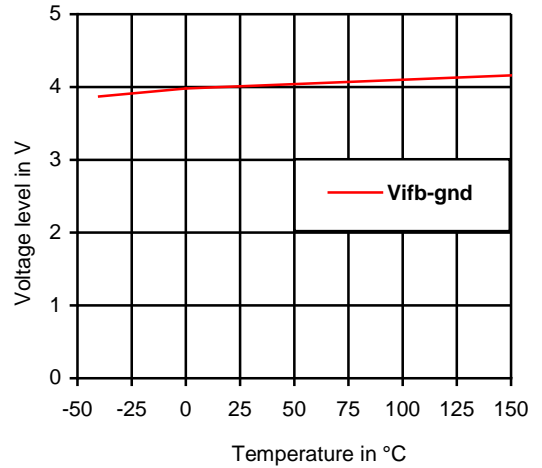
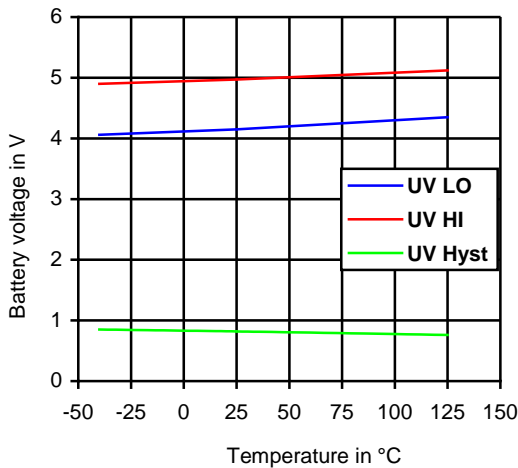
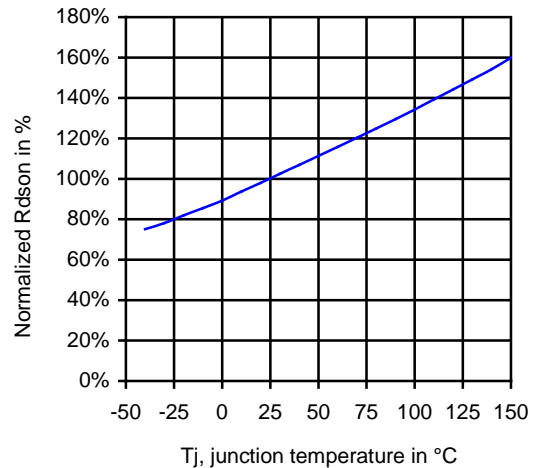


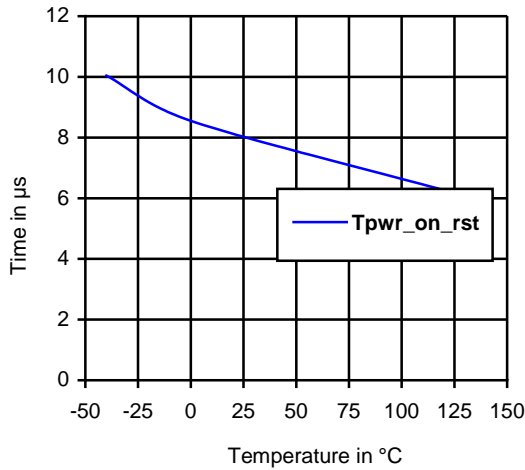
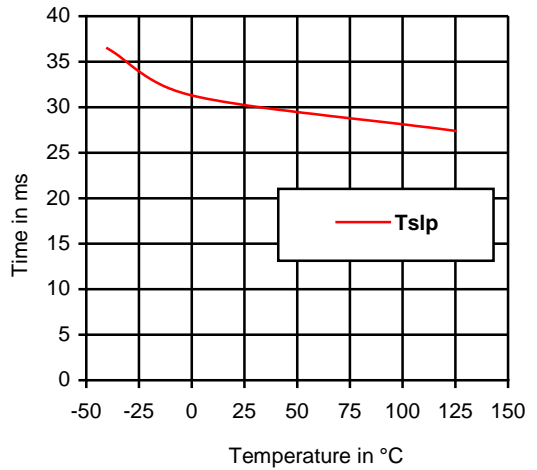
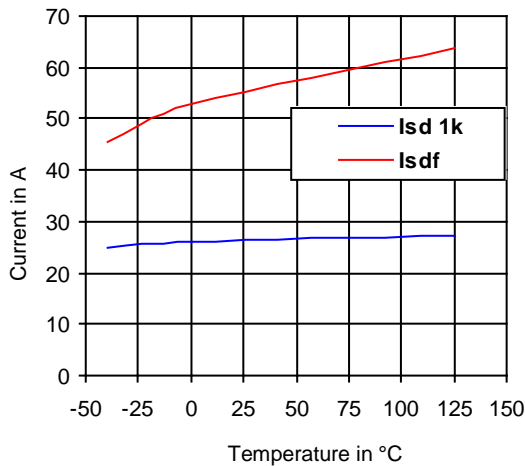
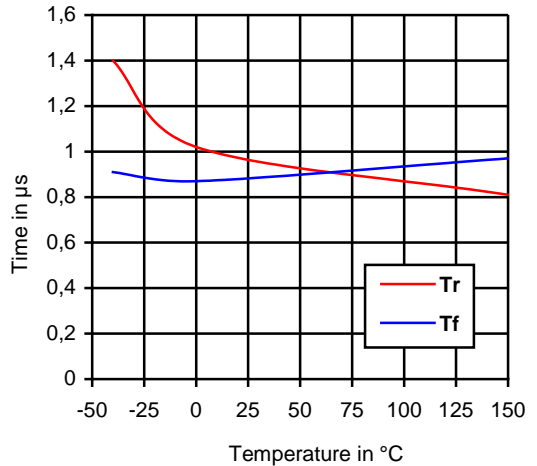
**Figure 3 : Iboot test circuit**

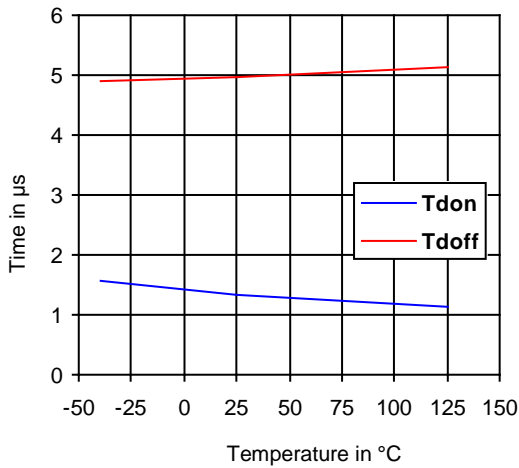
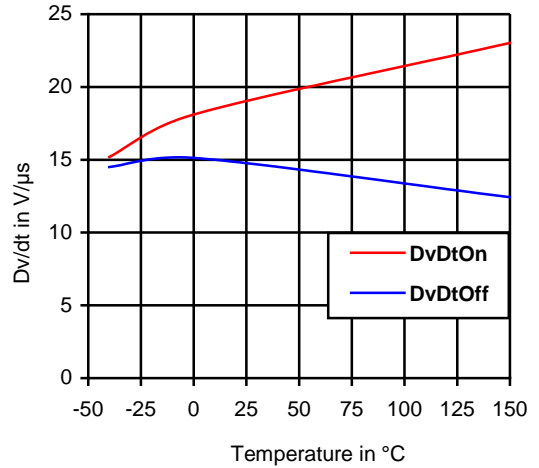
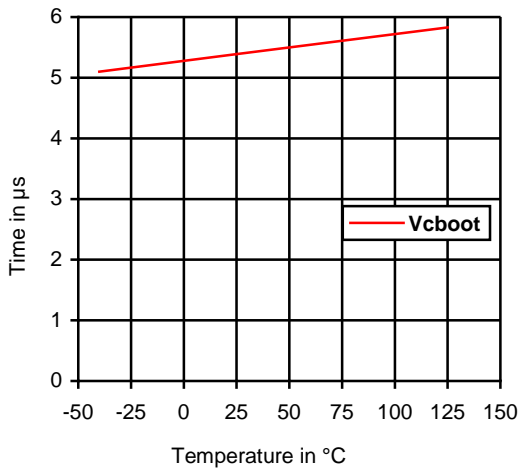
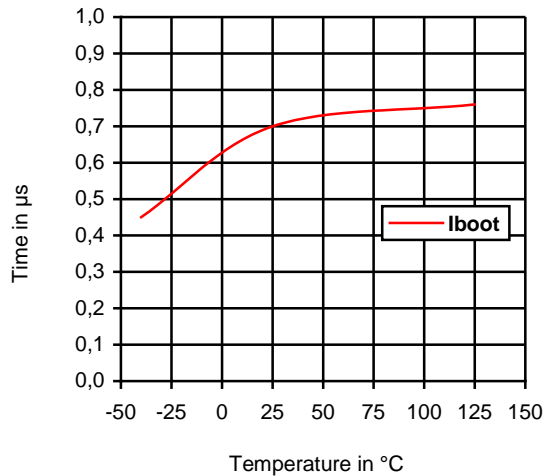


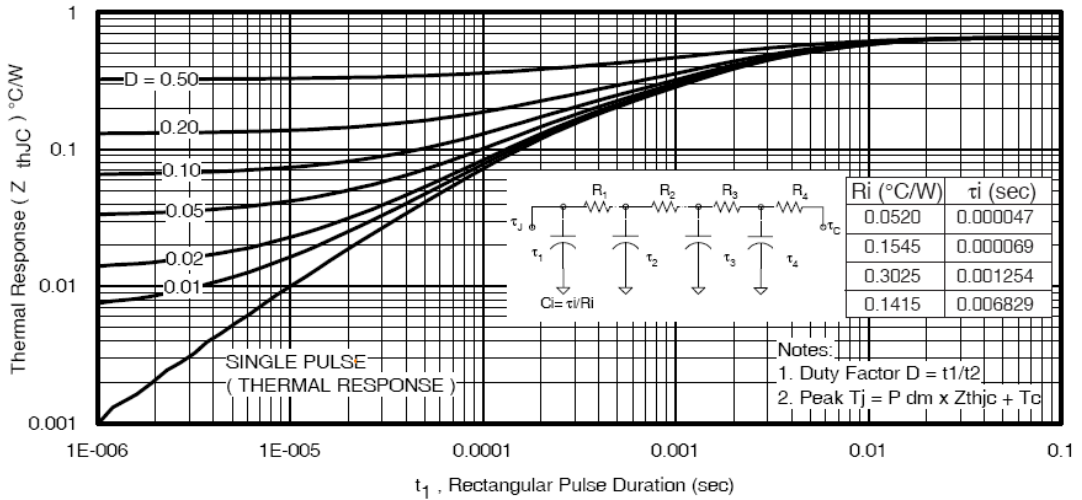
**Figure 4 : Switching time test circuit**




**Figure 5: Input parameters vs. temperature**

**Figure 6: Vifb-gnd vs. temperature**

**Figure 7: Under voltage parameters vs. temperature**

**Figure 8: Normalized Rdson Vs Tj**

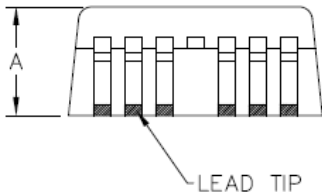
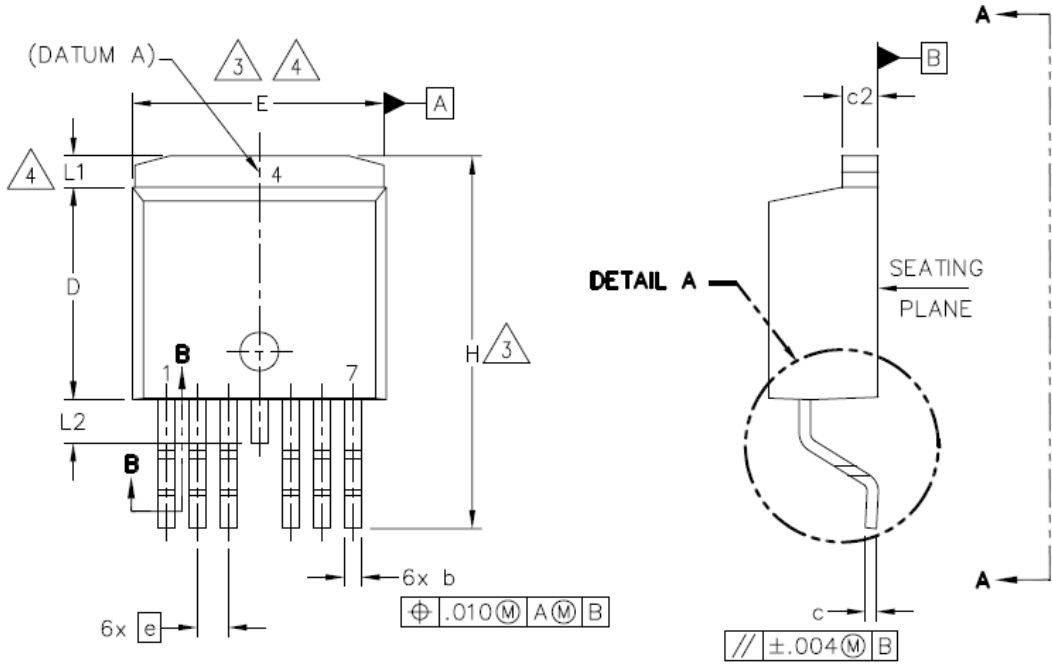

**Figure 9: Tpwr\_on\_rst vs. temperature**

**Figure 10: Tslp vs. temperature**

**Figure 11: Current shutdown vs. temperature**

**Figure 12: Rise and fall time vs. temperature**


**Figure 13: Tdon & off vs. temperature**

**Figure 14: Dv/dt on & off vs. temperature**

**Figure 15: Bootstrap voltage vs. temperature**

**Figure 16: Current bootstrap vs. temperature**



**Figure 17: Transient thermal impedance vs. time**

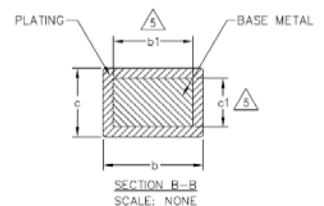
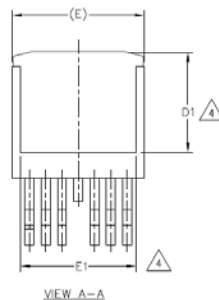
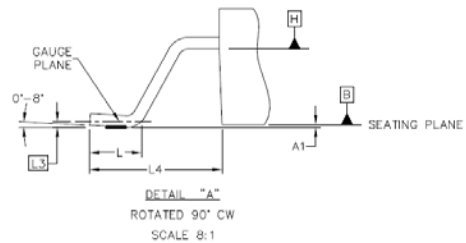
## Case Outline 7L D2PAK



NOTES:

1. DIMENSIONING AND TOLERANCING AS PER ASME Y14.5M-1994
2. DIMENSIONS ARE SHOWN IN MILLIMETERS [INCHES].
3. DIMENSION D & E DO NOT INCLUDE MOLD FLASH. MOLD FLASH SHALL NOT EXCEED 0.127 [.005"] PER SIDE. THESE DIMENSIONS ARE MEASURED AT THE OUTMOST EXTREMES OF THE PLASTIC BODY AT DATUM H.
4. THERMAL PAD CONTOUR OPTIONAL WITHIN DIMENSION E, L1, D1 & E1.
5. DIMENSION b1 AND c1 APPLY TO BASE METAL ONLY.
6. DATUM A & B TO BE DETERMINED AT DATUM PLANE H.
7. CONTROLLING DIMENSION: INCH.
8. OUTLINE CONFORMS TO JEDEC OUTLINE TO-263CB.

SYMBOL	DIMENSIONS				NOTES
	MILLIMETERS		INCHES		
	MIN.	MAX.	MIN.	MAX.	
A	4.06	4.83	.160	.190	
A1	—	0.254	—	.010	
b	0.51	0.99	.020	.036	
b1	0.51	0.89	.020	.032	5
c	0.38	0.74	.015	.029	
c1	0.38	0.58	.015	.023	5
c2	1.14	1.65	.045	.065	
D	8.38	9.65	.330	.380	3
D1	6.86	—	.270	—	4
E	9.65	10.67	.380	.420	3,4
E1	6.22	—	.245	—	4
e	2.54 BSC		.050 BSC		
H	14.61	15.88	.575	.625	
L	1.78	2.79	.070	.110	
L1	—	1.68	—	.066	
L2	—	1.78	—	.070	4
L3	0.25 BSC		.010 BSC		
L4	4.78	5.28	.188	.208	



## IMPORTANT NOTICE

Unless specifically designated for the automotive market, International Rectifier Corporation and its subsidiaries (IR) reserve the right to make corrections, modifications, enhancements, improvements, and other changes to its products and services at any time and to discontinue any product or services without notice. Part numbers designated with the "AU" prefix follow automotive industry and / or customer specific requirements with regards to product discontinuance and process change notification. All products are sold subject to IR's terms and conditions of sale supplied at the time of order acknowledgment.

IR warrants performance of its hardware products to the specifications applicable at the time of sale in accordance with IR's standard warranty. Testing and other quality control techniques are used to the extent IR deems necessary to support this warranty. Except where mandated by government requirements, testing of all parameters of each product is not necessarily performed.

IR assumes no liability for applications assistance or customer product design. Customers are responsible for their products and applications using IR components. To minimize the risks with customer products and applications, customers should provide adequate design and operating safeguards.

Reproduction of IR information in IR data books or data sheets is permissible only if reproduction is without alteration and is accompanied by all associated warranties, conditions, limitations, and notices. Reproduction of this information with alterations is an unfair and deceptive business practice. IR is not responsible or liable for such altered documentation. Information of third parties may be subject to additional restrictions.

Resale of IR products or serviced with statements different from or beyond the parameters stated by IR for that product or service voids all express and any implied warranties for the associated IR product or service and is an unfair and deceptive business practice. IR is not responsible or liable for any such statements.

IR products are not designed, intended, or authorized for use as components in systems intended for surgical implant into the body, or in other applications intended to support or sustain life, or in any other application in which the failure of the IR product could create a situation where personal injury or death may occur. Should Buyer purchase or use IR products for any such unintended or unauthorized application, Buyer shall indemnify and hold International Rectifier and its officers, employees, subsidiaries, affiliates, and distributors harmless against all claims, costs, damages, and expenses, and reasonable attorney fees arising out of, directly or indirectly, any claim of personal injury or death associated with such unintended or unauthorized use, even if such claim alleges that IR was negligent regarding the design or manufacture of the product.

Only products certified as military grade by the Defense Logistics Agency (DLA) of the US Department of Defense, are designed and manufactured to meet DLA military specifications required by certain military, aerospace or other applications. Buyers acknowledge and agree that any use of IR products not certified by DLA as military-grade, in applications requiring military grade products, is solely at the Buyer's own risk and that they are solely responsible for compliance with all legal and regulatory requirements in connection with such use.

IR products are neither designed nor intended for use in automotive applications or environments unless the specific IR products are designated by IR as compliant with ISO/TS 16949 requirements and bear a part number including the designation "AU". Buyers acknowledge and agree that, if they use any non-designated products in automotive applications, IR will not be responsible for any failure to meet such requirements.

For technical support, please contact IR's Technical Assistance Center  
<http://www.irf.com/technical-info/>

### WORLD HEADQUARTERS:

101 N. Sepulveda Blvd., El Segundo, California 90245  
Tel: (310) 252-7105

**Revision History**

Revision	Date	Notes/Changes
A	25/07/08	First release
B	25/09/08	Page 9: <ul style="list-style-type: none"> <li>• Replace the 98-0472 reference into the two drawing by the new reference AUIR33401S</li> <li>• Invert the two battery voltage (14v and 15v) into the figure 4</li> </ul>
C	4 March 2013	<ol style="list-style-type: none"> <li>1) Correct the Iratio formulas in the current sense characteristic table.</li> <li>2) Added Important Notice on last page</li> </ol>

## Looking for pricing, stock, or lifecycle information?

Click below to explore more details on WIN SOURCE:

- ⊖ [View AUIR33401STRL on WIN SOURCE](#)
- ⊖ [Infineon Technologies](#) Information

## Optimize Your Supply Chain with WIN SOURCE Solutions

- ✓ Global Sourcing Solution
- ✓ Obsolete Management
- ✓ Cost Control Management
- ✓ Shortage Management
- ✓ Alternative Solution
- ✓ Excess Inventory Management