

## Features

- High Performance, Low Power AVR<sup>®</sup> 8-Bit Microcontroller
- Advanced RISC Architecture
  - 130 Powerful Instructions – Most Single Clock Cycle Execution
  - 32 x 8 General Purpose Working Registers
  - Fully Static Operation
  - Up to 16 MIPS Throughput at 16 MHz
  - On-Chip 2-cycle Multiplier
- Non-volatile Program and Data Memories
  - 16K bytes of In-System Self-Programmable Flash  
Endurance: 10,000 Write/Erase Cycles
  - Optional Boot Code Section with Independent Lock Bits  
In-System Programming by On-chip Boot Program  
True Read-While-Write Operation
  - 512 bytes EEPROM  
Endurance: 100,000 Write/Erase Cycles
  - 1K byte Internal SRAM
  - Programming Lock for Software Security
- JTAG (IEEE std. 1149.1 compliant) Interface
  - Boundary-scan Capabilities According to the JTAG Standard
  - Extensive On-chip Debug Support
  - Programming of Flash, EEPROM, Fuses, and Lock Bits through the JTAG Interface
- Peripheral Features
  - 4 x 25 Segment LCD Driver
  - Two 8-bit Timer/Counters with Separate Prescaler and Compare Mode
  - One 16-bit Timer/Counter with Separate Prescaler, Compare Mode, and Capture Mode
  - Real Time Counter with Separate Oscillator
  - Four PWM Channels
  - 8-channel, 10-bit ADC
  - Programmable Serial USART
  - Master/Slave SPI Serial Interface
  - Universal Serial Interface with Start Condition Detector
  - Programmable Watchdog Timer with Separate On-chip Oscillator
  - On-chip Analog Comparator
  - Interrupt and Wake-up on Pin Change
- Special Microcontroller Features
  - Power-on Reset and Programmable Brown-out Detection
  - Internal Calibrated Oscillator
  - External and Internal Interrupt Sources
  - Five Sleep Modes: Idle, ADC Noise Reduction, Power-save, Power-down, and Standby
- I/O and Packages
  - 53 Programmable I/O Lines
  - 64-lead TQFP and 64-pad MLF
- Speed Grade:
  - ATmega169V: 0 - 4 MHz @ 1.8 - 5.5V, 0 - 8 MHz @ 2.7 - 5.5V
  - ATmega169: 0 - 8 MHz @ 2.7 - 5.5V, 0 - 16 MHz @ 4.5 - 5.5V
- Temperature range:
  - -40°C to 85°C Industrial
- Ultra-Low Power Consumption
  - Active Mode:
    - 1 MHz, 1.8V: 350µA
    - 32 kHz, 1.8V: 20µA (including Oscillator)
    - 32 kHz, 1.8V: 40µA (including Oscillator and LCD)
  - Power-down Mode:
    - 0.1µA at 1.8V



8-bit AVR<sup>®</sup>  
Microcontroller  
with 16K Bytes  
In-System  
Programmable  
Flash

ATmega169V  
ATmega169

Preliminary  
Summary

2514KS-AVR-05/04



Note: This is a summary document. A complete document is available on our Web site at [www.atmel.com](http://www.atmel.com).

# Pin Configurations

Figure 1. Pinout ATmega169

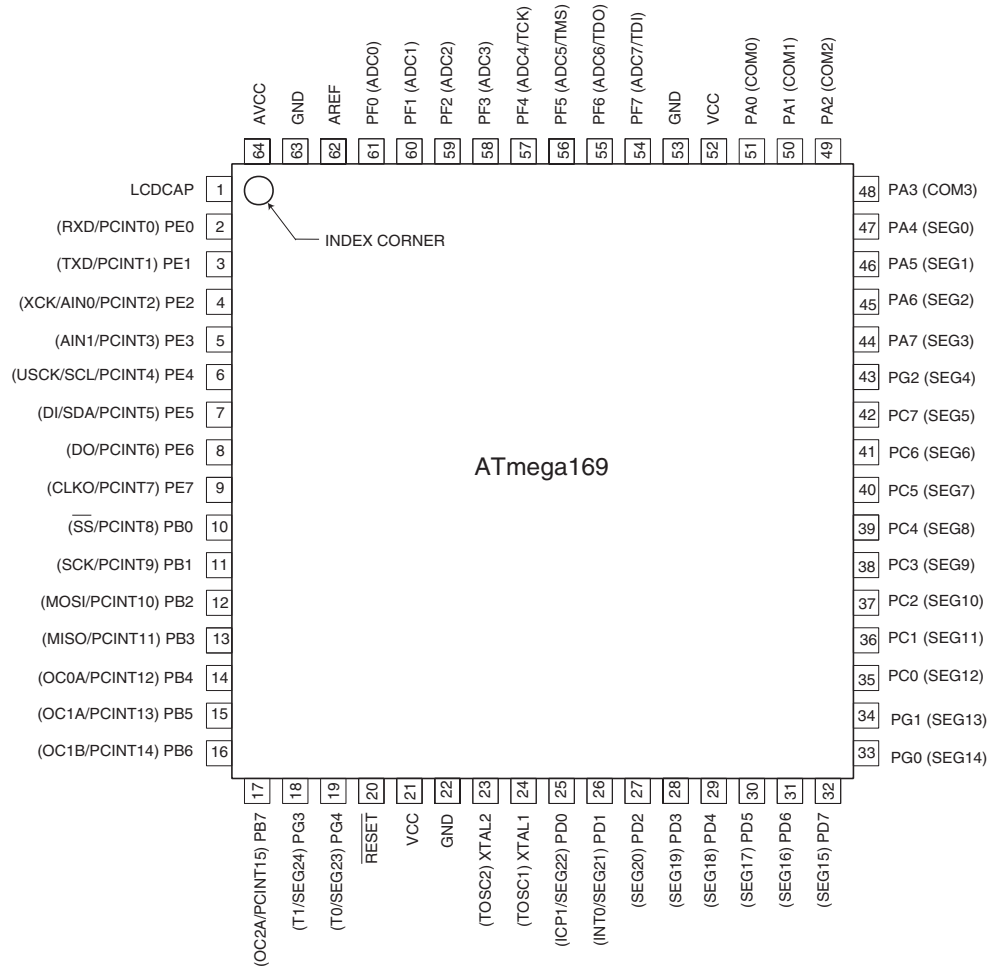

Note: The large center pad underneath the MLF packages is made of metal and internally connected to GND. It should be soldered or glued to the board to ensure good mechanical stability. If the center pad is left unconnected, the package might loosen from the board.

## Disclaimer

Typical values contained in this datasheet are based on simulations and characterization of other AVR microcontrollers manufactured on the same process technology. Min and Max values will be available after the device is characterized.

## Overview

The ATmega169 is a low-power CMOS 8-bit microcontroller based on the AVR enhanced RISC architecture. By executing powerful instructions in a single clock cycle, the ATmega169 achieves throughputs approaching 1 MIPS per MHz allowing the system designer to optimize power consumption versus processing speed.

## Block Diagram

Figure 2. Block Diagram

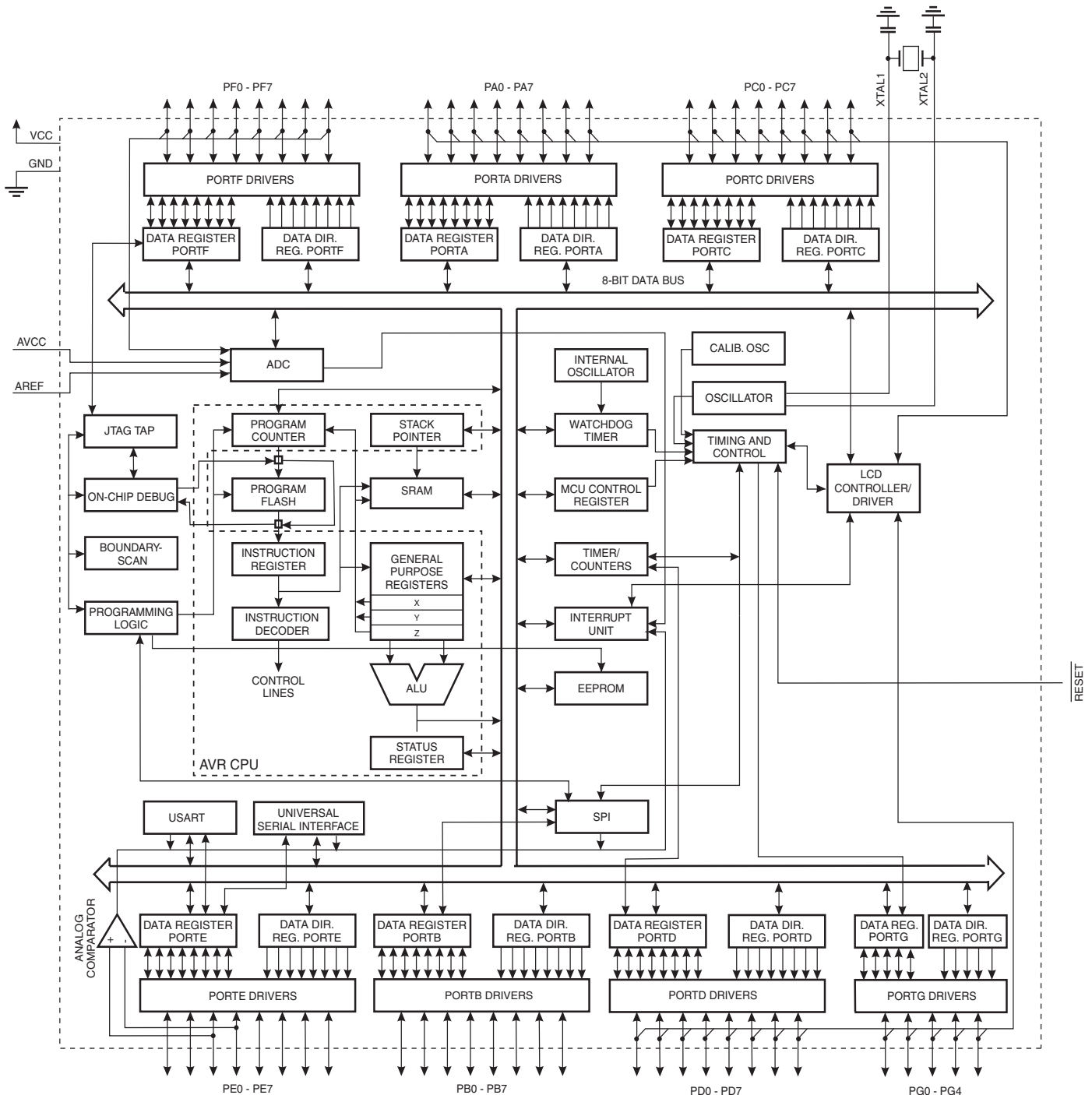



The AVR core combines a rich instruction set with 32 general purpose working registers. All the 32 registers are directly connected to the Arithmetic Logic Unit (ALU), allowing two independent registers to be accessed in one single instruction executed in one clock cycle. The resulting architecture is more code efficient while achieving throughputs up to ten times faster than conventional CISC microcontrollers.

The ATmega169 provides the following features: 16K bytes of In-System Programmable Flash with Read-While-Write capabilities, 512 bytes EEPROM, 1K byte SRAM, 53 general purpose I/O lines, 32 general purpose working registers, a JTAG interface for Boundary-scan, On-chip Debugging support and programming, a complete On-chip LCD controller with internal step-up voltage, three flexible Timer/Counters with compare modes, internal and external interrupts, a serial programmable USART, Universal Serial Interface with Start Condition Detector, an 8-channel, 10-bit ADC, a programmable Watchdog Timer with internal Oscillator, an SPI serial port, and five software selectable power saving modes. The Idle mode stops the CPU while allowing the SRAM, Timer/Counters, SPI port, and interrupt system to continue functioning. The Power-down mode saves the register contents but freezes the Oscillator, disabling all other chip functions until the next interrupt or hardware reset. In Power-save mode, the asynchronous timer and the LCD controller continues to run, allowing the user to maintain a timer base and operate the LCD display while the rest of the device is sleeping. The ADC Noise Reduction mode stops the CPU and all I/O modules except asynchronous timer, LCD controller and ADC, to minimize switching noise during ADC conversions. In Standby mode, the crystal/resonator Oscillator is running while the rest of the device is sleeping. This allows very fast start-up combined with low-power consumption.

The device is manufactured using Atmel's high density non-volatile memory technology. The On-chip ISP Flash allows the program memory to be reprogrammed In-System through an SPI serial interface, by a conventional non-volatile memory programmer, or by an On-chip Boot program running on the AVR core. The Boot program can use any interface to download the application program in the Application Flash memory. Software in the Boot Flash section will continue to run while the Application Flash section is updated, providing true Read-While-Write operation. By combining an 8-bit RISC CPU with In-System Self-Programmable Flash on a monolithic chip, the Atmel ATmega169 is a powerful microcontroller that provides a highly flexible and cost effective solution to many embedded control applications.

The ATmega169 AVR is supported with a full suite of program and system development tools including: C Compilers, Macro Assemblers, Program Debugger/Simulators, In-Circuit Emulators, and Evaluation kits.

## Pin Descriptions

<b>VCC</b>	Digital supply voltage.
<b>GND</b>	Ground.
<b>Port A (PA7..PA0)</b>	<p>Port A is an 8-bit bi-directional I/O port with internal pull-up resistors (selected for each bit). The Port A output buffers have symmetrical drive characteristics with both high sink and source capability. As inputs, Port A pins that are externally pulled low will source current if the pull-up resistors are activated. The Port A pins are tri-stated when a reset condition becomes active, even if the clock is not running.</p> <p>Port A also serves the functions of various special features of the ATmega169 as listed on page 60.</p>
<b>Port B (PB7..PB0)</b>	<p>Port B is an 8-bit bi-directional I/O port with internal pull-up resistors (selected for each bit). The Port B output buffers have symmetrical drive characteristics with both high sink and source capability. As inputs, Port B pins that are externally pulled low will source current if the pull-up resistors are activated. The Port B pins are tri-stated when a reset condition becomes active, even if the clock is not running.</p> <p>Port B has better driving capabilities than the other ports.</p> <p>Port B also serves the functions of various special features of the ATmega169 as listed on page 61.</p>
<b>Port C (PC7..PC0)</b>	<p>Port C is an 8-bit bi-directional I/O port with internal pull-up resistors (selected for each bit). The Port C output buffers have symmetrical drive characteristics with both high sink and source capability. As inputs, Port C pins that are externally pulled low will source current if the pull-up resistors are activated. The Port C pins are tri-stated when a reset condition becomes active, even if the clock is not running.</p> <p>Port C also serves the functions of special features of the ATmega169 as listed on page 64.</p>
<b>Port D (PD7..PD0)</b>	<p>Port D is an 8-bit bi-directional I/O port with internal pull-up resistors (selected for each bit). The Port D output buffers have symmetrical drive characteristics with both high sink and source capability. As inputs, Port D pins that are externally pulled low will source current if the pull-up resistors are activated. The Port D pins are tri-stated when a reset condition becomes active, even if the clock is not running.</p> <p>Port D also serves the functions of various special features of the ATmega169 as listed on page 66.</p>
<b>Port E (PE7..PE0)</b>	<p>Port E is an 8-bit bi-directional I/O port with internal pull-up resistors (selected for each bit). The Port E output buffers have symmetrical drive characteristics with both high sink and source capability. As inputs, Port E pins that are externally pulled low will source current if the pull-up resistors are activated. The Port E pins are tri-stated when a reset condition becomes active, even if the clock is not running.</p> <p>Port E also serves the functions of various special features of the ATmega169 as listed on page 68.</p>
<b>Port F (PF7..PF0)</b>	<p>Port F serves as the analog inputs to the A/D Converter.</p> <p>Port F also serves as an 8-bit bi-directional I/O port, if the A/D Converter is not used. Port pins can provide internal pull-up resistors (selected for each bit). The Port F output</p>

buffers have symmetrical drive characteristics with both high sink and source capability. As inputs, Port F pins that are externally pulled low will source current if the pull-up resistors are activated. The Port F pins are tri-stated when a reset condition becomes active, even if the clock is not running. If the JTAG interface is enabled, the pull-up resistors on pins PF7(TDI), PF5(TMS), and PF4(TCK) will be activated even if a reset occurs.

Port F also serves the functions of the JTAG interface.

#### **Port G (PG4..PG0)**

Port G is a 5-bit bi-directional I/O port with internal pull-up resistors (selected for each bit). The Port G output buffers have symmetrical drive characteristics with both high sink and source capability. As inputs, Port G pins that are externally pulled low will source current if the pull-up resistors are activated. The Port G pins are tri-stated when a reset condition becomes active, even if the clock is not running.

Port G also serves the functions of various special features of the ATmega169 as listed on page 68.

#### **$\overline{\text{RESET}}$**

Reset input. A low level on this pin for longer than the minimum pulse length will generate a reset, even if the clock is not running. The minimum pulse length is given in Table 16 on page 38. Shorter pulses are not guaranteed to generate a reset.

#### **XTAL1**

Input to the inverting Oscillator amplifier and input to the internal clock operating circuit.

#### **XTAL2**

Output from the inverting Oscillator amplifier.

#### **AVCC**

AVCC is the supply voltage pin for Port F and the A/D Converter. It should be externally connected to  $V_{CC}$ , even if the ADC is not used. If the ADC is used, it should be connected to  $V_{CC}$  through a low-pass filter.

#### **AREF**

This is the analog reference pin for the A/D Converter.

#### **LCDCAP**

An external capacitor (typical > 470 nF) must be connected to the LCDCAP pin as shown in Figure 97. This capacitor acts as a reservoir for LCD power ( $V_{LCD}$ ). A large capacitance reduces ripple on  $V_{LCD}$  but increases the time until  $V_{LCD}$  reaches its target value.

Register Summary

Address	Name	Bit 7	Bit 6	Bit 5	Bit 4	Bit 3	Bit 2	Bit 1	Bit 0	Page
(0xFF)	Reserved	–	–	–	–	–	–	–	–	
(0xFE)	LCDDR18	–	–	–	–	–	–	–	SEG324	227
(0xFD)	LCDDR17	SEG323	SEG322	SEG321	SEG320	SEG319	SEG318	SEG317	SEG316	227
(0xFC)	LCDDR16	SEG315	SEG314	SEG313	SEG312	SEG311	SEG310	SEG309	SEG308	227
(0xFB)	LCDDR15	SEG307	SEG306	SEG305	SEG304	SEG303	SEG302	SEG301	SEG300	227
(0xFA)	Reserved	–	–	–	–	–	–	–	–	
(0xF9)	LCDDR13	–	–	–	–	–	–	–	SEG224	227
(0xF8)	LCDDR12	SEG223	SEG222	SEG221	SEG220	SEG219	SEG218	SEG217	SEG216	227
(0xF7)	LCDDR11	SEG215	SEG214	SEG213	SEG212	SEG211	SEG210	SEG209	SEG208	227
(0xF6)	LCDDR10	SEG207	SEG206	SEG205	SEG204	SEG203	SEG202	SEG201	SEG200	227
(0xF5)	Reserved	–	–	–	–	–	–	–	–	
(0xF4)	LCDDR8	–	–	–	–	–	–	–	SEG124	227
(0xF3)	LCDDR7	SEG123	SEG122	SEG121	SEG120	SEG119	SEG118	SEG117	SEG116	227
(0xF2)	LCDDR6	SEG115	SEG114	SEG113	SEG112	SEG111	SEG110	SEG109	SEG108	227
(0xF1)	LCDDR5	SEG107	SEG106	SEG105	SEG104	SEG103	SEG102	SEG101	SEG100	227
(0xF0)	Reserved	–	–	–	–	–	–	–	–	
(0xEF)	LCDDR3	–	–	–	–	–	–	–	SEG024	227
(0xEE)	LCDDR2	SEG023	SEG022	SEG021	SEG020	SEG019	SEG018	SEG017	SEG016	227
(0xED)	LCDDR1	SEG015	SEG014	SEG013	SEG012	SEG011	SEG010	SEG009	SEG008	227
(0xEC)	LCDDR0	SEG007	SEG006	SEG005	SEG004	SEG003	SEG002	SEG001	SEG000	227
(0xEB)	Reserved	–	–	–	–	–	–	–	–	
(0xEA)	Reserved	–	–	–	–	–	–	–	–	
(0xE9)	Reserved	–	–	–	–	–	–	–	–	
(0xE8)	Reserved	–	–	–	–	–	–	–	–	
(0xE7)	LCDCR	LCDCD2	LCDCD1	LCDC0	–	LCDC3	LCDC2	LCDC1	LCDC0	225
(0xE6)	LCDFRR	–	LCDPS2	LCDPS1	LCDPS0	–	LCDCD2	LCDCD1	LCDCD0	223
(0xE5)	LCDCRB	LCDCS	LCDB2B	LCDMUX1	LCDMUX0	–	LCDCD2	LCDCD1	LCDCD0	222
(0xE4)	LCDCRA	LCDEN	LCDAB	–	LCDIF	LCDIE	–	–	LCDBL	221
(0xE3)	Reserved	–	–	–	–	–	–	–	–	
(0xE2)	Reserved	–	–	–	–	–	–	–	–	
(0xE1)	Reserved	–	–	–	–	–	–	–	–	
(0xE0)	Reserved	–	–	–	–	–	–	–	–	
(0xDF)	Reserved	–	–	–	–	–	–	–	–	
(0xDE)	Reserved	–	–	–	–	–	–	–	–	
(0xDD)	Reserved	–	–	–	–	–	–	–	–	
(0xDC)	Reserved	–	–	–	–	–	–	–	–	
(0xDB)	Reserved	–	–	–	–	–	–	–	–	
(0xDA)	Reserved	–	–	–	–	–	–	–	–	
(0xD9)	Reserved	–	–	–	–	–	–	–	–	
(0xD8)	Reserved	–	–	–	–	–	–	–	–	
(0xD7)	Reserved	–	–	–	–	–	–	–	–	
(0xD6)	Reserved	–	–	–	–	–	–	–	–	
(0xD5)	Reserved	–	–	–	–	–	–	–	–	
(0xD4)	Reserved	–	–	–	–	–	–	–	–	
(0xD3)	Reserved	–	–	–	–	–	–	–	–	
(0xD2)	Reserved	–	–	–	–	–	–	–	–	
(0xD1)	Reserved	–	–	–	–	–	–	–	–	
(0xD0)	Reserved	–	–	–	–	–	–	–	–	
(0xCF)	Reserved	–	–	–	–	–	–	–	–	
(0xCE)	Reserved	–	–	–	–	–	–	–	–	
(0xCD)	Reserved	–	–	–	–	–	–	–	–	
(0xCC)	Reserved	–	–	–	–	–	–	–	–	
(0xCB)	Reserved	–	–	–	–	–	–	–	–	
(0xCA)	Reserved	–	–	–	–	–	–	–	–	
(0xC9)	Reserved	–	–	–	–	–	–	–	–	
(0xC8)	Reserved	–	–	–	–	–	–	–	–	
(0xC7)	Reserved	–	–	–	–	–	–	–	–	
(0xC6)	UDR	USART I/O Data Register								171
(0xC5)	UBRRH	USART Baud Rate Register High								175
(0xC4)	UBRRL	USART Baud Rate Register Low								175
(0xC3)	Reserved	–	–	–	–	–	–	–	–	
(0xC2)	UCSRC	–	UMSEL	UPM1	UPM0	USBS	UCSZ1	UCSZ0	UCPOL	171
(0xC1)	UCSRB	RXCIE	TXCIE	UDRIE	RXEN	TXEN	UCSZ2	RXB8	TXB8	171
(0xC0)	UCSRA	RXC	TXC	UDRE	FE	DOR	UPE	U2X	MPCM	171





Address	Name	Bit 7	Bit 6	Bit 5	Bit 4	Bit 3	Bit 2	Bit 1	Bit 0	Page
(0xBF)	Reserved	–	–	–	–	–	–	–	–	
(0xBE)	Reserved	–	–	–	–	–	–	–	–	
(0xBD)	Reserved	–	–	–	–	–	–	–	–	
(0xBC)	Reserved	–	–	–	–	–	–	–	–	
(0xBB)	Reserved	–	–	–	–	–	–	–	–	
(0xBA)	USIDR	USI Data Register								186
(0xB9)	USISR	USISIF	USIOIF	USIPF	USIDC	USICNT3	USICNT2	USICNT1	USICNT0	187
(0xB8)	USICR	USISIE	USIOIE	USIWM1	USIWM0	USICS1	USICS0	USICLK	USITC	188
(0xB7)	Reserved	–	–	–	–	–	–	–	–	
(0xB6)	ASSR	–	–	–	EXCLK	AS2	TCN2UB	OCR2UB	TCR2UB	139
(0xB5)	Reserved	–	–	–	–	–	–	–	–	
(0xB4)	Reserved	–	–	–	–	–	–	–	–	
(0xB3)	OCR2A	Timer/Counter2 Output Compare Register A								138
(0xB2)	TCNT2	Timer/Counter2 (8-bit)								138
(0xB1)	Reserved	–	–	–	–	–	–	–	–	
(0xB0)	TCCR2A	FOC2A	WGM20	COM2A1	COM2A0	WGM21	CS22	CS21	CS20	136
(0xAF)	Reserved	–	–	–	–	–	–	–	–	
(0xAE)	Reserved	–	–	–	–	–	–	–	–	
(0xAD)	Reserved	–	–	–	–	–	–	–	–	
(0xAC)	Reserved	–	–	–	–	–	–	–	–	
(0xAB)	Reserved	–	–	–	–	–	–	–	–	
(0xAA)	Reserved	–	–	–	–	–	–	–	–	
(0xA9)	Reserved	–	–	–	–	–	–	–	–	
(0xA8)	Reserved	–	–	–	–	–	–	–	–	
(0xA7)	Reserved	–	–	–	–	–	–	–	–	
(0xA6)	Reserved	–	–	–	–	–	–	–	–	
(0xA5)	Reserved	–	–	–	–	–	–	–	–	
(0xA4)	Reserved	–	–	–	–	–	–	–	–	
(0xA3)	Reserved	–	–	–	–	–	–	–	–	
(0xA2)	Reserved	–	–	–	–	–	–	–	–	
(0xA1)	Reserved	–	–	–	–	–	–	–	–	
(0xA0)	Reserved	–	–	–	–	–	–	–	–	
(0x9F)	Reserved	–	–	–	–	–	–	–	–	
(0x9E)	Reserved	–	–	–	–	–	–	–	–	
(0x9D)	Reserved	–	–	–	–	–	–	–	–	
(0x9C)	Reserved	–	–	–	–	–	–	–	–	
(0x9B)	Reserved	–	–	–	–	–	–	–	–	
(0x9A)	Reserved	–	–	–	–	–	–	–	–	
(0x99)	Reserved	–	–	–	–	–	–	–	–	
(0x98)	Reserved	–	–	–	–	–	–	–	–	
(0x97)	Reserved	–	–	–	–	–	–	–	–	
(0x96)	Reserved	–	–	–	–	–	–	–	–	
(0x95)	Reserved	–	–	–	–	–	–	–	–	
(0x94)	Reserved	–	–	–	–	–	–	–	–	
(0x93)	Reserved	–	–	–	–	–	–	–	–	
(0x92)	Reserved	–	–	–	–	–	–	–	–	
(0x91)	Reserved	–	–	–	–	–	–	–	–	
(0x90)	Reserved	–	–	–	–	–	–	–	–	
(0x8F)	Reserved	–	–	–	–	–	–	–	–	
(0x8E)	Reserved	–	–	–	–	–	–	–	–	
(0x8D)	Reserved	–	–	–	–	–	–	–	–	
(0x8C)	Reserved	–	–	–	–	–	–	–	–	
(0x8B)	OCR1BH	Timer/Counter1 - Output Compare Register B High Byte								122
(0x8A)	OCR1BL	Timer/Counter1 - Output Compare Register B Low Byte								122
(0x89)	OCR1AH	Timer/Counter1 - Output Compare Register A High Byte								122
(0x88)	OCR1AL	Timer/Counter1 - Output Compare Register A Low Byte								122
(0x87)	ICR1H	Timer/Counter1 - Input Capture Register High Byte								123
(0x86)	ICR1L	Timer/Counter1 - Input Capture Register Low Byte								123
(0x85)	TCNT1H	Timer/Counter1 - Counter Register High Byte								122
(0x84)	TCNT1L	Timer/Counter1 - Counter Register Low Byte								122
(0x83)	Reserved	–	–	–	–	–	–	–	–	
(0x82)	TCCR1C	FOC1A	FOC1B	–	–	–	–	–	–	121
(0x81)	TCCR1B	ICNC1	ICES1	–	WGM13	WGM12	CS12	CS11	CS10	120
(0x80)	TCCR1A	COM1A1	COM1A0	COM1B1	COM1B0	–	–	WGM11	WGM10	118
(0x7F)	DIDR1	–	–	–	–	–	–	AIN1D	AIN0D	193
(0x7E)	DIDR0	ADC7D	ADC6D	ADC5D	ADC4D	ADC3D	ADC2D	ADC1D	ADC0D	211

Address	Name	Bit 7	Bit 6	Bit 5	Bit 4	Bit 3	Bit 2	Bit 1	Bit 0	Page
(0x7D)	Reserved	–	–	–	–	–	–	–	–	
(0x7C)	ADMUX	REFS1	REFS0	ADLAR	MUX4	MUX3	MUX2	MUX1	MUX0	207
(0x7B)	ADCSRB	–	ACME	–	–	–	ADTS2	ADTS1	ADTS0	191, 211
(0x7A)	ADCSRA	ADEN	ADSC	ADATE	ADIF	ADIE	ADPS2	ADPS1	ADPS0	209
(0x79)	ADCH	ADC Data Register High byte								210
(0x78)	ADCL	ADC Data Register Low byte								210
(0x77)	Reserved	–	–	–	–	–	–	–	–	
(0x76)	Reserved	–	–	–	–	–	–	–	–	
(0x75)	Reserved	–	–	–	–	–	–	–	–	
(0x74)	Reserved	–	–	–	–	–	–	–	–	
(0x73)	Reserved	–	–	–	–	–	–	–	–	
(0x72)	Reserved	–	–	–	–	–	–	–	–	
(0x71)	Reserved	–	–	–	–	–	–	–	–	
(0x70)	TIMSK2	–	–	–	–	–	–	OCIE2A	TOIE2	141
(0x6F)	TIMSK1	–	–	ICIE1	–	–	OCIE1B	OCIE1A	TOIE1	123
(0x6E)	TIMSK0	–	–	–	–	–	–	OCIE0A	TOIE0	93
(0x6D)	Reserved	–	–	–	–	–	–	–	–	
(0x6C)	PCMSK1	PCINT15	PCINT14	PCINT13	PCINT12	PCINT11	PCINT10	PCINT9	PCINT8	79
(0x6B)	PCMSK0	PCINT7	PCINT6	PCINT5	PCINT4	PCINT3	PCINT2	PCINT1	PCINT0	79
(0x6A)	Reserved	–	–	–	–	–	–	–	–	
(0x69)	EICRA	–	–	–	–	–	–	ISC01	ISC00	77
(0x68)	Reserved	–	–	–	–	–	–	–	–	
(0x67)	Reserved	–	–	–	–	–	–	–	–	
(0x66)	OSCCAL	Oscillator Calibration Register								28
(0x65)	Reserved	–	–	–	–	–	–	–	–	
(0x64)	PRR	–	–	–	PRLCD	PRTIM1	PRSPI	PRUSART0	PRADC	34
(0x63)	Reserved	–	–	–	–	–	–	–	–	
(0x62)	Reserved	–	–	–	–	–	–	–	–	
(0x61)	CLKPR	CLKPCE	–	–	–	CLKPS3	CLKPS2	CLKPS1	CLKPS0	29
(0x60)	WDTCR	–	–	–	WDCE	WDE	WDP2	WDP1	WDP0	43
0x3F (0x5F)	SREG	I	T	H	S	V	N	Z	C	9
0x3E (0x5E)	SPH	–	–	–	–	–	SP10	SP9	SP8	11
0x3D (0x5D)	SPL	SP7	SP6	SP5	SP4	SP3	SP2	SP1	SP0	11
0x3C (0x5C)	Reserved									
0x3B (0x5B)	Reserved									
0x3A (0x5A)	Reserved									
0x39 (0x59)	Reserved									
0x38 (0x58)	Reserved									
0x37 (0x57)	SPMCSR	SPMIE	RWWWSB	–	RWWWSRE	BLBSET	PGWRT	PGERS	SPMEN	259
0x36 (0x56)	Reserved	–	–	–	–	–	–	–	–	
0x35 (0x55)	MCUCR	JTD	–	–	PUD	–	–	IVSEL	IVCE	237
0x34 (0x54)	MCUSR	–	–	–	JTRF	WDRF	BORF	EXTRF	PORF	238
0x33 (0x53)	SMCR	–	–	–	–	SM2	SM1	SM0	SE	32
0x32 (0x52)	Reserved	–	–	–	–	–	–	–	–	
0x31 (0x51)	OCDR	IDRD/ OCD	OCDR6	OCDR5	OCDR4	OCDR3	OCDR2	OCDR1	OCDR0	233
0x30 (0x50)	ACSR	ACD	ACBG	ACO	ACI	ACIE	ACIC	ACIS1	ACIS0	191
0x2F (0x4F)	Reserved	–	–	–	–	–	–	–	–	
0x2E (0x4E)	SPDR	SPI Data Register								151
0x2D (0x4D)	SPSR	SPIF	WCOL	–	–	–	–	–	SPI2X	151
0x2C (0x4C)	SPCR	SPIE	SPE	DORD	MSTR	CPOL	CPHA	SPR1	SPR0	149
0x2B (0x4B)	GPOR2	General Purpose I/O Register 2								22
0x2A (0x4A)	GPOR1	General Purpose I/O Register 1								22
0x29 (0x49)	Reserved	–	–	–	–	–	–	–	–	
0x28 (0x48)	Reserved	–	–	–	–	–	–	–	–	
0x27 (0x47)	OCR0A	Timer/Counter0 Output Compare Register A								93
0x26 (0x46)	TCNT0	Timer/Counter0 (8 Bit)								92
0x25 (0x45)	Reserved	–	–	–	–	–	–	–	–	
0x24 (0x44)	TCCR0A	FOC0A	WGM00	COM0A1	COM0A0	WGM01	CS02	CS01	CS00	90
0x23 (0x43)	GTCCR	TSM	–	–	–	–	–	PSR2	PSR10	95
0x22 (0x42)	EEARH	–	–	–	–	–	–	–	EEAR8	18
0x21 (0x41)	EEARL	EEPROM Address Register Low Byte								18
0x20 (0x40)	EEDR	EEPROM Data Register								18
0x1F (0x3F)	EECR	–	–	–	–	EERIE	EEMWE	EERE	EERE	18
0x1E (0x3E)	GPOR0	General Purpose I/O Register 0								22
0x1D (0x3D)	EIMSK	PCIE1	PCIE0	–	–	–	–	–	INT0	78
0x1C (0x3C)	EIFR	PCIF1	PCIF0	–	–	–	–	–	INTF0	78





Address	Name	Bit 7	Bit 6	Bit 5	Bit 4	Bit 3	Bit 2	Bit 1	Bit 0	Page
0x1B (0x3B)	Reserved	–	–	–	–	–	–	–	–	
0x1A (0x3A)	Reserved	–	–	–	–	–	–	–	–	
0x19 (0x39)	Reserved	–	–	–	–	–	–	–	–	
0x18 (0x38)	Reserved	–	–	–	–	–	–	–	–	
0x17 (0x37)	TIFR2	–	–	–	–	–	–	OCF2A	TOV2	142
0x16 (0x36)	TIFR1	–	–	ICF1	–	–	OCF1B	OCF1A	TOV1	124
0x15 (0x35)	TIFR0	–	–	–	–	–	–	OCF0A	TOV0	93
0x14 (0x34)	PORTG	–	–	–	PORTG4	PORTG3	PORTG2	PORTG1	PORTG0	76
0x13 (0x33)	DDRG	–	–	–	DDG4	DDG3	DDG2	DDG1	DDG0	76
0x12 (0x32)	PING	–	–	PING5	PING4	PING3	PING2	PING1	PING0	76
0x11 (0x31)	PORTF	PORTF7	PORTF6	PORTF5	PORTF4	PORTF3	PORTF2	PORTF1	PORTF0	75
0x10 (0x30)	DDRF	DDF7	DDF6	DDF5	DDF4	DDF3	DDF2	DDF1	DDF0	75
0x0F (0x2F)	PINF	PINF7	PINF6	PINF5	PINF4	PINF3	PINF2	PINF1	PINF0	76
0x0E (0x2E)	PORTE	PORTE7	PORTE6	PORTE5	PORTE4	PORTE3	PORTE2	PORTE1	PORTE0	75
0x0D (0x2D)	DDRE	DDE7	DDE6	DDE5	DDE4	DDE3	DDE2	DDE1	DDE0	75
0x0C (0x2C)	PINE	PINE7	PINE6	PINE5	PINE4	PINE3	PINE2	PINE1	PINE0	75
0x0B (0x2B)	PORTD	PORTD7	PORTD6	PORTD5	PORTD4	PORTD3	PORTD2	PORTD1	PORTD0	75
0x0A (0x2A)	DDRD	DDD7	DDD6	DDD5	DDD4	DDD3	DDD2	DDD1	DDD0	75
0x09 (0x29)	PIND	PIND7	PIND6	PIND5	PIND4	PIND3	PIND2	PIND1	PIND0	75
0x08 (0x28)	PORTC	PORTC7	PORTC6	PORTC5	PORTC4	PORTC3	PORTC2	PORTC1	PORTC0	74
0x07 (0x27)	DDRC	DDC7	DDC6	DDC5	DDC4	DDC3	DDC2	DDC1	DDC0	74
0x06 (0x26)	PINC	PINC7	PINC6	PINC5	PINC4	PINC3	PINC2	PINC1	PINC0	75
0x05 (0x25)	PORTB	PORTB7	PORTB6	PORTB5	PORTB4	PORTB3	PORTB2	PORTB1	PORTB0	74
0x04 (0x24)	DDRB	DDB7	DDB6	DDB5	DDB4	DDB3	DDB2	DDB1	DDB0	74
0x03 (0x23)	PINB	PINB7	PINB6	PINB5	PINB4	PINB3	PINB2	PINB1	PINB0	74
0x02 (0x22)	PORTA	PORTA7	PORTA6	PORTA5	PORTA4	PORTA3	PORTA2	PORTA1	PORTA0	74
0x01 (0x21)	DDRA	DDA7	DDA6	DDA5	DDA4	DDA3	DDA2	DDA1	DDA0	74
0x00 (0x20)	PINA	PINA7	PINA6	PINA5	PINA4	PINA3	PINA2	PINA1	PINA0	74

- Note:
1. For compatibility with future devices, reserved bits should be written to zero if accessed. Reserved I/O memory addresses should never be written.
  2. I/O Registers within the address range 0x00 - 0x1F are directly bit-accessible using the SBI and CBI instructions. In these registers, the value of single bits can be checked by using the SBIS and SBIC instructions.
  3. Some of the Status Flags are cleared by writing a logical one to them. Note that, unlike most other AVRs, the CBI and SBI instructions will only operate on the specified bit, and can therefore be used on registers containing such Status Flags. The CBI and SBI instructions work with registers 0x00 to 0x1F only.
  4. When using the I/O specific commands IN and OUT, the I/O addresses 0x00 - 0x3F must be used. When addressing I/O Registers as data space using LD and ST instructions, 0x20 must be added to these addresses. The ATmega169 is a complex microcontroller with more peripheral units than can be supported within the 64 location reserved in Opcode for the IN and OUT instructions. For the Extended I/O space from 0x60 - 0xFF in SRAM, only the ST/STS/STD and LD/LDS/LDD instructions can be used.

## Instruction Set Summary

Mnemonics	Operands	Description	Operation	Flags	#Clocks
<b>ARITHMETIC AND LOGIC INSTRUCTIONS</b>					
ADD	Rd, Rr	Add two Registers	$Rd \leftarrow Rd + Rr$	Z,C,N,V,H	1
ADC	Rd, Rr	Add with Carry two Registers	$Rd \leftarrow Rd + Rr + C$	Z,C,N,V,H	1
ADIW	RdI,K	Add Immediate to Word	$Rdh:Rdl \leftarrow Rdh:Rdl + K$	Z,C,N,V,S	2
SUB	Rd, Rr	Subtract two Registers	$Rd \leftarrow Rd - Rr$	Z,C,N,V,H	1
SUBI	Rd, K	Subtract Constant from Register	$Rd \leftarrow Rd - K$	Z,C,N,V,H	1
SBC	Rd, Rr	Subtract with Carry two Registers	$Rd \leftarrow Rd - Rr - C$	Z,C,N,V,H	1
SBCI	Rd, K	Subtract with Carry Constant from Reg.	$Rd \leftarrow Rd - K - C$	Z,C,N,V,H	1
SBIW	RdI,K	Subtract Immediate from Word	$Rdh:Rdl \leftarrow Rdh:Rdl - K$	Z,C,N,V,S	2
AND	Rd, Rr	Logical AND Registers	$Rd \leftarrow Rd \bullet Rr$	Z,N,V	1
ANDI	Rd, K	Logical AND Register and Constant	$Rd \leftarrow Rd \bullet K$	Z,N,V	1
OR	Rd, Rr	Logical OR Registers	$Rd \leftarrow Rd \vee Rr$	Z,N,V	1
ORI	Rd, K	Logical OR Register and Constant	$Rd \leftarrow Rd \vee K$	Z,N,V	1
EOR	Rd, Rr	Exclusive OR Registers	$Rd \leftarrow Rd \oplus Rr$	Z,N,V	1
COM	Rd	One's Complement	$Rd \leftarrow 0xFF - Rd$	Z,C,N,V	1
NEG	Rd	Two's Complement	$Rd \leftarrow 0x00 - Rd$	Z,C,N,V,H	1
SBR	Rd,K	Set Bit(s) in Register	$Rd \leftarrow Rd \vee K$	Z,N,V	1
CBR	Rd,K	Clear Bit(s) in Register	$Rd \leftarrow Rd \bullet (0xFF - K)$	Z,N,V	1
INC	Rd	Increment	$Rd \leftarrow Rd + 1$	Z,N,V	1
DEC	Rd	Decrement	$Rd \leftarrow Rd - 1$	Z,N,V	1
TST	Rd	Test for Zero or Minus	$Rd \leftarrow Rd \bullet Rd$	Z,N,V	1
CLR	Rd	Clear Register	$Rd \leftarrow Rd \oplus Rd$	Z,N,V	1
SER	Rd	Set Register	$Rd \leftarrow 0xFF$	None	1
MUL	Rd, Rr	Multiply Unsigned	$R1:R0 \leftarrow Rd \times Rr$	Z,C	2
MULS	Rd, Rr	Multiply Signed	$R1:R0 \leftarrow Rd \times Rr$	Z,C	2
MULSU	Rd, Rr	Multiply Signed with Unsigned	$R1:R0 \leftarrow Rd \times Rr$	Z,C	2
FMUL	Rd, Rr	Fractional Multiply Unsigned	$R1:R0 \leftarrow (Rd \times Rr) \lll 1$	Z,C	2
FMULS	Rd, Rr	Fractional Multiply Signed	$R1:R0 \leftarrow (Rd \times Rr) \lll 1$	Z,C	2
FMULSU	Rd, Rr	Fractional Multiply Signed with Unsigned	$R1:R0 \leftarrow (Rd \times Rr) \lll 1$	Z,C	2
<b>BRANCH INSTRUCTIONS</b>					
RJMP	k	Relative Jump	$PC \leftarrow PC + k + 1$	None	2
IJMP		Indirect Jump to (Z)	$PC \leftarrow Z$	None	2
JMP	k	Direct Jump	$PC \leftarrow k$	None	3
RCALL	k	Relative Subroutine Call	$PC \leftarrow PC + k + 1$	None	3
ICALL		Indirect Call to (Z)	$PC \leftarrow Z$	None	3
CALL	k	Direct Subroutine Call	$PC \leftarrow k$	None	4
RET		Subroutine Return	$PC \leftarrow STACK$	None	4
RETI		Interrupt Return	$PC \leftarrow STACK$	I	4
CPSE	Rd,Rr	Compare, Skip if Equal	if $(Rd = Rr)$ $PC \leftarrow PC + 2$ or $3$	None	1/2/3
CP	Rd,Rr	Compare	$Rd - Rr$	Z, N, V, C, H	1
CPC	Rd,Rr	Compare with Carry	$Rd - Rr - C$	Z, N, V, C, H	1
CPI	Rd,K	Compare Register with Immediate	$Rd - K$	Z, N, V, C, H	1
SBRC	Rr, b	Skip if Bit in Register Cleared	if $(Rr(b)=0)$ $PC \leftarrow PC + 2$ or $3$	None	1/2/3
SBRS	Rr, b	Skip if Bit in Register is Set	if $(Rr(b)=1)$ $PC \leftarrow PC + 2$ or $3$	None	1/2/3
SBIC	P, b	Skip if Bit in I/O Register Cleared	if $(P(b)=0)$ $PC \leftarrow PC + 2$ or $3$	None	1/2/3
SBIS	P, b	Skip if Bit in I/O Register is Set	if $(P(b)=1)$ $PC \leftarrow PC + 2$ or $3$	None	1/2/3
BRBS	s, k	Branch if Status Flag Set	if $(SREG(s) = 1)$ then $PC \leftarrow PC + k + 1$	None	1/2
BRBC	s, k	Branch if Status Flag Cleared	if $(SREG(s) = 0)$ then $PC \leftarrow PC + k + 1$	None	1/2
BREQ	k	Branch if Equal	if $(Z = 1)$ then $PC \leftarrow PC + k + 1$	None	1/2
BRNE	k	Branch if Not Equal	if $(Z = 0)$ then $PC \leftarrow PC + k + 1$	None	1/2
BRCS	k	Branch if Carry Set	if $(C = 1)$ then $PC \leftarrow PC + k + 1$	None	1/2
BRCC	k	Branch if Carry Cleared	if $(C = 0)$ then $PC \leftarrow PC + k + 1$	None	1/2
BRSH	k	Branch if Same or Higher	if $(C = 0)$ then $PC \leftarrow PC + k + 1$	None	1/2
BRLO	k	Branch if Lower	if $(C = 1)$ then $PC \leftarrow PC + k + 1$	None	1/2
BRMI	k	Branch if Minus	if $(N = 1)$ then $PC \leftarrow PC + k + 1$	None	1/2
BRPL	k	Branch if Plus	if $(N = 0)$ then $PC \leftarrow PC + k + 1$	None	1/2
BRGE	k	Branch if Greater or Equal, Signed	if $(N \oplus V = 0)$ then $PC \leftarrow PC + k + 1$	None	1/2
BRLT	k	Branch if Less Than Zero, Signed	if $(N \oplus V = 1)$ then $PC \leftarrow PC + k + 1$	None	1/2
BRHS	k	Branch if Half Carry Flag Set	if $(H = 1)$ then $PC \leftarrow PC + k + 1$	None	1/2
BRHC	k	Branch if Half Carry Flag Cleared	if $(H = 0)$ then $PC \leftarrow PC + k + 1$	None	1/2
BRTS	k	Branch if T Flag Set	if $(T = 1)$ then $PC \leftarrow PC + k + 1$	None	1/2
BRTC	k	Branch if T Flag Cleared	if $(T = 0)$ then $PC \leftarrow PC + k + 1$	None	1/2
BRVS	k	Branch if Overflow Flag is Set	if $(V = 1)$ then $PC \leftarrow PC + k + 1$	None	1/2
BRVC	k	Branch if Overflow Flag is Cleared	if $(V = 0)$ then $PC \leftarrow PC + k + 1$	None	1/2

Mnemonics	Operands	Description	Operation	Flags	#Clocks
BRIE	k	Branch if Interrupt Enabled	if (I = 1) then PC ← PC + k + 1	None	1/2
BRID	k	Branch if Interrupt Disabled	if (I = 0) then PC ← PC + k + 1	None	1/2
<b>BIT AND BIT-TEST INSTRUCTIONS</b>					
SBI	P,b	Set Bit in I/O Register	I/O(P,b) ← 1	None	2
CBI	P,b	Clear Bit in I/O Register	I/O(P,b) ← 0	None	2
LSL	Rd	Logical Shift Left	Rd(n+1) ← Rd(n), Rd(0) ← 0	Z,C,N,V	1
LSR	Rd	Logical Shift Right	Rd(n) ← Rd(n+1), Rd(7) ← 0	Z,C,N,V	1
ROL	Rd	Rotate Left Through Carry	Rd(0) ← C, Rd(n+1) ← Rd(n), C ← Rd(7)	Z,C,N,V	1
ROR	Rd	Rotate Right Through Carry	Rd(7) ← C, Rd(n) ← Rd(n+1), C ← Rd(0)	Z,C,N,V	1
ASR	Rd	Arithmetic Shift Right	Rd(n) ← Rd(n+1), n=0..6	Z,C,N,V	1
SWAP	Rd	Swap Nibbles	Rd(3..0) ← Rd(7..4), Rd(7..4) ← Rd(3..0)	None	1
BSET	s	Flag Set	SREG(s) ← 1	SREG(s)	1
BCLR	s	Flag Clear	SREG(s) ← 0	SREG(s)	1
BST	Rr, b	Bit Store from Register to T	T ← Rr(b)	T	1
BLD	Rd, b	Bit load from T to Register	Rd(b) ← T	None	1
SEC		Set Carry	C ← 1	C	1
CLC		Clear Carry	C ← 0	C	1
SEN		Set Negative Flag	N ← 1	N	1
CLN		Clear Negative Flag	N ← 0	N	1
SEZ		Set Zero Flag	Z ← 1	Z	1
CLZ		Clear Zero Flag	Z ← 0	Z	1
SEI		Global Interrupt Enable	I ← 1	I	1
CLI		Global Interrupt Disable	I ← 0	I	1
SES		Set Signed Test Flag	S ← 1	S	1
CLS		Clear Signed Test Flag	S ← 0	S	1
SEV		Set Twos Complement Overflow.	V ← 1	V	1
CLV		Clear Twos Complement Overflow	V ← 0	V	1
SET		Set T in SREG	T ← 1	T	1
CLT		Clear T in SREG	T ← 0	T	1
SEH		Set Half Carry Flag in SREG	H ← 1	H	1
CLH		Clear Half Carry Flag in SREG	H ← 0	H	1
<b>DATA TRANSFER INSTRUCTIONS</b>					
MOV	Rd, Rr	Move Between Registers	Rd ← Rr	None	1
MOVW	Rd, Rr	Copy Register Word	Rd+1:Rd ← Rr+1:Rr	None	1
LDI	Rd, K	Load Immediate	Rd ← K	None	1
LD	Rd, X	Load Indirect	Rd ← (X)	None	2
LD	Rd, X+	Load Indirect and Post-Inc.	Rd ← (X), X ← X + 1	None	2
LD	Rd, -X	Load Indirect and Pre-Dec.	X ← X - 1, Rd ← (X)	None	2
LD	Rd, Y	Load Indirect	Rd ← (Y)	None	2
LD	Rd, Y+	Load Indirect and Post-Inc.	Rd ← (Y), Y ← Y + 1	None	2
LD	Rd, -Y	Load Indirect and Pre-Dec.	Y ← Y - 1, Rd ← (Y)	None	2
LDD	Rd, Y+q	Load Indirect with Displacement	Rd ← (Y + q)	None	2
LD	Rd, Z	Load Indirect	Rd ← (Z)	None	2
LD	Rd, Z+	Load Indirect and Post-Inc.	Rd ← (Z), Z ← Z+1	None	2
LD	Rd, -Z	Load Indirect and Pre-Dec.	Z ← Z - 1, Rd ← (Z)	None	2
LDD	Rd, Z+q	Load Indirect with Displacement	Rd ← (Z + q)	None	2
LDS	Rd, k	Load Direct from SRAM	Rd ← (k)	None	2
ST	X, Rr	Store Indirect	(X) ← Rr	None	2
ST	X+, Rr	Store Indirect and Post-Inc.	(X) ← Rr, X ← X + 1	None	2
ST	-X, Rr	Store Indirect and Pre-Dec.	X ← X - 1, (X) ← Rr	None	2
ST	Y, Rr	Store Indirect	(Y) ← Rr	None	2
ST	Y+, Rr	Store Indirect and Post-Inc.	(Y) ← Rr, Y ← Y + 1	None	2
ST	-Y, Rr	Store Indirect and Pre-Dec.	Y ← Y - 1, (Y) ← Rr	None	2
STD	Y+q, Rr	Store Indirect with Displacement	(Y + q) ← Rr	None	2
ST	Z, Rr	Store Indirect	(Z) ← Rr	None	2
ST	Z+, Rr	Store Indirect and Post-Inc.	(Z) ← Rr, Z ← Z + 1	None	2
ST	-Z, Rr	Store Indirect and Pre-Dec.	Z ← Z - 1, (Z) ← Rr	None	2
STD	Z+q, Rr	Store Indirect with Displacement	(Z + q) ← Rr	None	2
STS	k, Rr	Store Direct to SRAM	(k) ← Rr	None	2
LPM		Load Program Memory	R0 ← (Z)	None	3
LPM	Rd, Z	Load Program Memory	Rd ← (Z)	None	3
LPM	Rd, Z+	Load Program Memory and Post-Inc	Rd ← (Z), Z ← Z+1	None	3
SPM		Store Program Memory	(Z) ← R1:R0	None	-
IN	Rd, P	In Port	Rd ← P	None	1
OUT	P, Rr	Out Port	P ← Rr	None	1
PUSH	Rr	Push Register on Stack	STACK ← Rr	None	2

Mnemonics	Operands	Description	Operation	Flags	#Clocks
POP	Rd	Pop Register from Stack	Rd ← STACK	None	2
<b>MCU CONTROL INSTRUCTIONS</b>					
NOP		No Operation		None	1
SLEEP		Sleep	(see specific descr. for Sleep function)	None	1
WDR		Watchdog Reset	(see specific descr. for WDR/timer)	None	1
BREAK		Break	For On-chip Debug Only	None	N/A



## Ordering Information

Speed (MHz)	Power Supply	Ordering Code	Package <sup>(1)</sup>	Operation Range
8 <sup>(2)</sup>	1.8 - 5.5V	ATmega169V-8AI ATmega169V-8AJ <sup>(3)</sup> ATmega169V-8MI ATmega169V-8MJ <sup>(3)</sup>	64A 64A 64M1 64M1	Industrial (-40°C to 85°C)
16 <sup>(2)</sup>	4.5 - 5.5V	ATmega169-16AI ATmega169-16AJ <sup>(3)</sup> ATmega169-16MI ATmega169-16MJ <sup>(3)</sup>	64A 64A 64M1 64M1	Industrial (-40°C to 85°C)

- Notes:
1. This device can also be supplied in wafer form. Please contact your local Atmel sales office for detailed ordering information and minimum quantities.
  2. See Figure 135 and Figure 136.
  3. Pb-free alternative.

Package Type	
<b>64A</b>	64-Lead, Thin (1.0 mm) Plastic Gull Wing Quad Flat Package (TQFP)
<b>64M1</b>	64-pad, 9 x 9 x 1.0 mm body, lead pitch 0.50 mm, Micro Lead Frame Package (MLF)

Packaging Information

64A

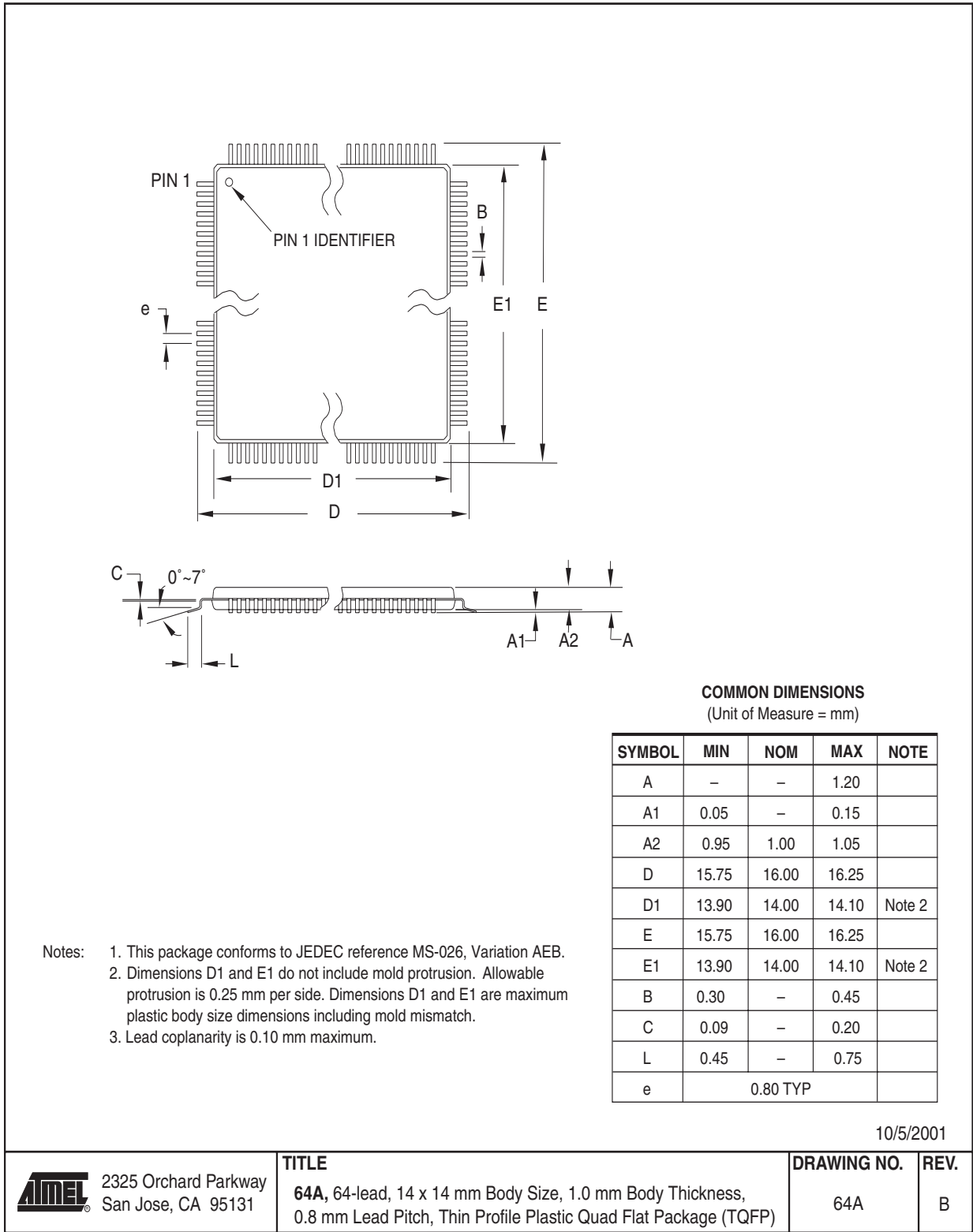

64M1

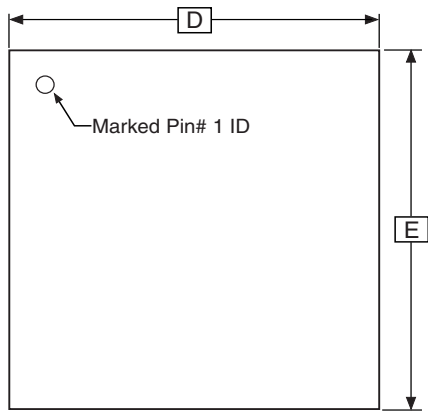

TOP VIEW

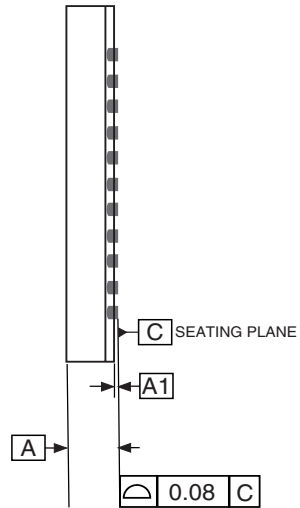

SIDE VIEW

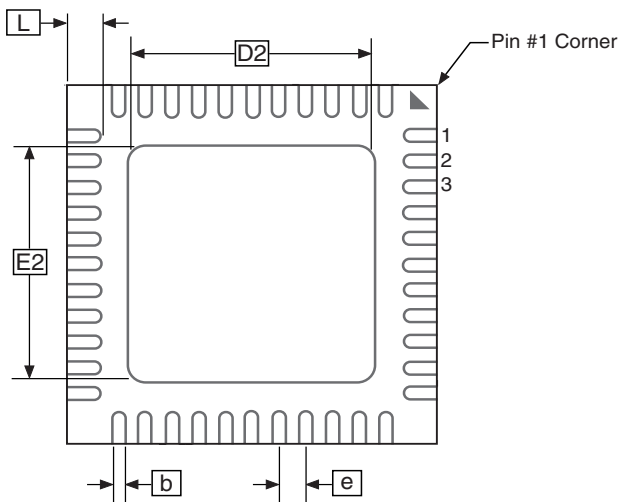

BOTTOM VIEW

COMMON DIMENSIONS  
(Unit of Measure = mm)

SYMBOL	MIN	NOM	MAX	NOTE
A	0.80	0.90	1.00	
A1	-	0.02	0.05	
b	0.23	0.25	0.28	
D	9.00 BSC			
D2	5.20	5.40	5.60	
E	9.00 BSC			
E2	5.20	5.40	5.60	
e	0.50 BSC			
L	0.35	0.40	0.45	

Notes: 1. JEDEC Standard MO-220, Fig. 1, VMMD.

01/15/03



2325 Orchard Parkway  
San Jose, CA 95131

TITLE

64M1, 64-pad, 9 x 9 x 1.0 mm Body, Lead Pitch 0.50 mm  
Micro Lead Frame Package (MLF)

DRAWING NO.

64M1

REV.

C

## Errata

### ATmega169 Rev E

No known errata.

### ATmega169 Rev D

- **High serial resistance in the glass can result in dim segments on the LCD**
  - **IDCODE masks data from TDI input**
2. **High serial resistance in the glass can result in dim segments on the LCD**  
Some display types with high serial resistance (>20 kΩ) inside the glass can result in dim segments on the LCD  
**Problem Fix/Workaround**  
Add a 1 nF (0.47 - 1.5 nF) capacitor between each common pin and ground.
  1. **IDCODE masks data from TDI input**  
The JTAG instruction IDCODE is not working correctly. Data to succeeding devices are replaced by all-ones during Update-DR.  
**Problem Fix / Workaround**
    - If ATmega169 is the only device in the scan chain, the problem is not visible.
    - Select the Device ID Register of the ATmega169 by issuing the IDCODE instruction or by entering the Test-Logic-Reset state of the TAP controller to read out the contents of its Device ID Register and possibly data from succeeding devices of the scan chain. Issue the BYPASS instruction to the ATmega169 while reading the Device ID Registers of preceding devices of the boundary scan chain.
    - If the Device IDs of all devices in the boundary scan chain must be captured simultaneously, the ATmega169 must be the first device in the chain.

### ATmega169 Rev C

- **High Current Consumption In Power Down when JTAGEN is Programmed**
  - **LCD Contrast Control**
  - **Some Data Combinations Can Result in Dim Segments on the LCD**
  - **LCD Current Consumption**
  - **IDCODE masks data from TDI input**
5. **High Current Consumption In Power Down when JTAGEN is Programmed**  
The input buffer on TDO (PF6) is always enabled and the pull-up is always disabled when JTAG is programmed. This can leave the output floating.  
**Problem Fix/Workaround**  
Add external pull-up to PF6.  
Unprogram the JTAGEN Fuse before shipping out the end product.
  4. **LCD Contrast Control**  
The contrast control is not working properly when using synchronous clock (chip clock) to obtain an LCD clock, and the chip clock is 125 kHz or faster.  
**Problem Fix/Workaround**  
Use a low chip clock frequency (32 kHz) or apply an external voltage to the LCD-CAP pin.
  3. **Some Data Combinations Can Result in Dim Segments on the LCD**



All segments connected to a common plane might be dimmed (lower contrast) when a certain combination of data is displayed.

**Problem Fix/Workaround**

Default waveform: If there are any unused segment pins, loading one of these with a 1 nF capacitor and always write '0' to this segment eliminates the problem.

Low power waveform: Add a 1 nF capacitor to each common pin.

**2. LCD Current Consumption**

In an interval where  $V_{CC}$  is within the range  $V_{LCD} - 0.2V$  to  $V_{LCD} + 0.4V$ , the LCD current consumption is up to three times higher than expected. This will only be an issue in Power-save mode with the LCD running as the LCD current is negligible compared to the overall power consumption in all other modes of operation.

**Problem Fix/Workaround**

No known workaround.

**1. IDCODE masks data from TDI input**

The JTAG instruction IDCODE is not working correctly. Data to succeeding devices are replaced by all-ones during Update-DR.

**Problem Fix / Workaround**

- If ATmega169 is the only device in the scan chain, the problem is not visible.
- Select the Device ID Register of the ATmega169 by issuing the IDCODE instruction or by entering the Test-Logic-Reset state of the TAP controller to read out the contents of its Device ID Register and possibly data from succeeding devices of the scan chain. Issue the BYPASS instruction to the ATmega169 while reading the Device ID Registers of preceding devices of the boundary scan chain.
- If the Device IDs of all devices in the boundary scan chain must be captured simultaneously, the ATmega169 must be the first device in the chain.

**ATmega169 Rev B**

- **Internal Oscillator Runs at 4 MHz**
- **LCD Contrast Voltage is not Correct**
- **External Oscillator is Non-functional**
- **USART**
- **ADC Measures with Lower Accuracy than Specified**
- **Serial Downloading**
- **IDCODE masks data from TDI input**

**7. Internal Oscillator Runs at 4 MHz**

The Internal Oscillator runs at 4 MHz instead of the specified 8 MHz. Therefore, all Flash/EEPROM programming times are twice as long as specified. This includes Chip Erase, Byte programming, Page programming, Fuse programming, Lock bit programming, EEPROM write from the CPU, and Flash Self-Programming.

For this reason, rev-B samples are shipped with the CKDIV8 Fuse unprogrammed.

**Problem Fix/Workaround**

If 8 MHz operation is required, apply an external clock (this will be fixed in rev. C).

**6. LCD Contrast Voltage is not Correct**

The LCD contrast voltage between 1.8V and 3.1V is incorrect. When the  $V_{CC}$  is between 1.8V and 3.1V, the LCD contrast voltage drops approx. 0.5V. The current consumption in this interval is higher than expected.

## **Problem Fix/Workaround**

Contrast will be wrong, but display will still be readable, can be partly compensated for using the contrast control register (this will be fixed in rev. C).

## **5. External Oscillator is Non-functional**

The external oscillator does not run with the setup described in the datasheet.

### **Problem Fix/Workaround**

Use other clock source (this will be fixed in rev. C).

### **Alternative Problem Fix/Workaround**

Adding a pull-down on XTAL1 will start the Oscillator.

## **4. USART**

Writing TXEN to zero during transmission causes the transmission to suddenly stop. The datasheet description tells that the transmission should complete before stopping the USART when TXEN is written to zero.

### **Problem Fix/Workaround**

Ensure that the transmission is complete before writing TXEN to zero (this will be fixed in rev. C).

## **3. ADC Measures with Lower Accuracy than Specified**

The ADC does not work as intended. There is a positive offset in the result.

### **Problem Fix/Workaround**

This will be fixed in rev. C.

## **2. Serial downloading**

When entering Serial Programming mode the second byte will not echo back as described in the Serial Programming algorithm.

### **Problem Fix/Workaround**

Check if the third byte echoes back to ensure that the device is in Programming mode (this will be fixed in rev. C).

## **1. IDCODE masks data from TDI input**

The JTAG instruction IDCODE is not working correctly. Data to succeeding devices are replaced by all-ones during Update-DR.

### **Problem Fix / Workaround**

- If ATmega169 is the only device in the scan chain, the problem is not visible.
- Select the Device ID Register of the ATmega169 by issuing the IDCODE instruction or by entering the Test-Logic-Reset state of the TAP controller to read out the contents of its Device ID Register and possibly data from succeeding devices of the scan chain. Issue the BYPASS instruction to the ATmega169 while reading the Device ID Registers of preceding devices of the boundary scan chain.
- If the Device IDs of all devices in the boundary scan chain must be captured simultaneously, the ATmega169 must be the first device in the chain.



## Datasheet Change Log for ATmega169

Please note that the referring page numbers in this section are referring to this document. The referring revision in this section are referring to the document revision.

### Changes from Rev. 2514J-12/03 to Rev. 2514K-04/04

1. Changed size from 0x60 to 0xFF in “Stack Pointer” on page 11.
2. Updated Table 17 on page 40, Table 21 on page 44 and Table 115 on page 267.
3. Updated “Calibrated Internal RC Oscillator” on page 27.
4. Added new “Power Reduction Register” on page 34. Examples found in “Using the Power Reduction Register” on page 312.
5. Fixed typo in port description for the “Analog to Digital Converter” on page 194.
6. Removed old and added new “LCD Controller” on page 212.
7. Updated “Electrical Characteristics” on page 300.
8. Updated “ATmega169 Typical Characteristics” on page 307.
9. Updated “Ordering Information” on page 14. ATmega169L replaced by ATmega169V and ATmega169.

### Changes from Rev. 2514I-09/03 to Rev. 2514J-12/03

1. Updated “Calibrated Internal RC Oscillator” on page 27

### Changes from Rev. 2514H-05/03 to Rev. 2514I-09/03

1. Removed “Advance Information” from the datasheet.
2. Removed AGND from Figure 2 on page 3 and added “System Clock Prescaler” to Figure 11 on page 23.
3. Updated Table 16 on page 38, Table 17 on page 40, Table 19 on page 42 and Table 40 on page 70.
4. Renamed and updated “On-chip Debug System” to “JTAG Interface and On-chip Debug System” on page 36.
5. Updated COM01:0 to COM0A1:0 in “Timer/Counter Control Register A – TCCR0A” on page 90 and COM21:0 to COM2A1:0 in “Timer/Counter Control Register A– TCCR2A” on page 136.
6. Updated “Test Access Port – TAP” on page 228 regarding JTAGEN.
7. Updated description for the JTD bit on page 237.
8. Added a note regarding JTAGEN fuse to Table 119 on page 270.
9. Updated Absolute Maximum Ratings\* and DC Characteristics in “Electrical Characteristics” on page 300.
10. Updated “Errata” on page 17 and added a proposal for solving problems regarding the JTAG instruction IDCODE.

**Changes from Rev.  
2514G-04/03 to Rev.  
2514H-05/03**

1. Updated typo in Figure 147, Figure 167, and Figure 194.

**Changes from Rev.  
2514F-04/03 to Rev.  
2514G-04/03**

1. Updated “ATmega169 Typical Characteristics” on page 307.
2. Updated typo in “Ordering Information” on page 14.
3. Updated Figure 45 on page 110, Table 18 on page 40, and “Version” on page 235.

**Changes from Rev.  
2514E-02/03 to Rev.  
2514F-04/03**

1. Renamed ICP to ICP1 in whole document.
2. Removed note on “Crystal Oscillator Operating Modes” on page 25.
3. XTAL1/XTAL2 can be used as timer oscillator pins, described in chapter “Calibrated Internal RC Oscillator” on page 27.
4. Switching between prescaler settings in “Switching Time” on page 31.
5. Updated DC and ACD Characteristics in chapter “Electrical Characteristics” on page 300 are updated. Removed TBD’s from Table 16 on page 38, Table 19 on page 42, Table 134 on page 303.
6. Updated Figure 22 on page 53, Figure 25 on page 58 and Figure 109 on page 240 regarding WRITE PINx REGISTER.
7. Updated “Alternate Functions of Port F” on page 70 regarding JTAG.
8. Replaced Timer0 Overflow with Timer/Counter0 Compare Match in “Universal Serial Interface – USI” on page 180. Also updated “Start Condition Detector” on page 186 and “USI Control Register – USICR” on page 188.
9. Updated Features for “Analog to Digital Converter” on page 194 and Table 88 on page 207.
10. Added notes on Figure 117 on page 261 and Table 118 on page 269.

**Changes from Rev.  
2514D-01/03 to Rev.  
2514E-02/03**

1. Updated the section “Features” on page 1 with information regarding ATmega169 and ATmega169L.
2. Removed all references to the PG5 pin in Figure 1 on page 2, Figure 2 on page 3, “Port G (PG4..PG0)” on page 6, “Alternate Functions of Port G” on page 72, and “Register Description for I/O-Ports” on page 74.
3. Updated Table 118, “Extended Fuse Byte,” on page 269.
4. Added Errata for “Datasheet Change Log for ATmega169” on page 20, including “Significant Data Sheet Changes”.
5. Updated the “Ordering Information” on page 14 to include the new speed grade for ATmega169L and the new 16 MHz ATmega169.

**Changes from Rev.  
2514C-11/02 to Rev.  
2514D-01/03**

1. Added TCK frequency limit in “Programming via the JTAG Interface” on page 287.
2. Added Chip Erase as a first step in “Programming the Flash” on page 297 and “Programming the EEPROM” on page 298.
3. Added the section “Unconnected Pins” on page 57.
4. Added tips on how to disable the OCD system in “On-chip Debug System” on page 35.
5. Corrected interrupt addresses. ADC and ANA\_COMP had swapped places.
6. Improved the table in “SPI Timing Characteristics” on page 303 and removed the table in “SPI Serial Programming Characteristics” on page 287.
7. Changed “will be ignored” to “must be written to zero” for unused Z-pointer bits in “Performing a Page Write” on page 262.
8. Corrected “LCD Frame Complete” to “LCD Start of Frame” in the LCDCRA Register description.
9. Changed OUT to STS and IN to LDS in USI code examples, and corrected  $f_{SCKmax}$ . The USI I/O Registers are in the extended I/O space, so IN and OUT cannot be used. LDS and STS take one more cycle when executed, so  $f_{SCKmax}$  had to be changed accordingly.
10. Removed TOSKON and TOSCK from Table 103 on page 241, and g10 and g20 from Figure 114 on page 243 and Table 105 on page 244, because these signals do not exist in boundary scan.
11. Changed from 4 to 16 MIPS and MHz in the device Features list.
12. Corrected Port A to Port F in “AVCC” on page 6 under “Pin Descriptions” on page 5.
13. Corrected 230.4 Mbps to 230.4 kbps in “Examples of Baud Rate Setting” on page 176.
14. Corrected placing of falling and rising XCK edges in Table 78, “UCPOL Bit Settings,” on page 175.
15. Removed reference to Multipurpose Oscillator Application Note, which does not exist.
16. Corrected Number of Calibrated RC Oscillator Cycles in Table 1 on page 19 from 8,448 to 67,584.
17. Various minor Timer1 corrections.
18. Added information about PWM symmetry for Timer0 and Timer2.
19. Corrected the contents of DIDR0 and DIDR1.

20. Made all bit names in the LCDDR Registers unique by adding the COM number digit in front of the two digits already there, e.g. SEG304.
21. Changed Extended Standby to ADC Noise Reduction mode under “Asynchronous Operation of Timer/Counter2” on page 140.
22. Added note about Port B having better driving capabilities than the other ports. As a consequence the table, “DC Characteristics” on page 300 was corrected as well.
23. Added note under “Filling the Temporary Buffer (Page Loading)” on page 262 about writing to the EEPROM during an SPM page load.
24. Removed ADHSM completely.
25. Updated “Packaging Information” on page 15.

**Changes from Rev.  
2514B-09/02 to Rev.  
2514C-11/02**

1. Added “Errata” on page 17.
2. Added Information for the 64-pad MLF Package in “Ordering Information” on page 14 and “Packaging Information” on page 15.
3. Changed Temperature Range and Removed Industrial Ordering Codes in “Packaging Information” on page 15.

**Changes from Rev.  
2514A-08/02 to Rev.  
2514B-09/02**

1. Changed the Endurance on the Flash to 10,000 Write/Erase Cycles.



## Atmel Corporation

2325 Orchard Parkway  
San Jose, CA 95131, USA  
Tel: 1(408) 441-0311  
Fax: 1(408) 487-2600

## Regional Headquarters

### Europe

Atmel Sarl  
Route des Arsenaux 41  
Case Postale 80  
CH-1705 Fribourg  
Switzerland  
Tel: (41) 26-426-5555  
Fax: (41) 26-426-5500

### Asia

Room 1219  
Chinachem Golden Plaza  
77 Mody Road Tsimshatsui  
East Kowloon  
Hong Kong  
Tel: (852) 2721-9778  
Fax: (852) 2722-1369

### Japan

9F, Tonetsu Shinkawa Bldg.  
1-24-8 Shinkawa  
Chuo-ku, Tokyo 104-0033  
Japan  
Tel: (81) 3-3523-3551  
Fax: (81) 3-3523-7581

## Atmel Operations

### Memory

2325 Orchard Parkway  
San Jose, CA 95131, USA  
Tel: 1(408) 441-0311  
Fax: 1(408) 436-4314

### Microcontrollers

2325 Orchard Parkway  
San Jose, CA 95131, USA  
Tel: 1(408) 441-0311  
Fax: 1(408) 436-4314

La Chantrerie  
BP 70602  
44306 Nantes Cedex 3, France  
Tel: (33) 2-40-18-18-18  
Fax: (33) 2-40-18-19-60

### ASIC/ASSP/Smart Cards

Zone Industrielle  
13106 Rousset Cedex, France  
Tel: (33) 4-42-53-60-00  
Fax: (33) 4-42-53-60-01

1150 East Cheyenne Mtn. Blvd.  
Colorado Springs, CO 80906, USA  
Tel: 1(719) 576-3300  
Fax: 1(719) 540-1759

Scottish Enterprise Technology Park  
Maxwell Building  
East Kilbride G75 0QR, Scotland  
Tel: (44) 1355-803-000  
Fax: (44) 1355-242-743

### RF/Automotive

Theresienstrasse 2  
Postfach 3535  
74025 Heilbronn, Germany  
Tel: (49) 71-31-67-0  
Fax: (49) 71-31-67-2340

1150 East Cheyenne Mtn. Blvd.  
Colorado Springs, CO 80906, USA  
Tel: 1(719) 576-3300  
Fax: 1(719) 540-1759

### Biometrics/Imaging/Hi-Rel MPU/ High Speed Converters/RF Datacom

Avenue de Rochepleine  
BP 123  
38521 Saint-Egreve Cedex, France  
Tel: (33) 4-76-58-30-00  
Fax: (33) 4-76-58-34-80

---

### Literature Requests

[www.atmel.com/literature](http://www.atmel.com/literature)

**Disclaimer:** Atmel Corporation makes no warranty for the use of its products, other than those expressly contained in the Company's standard warranty which is detailed in Atmel's Terms and Conditions located on the Company's web site. The Company assumes no responsibility for any errors which may appear in this document, reserves the right to change devices or specifications detailed herein at any time without notice, and does not make any commitment to update the information contained herein. No licenses to patents or other intellectual property of Atmel are granted by the Company in connection with the sale of Atmel products, expressly or by implication. Atmel's products are not authorized for use as critical components in life support devices or systems.

© Atmel Corporation 2004. All rights reserved.

Atmel<sup>®</sup> and combinations thereof, AVR<sup>®</sup>, and AVR Studio<sup>®</sup> are the registered trademarks of Atmel Corporation or its subsidiaries. Microsoft<sup>®</sup>, Windows<sup>®</sup>, Windows NT<sup>®</sup>, and Windows XP<sup>®</sup> are the registered trademarks of Microsoft Corporation. Other terms and product names may be the trademarks of others





Printed on recycled paper.

2514KS-AVR-05/04

## Looking for pricing, stock, or lifecycle information?

Click below to explore more details on WIN SOURCE:

-  [View ATMEGA169V-8MI on WIN SOURCE](#)
-  [Microchip Technology](#) Information

## Optimize Your Supply Chain with WIN SOURCE Solutions

-  Global Sourcing Solution
-  Obsolete Management
-  Cost Control Management
-  Shortage Management
-  Alternative Solution
-  Excess Inventory Management