

RX30 SERIES

Load Life : 130°C 1000~4000 hours

- For Automotive and LED Lighting applications.
- AEC-Q200.

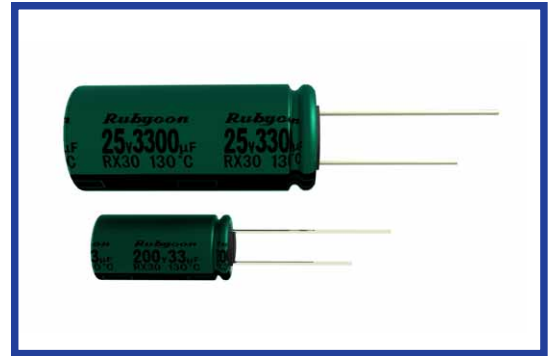

◆SPECIFICATIONS

Items	Characteristics	
Category Temperature Range	-40~+130°C	-25~+130°C
Rated Voltage Range	10~100Vdc	200, 400Vdc
Capacitance Tolerance	±20%(20°C,120Hz)	
Leakage Current(MAX)	I=0.01CV or 3μA whichever is greater. (After 2 minutes application of rated voltage)	CV≤1000
		CV>1000
		I=0.1CV+40μA (1 minute) I=0.03CV+15μA (5 minutes)
		I=0.04CV+100μA (1 minute) I=0.02CV+25μA (5 minutes)
	I=Leakage Current(μA)	C=Capacitance(μF) V=Rated Voltage(Vdc)
Dissipation Factor(MAX) (tanδ)	Rated Voltage (Vdc)	
	tanδ	
Endurance	After applying rated voltage with rated ripple current for specified time at 130°C, the capacitors shall meet the following requirements.	
		10~100Vdc
	Capacitance Change	Within ±30% of the initial value.
	Dissipation Factor	Not more than 300% of the specified value.
	Leakage Current	Not more than the specified value.
	200, 400Vdc	
Case Size	Life Time (hrs)	
	10~100Vdc	200, 400Vdc
φD=6.3	—	1000
φD=8, 10	2000	2000
φD≥12.5	4000	—
Low Temperature Stability Impedance Ratio(MAX)	Rated Voltage (Vdc)	
	Z(-25°C)/Z(20°C)	
	Z(-40°C)/Z(20°C)	

◆MULTIPLIER FOR RIPPLE CURRENT

10~100Vdc

Frequency (Hz)	60(50)	120	1k	10k	100k≤
4.7μF	0.35	0.42	0.60	0.80	1.00
10~33μF	0.45	0.55	0.75	0.90	1.00
47~330μF	0.60	0.70	0.85	0.95	1.00
470~1500μF	0.65	0.75	0.90	0.98	1.00
2200~4700μF	0.75	0.80	0.95	1.00	1.00

200, 400Vdc

Frequency (Hz)	120	1k	10k	100k≤
1~5.6μF	0.20	0.40	0.80	1.00
6.8~15μF	0.30	0.60	0.90	1.00
22~33μF	0.50	0.80	0.90	1.00

◆DIMENSIONS

(mm)

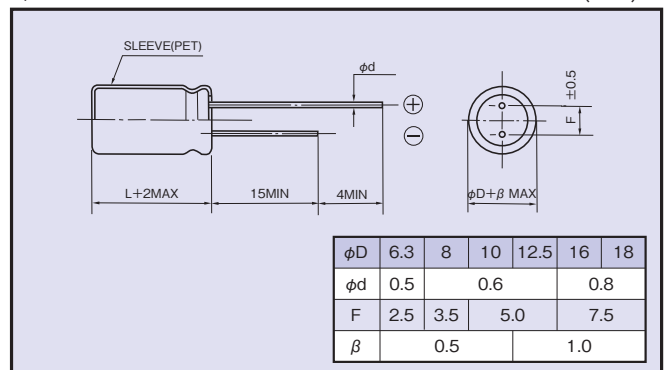

◆PART NUMBER

□□□ RX30 □□□□□ M □□□ □□ D×L
 Rated Voltage Series Capacitance Capacitance Tolerance Option Lead Forming Case Size

◆OPTION

Code
PET Sleeve
Blank



◆STANDARD SIZE

Rated Voltage (Vdc)	Capacitance (μF)	Size φD×L(mm)	Rated ripple current (mA r.m.s./130°C, 100kHz)	Impedance (Ω MAX)
				20°C, 100kHz
10	330	8×11.5	360	0.22
	470	10×12.5	620	0.15
	1000	10×20	960	0.073
	2200	12.5×25	1430	0.040
	3300	16×25	1900	0.038
	4700	16×31.5	2300	0.034
16	330	8×11.5	360	0.22
	470	10×12.5	620	0.15
	1000	10×20	960	0.073
	2200	12.5×25	1430	0.040
	3300	16×31.5	2300	0.034
	4700	16×35.5	2550	0.031
25	220	8×11.5	360	0.22
	330	10×12.5	620	0.15
	470	10×16	800	0.10
	1000	12.5×20	1100	0.055
	2200	16×31.5	2300	0.034
35	100	8×11.5	360	0.22
	220	10×12.5	620	0.15
	330	10×16	800	0.10
	470	10×20	960	0.073
	1000	12.5×25	1430	0.040
	2200	16×35.5	2550	0.031
50	3300	18×35.5	2800	0.028
	4.7	8×11.5	100	0.85
	10	8×11.5	200	0.60
	22	8×11.5	260	0.35
	33	8×11.5	300	0.28
	47	8×11.5	300	0.28
63	100	10×12.5	520	0.18
	220	10×20	890	0.082
	330	12.5×20	1000	0.065
	470	12.5×25	1200	0.051
	1000	16×31.5	2180	0.037
	2200	18×40	2800	0.029
	33	8×11.5	250	0.40
	47	10×12.5	400	0.27
	100	10×16	450	0.20
100	220	12.5×20	820	0.10
	330	12.5×25	1000	0.072
	470	16×25	1500	0.069
	1000	16×31.5	1850	0.056
	1500	18×40	2350	0.043
	4.7	8×11.5	100	1.3
	10	8×11.5	200	1.0
22	8×11.5	220	0.67	
100	33	10×12.5	260	0.45
	47	10×16	330	0.33
	100	12.5×20	670	0.17
	220	16×25	1100	0.13
	330	16×31.5	1300	0.10
	470	18×31.5	1600	0.092





Rated Voltage (Vdc)	Capacitance (μF)	Size φD×L(mm)	Rated ripple current (mA r.m.s./130°C, 100kHz)
8×11.5	120		
5.6	8×11.5	130	
	8×16	180	
6.8	8×11.5	130	
	8×16	180	
10	8×16	200	
	8×20	240	
15	8×16	200	
	8×20	240	
22	8×20	300	
	10×16	240	
33	10×20	320	
400	1	6.3×11	60
		8×11.5	65
	1.5	8×11.5	75
		8×16	80
	1.8	8×11.5	75
		8×16	85
	2.2	8×11.5	75
		8×16	90
	2.2	8×20	110
		2.7	8×16
	8×20		115
	3.3	8×16	100
		8×20	120
	4.7	8×20	120
		10×16	125
5.6	10×16	130	
	10×20	145	
6.8	10×20	150	

Looking for pricing, stock, or lifecycle information?

Click below to explore more details on WIN SOURCE:

-  [View 160RX3027AT810X16 on WIN SOURCE](#)
-  [Rubycon Information](#)

Optimize Your Supply Chain with WIN SOURCE Solutions

-  Global Sourcing Solution
-  Obsolete Management
-  Cost Control Management
-  Shortage Management
-  Alternative Solution
-  Excess Inventory Management