



THE DATASHEET OF AS3607 EVAL BOARD



AS3606/7 – AN01 - Evalboard

System PMU with HV Back Light Driver

1 General Description

The AS3606/07 is an ultra compact System PMU with integrated battery charger and HV back light driver. The device offers advanced power management functions. All necessary ICs and peripherals in a battery powered mobile device are supplied by the AS3606/07. It features 3 DCDC converters as well as 5 low noise LDOs.

The different regulated supply voltages are programmable via the serial control interface.

The step-up converter for the backlight can operate up to 26V. Both constant voltage (OLED supply) as well as constant current (white LED backlight) operations with 2 current sinks are possible. An internal voltage protection is limiting the output voltage in the case of external component failures.

AS3606/07 also contains a Li-Ion battery charger with constant current and constant voltage. The maximum charging current is 1A. An integrated battery switch and an optional external switch are separating the battery during charging or whenever an external power supply is present. With this switch it is also possible to operate with no or deeply discharged batteries. A programmable current limit can be used to control the maximum current used from a USB supply.

The single supply voltage may vary from 2.7V to 5.5V.

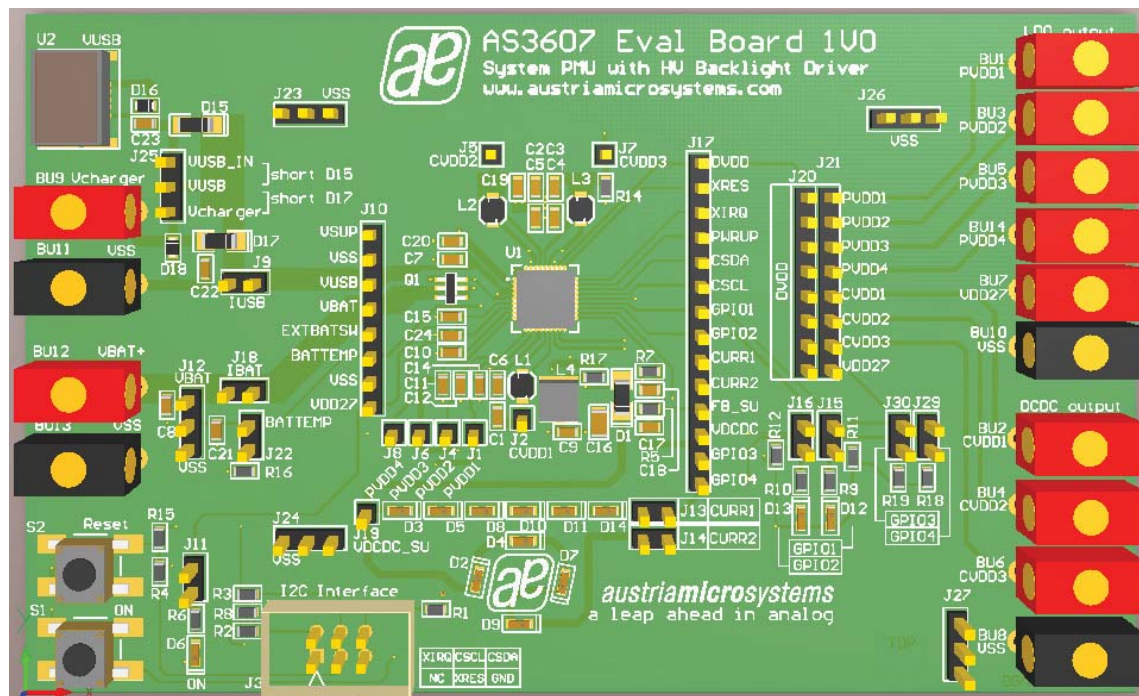

Table of Contents

1	GENERAL DESCRIPTION	1
2	OTHER APPLICABLE DOCUMENTS AND PAPERS	3
3	FURTHER APPLICATIONS	3
4	REVISION STATUS	3
5	GENERAL DESCRIPTION	3
6	GETTING STARTED	4
6.1	AS3606/07 Demo Software Installation.....	4
6.2	Connecting the Evalboard and USB Box with the PC.....	5
6.3	Starting the AS3607 Demo software.....	6
7	AS3607 EVALBOARD 1V0 CONNECTOR AND JUMPER LOCATIONS	7
8	APPLICATION SCHEMATIC OF AS3607 EVALBOARD 1V0	9
9	AS3607 EVALBOARD 1V0: LAYOUT (TOP VIEW)	11
10	AS3607 EVALBOARD 1V0: LAYOUT (MID LAYER 1)	11
11	AS3607 EVALBOARD 1V0: LAYOUT (MID LAYER 2)	12
12	AS3607 EVALBOARD 1V0: LAYOUT (BOTTOM VIEW)	12
13	AS3606 EVALBOARD 1V1 CONNECTOR AND JUMPER LOCATIONS	13
14	APPLICATION SCHEMATIC OF AS3606 EVALBOARD 1V1	15
15	AS3606 EVALBOARD 1V1: LAYOUT (TOP VIEW)	17
16	AS3606 EVALBOARD 1V1: LAYOUT (MID LAYER 1)	17
17	AS3606 EVALBOARD 1V1: LAYOUT (MID LAYER 2)	18
18	AS3606 EVALBOARD 1V1: LAYOUT (BOTTOM VIEW)	18
	COPYRIGHT	19

2 Other applicable documents and papers

Data Sheet: AS3607 0v1

3 Further Applications

Applications based on the AS3607 are continuously updated. Visit our home-page:
<http://www.austriamicrosystems.com>

4 Revision status

AS3607_AN01_Evalboard Application note (this document):	Rev.: 1v1
AS3607 Evalboard schematic:	Rev.: 1v0
AS3607 Evalboard layout	Rev.: 1v0
AS3606 Evalboard schematic:	Rev.: 1v1
AS3606 Evalboard layout	Rev.: 1v1

5 General description

Remark: all subsequent component numbering refers to the application schematics, shown in pt. Application Schematic.

6 Getting Started

6.1 AS3606/07 Demo Software Installation

Start the demo software Installation Shield with "Install Demo Software". The Install Shield will guide you through the rest of the installation.

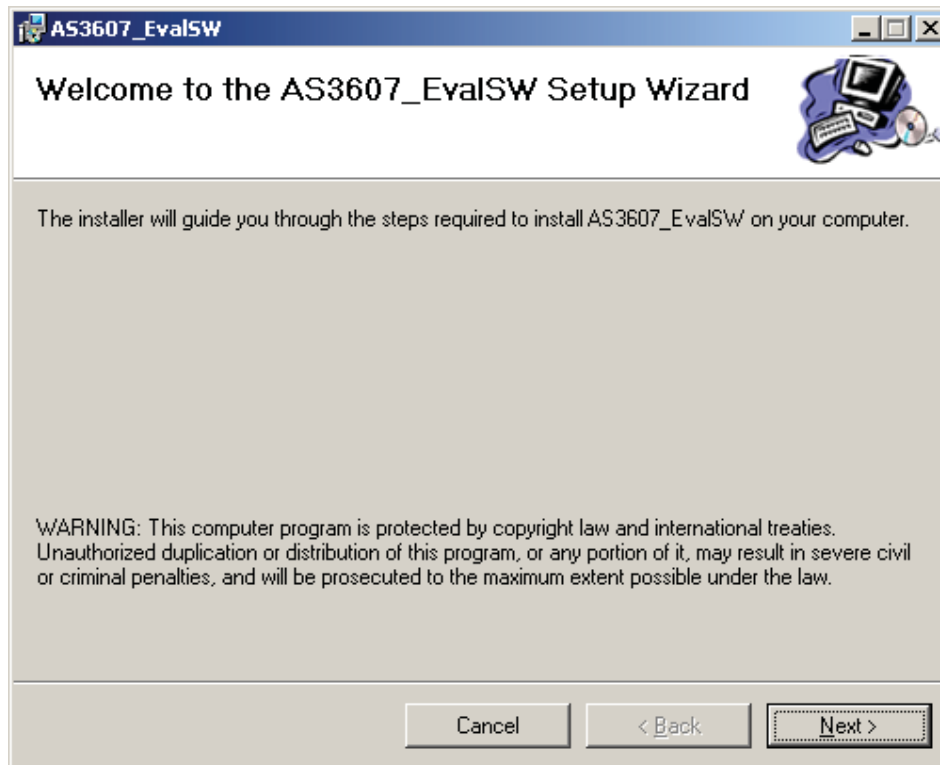

6.2 Connecting the Evalboard and USB Box with the PC

After the successful installation of the demo software, the USB Box can be connected to the PC and to the Evalboard as shown in the picture below.

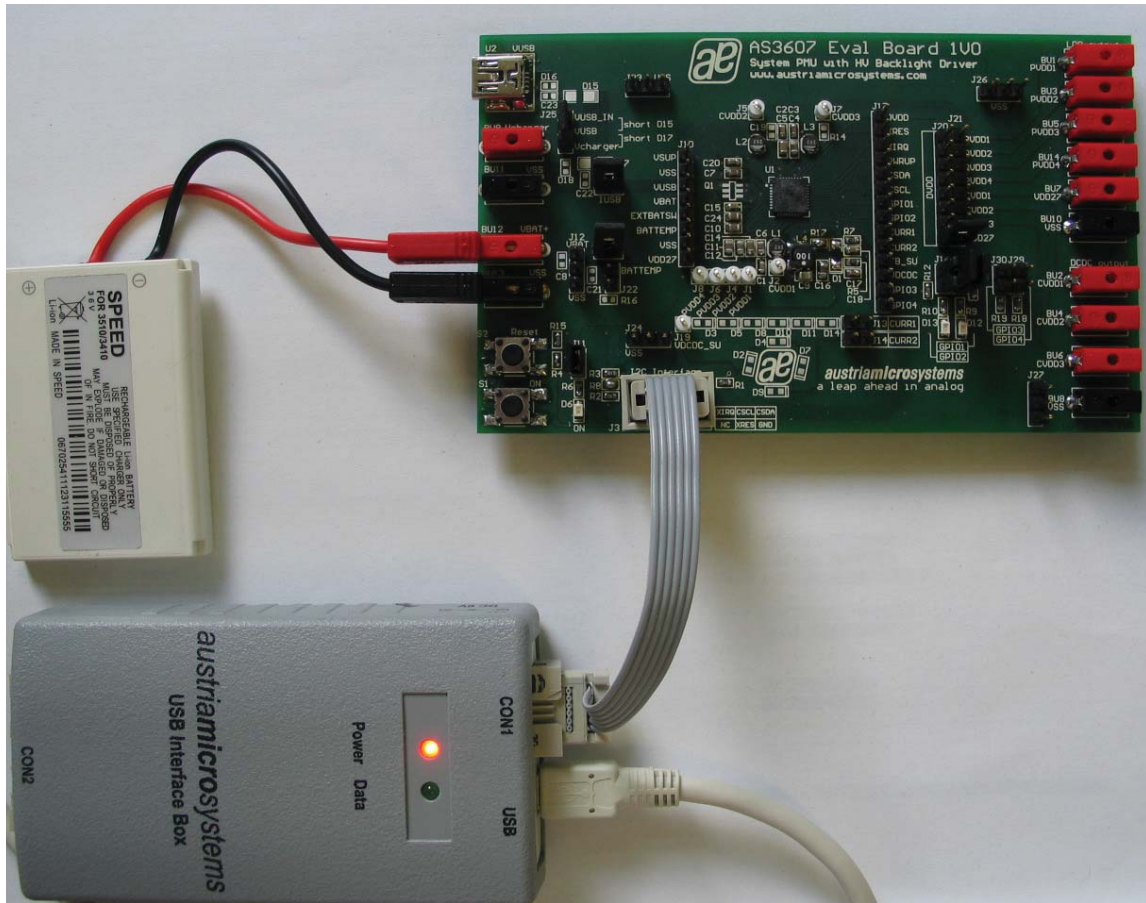

6.3 Starting the AS3607 Demo software

The correct installed demo software can be started from **Start > Programs > austriamicrosystems > AS3607 EvalSW**.

USB connection is immediately indicated in the status bar of the demo software.

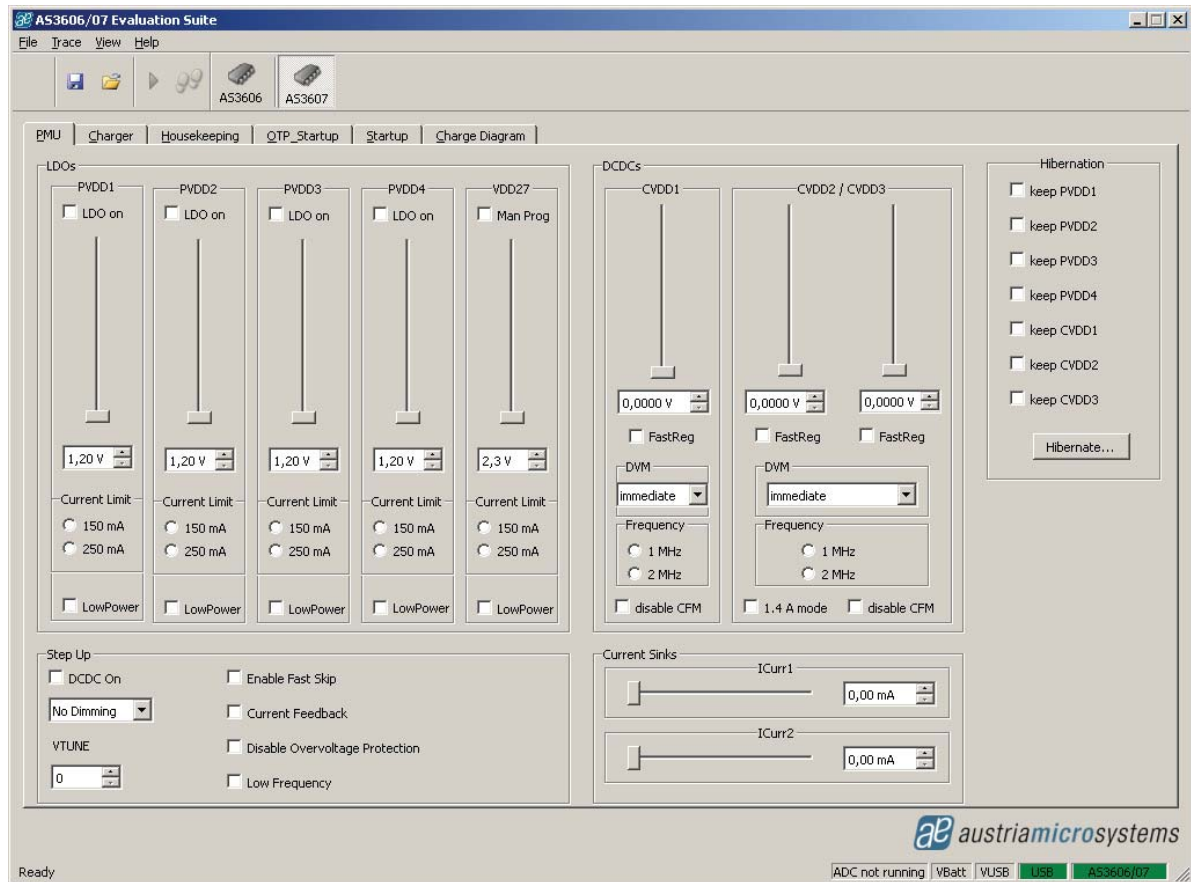

7 AS3607 Evalboard 1V0 connector and jumper locations

Listed below are the various connectors and jumpers.

Jumper	Function	comment
J1	PVDD1	measurement pinhead of LDO PVDD1
J2	CVDD1	measurement pinhead of DCDC CVDD1
J3	I2C Interface	USB-Box connector
J4	PVDD2	measurement pinhead of LDO PVDD2
J5	CVDD2	measurement pinhead of DCDC CVDD2
J6	PVDD3	measurement pinhead of LDO PVDD3
J7	CVDD3	measurement pinhead of DCDC CVDD3
J8	PVDD4	measurement pinhead of LDO PVDD4
J9	I USB	current measurement jumper of charge current
J10	measurement pinhead	
J11	ON LED	status LED connected to VDD27
J12	VBAT	Battery voltage measurement pinhead
J13	CURR1	current measurement jumper of CURR1
J14	CURR2	current measurement jumper of CURR2
J15	GPIO1	if set, LED D12 is connected to GPIO1
J16	GPIO2	if set, LED D13 is connected to GPIO2
J17	measurement pinhead	
J18	I BAT	current measurement jumper of battery current
J20	DVDD	DVDD can be supplied with one of the regulators; default: set to VDD27
J21	regulator output	DVDD can be supplied with one of the regulators; default: set to VDD27
J22	BATTEMP	
J23, J24, J26, J27	VSS	
J25	disable protection jumper	
J29, J30	GPIO3, GPIO4	if set, pull up resistor is connected to GPIO3/4
BU1 – BU7	LDO and DCDC converter output	
BU9	Charger input	Charger input: 2mm connector
U2	Charger input	Charger input: USB connector
B12	VBAT+	Battery connector
B13	VBAT-	Battery connector
B8, B10, B13	VSS	
S1	ON	ON button
S2	Reset	Reset button

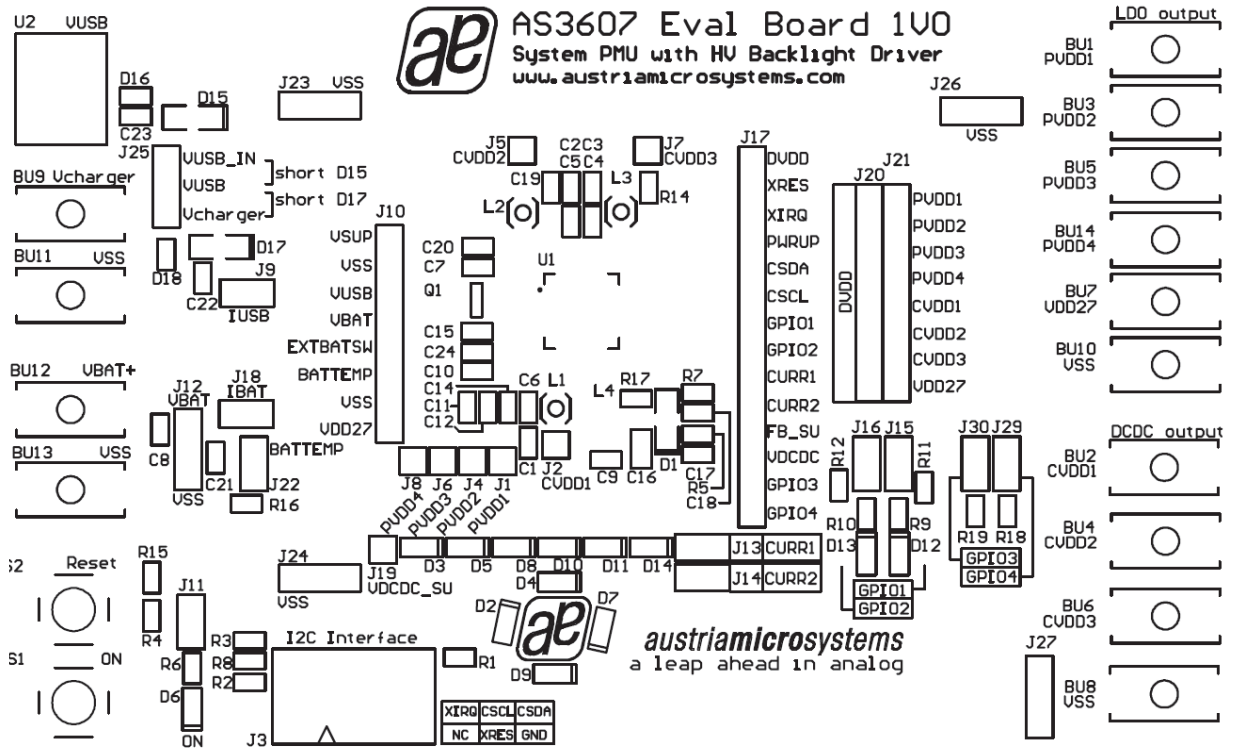

Connector and Jumper locations of AS3607 Eval Board 1V0

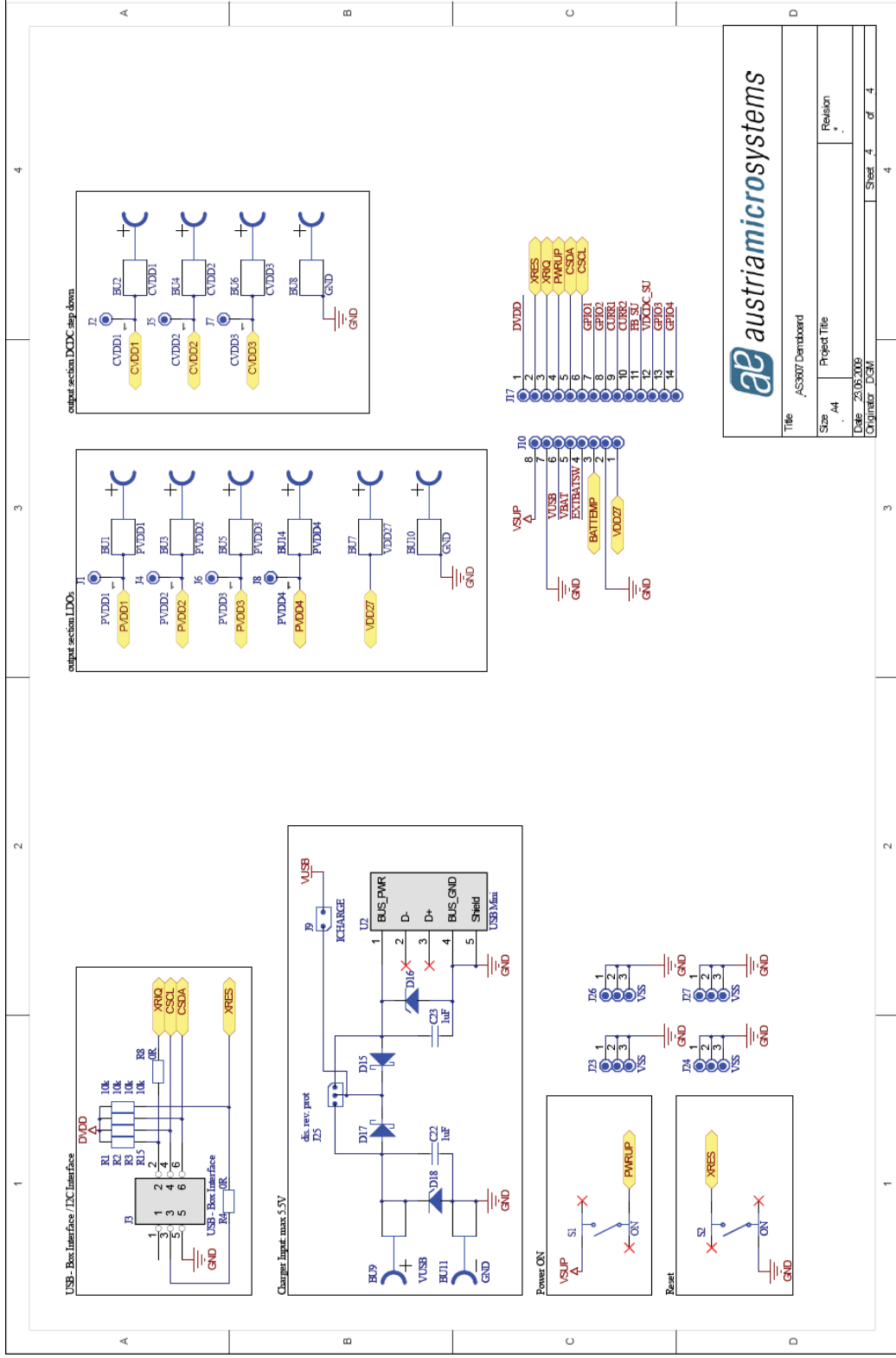

Application Schematic AS3607 Evalboard 1v0 - page2

austriamicrosystems

Title	AS3607 Databoard
Size	A4
Project Title	
Date	20.05.2009
Customer	DGM
Sheet	4 of 4

9 AS3607 Evalboard 1v0: Layout (top view)

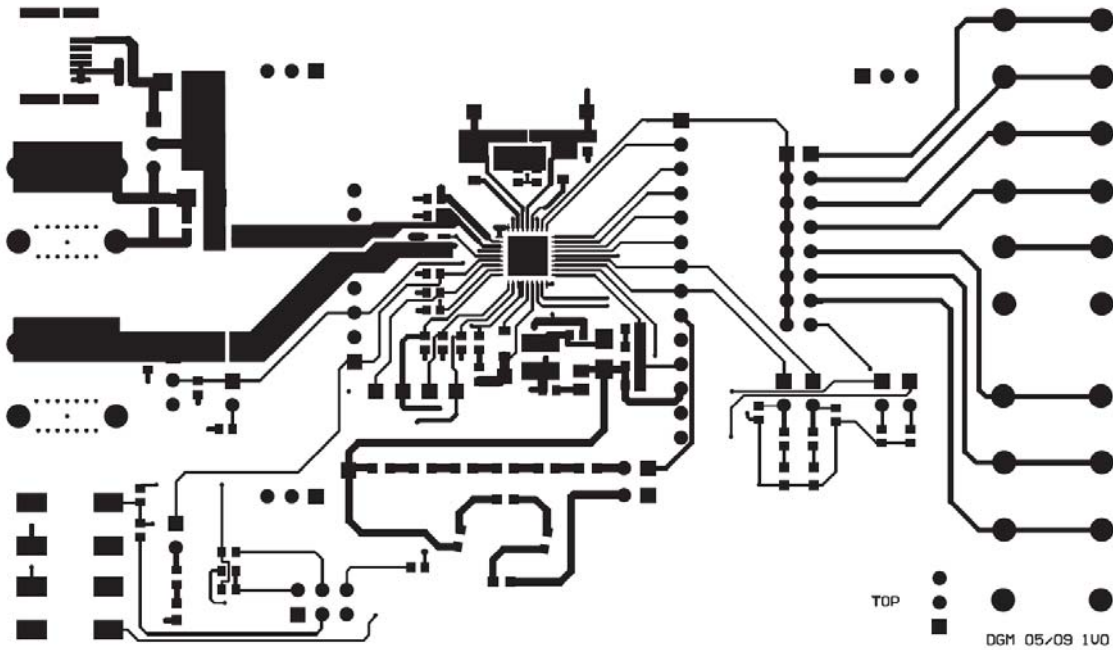

Layout (top view)

10 AS3607 Evalboard 1v0: Layout (mid layer 1)

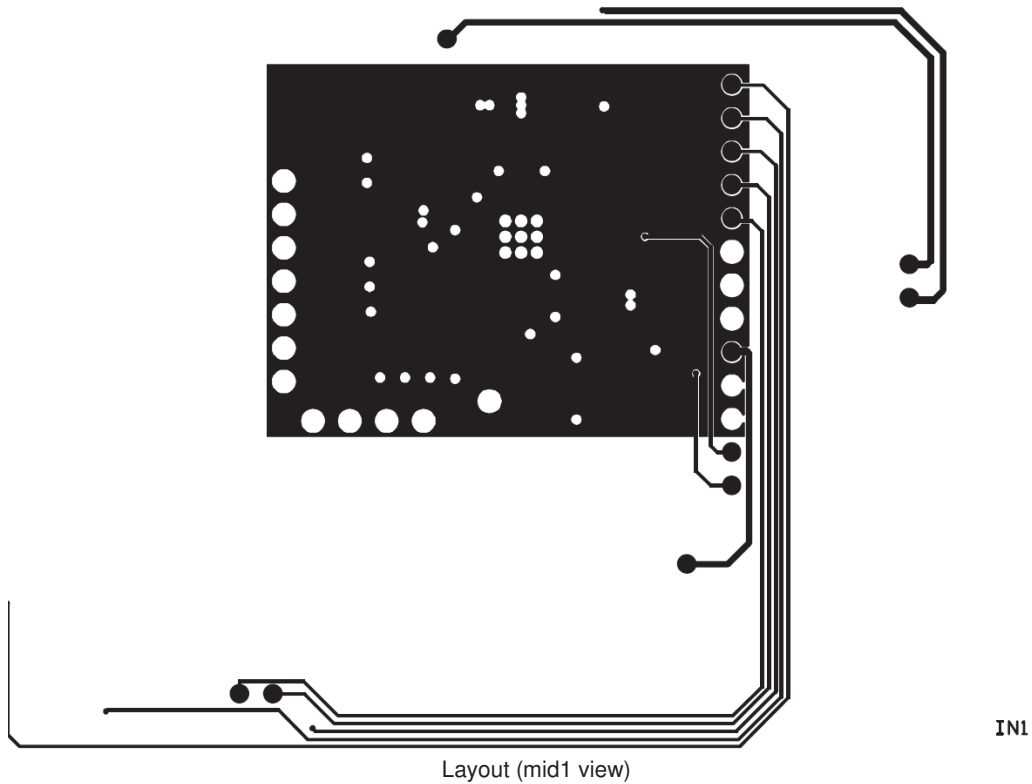

Layout (mid1 view)

11 AS3607 Evalboard 1v0: Layout (mid layer 2)

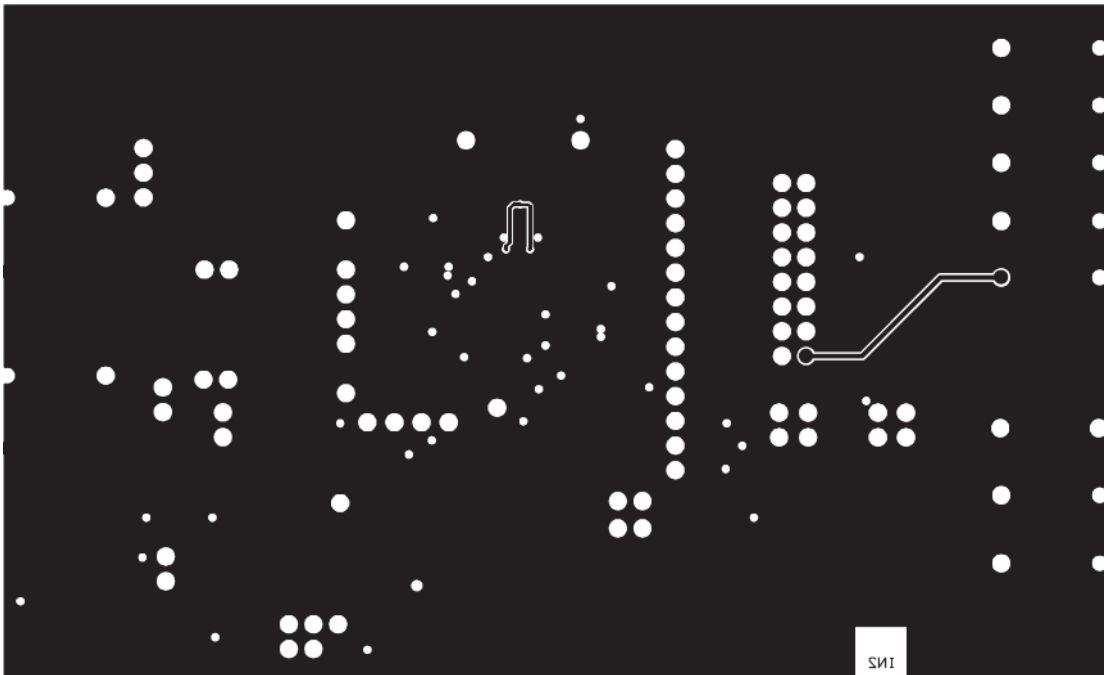

Layout (mid2 view)

12 AS3607 Evalboard 1v0: Layout (bottom view)

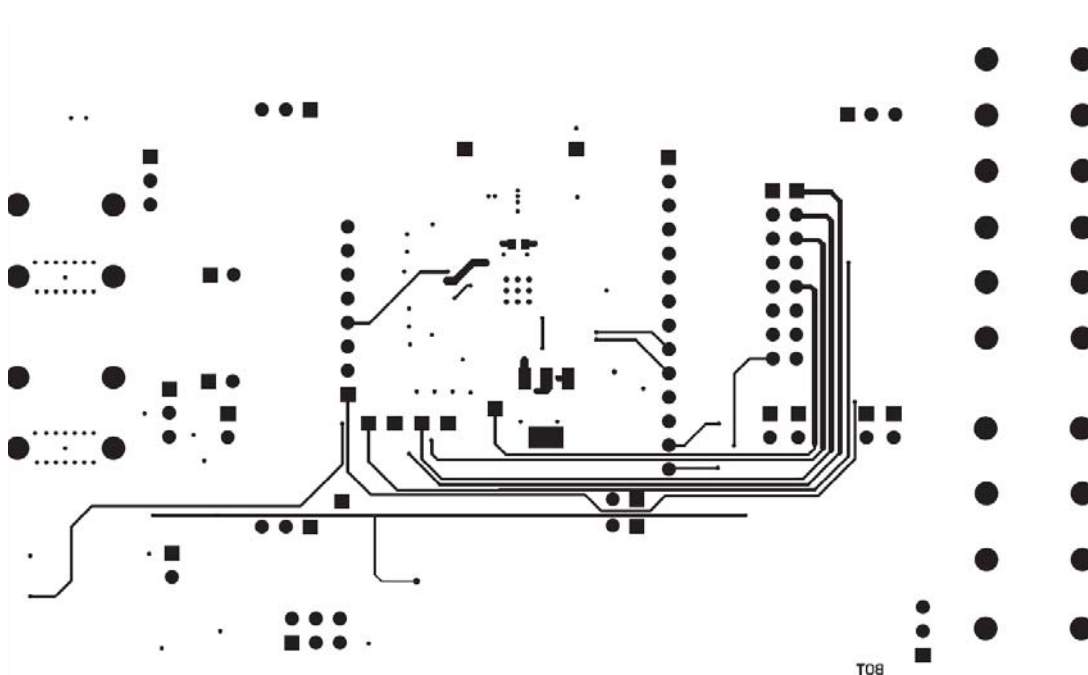

Layout (bottom view)

13 AS3606 Evalboard 1V1 connector and jumper locations

Listed below are the various connectors and jumpers.

Jumper	Function	comment
J1	PVDD1	measurement pinhead of LDO PVDD1
J2	CVDD1	measurement pinhead of DCDC CVDD1
J3	I2C Interface	USB-Box connector
J4	PVDD2	measurement pinhead of LDO PVDD2
J5	CVDD2	measurement pinhead of DCDC CVDD2
J6	PVDD3	measurement pinhead of LDO PVDD3
J7	CVDD3	measurement pinhead of DCDC CVDD3
J9	I USB	current measurement jumper of charge current
J10	measurement pinhead	
J11	ON LED	status LED connected to VDD27
J12	VBAT	Battery voltage measurement pinhead
J13	CURR1	current measurement jumper of CURR1
J14	CURR2	current measurement jumper of CURR2
J15	GPIO1	if set, LED D12 is connected to GPIO1
J16	GPIO2	if set, LED D13 is connected to GPIO2
J17	measurement pinhead	
J18	I BAT	current measurement jumper of battery current
J20	DVDD	DVDD can be supplied with one of the regulators; default: set to VDD27
J21	regulator output	DVDD can be supplied with one of the regulators; default: set to VDD27
J22	BATTEMP	
J23, J24, J26,J8	VSS	
J25	disable protection jumper	
BU1 – BU7	LDO and DCDC converter output	
BU9	Charger input	Charger input: 2mm connector
U2	Charger input	Charger input: USB connector
B12	VBAT+	Battery connector
B13	VBAT-	Battery connector
B8,B10, B11	VSS	
S1	ON	ON button
S2	Reset	Reset button

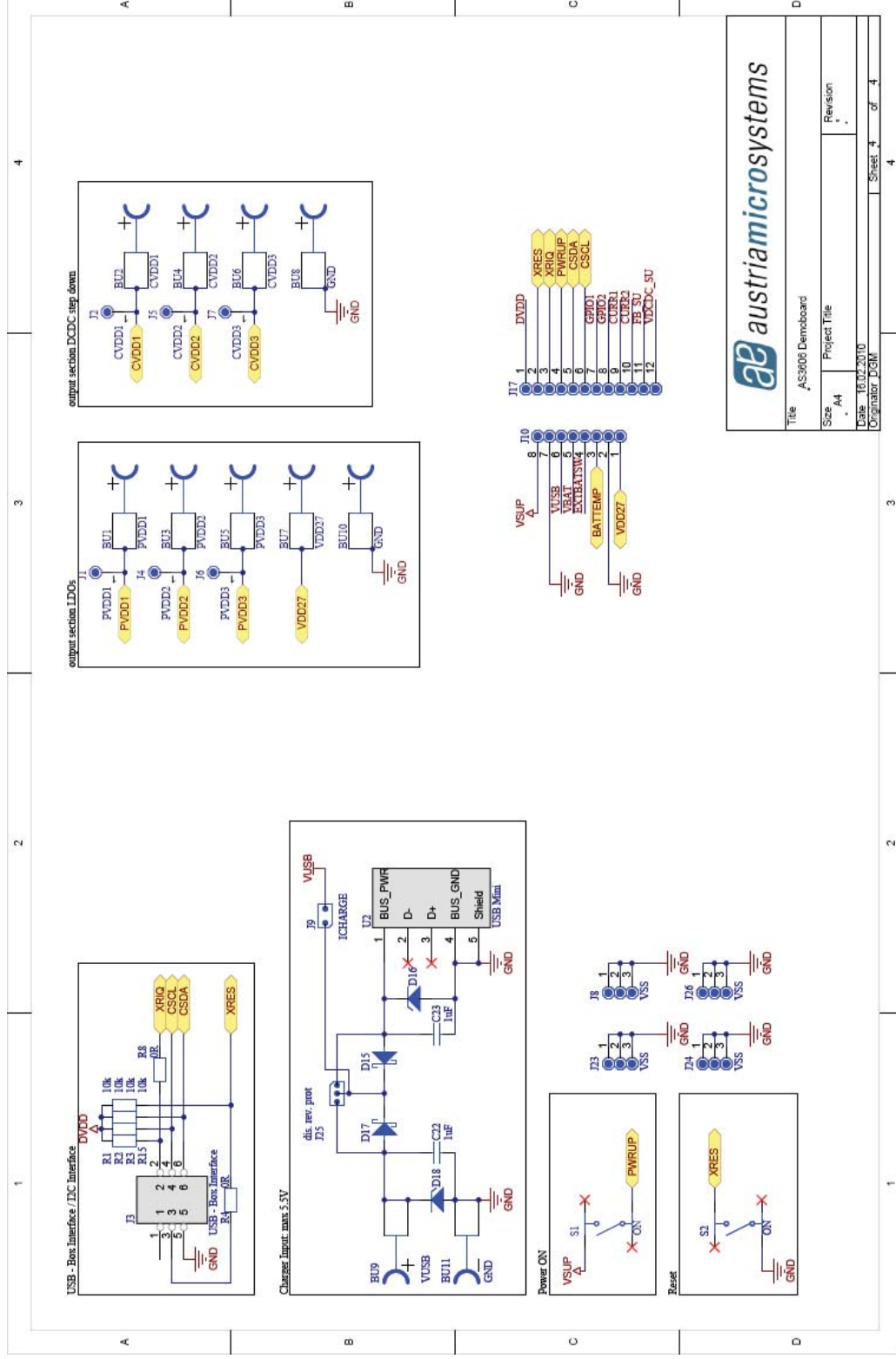

15 AS3606 Evalboard 1v1: Layout (top view)

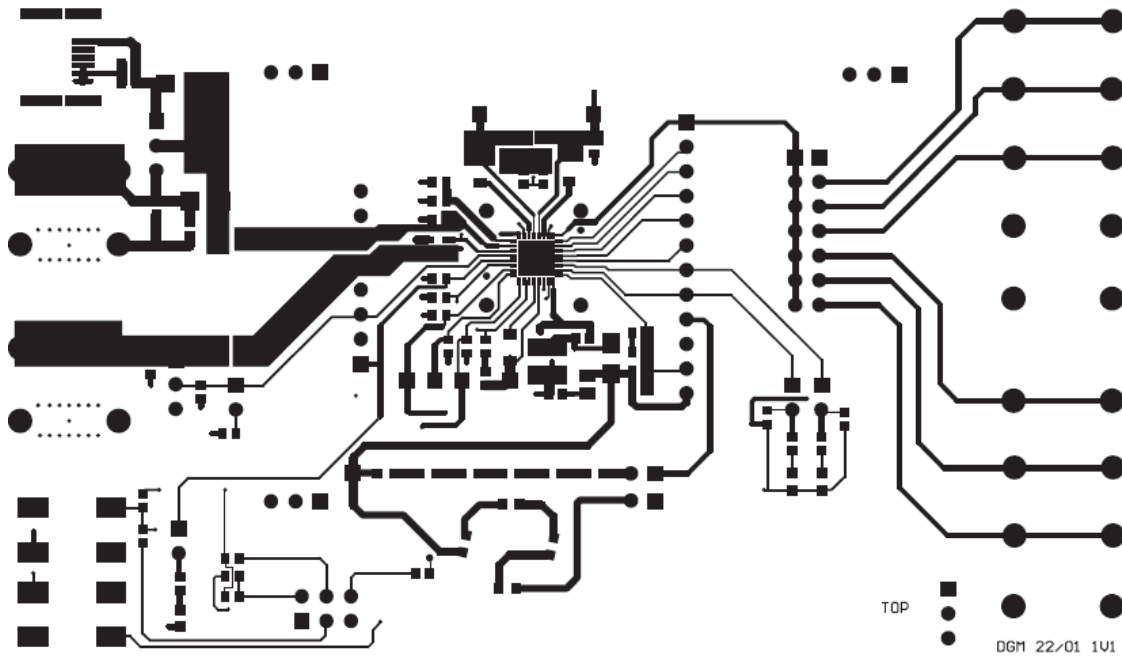

Layout (top view)

16 AS3606 Evalboard 1v1: Layout (mid layer 1)

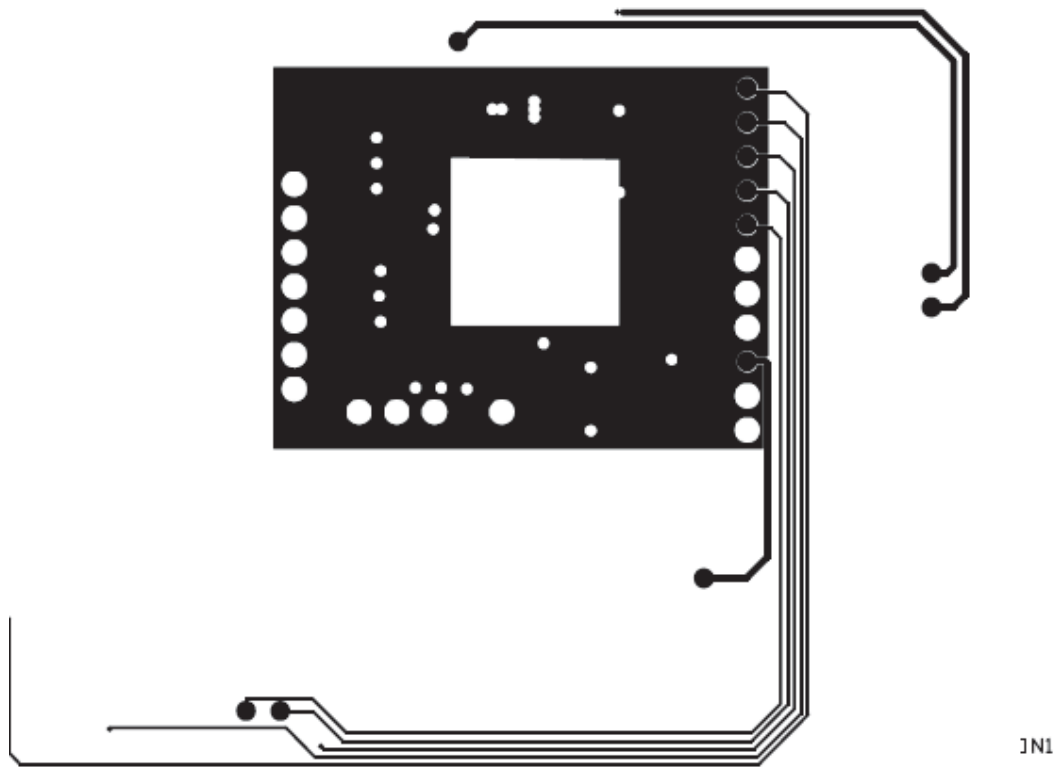

Layout (mid1 view)

17 AS3606 Evalboard 1v1: Layout (mid layer 2)

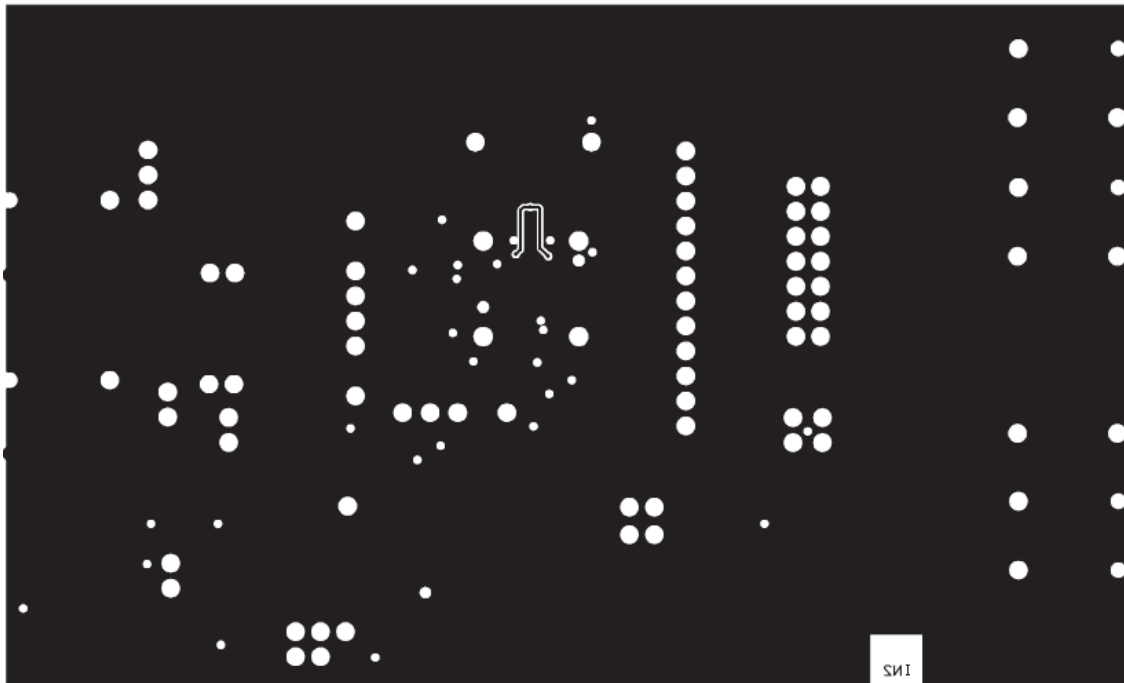

Layout (mid2 view)

18 AS3606 Evalboard 1v1: Layout (bottom view)

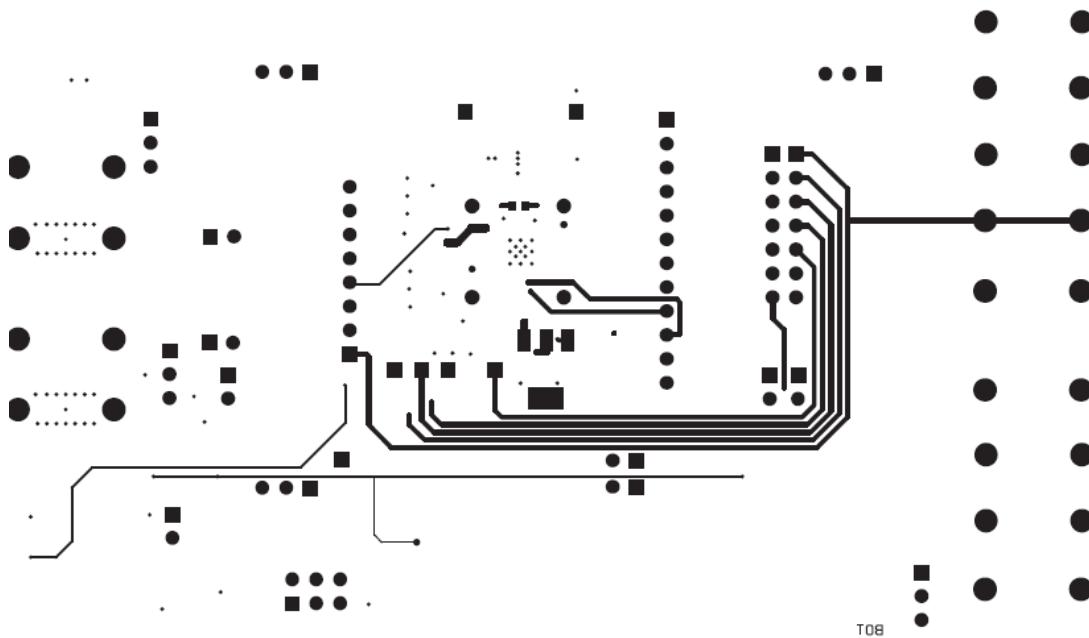

Layout (bottom view)

Copyright

Copyright © 1997-2009, austriamicrosystems AG, Schloss Premstaetten, 8141 Unterpremstaetten, Austria-Europe. Trademarks Registered ®. All rights reserved. The material herein may not be reproduced, adapted, merged, translated, stored, or used without the prior written consent of the copyright owner.

All products and companies mentioned are trademarks or registered trademarks of their respective companies.

Disclaimer

Devices sold by austriamicrosystems AG are covered by the warranty and patent indemnification provisions appearing in its Term of Sale. austriamicrosystems AG makes no warranty, express, statutory, implied, or by description regarding the information set forth herein or regarding the freedom of the described devices from patent infringement. Austriamicrosystems AG reserves the right to change specifications and prices at any time and without notice. Therefore, prior to designing this product into a system, it is necessary to check with austriamicrosystems AG for current information.

This product is intended for use in normal commercial applications. Applications requiring extended temperature range, unusual environmental requirements, or high reliability applications, such as military, medical life-support or lifesustaining equipment are specifically not recommended without additional processing by austriamicrosystems AG for each application. For shipments of less than 100 parts the manufacturing flow might show deviations from the standard production flow, such as test flow or test location.

The information furnished here by austriamicrosystems AG is believed to be correct and accurate. However, austriamicrosystems AG shall not be liable to recipient or any third party for any damages, including but not limited to personal injury, property damage, loss of profits, loss of use, interruption of business or indirect, special, incidental or consequential damages, of any kind, in connection with or arising out of the furnishing, performance or use of the technical data herein. No obligation or liability to recipient or any third party shall arise or flow out of austriamicrosystems AG rendering of technical or other services.



Contact Information

Headquarters

austriamicrosystems AG
A-8141 Schloss Premstätten, Austria
T. +43 (0) 3136 500 0
F. +43 (0) 3136 5692

For Sales Offices, Distributors and Representatives, please visit:
<http://www.austriamicrosystems.com/contact>

Looking for pricing, stock, or lifecycle information?

Click below to explore more details on WIN SOURCE:

⊖ View [AS3607 EVAL BOARD](#) on WIN SOURCE

⊖ [ams](#) Information

Optimize Your Supply Chain with WIN SOURCE Solutions

- ✓ Global Sourcing Solution
- ✓ Obsolete Management
- ✓ Cost Control Management
- ✓ Shortage Management
- ✓ Alternative Solution
- ✓ Excess Inventory Management