

AN1433SSM

High accuracy, variable output, low voltage operation shunt regulator

■ Overview

The AN1433SSM is a low voltage operation and highly accurate positive voltage variable output type shunt regulator IC. Since the output voltage is adjustable from approximately 1.25 V to 15 V, it is suitable for a power supply of small-sized 3 V-system portable equipment. Also, it contributes to the miniaturization of set equipment by the adoption of the small type surface mounting package.

■ Features

- Highly accurate reference voltage: 1.25 V (allowance: $\pm 1\%$)
- Low voltage operation: 1.25 V to 14 V
- Small type surface mounting package

■ Applications

- Cellular phone, PHS, office automation equipment and other small-sized portable equipment

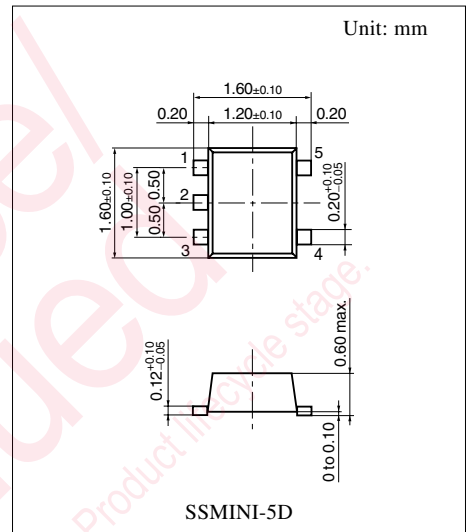

Note) The package of this product will be changed to lead-free type (SSMINI-5DA). See the new package dimensions section later of this datasheet.

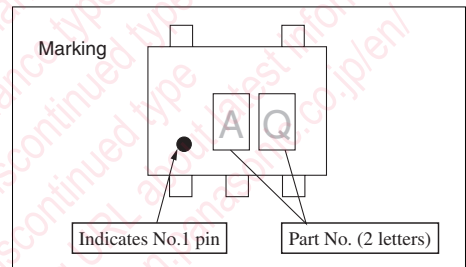

■ Block Diagram

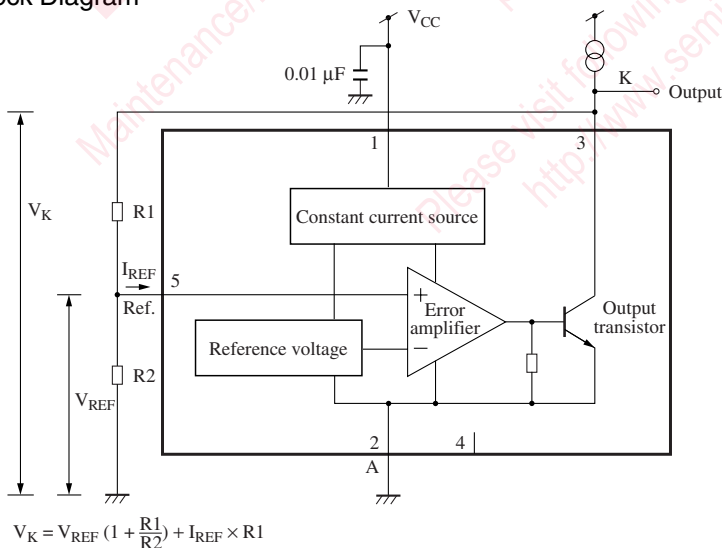

■ Pin Descriptions

Pin No.	Description	
1	V_{CC}	Power source current supply pin.
2	Anode	The reference voltage pin for the constant voltage of this shunt regulator IC. The current from V_{CC} , cathode and reference flow out from this pin.
3	K: Cathode	The constant voltage output pin of this shunt regulator. The supplied current more than necessary to this pin is bypassed to anode pin by the output transistor.
4	N.C.	Nothing is connected to this pin. If high voltage is applied, the characteristics of the IC may be affected.
5	Reference	The reference voltage (1.25 V typical) pin. Although the impedance is high under the normal using conditions, be careful that the impedance drops and current flows into the IC inside if a current or voltage is forced to apply from the outside.

■ Absolute Maximum Ratings

Parameter	Symbol	Rating	Unit
Cathode voltage	V_K	14.2	V
Reference voltage	V_{REF}	7	V
Supply current	I_K	1.5	mA
Reference current	I_{REF}	50	μ A
Cathode-anode reverse current	$-I_{KA}$	-10	mA
Cathode-reference reverse current	$-I_{KR}$	-10	mA
Cathode current	I_K	20	mA
Power dissipation ^{*2}	P_D	50	mW
Operating ambient temperature ^{*1}	T_{opr}	-30 to +85	$^{\circ}$ C
Storage temperature ^{*1}	T_{stg}	-55 to +150	$^{\circ}$ C

Note) 1. Do not apply external currents or voltages to any pins not specifically mentioned.

For circuit currents, '+' denotes current flowing into the IC and '-' denotes current flowing out of the IC.

2. *1: Except for the power dissipation, operating ambient temperature and storage temperature, all ratings are for $T_a = 25^{\circ}$ C.

*2: The value at $T_a = 85^{\circ}$ C.

■ Recommended Operating Range

Parameter	Symbol	Range	Unit
Supply voltage	V_{CC}	V_{REF} to 14	V

■ Electrical Characteristics at $V_{CC} = 1.8\text{ V}$, $T_a = 25^\circ\text{C}$

Parameter	Symbol	Conditions	Min	Typ	Max	Unit
Reference voltage	V_{REF}	$I_K = 10\text{ mA}$	1.2375	1.25	1.2625	V
Reference voltage supply voltage fluctuation	$\frac{\Delta V_{REF}}{\Delta V_{CC}}$	$1.7\text{ V} \leq V_{CC} \leq 14.0\text{ V}$, $I_K = 10\text{ mA}$	—	-0.73	-1.5	mV/V
Reference voltage cathode current fluctuation	$\frac{\Delta V_{REF}}{\Delta I_K}$	$0.2\text{ mA} \leq I_K \leq 20\text{ mA}$	—	0.04	0.3	mV/mA
Reference input current	I_{REF}	$R_1 = 10\text{ k}\Omega$, $I_K = 10\text{ mA}$	—	4.0	10	μA
Minimum cathode current	$I_{K\text{ min}}$	$V_K = V_{REF}$	—	—	0.2	mA
Off time total current	I_{OFF}	$V_K = 14.0\text{ V}$, $V_{REF} = 0\text{ V}$	—	—	1	μA
Cathode saturation voltage	$V_{K\text{ sat}}$	$I_K = 10\text{ mA}$, $V_{REF} = 1.3\text{ V}$	—	0.08	0.15	V
Supply current	ICC	$I_K = 10\text{ mA}$	—	0.75	1.50	mA

• Design reference data

Note) The characteristics listed below are theoretical values based on the IC design and are not guaranteed.

Parameter	Symbol	Conditions	Reference value	Unit
Reference voltage change with temperature	$\frac{\Delta V_{REF}}{\Delta T_a}$	$V_{KA} = V_{REF}$, $I_{KA} = 10\text{ mA}$ $0^\circ\text{C} \leq T_a \leq +70^\circ\text{C}$	3	mV
Reference input current change with temperature	$\frac{\Delta I_{REF}}{\Delta T_a}$	$R_1 = 10\text{ k}\Omega$, $I_K = 10\text{ mA}$ $0^\circ\text{C} \leq T_a \leq +70^\circ\text{C}$	1.1	mA

■ Application Notes

1. $P_D - T_a$ curves of SSMINI-5D package

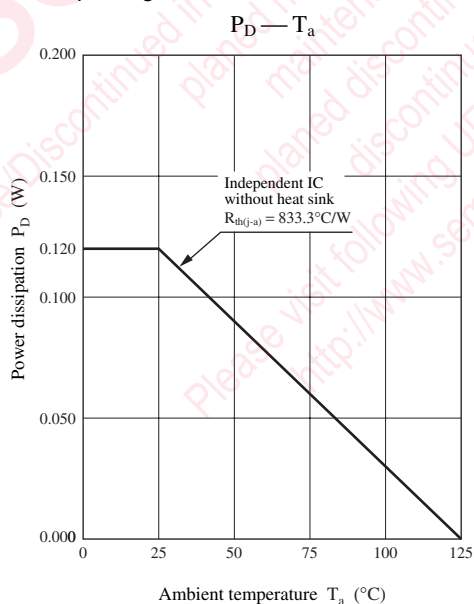

Application Notes (continued)

2. Main Characteristics

Supply current

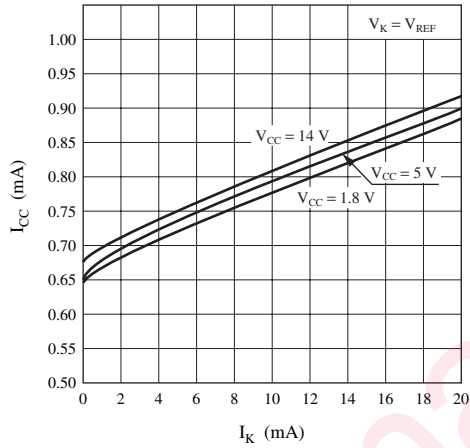

Reference input current

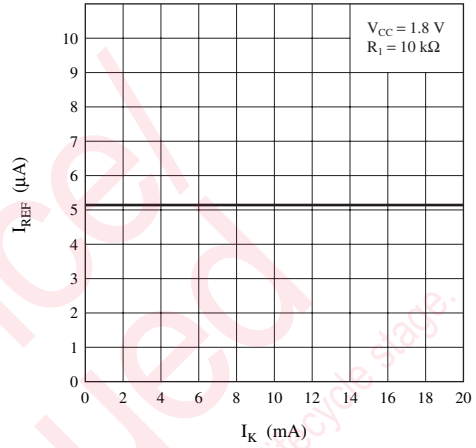

Reference voltage (temperature characteristics)

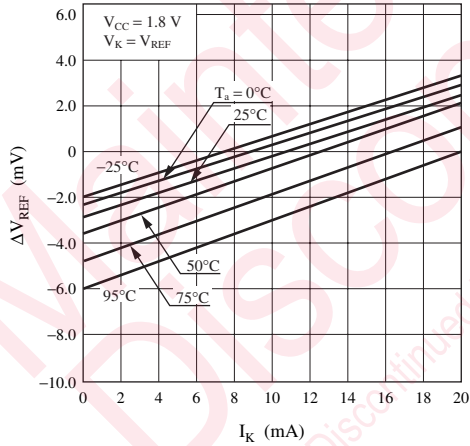

Reference current (temperature characteristics)

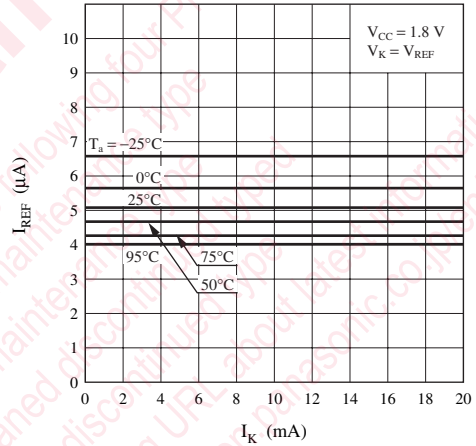

Reference voltage supply voltage fluctuation

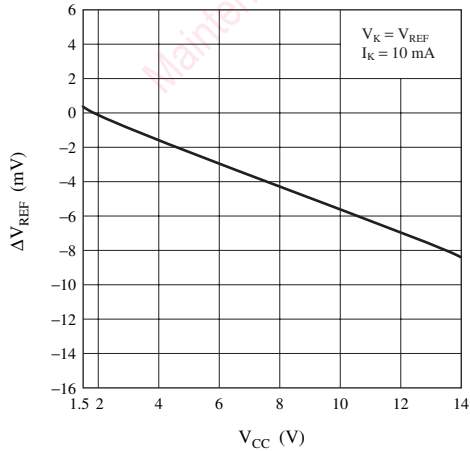

Reference voltage cathode current fluctuation

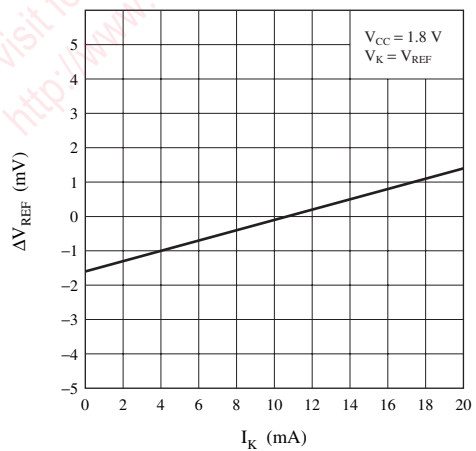

■ Application Notes (continued)

2. Main Characteristics (continued)

V_{REF} temperature characteristic

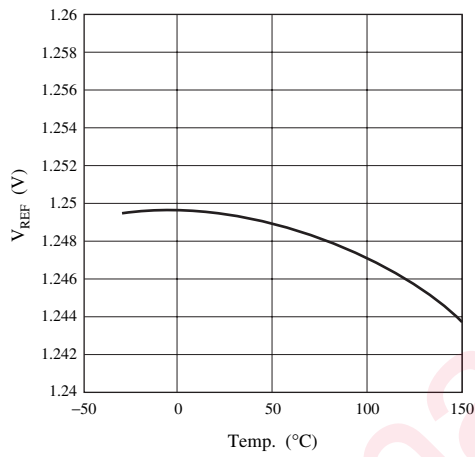

Cathode saturation voltage

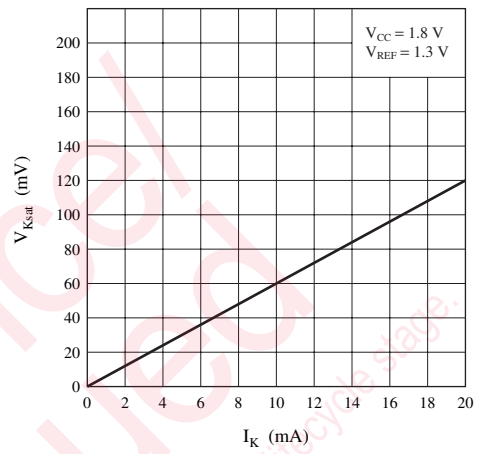

Minimum cathode current

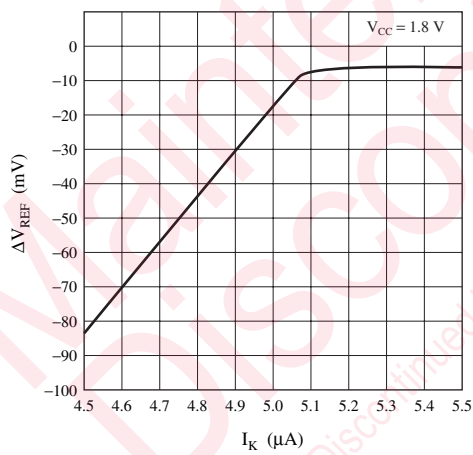

■ Application Circuit Example

This circuit amplifies the error voltage of the secondary side output voltage in the insulation type switching power supply, then transfers it to the primary side via a photocoupler.

Replaceable with the conventional products (AN1431M, AN1431T, AN1432MS).

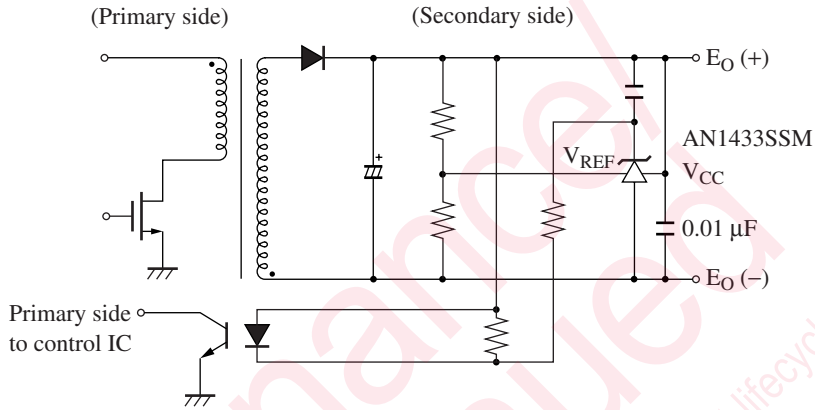

Note) As V_{CC} and cathode pin are separated, V_K can operate till $0.15 V_{max}$ (at $I_K = 10 \text{ mA}$) at least.

■ New Package Dimensions (Unit: mm)

- SSMINI-5DA (Lead-free package)

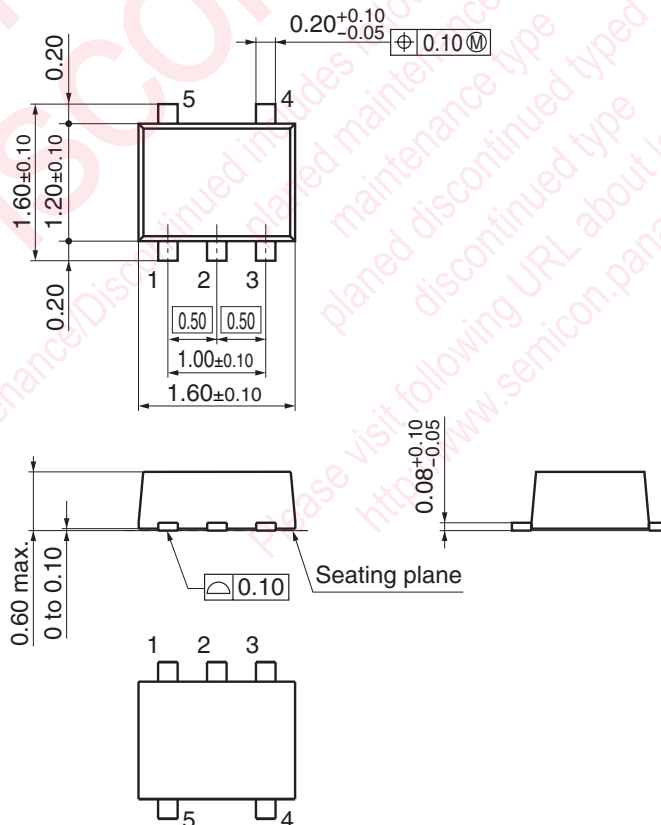

utions in using the technical information and scribed in this book

s book is to be exported or provided to non-residents, the laws and
rd to security export control, must be observed.

ly to show the main characteristics and application circuit examples
l property right or other right owned by our company or any other
any as to the infringement upon any such right owned by any other
rmation described in this book.

standard applications or general electronic equipment (such as office
and household appliances).

ng applications:

biles, traffic control equipment, combustion equipment, life support
reliability are required, or if the failure or malfunction of the prod-

ck are subject to change without notice for modification and/or im-
use of the products, therefore, ask for the most up-to-date Product
atisfy your requirements.

bsolute maximum rating and the guaranteed operating conditions
(.). Especially, please be careful not to exceed the range of absolute
er-off and mode-switching. Otherwise, we will not be liable for any

take into the consideration of incidence of break down and failure
n the systems such as redundant design, arresting the spread of fire
al injury, fire, social damages, for example, by using the products.

own and characteristics change due to external factors (ESD, EOS,
mounting or at customer's process. When using products for which
shelf life and the elapsed time since first opening the packages.

ly or partially, without the prior written permission of Matsushita

Looking for pricing, stock, or lifecycle information?

Click below to explore more details on WIN SOURCE:

 [View AN1433SSMTXL on WIN SOURCE](#)

 [Panasonic Information](#)

Optimize Your Supply Chain with WIN SOURCE Solutions

-  Global Sourcing Solution
-  Obsolete Management
-  Cost Control Management
-  Shortage Management
-  Alternative Solution
-  Excess Inventory Management