

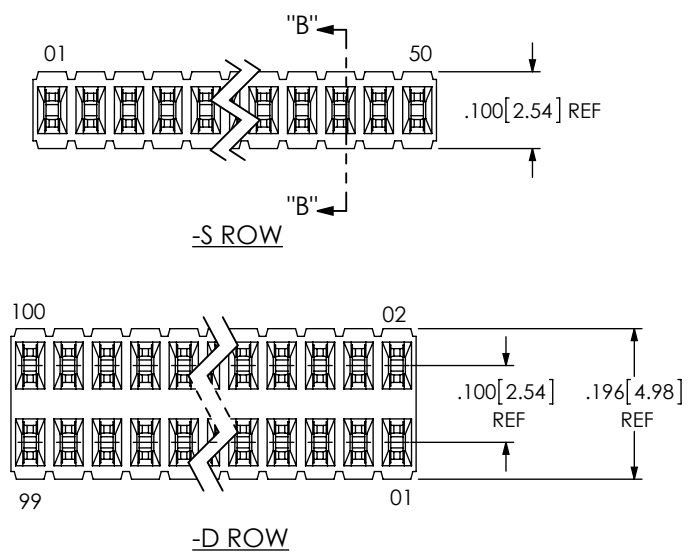

**THE DATASHEET OF
SLM-105-01-S-D**



SLM-1XX-01-X-X



No OF POSITIONS
-01 THRU -50 (PER ROW)
LEAD STYLE
-01: USE C-29-X

BODY SPECIFICATION
-S: SINGLE (USE SLM-50-S)
-D: DOUBLE (USE SLM-50-D)

PLATING SPECIFICATION
-G: 20µ" GOLD IN CONTACT AREA,
3µ" GOLD ON TAIL
-T: MATTE TIN CONTACT AND TAIL
-L: 10µ" SELECTIVE GOLD IN CONTACT AREA,
MATTE TIN ON TAIL
-S: 30µ" SELECTIVE GOLD IN CONTACT AREA,
MATTE TIN ON TAIL
-F: 3µ" FLASH SELECTIVE GOLD IN CONTACT AREA,
MATTE TIN ON TAIL
-H: 30µ" HEAVY GOLD IN CONTACT AREA,
3µ" GOLD ON TAIL

PACKAGING TABLE		
ROW SPEC	TUBES *	PLUG
-D: DOUBLE	PT-1-24-03-09	TP-09
-S: SINGLE	PT-1-24-01-12	TP-12

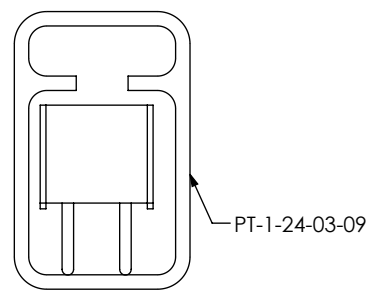
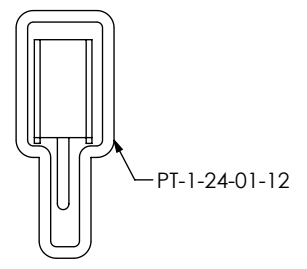
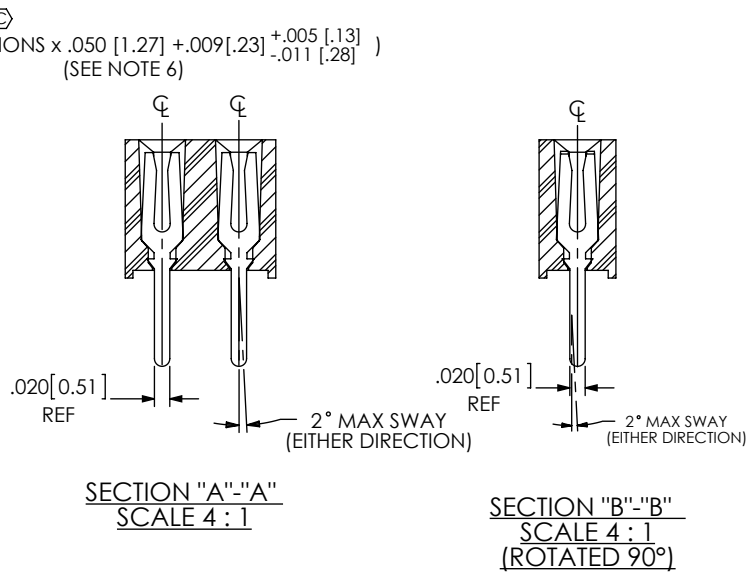
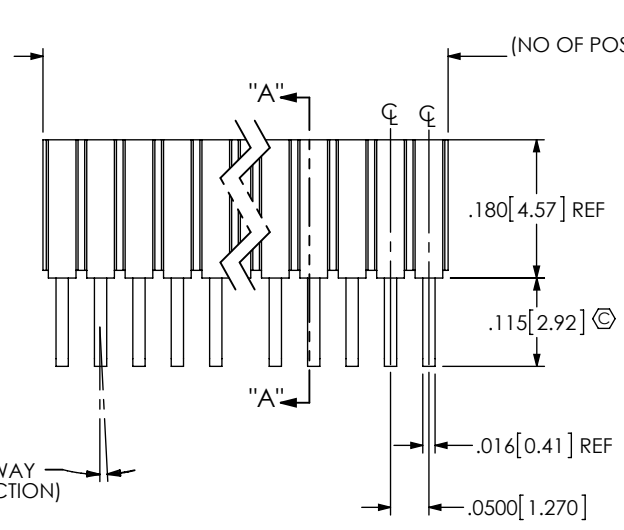

PACKAGING VIEW

- NOTES:
1. REPRESENTS A CRITICAL DIMENSION.
 2. MAXIMUM CUT FLASH: .010 [.25]
 3. MINIMUM PUSHOUT FORCE: 1 LBS.
 4. MAXIMUM ALLOWABLE BOW: .005 IN/IN [.013 MM/MM] (NO FLASH ALLOWED IN HOLES).
 5. TUBE ONLY -05 THRU -50 POSITIONS. POSITIONS -01 THRU -04 TO BE BULK PACKAGED.
 6. ADDER OF .009 ONLY REQUIRED FOR CUT TO POSITIONS LENGTHS.

UNLESS OTHERWISE SPECIFIED, DIMENSIONS ARE IN INCHES.
TOLERANCES ARE:
DECIMALS ANGLES
.X: ±.1 [2.5]
.XX: ±.01 [.3] 2°
.XXX: ±.005 [.13]
.XXXX: ±.0020 [.051]

PROPRIETARY NOTE
THIS DOCUMENT CONTAINS INFORMATION CONFIDENTIAL AND PROPRIETARY TO SAMTEC, INC. AND SHALL NOT BE REPRODUCED OR TRANSFERRED TO OTHER DOCUMENTS OR DISCLOSED TO OTHERS OR USED FOR ANY PURPOSE OTHER THAN THAT WHICH IT WAS OBTAINED WITHOUT THE EXPRESSED WRITTEN CONSENT OF SAMTEC, INC.



DO NOT SCALE DRAWING SHEET SCALE: 2:1
F:\DWG\MISC\MKTG\SLM-1XX-01-X-X-MKT.SLDDRW

520 PARK EAST BLVD., NEW ALBANY, IN 47150
PHONE: 812-944-6733 FAX: 812-948-5047
e-Mail: info@SAMTEC.com code 55322

DESCRIPTION:
LOW PROFILE .050 [1.27] SOCKET STRIP ASM.
DWG. NO.
SLM-1XX-01-X-X
BY:KOLB 1/25/89 SHEET 1 OF 1

Looking for pricing, stock, or lifecycle information?

Click below to explore more details on WIN SOURCE:

-  [View SLM-105-01-S-D on WIN SOURCE](#)
-  [Samtec Inc. Information](#)

Optimize Your Supply Chain with WIN SOURCE Solutions

-  Global Sourcing Solution
-  Obsolete Management
-  Cost Control Management
-  Shortage Management
-  Alternative Solution
-  Excess Inventory Management