



**THE DATASHEET OF
APAM1866YA18**



GPS Active Internal Patch

APAM1866YA18

RoHS/RoHS II compliant

MSL level: N/A

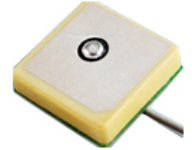

18.0 x 18.0 x 7.0mm

FEATURES:

- Compact Size
- Easy to Install
- RoHS Compliant

TYPICAL APPLICATIONS:

- Automotive Navigation, Marine buoys
- Personal Tracking
- Surveying equipment, Cell phone, Laptop
- Healthcare and medical monitoring devices, PND, PDA

STANDARD SPECIFICATIONS:

Antenna

Parameters	Min.	Typ.	Max.	Units	Note
Center Frequency	1575.42± 1.023			MHz	
Bandwidth	8			MHz	
Gain		2.5		dBic	(Peak gain on 70*70mm Ground Plane facing Zenith.)
VSWR @ Center Frequency		2.0			
Polarization Model	RHCP				(Right Hand Circular Polarization)
Impedance	50			Ω	
Working Temperature	-40		+85	°C	
Storage Temperature	-40		+85	°C	

Low Noise Amplifier (LNA)

Parameters	Min.	Typ.	Max.	Units	Note
Center Frequency	1575.42± 1.023			MHz	
DC Voltage	2.70	3.0	3.30	V	
Gain	24	27	30	dB	(Without cable +25°C± 10°C)
Output VSWR			2.0		
Noise Figure			2.0	dB	
DC current	11	13	15	mA	(At 3.0V)
Outband Rejection (Absolute value)	20			dB	f0 + 100 MHz
	30			dB	f0 - 100 MHz

SMITH CHART

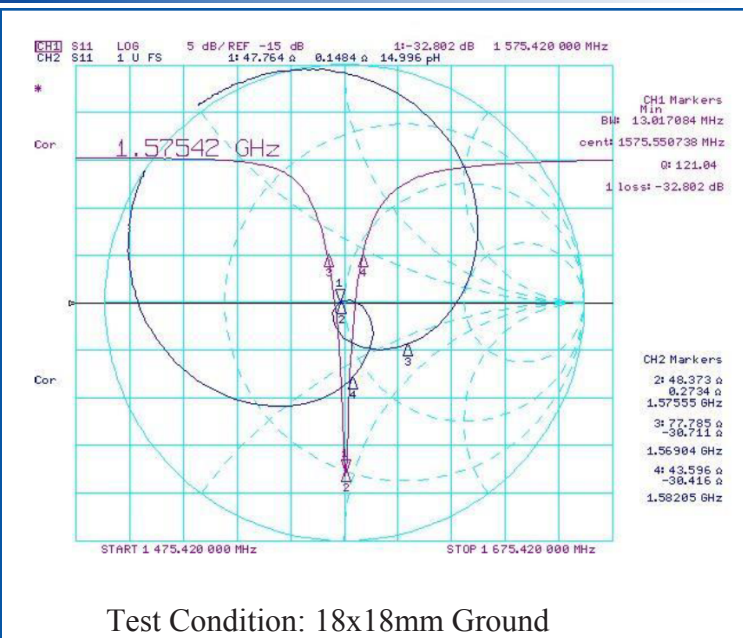

GPS LNA GAIN PLOT

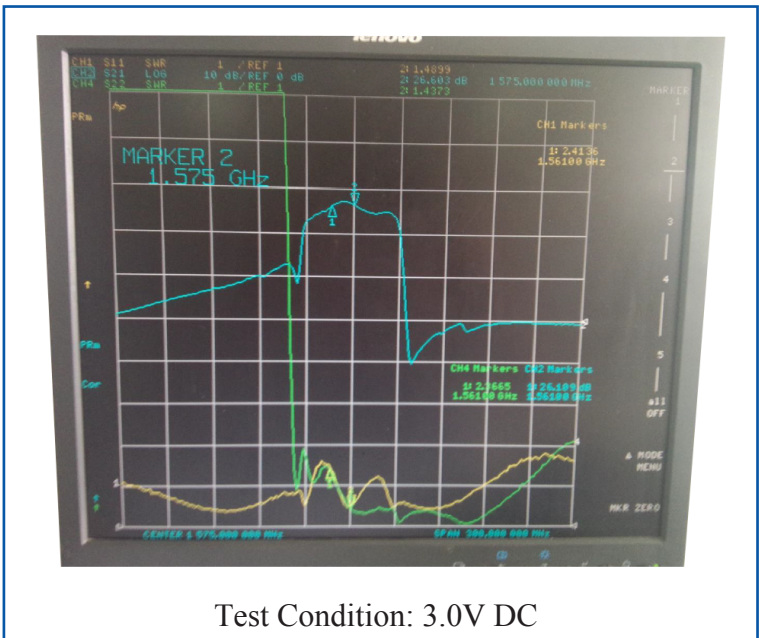

REVISED: 08.03.2018



5101 Hidden Creek Ln Spicewood TX 78669
 Phone: 512-371-6159 | Fax: 512-351-8858
 For terms and conditions of sales, please visit:
www.abracon.com

ABRACON IS
 ISO9001-2015
 CERTIFIED

GPS Active Internal Patch

APAM1866YA18

RoHS/RoHS II compliant

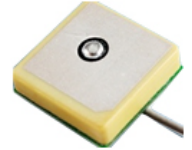

18.0 x 18.0 x 7.0mm

OUTLINE DIMENSION:

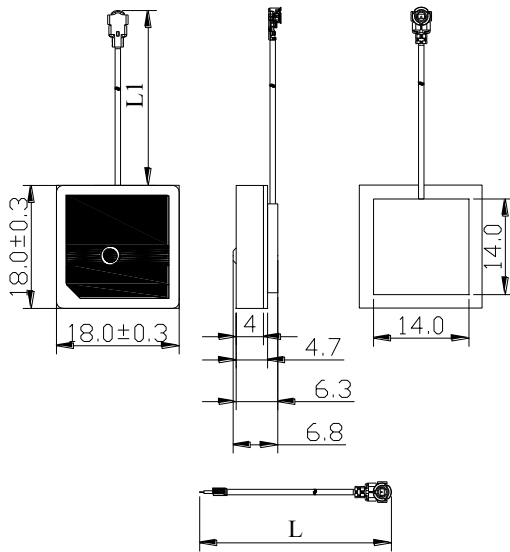

Description	Material
Antenna Type	Dielectric Ceramics
PCB	FR4
Shielding	Tinplate
RF Cable	φ1.13±0.1mm, L1=200mm±3mm, L=205mm±3mm
RF Connector	I-PEX

Tolerance: ±0.2mm

Unit: mm

PACKAGING

Package Type	Quantity
MOQ	150 pcs
Tray	30 pcs/tray
Vacuum Bag	5 tray per Vacuum bag (150pcs per bag)
Outer Box	4 bags = 600 pcs/carton

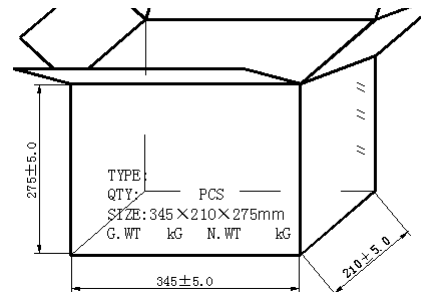
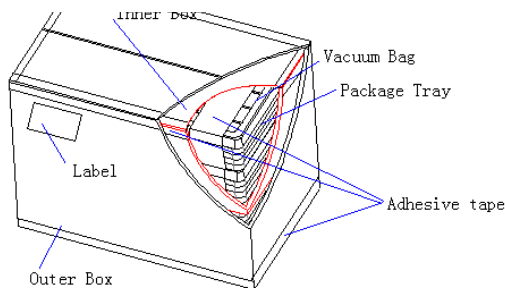
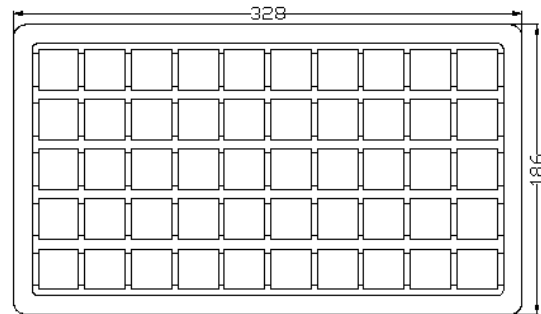

ATTENTION: Abracon LLC's products are COTS – Commercial-Off-The-Shelf products; suitable for Commercial, Industrial and, where designated, Automotive Applications. Abracon's products are not specifically designed for Military, Aviation, Aerospace, Life-dependant Medical applications or any application requiring high reliability where component failure could result in loss of life and/or property. For applications requiring high reliability and/or presenting an extreme operating environment, written consent and authorization from Abracon LLC is required. Please contact Abracon LLC for more information.

Looking for pricing, stock, or lifecycle information?

Click below to explore more details on WIN SOURCE:

 [View APAM1866YA18 on WIN SOURCE](#)

 [Abracon LLC Information](#)

Optimize Your Supply Chain with WIN SOURCE Solutions

-  Global Sourcing Solution
-  Obsolete Management
-  Cost Control Management
-  Shortage Management
-  Alternative Solution
-  Excess Inventory Management