

NON-SHIELDED
(8 POSITION, 8 CONTACTS SHOWN)

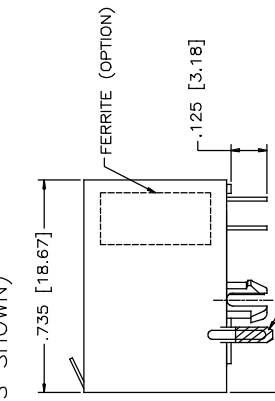

NON-SHIELDED
(8 POSITION, 8 CONTACTS SHOWN)

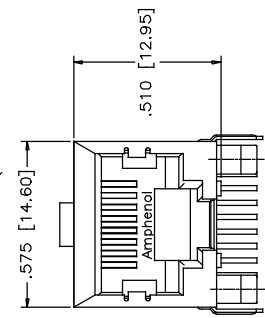
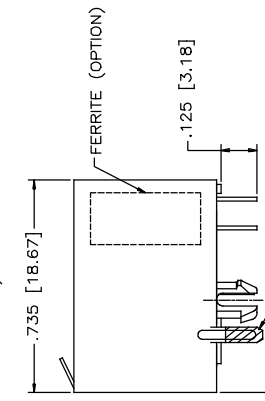

SHIELDED
(8 POSITION, 8 CONTACTS SHOWN)

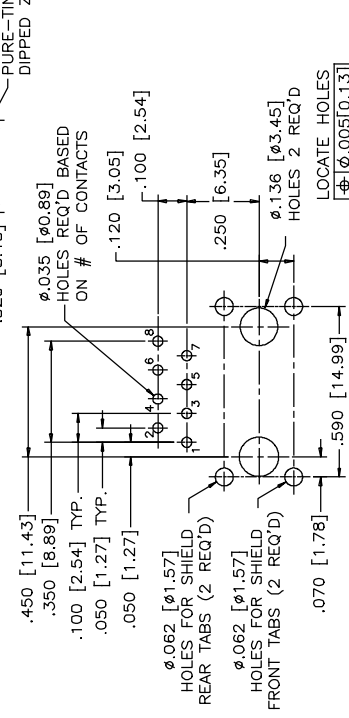

RECOMMENDED P.C.B. LAYOUT

MATERIALS:
PLASTIC HOUSING: HIGH TEMPERATURE THERMOPLASTIC
FLAMMABILITY RATING UL 94V-0

CONTACTS:
PHOSPHOR BRONZE
PLATING: 50 μ " [1.27 MICRONS]
MIN. GOLD ON MATING SURFACES.
50 μ " [1.27 MICRONS]
MIN. NICKEL UNDERPLATE
GOLD FLASH ON CONTACT TAILS.

SHIELD:
COPPER ALLOY
PLATING: NICKEL WITH PURE-TIN DIPPED PCB TAIL.

ELECTRICAL CHARACTERISTICS:
VOLTAGE RATING: 125 VOLTS AC.
CURRENT RATING: 1.5 AMPS.

RJ CONNECTOR CONFORMS TIA-1096-A.

REV	
A	
B	
C	
D	

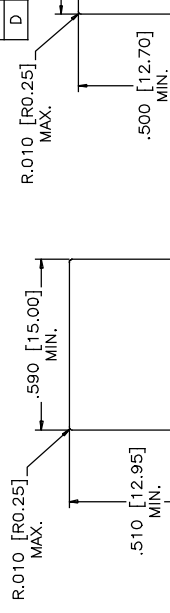

RECOMMENDED PANEL CUTOUT
SHIELDED

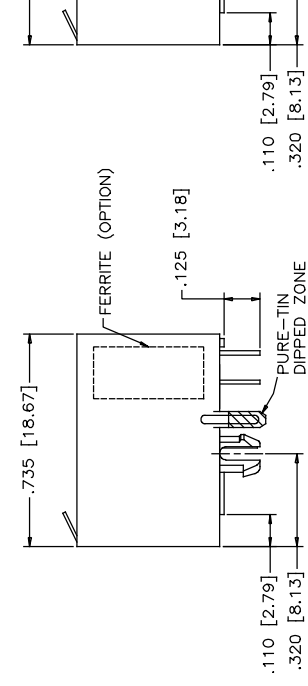

SHIELDED
(8 POSITION, 8 CONTACTS SHOWN)

FR/JAE CONNECTOR NUMBER SYSTEM

EXAMPLE: F R J A E - X X X

SERIES _____

CONNECTOR STYLE & POSITIONS

- 4=RJ45 OR 8 POSITIONS
- 6=RJ11 OR 6 POSITIONS

OPTIONS

- 0=NON FILTERED, NON SHIELDED
- 1=FILTERED WITH FRONT TAIL SHIELD
- 3=SHIELD (FRONT TAIL)
- 4=FILTERED
- 6=FILTERED WITH REAR TAIL SHIELD
- 7=FILTERED WITH NON-TAIL SHIELD
- 8=SHIELD (REAR TAIL)
- 9=SHIELD (NON-TAIL)

8	-	8	PC
6	-	6	PC
4	-	4	PC
2	-	2	PC
C	-	C	2



UNLESS SPECIFIED OTHERWISE	DRAWN	PAULW	DEC25/05
PRIMARY UNITS	INCHES	CHECKED	CHIGOW
SECONDARY	MILLIMETERS	M.E. APP'D	
REFERENCE IN PARENTHESES	Q.A. APP'D		
GENERAL TOLERANCES	DWG APP'D		
1 DECIMAL PLACE	±0.025	ENG. REL. NO.	
2 DECIMAL PLACES	±0.020	REF.	
3 DECIMAL PLACES	±0.015		
ANGULAR DEGREES	±1°		

DO NOT SCALE DRAWING	
THIRD ANGLE PROJECTION	

THIS DOCUMENT CONTAINS PROPRIETARY INFORMATION AND SUCH INFORMATION MAY NOT BE DISCLOSED TO OTHERS FOR ANY PURPOSE OR USED FOR MANUFACTURING PURPOSES WITHOUT WRITTEN PERMISSION FROM AMPHENOL CANADA CORP.

Looking for pricing, stock, or lifecycle information?

Click below to explore more details on WIN SOURCE:

-  [View FRJAE616 on WIN SOURCE](#)
-  [Amphenol Commercial Products Information](#)

Optimize Your Supply Chain with WIN SOURCE Solutions

-  Global Sourcing Solution
-  Obsolete Management
-  Cost Control Management
-  Shortage Management
-  Alternative Solution
-  Excess Inventory Management