

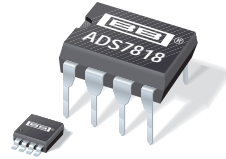

**THE DATASHEET OF  
ADS7818E/250G4**





# ADS7818

For most current data sheet and other product information, visit [www.burr-brown.com](http://www.burr-brown.com)

## 12-Bit High Speed Low Power Sampling ANALOG-TO-DIGITAL CONVERTER

### FEATURES

- 500kHz THROUGHPUT RATE
- 2.5V INTERNAL REFERENCE
- LOW POWER: 11mW
- SINGLE SUPPLY +5V OPERATION
- DIFFERENTIAL INPUT
- SERIAL INTERFACE
- GUARANTEED NO MISSING CODES
- MINI-DIP-8 AND MSOP-8
- UNIPOLAR INPUT RANGE

### APPLICATIONS

- BATTERY OPERATED SYSTEMS
- DIGITAL SIGNAL PROCESSING
- HIGH SPEED DATA ACQUISITION
- WIRELESS COMMUNICATION SYSTEMS

### DESCRIPTION

The ADS7818 is a 12-bit sampling analog-to-digital converter (A/D) complete with sample/hold, internal 2.5V reference, and synchronous serial interface. Typical power dissipation is 11mW at a 500kHz throughput rate. The device can be placed into a power down mode which reduces dissipation to just 2.5mW. The input range is zero to two times the reference voltage, and the internal reference can be overdriven by an external voltage.

Low power, small size, and high-speed make the ADS7818 ideal for battery operated systems such as wireless communication devices, portable multi-channel data loggers, and spectrum analyzers. The serial interface also provides low-cost isolation for remote data acquisition. The ADS7818 is available in a plastic mini-DIP-8 or an MSOP-8 package and is guaranteed over the  $-40^{\circ}\text{C}$  to  $+85^{\circ}\text{C}$  temperature range.

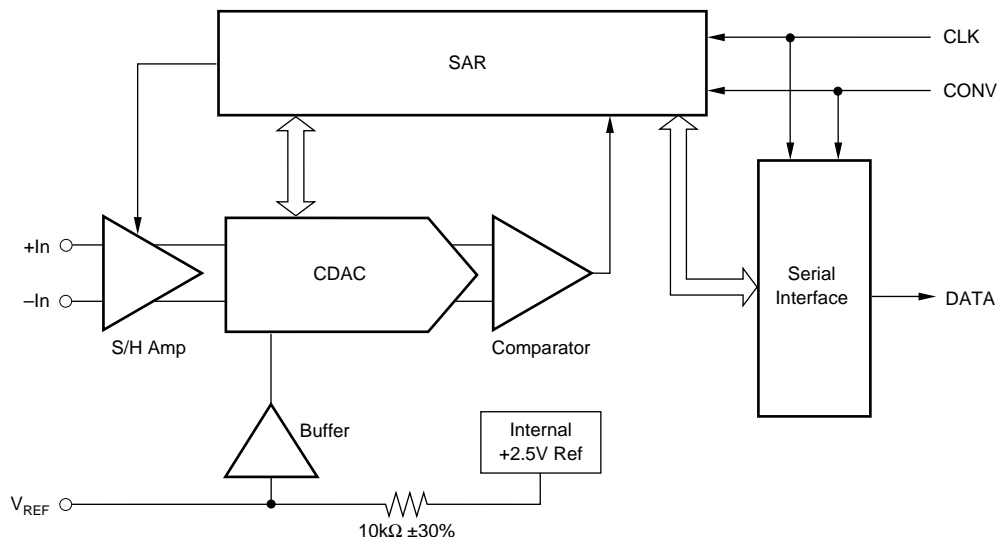

International Airport Industrial Park • Mailing Address: PO Box 11400, Tucson, AZ 85734 • Street Address: 6730 S. Tucson Blvd., Tucson, AZ 85706 • Tel: (520) 746-1111  
Twx: 910-952-1111 • Internet: <http://www.burr-brown.com/> • Cable: BBRCORP • Telex: 066-6491 • FAX: (520) 889-1510 • Immediate Product Info: (800) 548-6132

# SPECIFICATIONS

At  $T_A = -40^\circ\text{C}$  to  $+85^\circ\text{C}$ ,  $+V_{CC} = +5\text{V}$ ,  $f_{\text{SAMPLE}} = 500\text{kHz}$ ,  $f_{\text{CLK}} = 16 \cdot f_{\text{SAMPLE}}$ , internal reference, unless otherwise specified.

| PARAMETER                                | CONDITIONS  | ADS7818P, E |                 |                | ADS7818PB, EB |           |          | UNITS              |
|--|---|-------------|-----------------|----------------|---------------|-----------|----------|--------------------|
|  |   | MIN         | TYP             | MAX            | MIN           | TYP       | MAX      |                    |
| <b>ANALOG INPUT</b>                      |   |             |                 |                |               |           |          |                    |
| Full-Scale Input Span <sup>(1)</sup>     | +In – (–In)   | 0           |                 | 5              | *             |           | *        | V                  |
| Absolute Input Range                     | +In   | –0.2        |                 | $V_{CC} + 0.2$ | *             |           | *        | V                  |
|  | –In   | –0.2        |                 | +0.2           | *             |           | *        | V                  |
| Capacitance                              |   |             | 15              |                |               | *         |          | pF                 |
| Leakage Current                          |   |             | 1               |                |               | *         |          | $\mu\text{A}$      |
| <b>SYSTEM PERFORMANCE</b>                |   |             |                 |                |               |           |          |                    |
| Resolution                               |   | 12          | 12              |                | *             | *         |          | Bits               |
| No Missing Codes                         |   |             |                 |                | *             |           |          | Bits               |
| Integral Linearity Error                 |   |             | $\pm 1$         | $\pm 2$        |               | $\pm 0.5$ | $\pm 1$  | LSB <sup>(2)</sup> |
| Differential Linearity Error             |   |             | $\pm 0.8$       |                |               | $\pm 0.5$ | $\pm 1$  | LSB                |
| Offset Error                             |   |             | $\pm 2$         | $\pm 5$        |               | $\pm 1$   | *        | LSB                |
| Gain Error <sup>(3)</sup>                | 25°C  |             | $\pm 12$        | $\pm 30$       |               | $\pm 7$   | $\pm 15$ | LSB                |
|  | –40°C to +85°C                                      |             |                 | $\pm 50$       |               |           | $\pm 35$ | LSB                |
| Common-Mode Rejection                    | DC, 0.2Vp-p   |             | 70              |                |               | *         |          | dB                 |
|  | 1MHz, 0.2Vp-p                                       |             | 50              |                |               | *         |          | dB                 |
| Noise                                    |   |             | 150             |                |               | *         |          | $\mu\text{Vrms}$   |
| Power Supply Rejection                   | Worst Case $\Delta$ , $+V_{CC} = 5\text{V} \pm 5\%$ |             | 1.2             |                |               | *         |          | LSB                |
| <b>SAMPLING DYNAMICS</b>                 |   |             |                 |                |               |           |          |                    |
| Conversion Time                          |   | 1.625       |                 |                | *             |           |          | $\mu\text{s}$      |
| Acquisition Time                         |   | 0.350       |                 |                | *             |           |          | $\mu\text{s}$      |
| Throughput Rate                          |   |             |                 | 500            |               |           | *        | kHz                |
| Aperture Delay                           |   |             | 5               |                |               | *         |          | ns                 |
| Aperture Jitter                          |   |             | 30              |                |               | *         |          | ps                 |
| Step Response                            |   |             | 350             |                |               | *         |          | ns                 |
| <b>DYNAMIC CHARACTERISTICS</b>           |   |             |                 |                |               |           |          |                    |
| Signal-to-Noise Ratio                    | $V_{\text{IN}} = 5\text{Vp-p}$ at 100kHz            |             | 72              |                |               | *         |          | dB                 |
| Total Harmonic Distortion <sup>(4)</sup> | $V_{\text{IN}} = 5\text{Vp-p}$ at 100kHz            |             | –78             | –72            |               | –82       | –75      | dB                 |
| Signal-to-(Noise+Distortion)             | $V_{\text{IN}} = 5\text{Vp-p}$ at 100kHz            | 68          | 70              |                | 70            | 72        |          | dB                 |
| Spurious Free Dynamic Range              | $V_{\text{IN}} = 5\text{Vp-p}$ at 100kHz            | 72          | 78              |                | 75            | 82        |          | dB                 |
| Usable Bandwidth                         | SINAD > 68dB  |             | 350             |                |               | *         |          | kHz                |
| <b>REFERENCE OUTPUT</b>                  |   |             |                 |                |               |           |          |                    |
| Voltage                                  | $I_{\text{OUT}} = 0$                                | 2.475       | 2.50            | 2.525          | 2.48          | *         | 2.52     | V                  |
| Source Current <sup>(5)</sup>            | Static Load   |             |                 | 50             |               | *         | *        | $\mu\text{A}$      |
| Drift                                    | $I_{\text{OUT}} = 0$                                |             | 20              |                |               | *         |          | ppm/°C             |
| Line Regulation                          | $4.75\text{V} \leq V_{CC} \leq 5.25\text{V}$        |             | 0.6             |                |               | *         |          | mV                 |
| <b>REFERENCE INPUT</b>                   |   |             |                 |                |               |           |          |                    |
| Range                                    |   | 2.0         |                 | 2.55           | *             |           | *        | V                  |
| Resistance <sup>(6)</sup>                | to Internal Reference Voltage                       |             | 10              |                | *             | *         | *        | k $\Omega$         |
| <b>DIGITAL INPUT/OUTPUT</b>              |   |             |                 |                |               |           |          |                    |
| Logic Family                             |   |             | CMOS            |                |               | *         |          |                    |
| Logic Levels:                            |   |             |                 |                |               |           |          |                    |
| $V_{\text{IH}}$                          | $ I_{\text{IH}}  \leq +5\mu\text{A}$                | 3.0         |                 | $V_{CC} + 0.3$ | *             |           | *        | V                  |
| $V_{\text{IL}}$                          | $ I_{\text{IL}}  \leq +5\mu\text{A}$                | –0.3        |                 | 0.8            | *             |           | *        | V                  |
| $V_{\text{OH}}$                          | $I_{\text{OH}} = -500\mu\text{A}$                   | 3.5         |                 |                | *             |           | *        | V                  |
| $V_{\text{OL}}$                          | $I_{\text{OL}} = 500\mu\text{A}$                    |             |                 | 0.4            | *             |           | *        | V                  |
| Data Format                              |   |             | Straight Binary |                |               | *         |          |                    |
| <b>POWER SUPPLY REQUIREMENT</b>          |   |             |                 |                |               |           |          |                    |
| + $V_{CC}$                               | Specified Performance                               | 4.75        |                 | 5.25           | *             |           | *        | V                  |
| Quiescent Current                        | $f_{\text{SAMPLE}} = 500\text{kHz}$<br>Power Down   |             | 2.2<br>0.5      |                |               | *         | *        | mA<br>mA           |
| Power Dissipation                        | $f_{\text{SAMPLE}} = 500\text{kHz}$<br>Power Down   |             | 11<br>2.5       | 20             |               | *         | *        | mW<br>mW           |
| <b>TEMPERATURE RANGE</b>                 |   |             |                 |                |               |           |          |                    |
| Specified Performance                    |   | –40         |                 | +85            | *             |           | *        | °C                 |

\* Specifications same as ADS7818P,E.

NOTES: (1) Ideal input span, does not include gain or offset error. (2) LSB means Least Significant Bit, with  $V_{\text{REF}}$  equal to +2.5V, one LSB is 1.22mV. (3) Measured relative to an ideal, full-scale input (+In – (–In)) of 4.999V. Thus, gain error includes the error of the internal voltage reference. (4) Calculated on the first nine harmonics of the input frequency. (5) If the internal reference is required to source current to an external load, the reference voltage will change due to the internal 10k $\Omega$  resistor. (6) Can vary  $\pm 30\%$ .

The information provided herein is believed to be reliable; however, BURR-BROWN assumes no responsibility for inaccuracies or omissions. BURR-BROWN assumes no responsibility for the use of this information, and all use of such information shall be entirely at the user's own risk. Prices and specifications are subject to change without notice. No patent rights or licenses to any of the circuits described herein are implied or granted to any third party. BURR-BROWN does not authorize or warrant any BURR-BROWN product for use in life support devices and/or systems.

## ABSOLUTE MAXIMUM RATINGS<sup>(1)</sup>

|   |                                   |
|---|-----------------------------------|
| +V <sub>CC</sub> to GND .....           | -0.3V to 6V                       |
| Analog Inputs to GND .....              | -0.3V to (V <sub>CC</sub> + 0.3V) |
| Digital Inputs to GND .....             | -0.3V to (V <sub>CC</sub> + 0.3V) |
| Power Dissipation .....                 | 325mW                             |
| Maximum Junction Temperature .....      | +150°C                            |
| Operating Temperature Range .....       | -40°C to +85°C                    |
| Storage Temperature Range .....         | -65°C to +150°C                   |
| Lead Temperature (soldering, 10s) ..... | +300°C                            |

NOTE: (1) Stresses above those listed under "Absolute Maximum Ratings" may cause permanent damage to the device. Exposure to absolute maximum conditions for extended periods may affect device reliability.



## ELECTROSTATIC DISCHARGE SENSITIVITY

Electrostatic discharge can cause damage ranging from performance degradation to complete device failure. Burr-Brown Corporation recommends that all integrated circuits be handled and stored using appropriate ESD protection methods.

ESD damage can range from subtle performance degradation to complete device failure. Precision integrated circuits may be more susceptible to damage because very small parametric changes could cause the device not to meet published specifications.

## PIN CONFIGURATION

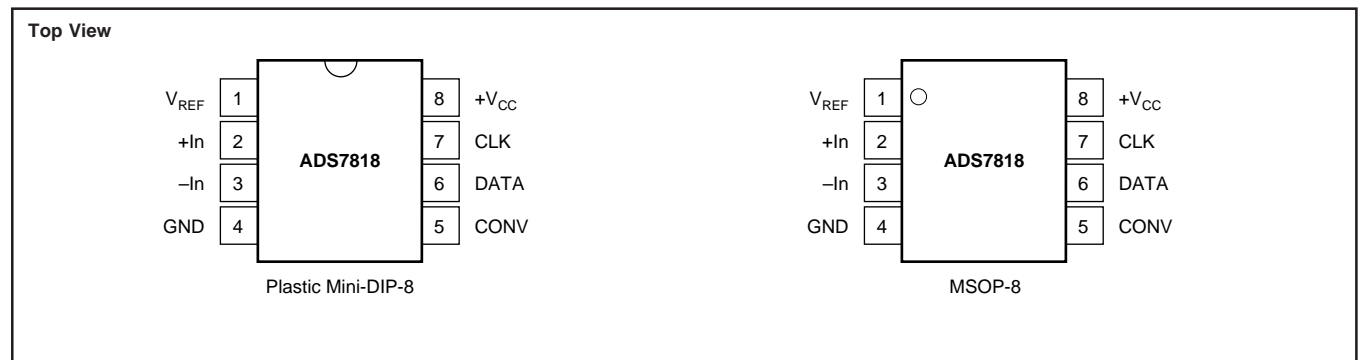

## PIN ASSIGNMENTS

| PIN | NAME             | DESCRIPTION   |
|-----|------------------|---|
| 1   | V <sub>REF</sub> | Reference Output. Decouple to ground with a 0.1μF ceramic capacitor and a 2.2μF tantalum capacitor.   |
| 2   | +In              | Non-Inverting Input.  |
| 3   | -In              | Inverting Input. Connect to ground or to remote ground sense point.   |
| 4   | GND              | Ground.   |
| 5   | CONV             | Convert Input. Controls the sample/hold mode, start of conversion, start of serial data transfer, type of serial transfer, and power down mode. See the Digital Interface section for more information.   |
| 6   | DATA             | Serial Data Output. The 12-bit conversion result is serially transmitted most significant bit first with each bit valid on the rising edge of CLK. By properly controlling the CONV input, it is possible to have the data transmitted least significant bit first. See the Digital Interface section for more information. |
| 7   | CLK              | Clock Input. Synchronizes the serial data transfer and determines conversion speed.   |
| 8   | +V <sub>CC</sub> | Power Supply. Decouple to ground with a 0.1μF ceramic capacitor and a 10μF tantalum capacitor.  |

## PACKAGE/ORDERING INFORMATION

| PRODUCT   | MAXIMUM INTEGRAL LINEARITY ERROR (LSB) | MAXIMUM DIFFERENTIAL LINEARITY ERROR (LSB) | PACKAGE       | PACKAGE DRAWING NUMBER <sup>(1)</sup> | SPECIFICATION TEMPERATURE RANGE | PACKAGE MARKING <sup>(2)</sup> | ORDERING NUMBER <sup>(3)</sup> | TRANSPORT MEDIA |
|-----------|--|--|---------------|---------------------------------------|---------------------------------|--------------------------------|--------------------------------|-----------------|
| ADS7818E  | ±2                                     | N/S <sup>(4)</sup>                         | MSOP-8        | 337                                   | -40°C to +85°C                  | A18                            | ADS7818E/250                   | Tape and Reel   |
| ADS7818EB | ±1                                     | ±1   | MSOP-8        | 337                                   | -40°C to +85°C                  | A18                            | ADS7818EB/250                  | Tape and Reel   |
| ADS7818P  | ±2                                     | N/S <sup>(4)</sup>                         | Plastic DIP-8 | 006                                   | -40°C to +85°C                  | ADS7818P                       | ADS7818P                       | Rails           |
| ADS7818PB | ±1                                     | ±1   | "             | "                                     | "                               | ADS7818PB                      | ADS7818PB                      | Rails           |

NOTE: (1) For detail drawing and dimension table, please see end of data sheet or Package Drawing File on Web. (2) Performance Grade information is marked on the reel. (3) Models with a slash(/) are available only in Tape and reel in quantities indicated (e.g. /250 indicates 250 units per reel, /2K5 indicates 2500 devices per reel). Ordering 2500 pieces of "ADS7818E/2K5" will get a single 2500-piece Tape and Reel. For detailed Tape and Reel mechanical information, refer to the www.burr-brown.com web site under Applications and Tape and Reel Orientation and Dimensions. (4) N/S = Not Specified, typical only. However, 12-Bits no missing codes is guaranteed over temperature.

# TYPICAL PERFORMANCE CURVES

At  $T_A = +25^\circ\text{C}$ ,  $V_{CC} = +5\text{V}$ ,  $f_{\text{SAMPLE}} = 500\text{kHz}$ ,  $f_{\text{CLK}} = 16 \cdot f_{\text{SAMPLE}}$ , and internal +2.5V reference, unless otherwise specified.

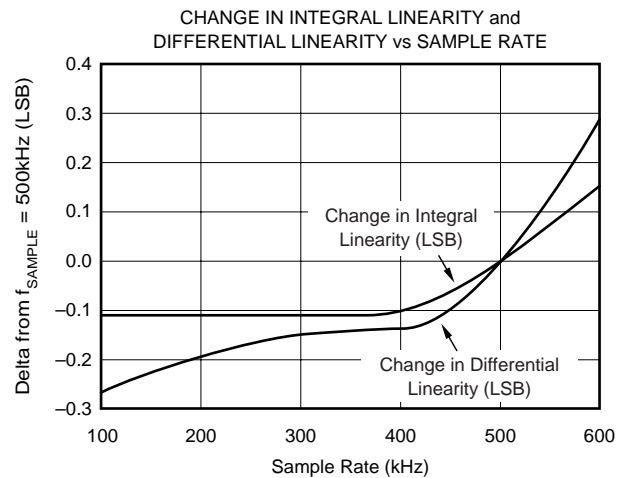
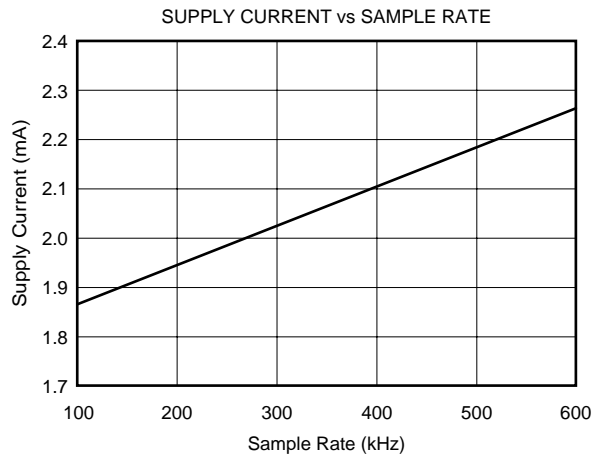
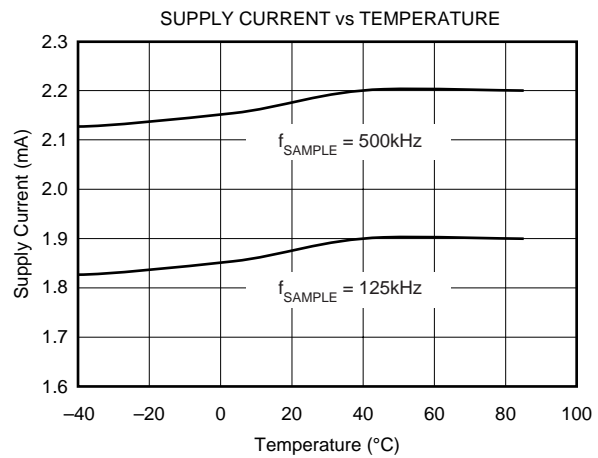
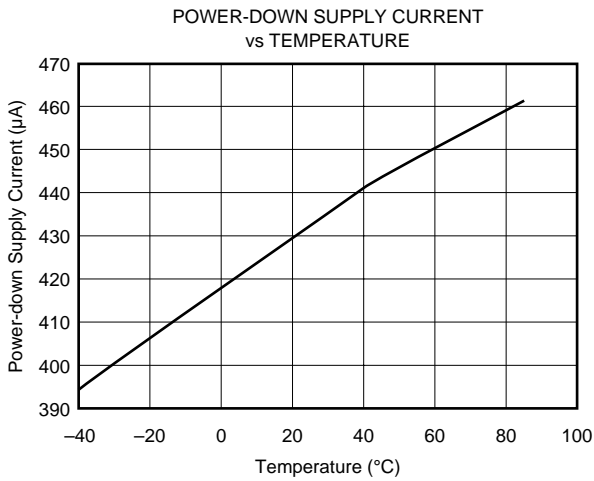
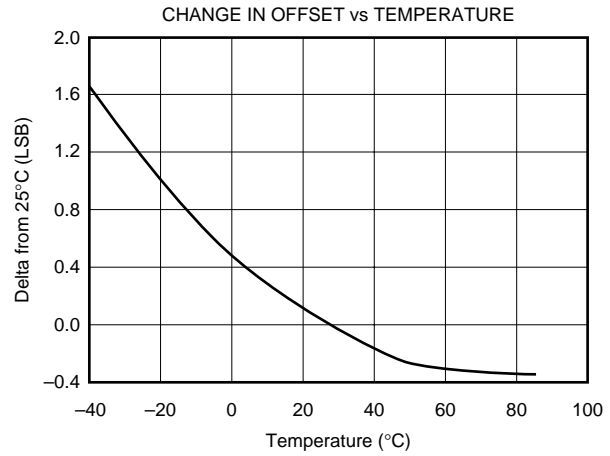
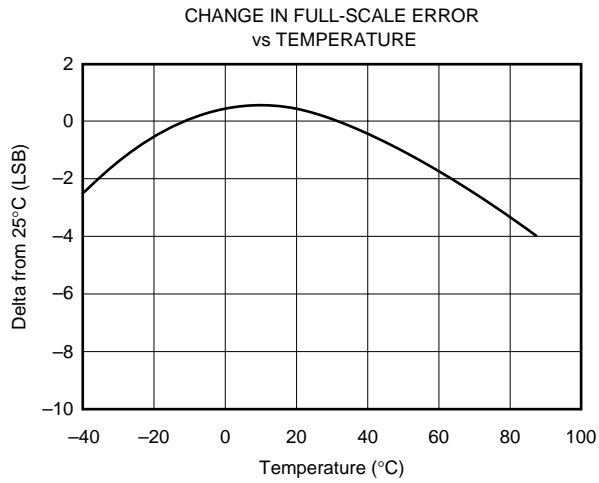

# TYPICAL PERFORMANCE CURVES (Cont.)

At  $T_A = +25^\circ\text{C}$ ,  $V_{CC} = +5\text{V}$ ,  $f_{\text{SAMPLE}} = 500\text{kHz}$ ,  $f_{\text{CLK}} = 16 \cdot f_{\text{SAMPLE}}$ , and internal +2.5V reference, unless otherwise specified.

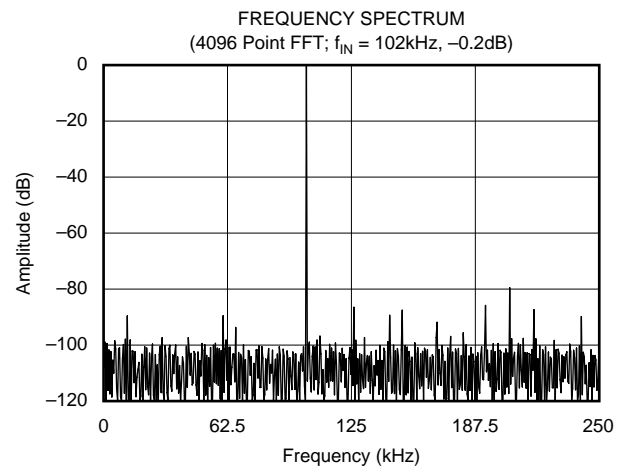
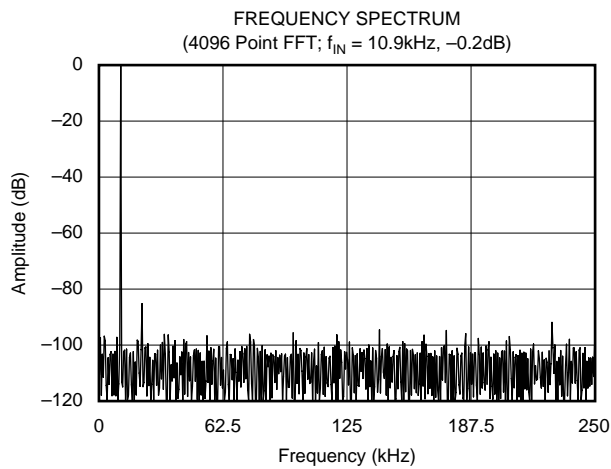
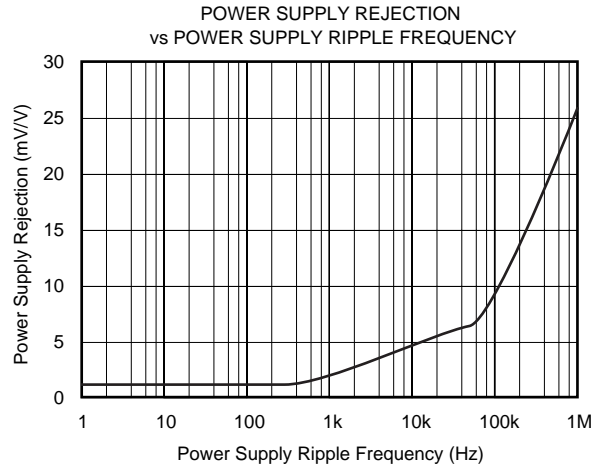
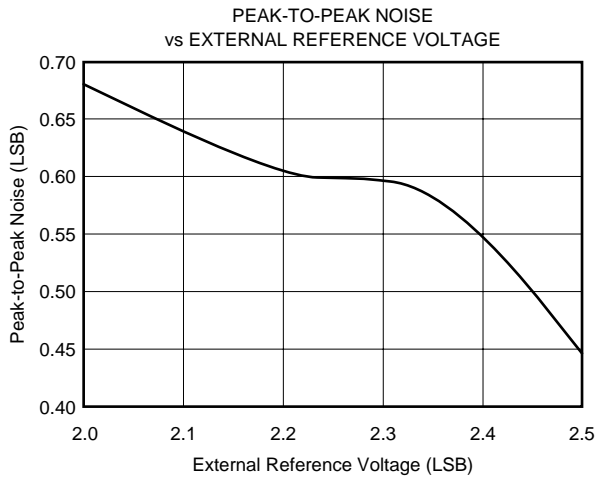
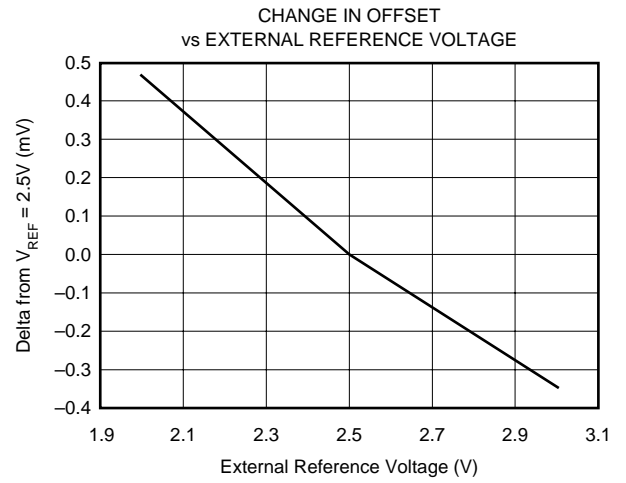
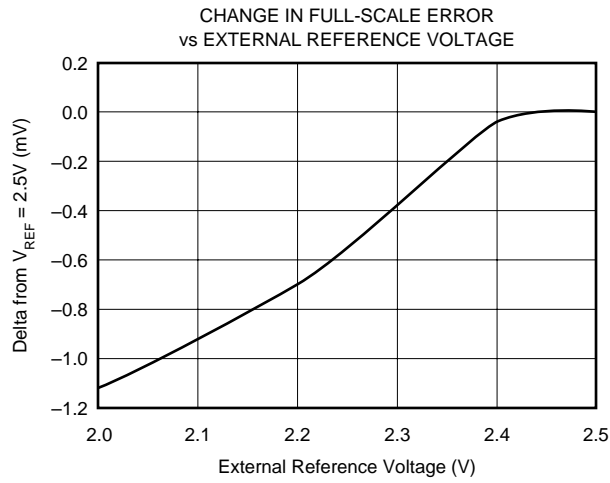

# TYPICAL PERFORMANCE CURVES (Cont.)

At  $T_A = +25^\circ\text{C}$ ,  $V_{CC} = +5\text{V}$ ,  $f_{\text{SAMPLE}} = 500\text{kHz}$ ,  $f_{\text{CLK}} = 16 \cdot f_{\text{SAMPLE}}$ , and internal +2.5V reference, unless otherwise specified.

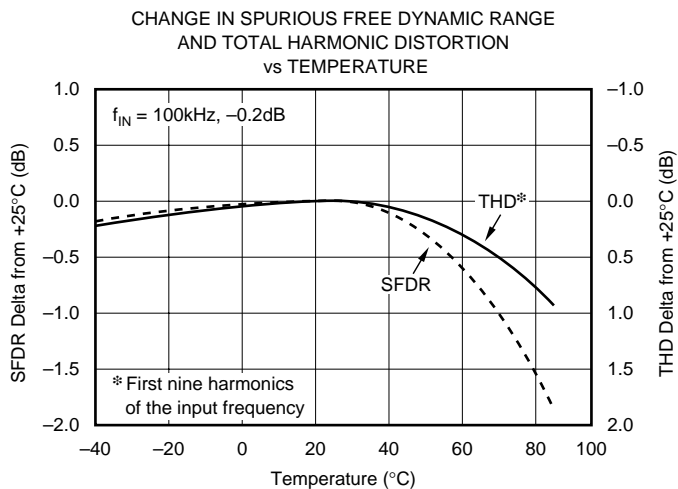
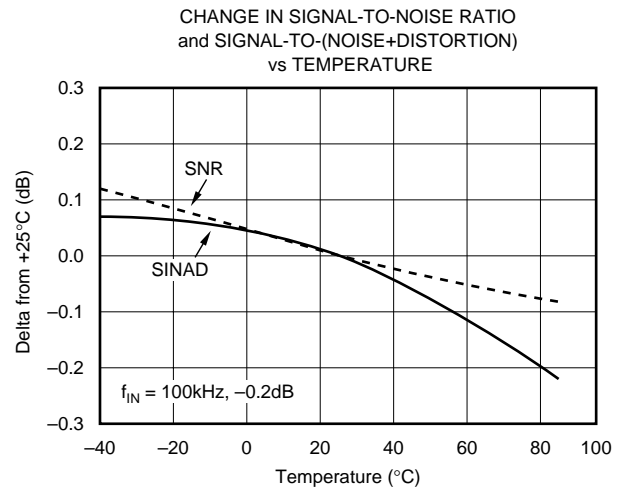
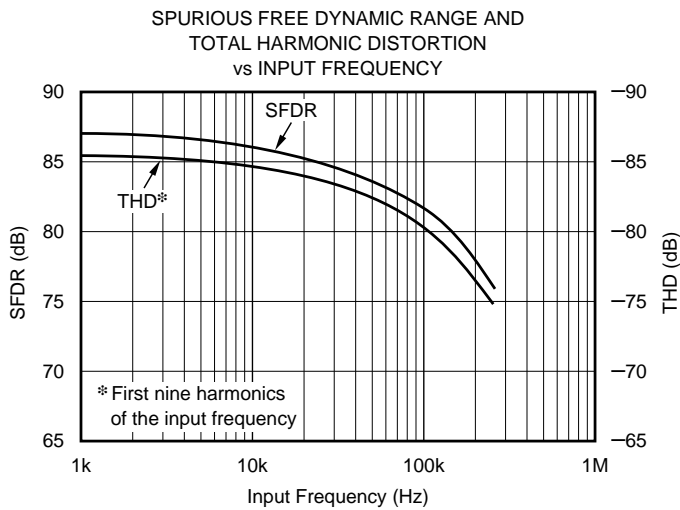
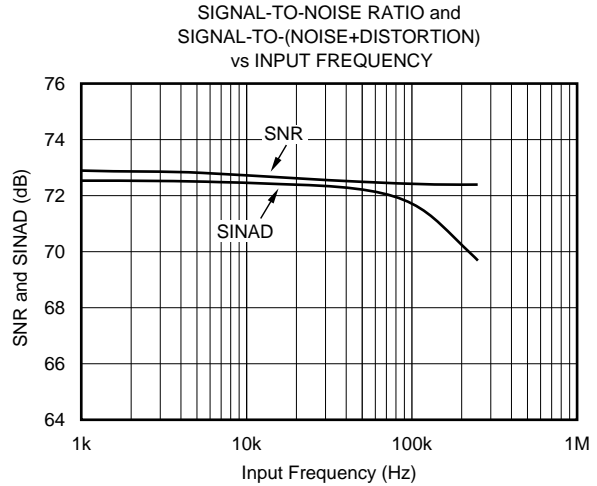
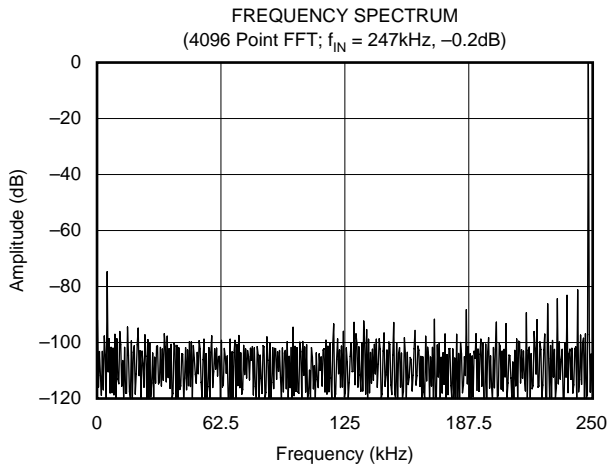

# THEORY OF OPERATION

The ADS7818 is a high speed successive approximation register (SAR) analog-to-digital converter (A/D) with an internal 2.5V bandgap reference. The architecture is based on capacitive redistribution which inherently includes a sample/hold function. The converter is fabricated on a 0.6 $\mu$ m CMOS process. See Figure 1 for the basic operating circuit for the ADS7818.

The ADS7818 requires an external clock to run the conversion process. This clock can vary between 200kHz (12.5MHz throughput) and 8MHz (500kHz throughput). The duty cycle of the clock is unimportant as long as the minimum HIGH and LOW times are at least 50ns and the clock period is at least 125ns. The minimum clock frequency is set by the leakage on the capacitors internal to the ADS7818.

The analog input is provided to two input pins: +IN and -IN. When a conversion is initiated, the differential input on these pins is sampled on the internal capacitor array. While a conversion is in progress, both inputs are disconnected from any internal function.

The range of the analog input is set by the voltage on the V<sub>REF</sub> pin. With the internal 2.5V reference, the input range is 0 to 5V. An external reference voltage can be placed on V<sub>REF</sub>, overdriving the internal voltage. The range for the external voltage is 2.0V to 2.55V, giving an input voltage range of 4.0V to 5.1V.

The digital result of the conversion is provided in a serial manner, synchronous to the CLK input. The result is provided most significant bit first and represents the result of the conversion currently in progress—there is no pipeline delay. By properly controlling the CONV and CLK inputs, it is possible to obtain the digital result least significant bit first.

## ANALOG INPUT

The +IN and -IN input pins allow for a differential input signal to be captured on the internal hold capacitor when the converter enters the hold mode. The voltage range on the -IN input is limited to -0.2V to 0.2V. Because of this, the differential input can be used to reject only small signals that

are common to both inputs. Thus, the -IN input is best used to sense a remote ground point near the source of the +IN signal. If the source driving the +IN signal is nearby, the -IN should be connected directly to ground.

The input current into the analog input depends on input voltage and sample rate. Essentially, the current into the device must charge the internal hold capacitor during the sample period. After this capacitance has been fully charged, there is no further input current. The source of the analog input voltage must be able to charge the input capacitance to a 12-bit settling level within the sample period—which can be as little as 350ns in some operating modes. While the converter is in the hold mode or after the sampling capacitor has been fully charged, the input impedance of the analog input is greater than 1G $\Omega$ .

Care must be taken regarding the input voltage on the +IN and -IN pins. To maintain the linearity of the converter, the +IN input should remain within the range of GND - 200mV to +V<sub>CC</sub> + 200mV. The -IN input should not drop below GND - 200mV or exceed GND + 200mV. Outside of these ranges, the converter's linearity may not meet specifications.

## REFERENCE

The reference voltage on the V<sub>REF</sub> pin directly sets the full-scale range of the analog input. The ADS7818 can operate with a reference in the range of 2.0V to 2.55V, for a full-scale range of 4.0V to 5.1V.

The voltage at the V<sub>REF</sub> pin is internally buffered and this buffer drives the capacitor DAC portion of the converter. This is important because the buffer greatly reduces the dynamic load placed on the reference source. However, the voltage at V<sub>REF</sub> will still contain some noise and glitches from the SAR conversion process. These can be reduced by carefully bypassing the V<sub>REF</sub> pin to ground as outlined in the sections that follow.

## INTERNAL REFERENCE

The ADS7818 contains an on-board 2.5V reference, resulting in a 0V to 5V input range on the analog input. The specification table gives the various specifications for the

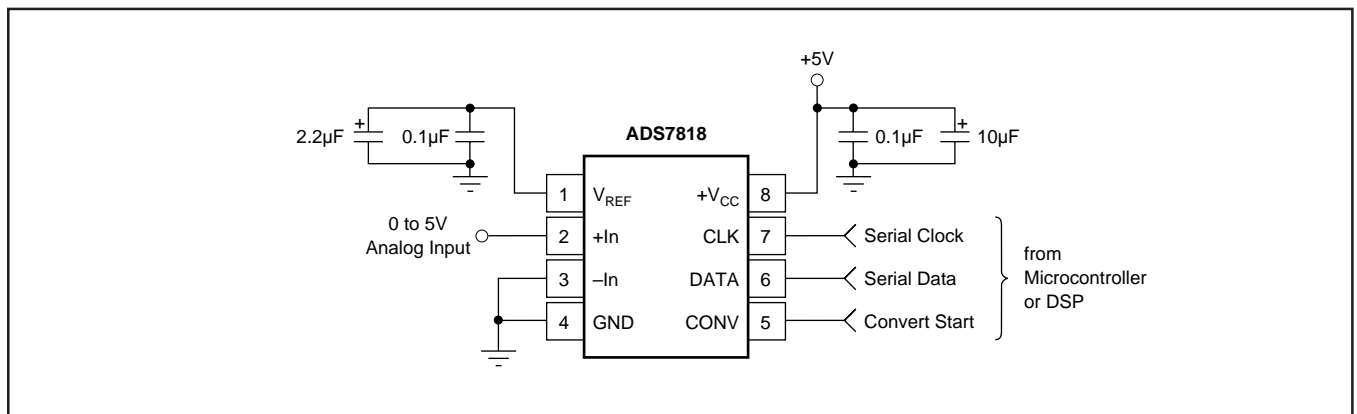

FIGURE 1. Basic Operation of the ADS7818.

internal reference. This reference can be used to supply a small amount of source current to an external load, but the load should be static. Due to the internal 10kΩ resistor, a dynamic load will cause variations in the reference voltage, and will dramatically affect the conversion result. Note that even a static load will reduce the internal reference voltage seen at the buffer input. The amount of reduction depends on the load and the actual value of the internal “10kΩ” resistor. The value of this resistor can vary by ±30%.

The  $V_{REF}$  pin should be bypassed with a 0.1μF capacitor placed as close as possible to the ADS7818 package. In addition, a 2.2 μF tantalum capacitor should be used in parallel with the ceramic capacitor. Placement of this capacitor is not as critical.

## EXTERNAL REFERENCE

The internal reference is connected to the  $V_{REF}$  pin and to the internal buffer via a 10kΩ series resistor. Thus, the reference voltage can easily be overdriven by an external reference voltage. The voltage range for the external voltage is 2.0V to 2.55V, corresponding to an analog input range of 4.0V to 5.1V.

While the external reference will not source significant current into the  $V_{REF}$  pin, it does have to drive the series 10kΩ resistor that is terminated into the 2.5V internal reference (the exact value of the resistor will vary up to ±30% from part to part). In addition, the  $V_{REF}$  pin should still be bypassed to ground with at least a 0.1 μF ceramic capacitor (placed as close to the ADS7818 as possible). The reference will have to be stable with this capacitive load. Depending on the particular reference and A/D conversion speed, additional bypass capacitance may be required, such as the 2.2μF tantalum capacitor shown in Figure 1.

Reasons for choosing an external reference over the internal reference vary, but there are two main reasons. One is to achieve a given input range. For example, a 2.048V reference provides for a 0V to 4.095V input range—or 1mV per LSB. The other is to provide greater stability over temperature. The internal reference is typically 20ppm/°C which translates into a full-scale drift of roughly 1 output code for every 12°C (this does not take into account other sources of full-scale drift). If greater stability over temperature is needed, then an external reference with lower temperature drift will be required.

## DIGITAL INTERFACE

Figure 2 shows the serial data timing and Figure 3 shows the basic conversion timing for the ADS7818. The specific timing numbers are listed in Table I. There are several important items in Figure 3 which give the converter additional capabilities over typical 8-pin converters. First, the transition from sample mode to hold mode is synchronous to the falling edge of CONV and is not dependent on CLK. Second, the CLK input is not required to be continuous during the sample mode. After the conversion is complete, the CLK may be kept LOW or HIGH.

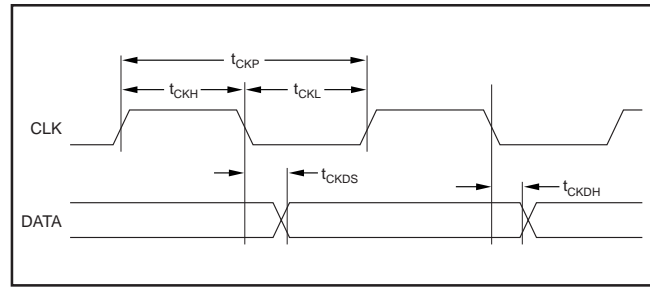

FIGURE 2. Serial Data and Clock Timing.

| SYMBOL     | DESCRIPTION   | MIN | TYP | MAX  | UNITS |
|------------|---|-----|-----|------|-------|
| $t_{ACQ}$  | Acquisition Time  | 350 |     |      | ns    |
| $t_{CONV}$ | Conversion Time   | 1.5 |     |      | μs    |
| $t_{CKP}$  | Clock Period  | 125 |     | 5000 | ns    |
| $t_{CKL}$  | Clock LOW   | 50  |     |      | ns    |
| $t_{CKH}$  | Clock HIGH  | 50  |     |      | ns    |
| $t_{CKDH}$ | Clock Falling to Current Data Bit No Longer Valid       | 5   | 15  |      | ns    |
| $t_{CKDS}$ | Clock Falling to Next Data Valid                        |     | 30  | 50   | ns    |
| $t_{CVL}$  | CONV LOW  | 40  |     |      | ns    |
| $t_{CVH}$  | CONV HIGH   | 40  |     |      | ns    |
| $t_{CKCH}$ | CONV Hold after Clock Falls <sup>(1)</sup>              | 10  |     |      | ns    |
| $t_{CKCS}$ | CONV Setup to Clock Falling <sup>(1)</sup>              | 10  |     |      | ns    |
| $t_{CKDE}$ | Clock Falling to DATA Enabled                           |     | 20  | 50   | ns    |
| $t_{CKDD}$ | Clock Falling to DATA High Impedance                    |     | 70  | 100  | ns    |
| $t_{CKSP}$ | Clock Falling to Sample Mode                            |     | 5   |      | ns    |
| $t_{CKPD}$ | Clock Falling to Power-down Mode                        |     | 50  |      | ns    |
| $t_{CVHD}$ | CONV Falling to Hold Mode (Aperture Delay)              |     | 5   |      | ns    |
| $t_{CVSP}$ | CONV Rising to Sample Mode                              |     | 5   |      | ns    |
| $t_{CVPU}$ | CONV Rising to Full Power-up                            |     | 50  |      | ns    |
| $t_{CVDD}$ | CONV Changing State to DATA High Impedance              |     | 70  | 100  | ns    |
| $t_{CVPD}$ | CONV Changing State to Power-down Mode                  |     | 50  |      | ns    |
| $t_{DRP}$  | CONV Falling to Start of CLK (for hold droop < 0.1 LSB) |     |     | 5    | μs    |

Note: (1) This timing is not required under some situations. See text for more information.

TABLE I. Timing Specifications ( $T_A = -40^{\circ}\text{C}$  to  $+85^{\circ}\text{C}$ ,  $C_{LOAD} = 30\text{pF}$ ).

The asynchronous nature of CONV to CLK raises some interesting possibilities, but also some design considerations. Figure 3 shows that CONV has timing restraints in relation to CLK ( $t_{CKCH}$  and  $t_{CKCS}$ ). However, if these times are violated (which could happen if CONV is completely asynchronous to CLK), the converter will perform a conversion correctly, but the exact timing of the conversion is indeterminate. Since the setup and hold time between CONV and CLK has been violated in this example, the start of conversion could vary by one clock cycle. (Note that the start of conversion can be detected by using a pull-up resistor on DATA. When DATA drops out of high-impedance and goes LOW, the conversion has started and that clock cycle is this first of the conversion.)

In addition if CONV is completely asynchronous to CLK and CLK is continuous, then there is possibility that CLK will transition just prior to CONV going LOW. If this occurs

faster than the 10ns indicated by  $t_{CKCH}$ , then there is a chance that some digital feedthrough may be coupled onto the hold capacitor. This could cause a small offset error for that particular conversion.

Thus, there are two basic ways to operate the ADS7818. CONV can be synchronous to CLK and CLK can be continuous. This would be the typical situation when interfacing the converter to a digital signal processor. The second method involves having CONV asynchronous to CLK and gating the operation of CLK (a non-continuous clock). This method would be more typical of an SPI-like interface on a microcontroller. This method would also allow CONV to be generated by a trigger circuit and to initiate (after some delay) the start of CLK. These two methods are covered under DSP Interfacing and SPI Interfacing.

### POWER-DOWN TIMING

The conversion timing shown in Figure 3 does not result in the ADS7818 going into the power-down mode. If the conversion rate of the device is high (approaching 500kHz), then there is very little power that can be saved by using the power-down mode. However, since the power-down mode incurs no conversion penalty (the very first conversion is valid), at lower sample rates, significant power can be saved by allowing the device to go into power-down mode between conversions.

Figure 4 shows the typical method for placing the A/D into the power-down mode. If CONV is kept LOW during the conversion and is LOW at the start of the 13 clock cycle, then the device enters the power-down mode. It remains in this mode until the rising edge of CONV. Note that CONV must be HIGH for at least  $t_{ACQ}$  in order to sample the signal properly as well as to power-up the internal nodes.

There are two different methods for clocking the ADS7818. The first involves scaling the CLK input in relation to the conversion rate. For example, an 8MHz input clock and the timing shown in Figure 3 results in a 500kHz conversion rate. Likewise, a 1.6MHz clock would result in a 100kHz conversion rate. The second method involves keeping the clock input as close to the maximum clock rate as possible and starting conversions as needed. This timing is similar to that shown in Figure 4. As an example, a 50kHz conversion rate would require 160 clock periods per conversion instead of the 16 clock periods used at 500kHz.

The main distinction between the two is the amount of time that the ADS7818 remains in power down. In the first mode, the converter only remains in power down for a small number of clock periods (depending on how many clock periods there are per each conversion). As the conversion rate scales, the converter always spends the same percentage of time in power down. Since less power is drawn by the digital logic, there is a small decrease in power consumption, but it is very slight. This effect can be seen in the typical performance curve "Supply Current vs Sample Rate."

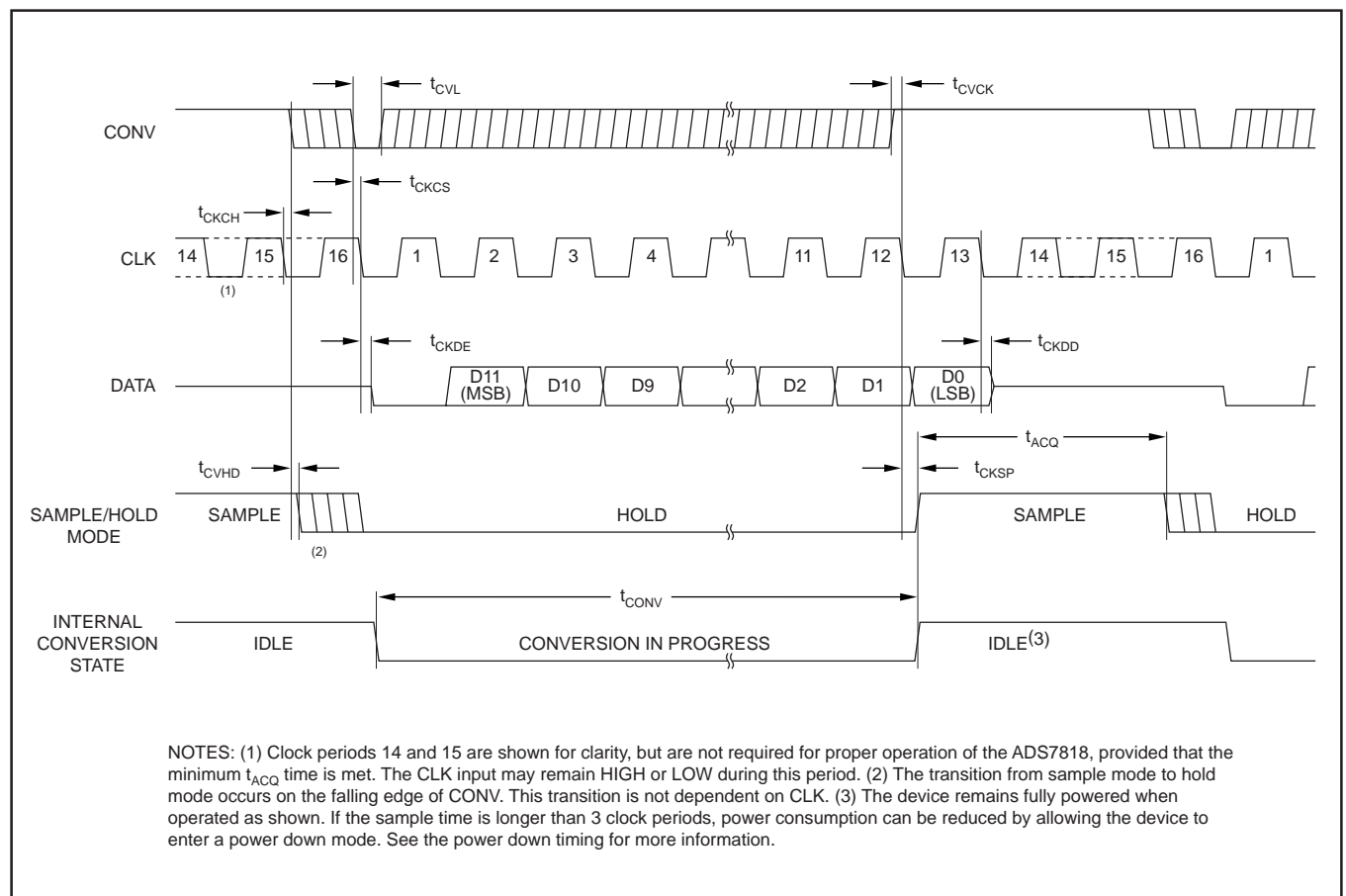

FIGURE 3. Basic Conversion Timing.

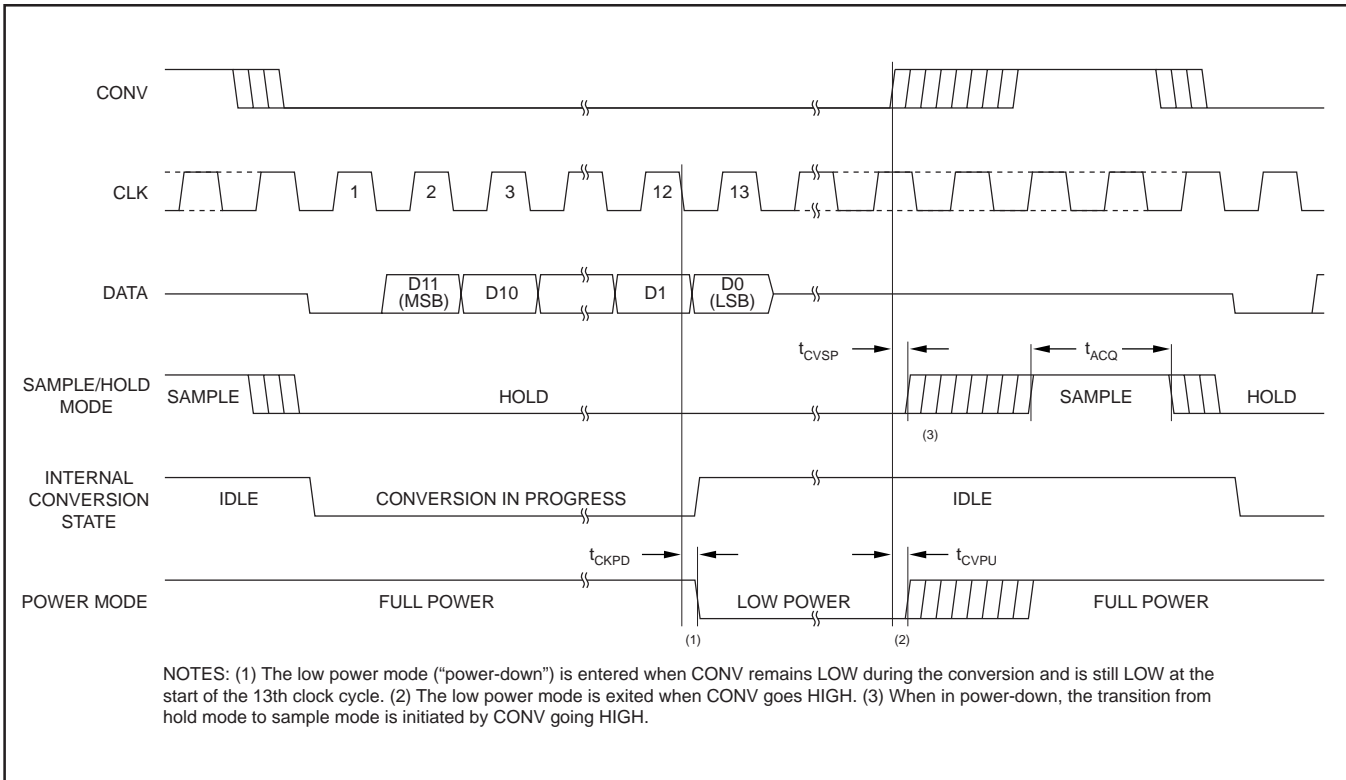

FIGURE 4. Power-down Timing.

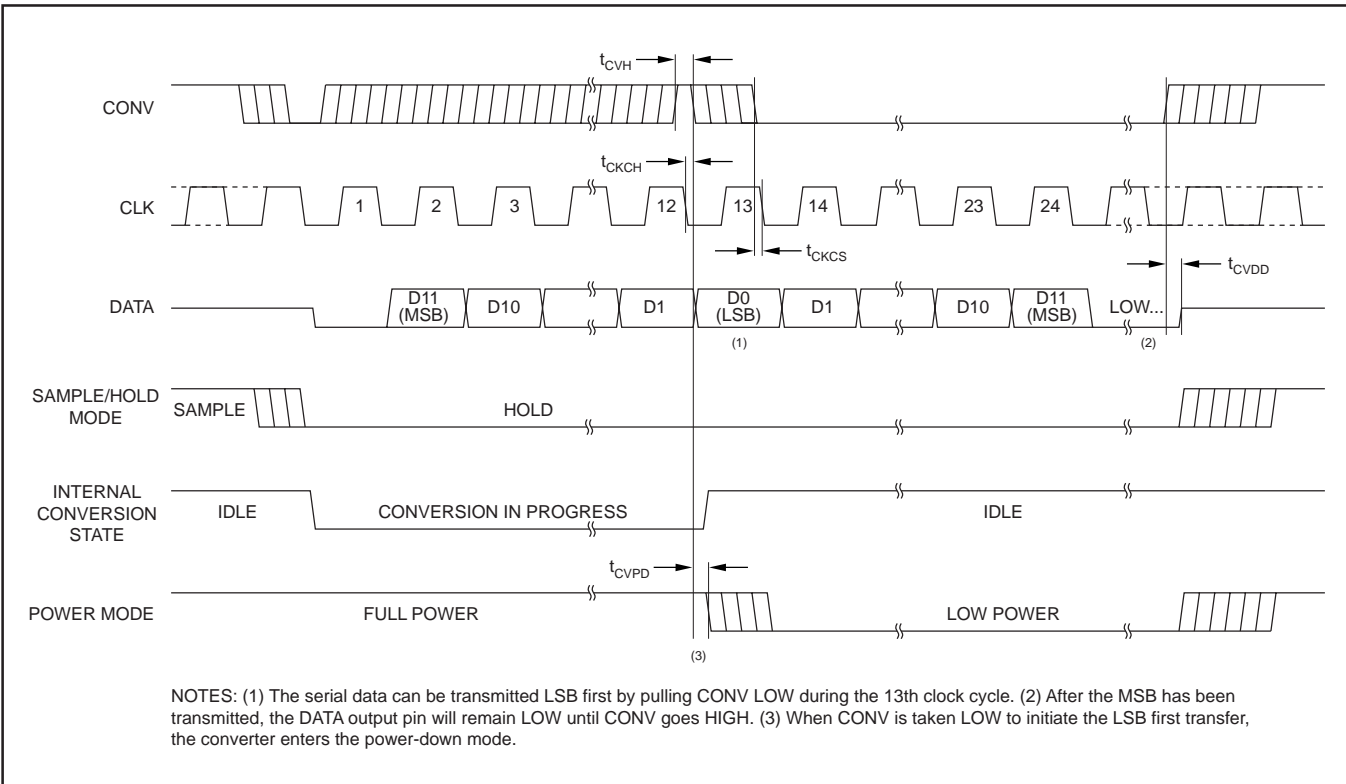

FIGURE 5. Serial Data "LSB-First" Timing.

In contrast, the second method (clocking at a fixed rate) means that each conversion takes X clock cycles. As the time between conversions get longer, the converter remains in power-down an increasing percentage of time. This re-

duces total power consumption by a considerable amount. For example, a 50kHz conversion rate results in roughly 1/10 of the power (minus the reference) that is used at a 500kHz conversion rate.

Table II offers a look at the two different modes of operation and the difference in power consumption.

| $f_{\text{SAMPLE}}$ | POWER WITH<br>CLK = 16 • $f_{\text{SAMPLE}}$ | POWER WITH<br>CLK = 8MHz |
|---------------------|--|--------------------------|
| 500kHz              | 11mW   | 11mW                     |
| 250kHz              | 10mW   | 7mW                      |
| 100kHz              | 9mW  | 4mW                      |

TABLE II. Power Consumption versus CLK Input.

### LSB FIRST DATA TIMING

Figure 5 shows a method to transmit the digital result in a least-significant bit (LSB) format. This mode is entered when CONV is pulled HIGH during the conversion (before the end of the 12th clock) and then pulled LOW during the 13th clock (when D0, the LSB, is being transmitted). The next 11 clocks then repeat the serial data, but in an LSB first format. The converter enters the power-down mode during the 13th clock and resumes normal operation when CONV goes HIGH.

### SHORT-CYCLE TIMING

The conversion currently in progress can be “short-cycled” with the technique shown in Figure 6. This term means that

the conversion will terminate immediately, before all 12-bits have been decided. This can be a very useful feature when a resolution of 12-bits is not needed. An example would be when the converter is being used to monitor an input voltage until some condition is met. At that time, the full resolution of the converter would then be used. Short-cycling the conversion can result in a faster conversion rate or lower power dissipation.

There are several very important items shown in Figure 6. The conversion currently in progress is terminated when CONV is taken HIGH during the conversion and then taken LOW prior to  $t_{\text{CKCH}}$  before the start of the 13th clock cycle. Note that if CONV goes LOW during the 13th clock cycle, then the LSB first mode will be entered (Figure 5). Also, when CONV goes LOW, the DATA output immediately transitions to high impedance. If the output bit that is present during that clock period is needed, CONV must not go LOW until the bit has been properly latched into the receiving logic.

### DATA FORMAT

The ADS7818 output data is in straight binary format as shown in Figure 7. This figure shows the ideal output code for the given input voltage and does not include the effects of offset, gain, or noise.

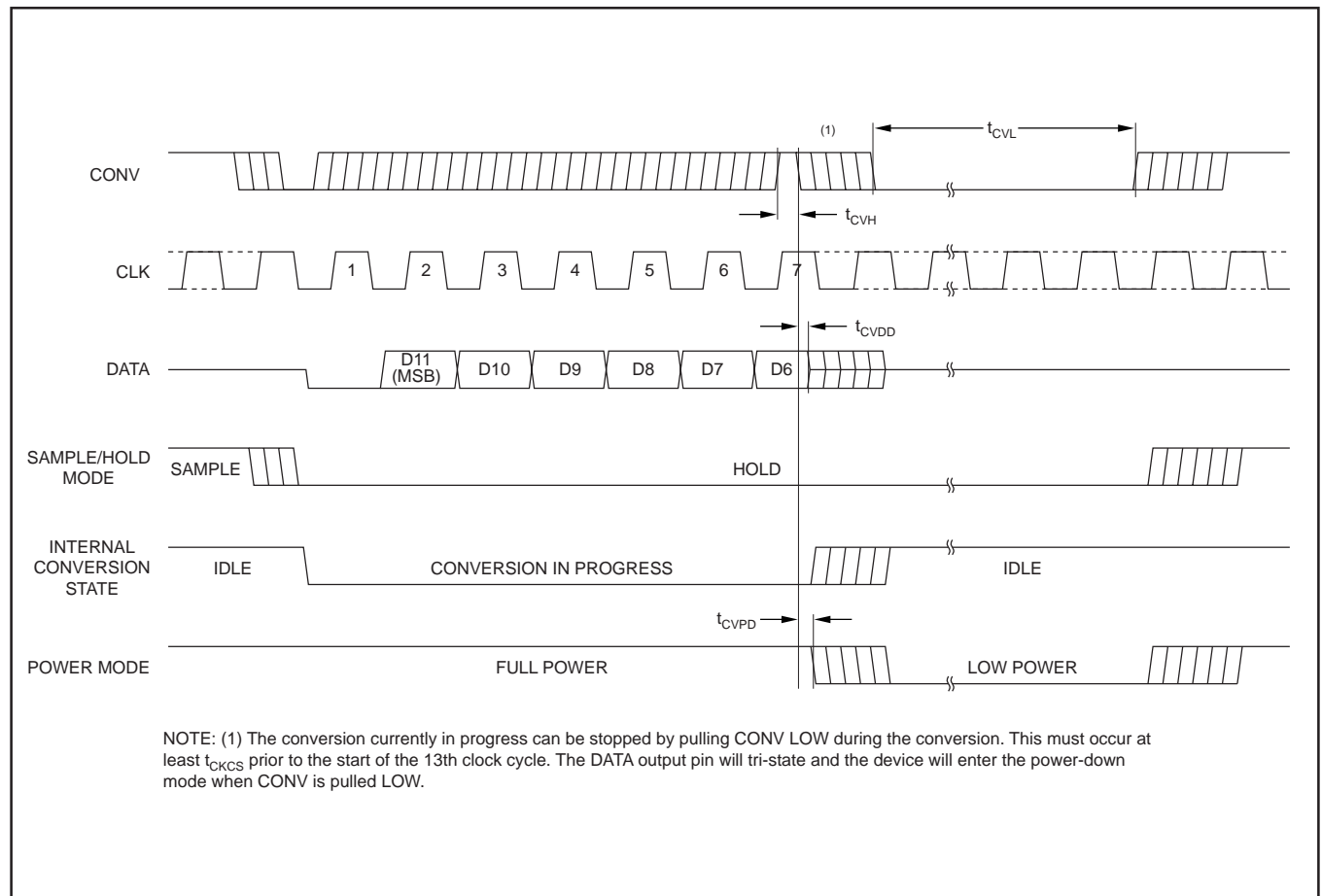

FIGURE 6. Short-cycle Timing.



With this in mind, power to the ADS7818 should be clean and well bypassed. A 0.1 $\mu$ F ceramic bypass capacitor should be placed as close to the device as possible. In addition, a 1 $\mu$ F to 10 $\mu$ F capacitor is recommended. If needed, an even larger capacitor and a 5 $\Omega$  or 10 $\Omega$  series resistor may be used to lowpass filter a noisy supply.

The ADS7818 draws very little current from an external reference on average as the reference voltage is internally buffered. However, glitches from the conversion process appear at the  $V_{REF}$  input and the reference source must be able to handle this. Whether the reference is internal or external, the  $V_{REF}$  pin should be bypassed with a 0.1 $\mu$ F

capacitor. An additional larger capacitor may also be used, if desired. If the reference voltage is external and originates from an op-amp, make sure that it can drive the bypass capacitor or capacitors without oscillation.

The GND pin should be connected to a clean ground point. In many cases, this will be the “analog” ground. Avoid connections which are too near the grounding point of a microcontroller or digital signal processor. If needed, run a ground trace directly from the converter to the power supply entry point. The ideal layout will include an analog ground plane dedicated to the converter and associated analog circuitry.

**PACKAGING INFORMATION**

| Orderable Device | Status<br>(1) | Package Type | Package Drawing | Pins | Package Qty | Eco Plan<br>(2)         | Lead/Ball Finish<br>(6) | MSL Peak Temp<br>(3) | Op Temp (°C) | Device Marking<br>(4/5) | Samples                 |
|------------------|---------------|--------------|-----------------|------|-------------|-------------------------|-------------------------|----------------------|--------------|-------------------------|-------------------------|
| ADS7818E/250     | ACTIVE        | VSSOP        | DGK             | 8    | 250         | Green (RoHS & no Sb/Br) | CU NIPDAUAG             | Level-2-260C-1 YEAR  | -40 to 85    | A18                     | <a href="#">Samples</a> |
| ADS7818E/250G4   | ACTIVE        | VSSOP        | DGK             | 8    | 250         | Green (RoHS & no Sb/Br) | CU NIPDAUAG             | Level-2-260C-1 YEAR  | -40 to 85    | A18                     | <a href="#">Samples</a> |
| ADS7818E/2K5     | ACTIVE        | VSSOP        | DGK             | 8    | 2500        | Green (RoHS & no Sb/Br) | CU NIPDAUAG             | Level-2-260C-1 YEAR  | -40 to 85    | A18                     | <a href="#">Samples</a> |
| ADS7818E/2K5G4   | ACTIVE        | VSSOP        | DGK             | 8    | 2500        | Green (RoHS & no Sb/Br) | CU NIPDAUAG             | Level-2-260C-1 YEAR  | -40 to 85    | A18                     | <a href="#">Samples</a> |
| ADS7818EB/250    | ACTIVE        | VSSOP        | DGK             | 8    | 250         | Green (RoHS & no Sb/Br) | CU NIPDAUAG             | Level-2-260C-1 YEAR  | -40 to 85    | A18                     | <a href="#">Samples</a> |
| ADS7818EB/250G4  | ACTIVE        | VSSOP        | DGK             | 8    | 250         | Green (RoHS & no Sb/Br) | CU NIPDAUAG             | Level-2-260C-1 YEAR  | -40 to 85    | A18                     | <a href="#">Samples</a> |
| ADS7818EB/2K5    | ACTIVE        | VSSOP        | DGK             | 8    | 2500        | Green (RoHS & no Sb/Br) | CU NIPDAUAG             | Level-2-260C-1 YEAR  | -40 to 85    | A18                     | <a href="#">Samples</a> |
| ADS7818EB/2K5G4  | ACTIVE        | VSSOP        | DGK             | 8    | 2500        | Green (RoHS & no Sb/Br) | CU NIPDAUAG             | Level-2-260C-1 YEAR  | -40 to 85    | A18                     | <a href="#">Samples</a> |
| ADS7818P         | LIFEBUY       | PDIP         | P               | 8    | 50          | Green (RoHS & no Sb/Br) | CU NIPDAU               | N / A for Pkg Type   | -40 to 85    | ADS7818P                |                         |
| ADS7818PB        | ACTIVE        | PDIP         | P               | 8    | 50          | Green (RoHS & no Sb/Br) | CU NIPDAU               | N / A for Pkg Type   | -40 to 85    | ADS7818P<br>B           | <a href="#">Samples</a> |

(1) The marketing status values are defined as follows:

**ACTIVE:** Product device recommended for new designs.

**LIFEBUY:** TI has announced that the device will be discontinued, and a lifetime-buy period is in effect.

**NRND:** Not recommended for new designs. Device is in production to support existing customers, but TI does not recommend using this part in a new design.

**PREVIEW:** Device has been announced but is not in production. Samples may or may not be available.

**OBSOLETE:** TI has discontinued the production of the device.

(2) **RoHS:** TI defines "RoHS" to mean semiconductor products that are compliant with the current EU RoHS requirements for all 10 RoHS substances, including the requirement that RoHS substance do not exceed 0.1% by weight in homogeneous materials. Where designed to be soldered at high temperatures, "RoHS" products are suitable for use in specified lead-free processes. TI may reference these types of products as "Pb-Free".

**RoHS Exempt:** TI defines "RoHS Exempt" to mean products that contain lead but are compliant with EU RoHS pursuant to a specific EU RoHS exemption.

**Green:** TI defines "Green" to mean the content of Chlorine (Cl) and Bromine (Br) based flame retardants meet JS709B low halogen requirements of <=1000ppm threshold. Antimony trioxide based flame retardants must also meet the <=1000ppm threshold requirement.

(3) MSL, Peak Temp. - The Moisture Sensitivity Level rating according to the JEDEC industry standard classifications, and peak solder temperature.

(4) There may be additional marking, which relates to the logo, the lot trace code information, or the environmental category on the device.

(5) Multiple Device Markings will be inside parentheses. Only one Device Marking contained in parentheses and separated by a "~" will appear on a device. If a line is indented then it is a continuation of the previous line and the two combined represent the entire Device Marking for that device.

(6) Lead/Ball Finish - Orderable Devices may have multiple material finish options. Finish options are separated by a vertical ruled line. Lead/Ball Finish values may wrap to two lines if the finish value exceeds the maximum column width.

**Important Information and Disclaimer:**The information provided on this page represents TI's knowledge and belief as of the date that it is provided. TI bases its knowledge and belief on information provided by third parties, and makes no representation or warranty as to the accuracy of such information. Efforts are underway to better integrate information from third parties. TI has taken and continues to take reasonable steps to provide representative and accurate information but may not have conducted destructive testing or chemical analysis on incoming materials and chemicals. TI and TI suppliers consider certain information to be proprietary, and thus CAS numbers and other limited information may not be available for release.

In no event shall TI's liability arising out of such information exceed the total purchase price of the TI part(s) at issue in this document sold by TI to Customer on an annual basis.

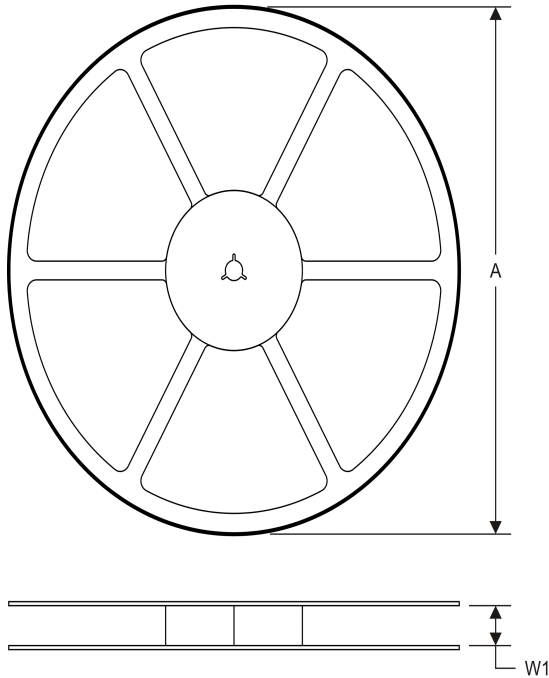
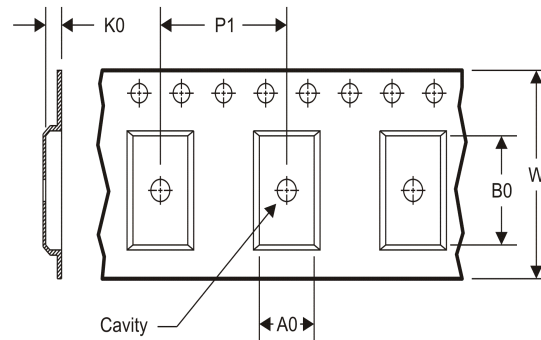
**TAPE AND REEL INFORMATION**
**REEL DIMENSIONS**

**TAPE DIMENSIONS**

|    |   |
|----|---|
| A0 | Dimension designed to accommodate the component width     |
| B0 | Dimension designed to accommodate the component length    |
| K0 | Dimension designed to accommodate the component thickness |
| W  | Overall width of the carrier tape                         |
| P1 | Pitch between successive cavity centers                   |

**TAPE AND REEL INFORMATION**

\*All dimensions are nominal

| Device        | Package Type | Package Drawing | Pins | SPQ  | Reel Diameter (mm) | Reel Width W1 (mm) | A0 (mm) | B0 (mm) | K0 (mm) | P1 (mm) | W (mm) | Pin1 Quadrant |
|---------------|--------------|-----------------|------|------|--------------------|--------------------|---------|---------|---------|---------|--------|---------------|
| ADS7818E/250  | VSSOP        | DGK             | 8    | 250  | 180.0              | 12.4               | 5.3     | 3.4     | 1.4     | 8.0     | 12.0   | Q1            |
| ADS7818E/2K5  | VSSOP        | DGK             | 8    | 2500 | 330.0              | 12.4               | 5.3     | 3.4     | 1.4     | 8.0     | 12.0   | Q1            |
| ADS7818EB/250 | VSSOP        | DGK             | 8    | 250  | 180.0              | 12.4               | 5.3     | 3.4     | 1.4     | 8.0     | 12.0   | Q1            |
| ADS7818EB/2K5 | VSSOP        | DGK             | 8    | 2500 | 330.0              | 12.4               | 5.3     | 3.4     | 1.4     | 8.0     | 12.0   | Q1            |

**TAPE AND REEL BOX DIMENSIONS**

\*All dimensions are nominal

| Device        | Package Type | Package Drawing | Pins | SPQ  | Length (mm) | Width (mm) | Height (mm) |
|---------------|--------------|-----------------|------|------|-------------|------------|-------------|
| ADS7818E/250  | VSSOP        | DGK             | 8    | 250  | 210.0       | 185.0      | 35.0        |
| ADS7818E/2K5  | VSSOP        | DGK             | 8    | 2500 | 367.0       | 367.0      | 35.0        |
| ADS7818EB/250 | VSSOP        | DGK             | 8    | 250  | 210.0       | 185.0      | 35.0        |
| ADS7818EB/2K5 | VSSOP        | DGK             | 8    | 2500 | 367.0       | 367.0      | 35.0        |

P (R-PDIP-T8)

PLASTIC DUAL-IN-LINE PACKAGE

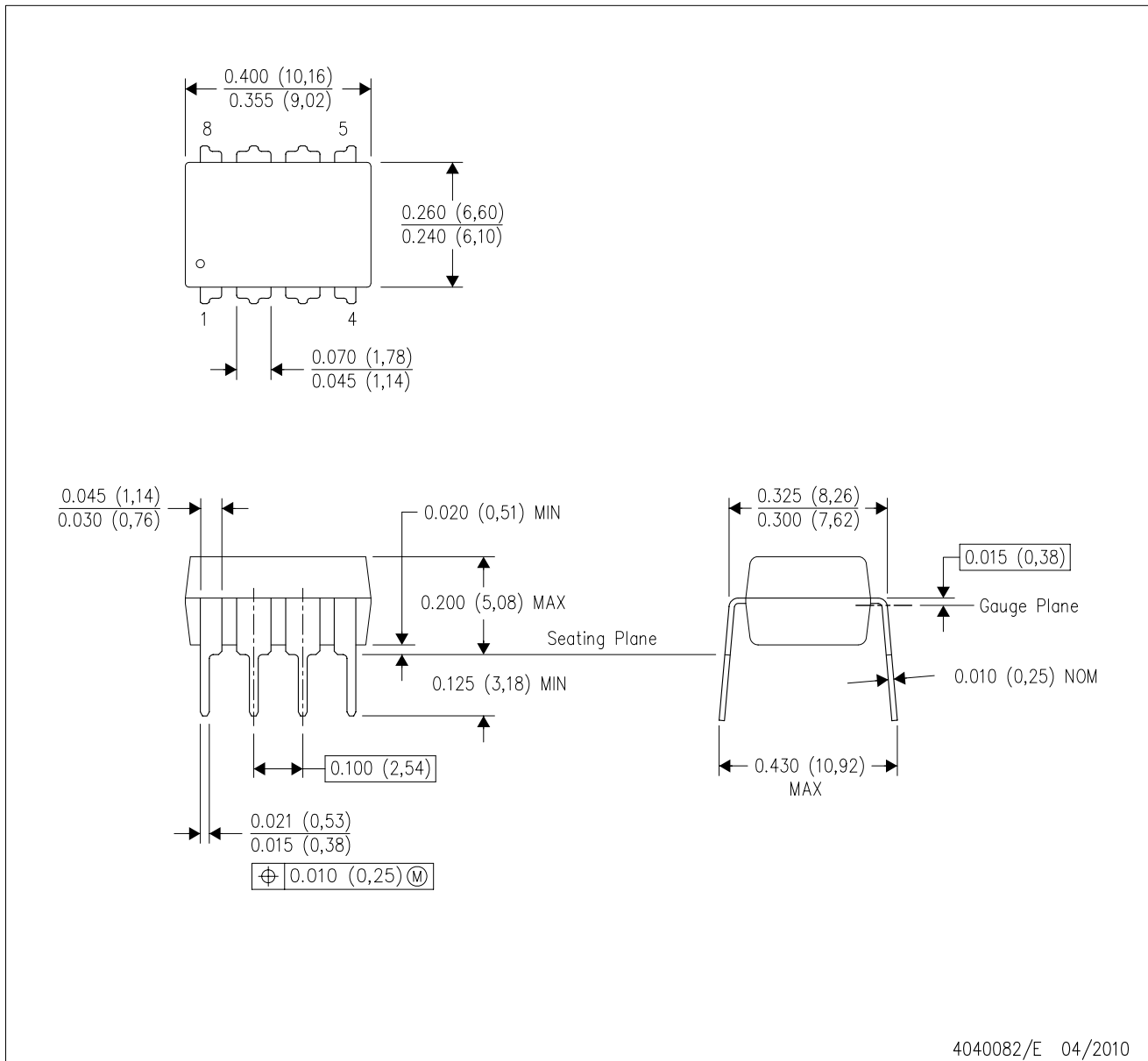

- NOTES:
- A. All linear dimensions are in inches (millimeters).
  - B. This drawing is subject to change without notice.
  - C. Falls within JEDEC MS-001 variation BA.





- NOTES:
- A. All linear dimensions are in millimeters.
  - B. This drawing is subject to change without notice.
  - C. Publication IPC-7351 is recommended for alternate designs.
  - D. Laser cutting apertures with trapezoidal walls and also rounding corners will offer better paste release. Customers should contact their board assembly site for stencil design recommendations. Refer to IPC-7525 for other stencil recommendations.
  - E. Customers should contact their board fabrication site for solder mask tolerances between and around signal pads.

## IMPORTANT NOTICE AND DISCLAIMER

TI PROVIDES TECHNICAL AND RELIABILITY DATA (INCLUDING DATASHEETS), DESIGN RESOURCES (INCLUDING REFERENCE DESIGNS), APPLICATION OR OTHER DESIGN ADVICE, WEB TOOLS, SAFETY INFORMATION, AND OTHER RESOURCES "AS IS" AND WITH ALL FAULTS, AND DISCLAIMS ALL WARRANTIES, EXPRESS AND IMPLIED, INCLUDING WITHOUT LIMITATION ANY IMPLIED WARRANTIES OF MERCHANTABILITY, FITNESS FOR A PARTICULAR PURPOSE OR NON-INFRINGEMENT OF THIRD PARTY INTELLECTUAL PROPERTY RIGHTS.

These resources are intended for skilled developers designing with TI products. You are solely responsible for (1) selecting the appropriate TI products for your application, (2) designing, validating and testing your application, and (3) ensuring your application meets applicable standards, and any other safety, security, or other requirements. These resources are subject to change without notice. TI grants you permission to use these resources only for development of an application that uses the TI products described in the resource. Other reproduction and display of these resources is prohibited. No license is granted to any other TI intellectual property right or to any third party intellectual property right. TI disclaims responsibility for, and you will fully indemnify TI and its representatives against, any claims, damages, costs, losses, and liabilities arising out of your use of these resources.

TI's products are provided subject to TI's Terms of Sale ([www.ti.com/legal/termsofsale.html](http://www.ti.com/legal/termsofsale.html)) or other applicable terms available either on [ti.com](http://ti.com) or provided in conjunction with such TI products. TI's provision of these resources does not expand or otherwise alter TI's applicable warranties or warranty disclaimers for TI products.

Mailing Address: Texas Instruments, Post Office Box 655303, Dallas, Texas 75265  
Copyright © 2019, Texas Instruments Incorporated

## Looking for pricing, stock, or lifecycle information?

Click below to explore more details on WIN SOURCE:

 [View ADS7818E/250G4 on WIN SOURCE](#)

 [Texas Instruments](#) Information

## Optimize Your Supply Chain with WIN SOURCE Solutions

-  Global Sourcing Solution
-  Obsolete Management
-  Cost Control Management
-  Shortage Management
-  Alternative Solution
-  Excess Inventory Management