



### FEATURES

#### Operating RF frequency

30 MHz to 2 GHz

#### LO input at $2 \times f_{LO}$

60 MHz to 4 GHz

#### Input IP3: 31 dBm at 900 MHz

#### Input IP2: 62 dBm at 900 MHz

#### Input P1dB: 13 dBm at 900 MHz

#### Noise figure (NF)

12.0 dB at 140 MHz

14.7 dB at 900 MHz

#### Voltage conversion gain > 4 dB

#### Quadrature demodulation accuracy

Phase accuracy  $\sim 0.4^\circ$

Amplitude balance  $\sim 0.05$  dB

#### Demodulation bandwidth $\sim 240$ MHz

#### Baseband I/Q drive 2 V p-p into 200 $\Omega$

#### Single 5 V supply

### APPLICATIONS

QAM/QPSK RF/IF demodulators

W-CDMA/CDMA/CDMA2000/GSM

Microwave point-to-(multi)point radios

Broadband wireless and WiMAX

Broadband CATVs

### GENERAL DESCRIPTION

The [ADL5387](#) is a broadband quadrature I/Q demodulator that covers an RF/IF input frequency range from 30 MHz to 2 GHz. With a NF = 13.2 dB, IP1dB = 12.7 dBm, and IIP3 = 32 dBm at 450 MHz, the [ADL5387](#) demodulator offers outstanding dynamic range suitable for the demanding infrastructure direct-conversion requirements. The differential RF/IF inputs provide a well-behaved broadband input impedance of 50  $\Omega$  and are best driven from a 1:1 balun for optimum performance.

Ultrabroadband operation is achieved with a divide-by-2 method for local oscillator (LO) quadrature generation. Over a wide range of LO levels, excellent demodulation accuracy is achieved with amplitude and phase balances  $\sim 0.05$  dB and  $\sim 0.4^\circ$ , respectively. The demodulated in-phase (I) and quadrature (Q) differential outputs are fully buffered and provide a voltage conversion gain of >4 dB. The buffered baseband outputs are capable of driving a 2 V p-p differential signal into 200  $\Omega$ .

### FUNCTIONAL BLOCK DIAGRAM

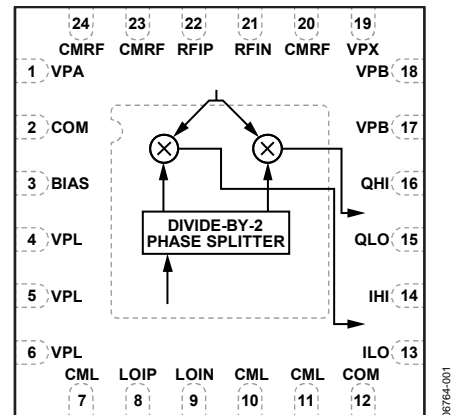

Figure 1.

The fully balanced design minimizes effects from second-order distortion. The leakage from the LO port to the RF port is  $< -70$  dBc. Differential dc-offsets at the I and Q outputs are  $< 10$  mV. Both of these factors contribute to the excellent IIP2 specifications  $> 60$  dBm.

The [ADL5387](#) operates off a single 4.75 V to 5.25 V supply. The supply current is adjustable with an external resistor from the BIAS pin to ground.

The [ADL5387](#) is fabricated using the Analog Devices, Inc., advanced silicon-germanium bipolar process and is available in a 24-lead exposed paddle LFCSP.

Rev. C

[Document Feedback](#)

Information furnished by Analog Devices is believed to be accurate and reliable. However, no responsibility is assumed by Analog Devices for its use, nor for any infringements of patents or other rights of third parties that may result from its use. Specifications subject to change without notice. No license is granted by implication or otherwise under any patent or patent rights of Analog Devices. Trademarks and registered trademarks are the property of their respective owners.

## TABLE OF CONTENTS

|   |    |  |    |
|---|----|--|----|
| Features .....                                    | 1  | Mixers .....                                   | 15 |
| Applications .....                                | 1  | Emitter Follower Buffers .....                 | 15 |
| Functional Block Diagram .....                    | 1  | Bias Circuit .....                             | 15 |
| General Description .....                         | 1  | Applications Information .....                 | 16 |
| Revision History .....                            | 2  | Basic Connections .....                        | 16 |
| Specifications .....                              | 3  | Power Supply .....                             | 16 |
| Absolute Maximum Ratings .....                    | 5  | Local Oscillator (LO) Input .....              | 16 |
| ESD Caution .....                                 | 5  | RF Input .....                                 | 17 |
| Pin Configuration and Function Descriptions ..... | 6  | Baseband Outputs .....                         | 17 |
| Typical Performance Characteristics .....         | 7  | Error Vector Magnitude (EVM) Performance ..... | 18 |
| Distributions for $f_{RF} = 140$ MHz .....        | 11 | Low IF Image Rejection .....                   | 19 |
| Distributions for $f_{RF} = 450$ MHz .....        | 12 | Example Baseband Interface .....               | 19 |
| Distributions for $f_{RF} = 900$ MHz .....        | 13 | Characterization Setups .....                  | 22 |
| Distributions for $f_{RF} = 1900$ MHz .....       | 14 | Evaluation Board .....                         | 24 |
| Circuit Description .....                         | 15 | Outline Dimensions .....                       | 27 |
| LO Interface .....                                | 15 | Ordering Guide .....                           | 27 |
| V-to-I Converter .....                            | 15 |  |    |

## REVISION HISTORY

### 8/2016—Rev. B to Rev. C

|                                   |            |
|-----------------------------------|------------|
| Changed CP-24-2 to CP-24-14 ..... | Throughout |
| Updated Outline Dimensions .....  | 27         |
| Changes to Ordering Guide .....   | 27         |

### 10/2013—Rev. A to Rev. B

|  |    |
|--|----|
| Added Figure 4, Figure 6, and Figure 8; Renumbered<br>Sequentially ..... | 7  |
| Moved Figure 9, Added Figure 10 .....                                    | 8  |
| Changes to Figure 25 .....   | 11 |
| Changes to Figure 31 .....   | 12 |
| Updated Outline Dimensions .....   | 27 |
| Changes to Ordering Guide .....  | 27 |

### 5/2013—Rev. 0 to Rev. A

|  |    |
|--|----|
| Changed Minimum Operating RF Frequency from 50 MHz to<br>30 MHz (Throughout) .....         | 1  |
| Changed Minimum LO Input at $2 \times f_{LO}$ from 100 MHz to<br>60 MHz (Throughout) ..... | 1  |
| Added Dynamic Performance @ RF = 30 MHz Parameters .....                                   | 3  |
| Changes to Local Oscillator (LO) Input Section .....                                       | 15 |
| Changes to Table 4 .....   | 24 |
| Updated Outline Dimensions .....   | 26 |
| Changes to Ordering Guide .....  | 26 |

### 10/2007—Revision 0: Initial Version

## SPECIFICATIONS

$V_S = 5\text{ V}$ ,  $T_A = 25^\circ\text{C}$ ,  $f_{RF} = 900\text{ MHz}$ ,  $f_{IF} = 4.5\text{ MHz}$ ,  $P_{LO} = 0\text{ dBm}$ , BIAS pin open,  $Z_O = 50\ \Omega$ , unless otherwise noted, baseband outputs differentially loaded with  $450\ \Omega$ .

Table 1.

| Parameter                              | Condition   | Min  | Typ        | Max  | Unit     |
|--|---|------|------------|------|----------|
| OPERATING CONDITIONS                   |   |      |            |      |          |
| LO Frequency Range                     | External input = 2xLO frequency   | 0.06 |            | 4    | GHz      |
| RF Frequency Range                     |   | 0.03 |            | 2    | GHz      |
| LO INPUT                               |   |      |            |      |          |
| Input Return Loss                      | LOIP, LOIN<br>AC-coupled into LOIP with LOIN bypassed,<br>measured at 2 GHz             |      | -10        |      | dB       |
| LO Input Level                         |   | -6   | 0          | +6   | dBm      |
| I/Q BASEBAND OUTPUTS                   |   |      |            |      |          |
| Voltage Conversion Gain                | QHI, QLO, IHI, ILO<br>450 $\Omega$ differential load on I and Q outputs<br>(at 900 MHz) |      | 4.3        |      | dB       |
|  | 200 $\Omega$ differential load on I and Q outputs<br>(at 900 MHz)                       |      | 3.2        |      | dB       |
| Demodulation Bandwidth                 | 1 V p-p signal 3 dB bandwidth<br>at 900 MHz   |      | 240        |      | MHz      |
| Quadrature Phase Error                 |   |      | 0.4        |      | Degrees  |
| I/Q Amplitude Imbalance                |   |      | 0.1        |      | dB       |
| Output DC Offset (Differential)        | 0 dBm LO input  |      | $\pm 5$    |      | mV       |
| Output Common-Mode                     |   |      | VPOS - 2.8 |      | V        |
| 0.1 dB Gain Flatness                   |   |      | 40         |      | MHz      |
| Output Swing                           | Differential 200 $\Omega$ load  |      | 2          |      | V p-p    |
| Peak Output Current                    | Each pin  |      | 12         |      | mA       |
| POWER SUPPLIES                         |   |      |            |      |          |
| Voltage                                | VPA, VPL, VPB, VPX  | 4.75 |            | 5.25 | V        |
| Current                                | BIAS pin open<br>RBIAS = 4 k $\Omega$   |      | 180<br>157 |      | mA<br>mA |
| DYNAMIC PERFORMANCE at RF = 30 MHz     |   |      |            |      |          |
|  | RFIP, RFIN, L1, L2 = 680 nH, C10, C11 = 0.01 $\mu\text{F}^1$                            |      |            |      |          |
| Conversion Gain                        |   |      | 4.5        |      | dB       |
| Input P1dB (IP1dB)                     |   |      | 12         |      | dBm      |
| Second-Order Input Intercept (IIP2)    | -5 dBm each input tone  |      | 69         |      | dBm      |
| Third-Order Input Intercept (IIP3)     | -5 dBm each input tone  |      | 31         |      | dBm      |
| I/Q Magnitude Imbalance                |   |      | 0.1        |      | dB       |
| I/Q Phase Imbalance                    |   |      | 0.3        |      | Degrees  |
| DYNAMIC PERFORMANCE at RF = 140 MHz    |   |      |            |      |          |
| Conversion Gain                        | RFIP, RFIN  |      | 4.7        |      | dB       |
| Input P1dB (IP1dB)                     |   |      | 13         |      | dBm      |
| Second-Order Input Intercept (IIP2)    | -5 dBm each input tone  |      | 67         |      | dBm      |
| Third-Order Input Intercept (IIP3)     | -5 dBm each input tone  |      | 31         |      | dBm      |
| LO to RF                               | RFIN, RFIP terminated in 50 $\Omega$ , 1xLO<br>appearing at the RF port                 |      | -100       |      | dBm      |
| RF to LO                               | LOIN, LOIP terminated in 50 $\Omega$  |      | -95        |      | dBc      |
| I/Q Magnitude Imbalance                |   |      | 0.05       |      | dB       |
| I/Q Phase Imbalance                    |   |      | 0.2        |      | Degrees  |
| LO to I/Q                              | RFIN, RFIP terminated in 50 $\Omega$ , 1xLO<br>appearing at the BB port                 |      | -39        |      | dBm      |
| Noise Figure                           |   |      | 12.0       |      | dB       |
| Noise Figure under Blocking Conditions | With a -5 dBm interferer 5 MHz away   |      | 14.4       |      | dB       |

| Parameter                                   | Condition  | Min | Typ  | Max | Unit    |
|---|--|-----|------|-----|---------|
| <b>DYNAMIC PERFORMANCE at RF = 450 MHz</b>  |  |     |      |     |         |
| Conversion Gain                             |  |     | 4.4  |     | dB      |
| Input P1dB (IP1dB)                          |  |     | 12.7 |     | dBm     |
| Second-Order Input Intercept (IIP2)         | -5 dBm each input tone   |     | 69.2 |     | dBm     |
| Third-Order Input Intercept (IIP3)          | -5 dBm each input tone   |     | 32.8 |     | dBm     |
| LO to RF                                    | RFIN, RFIP terminated in 50 $\Omega$ , 1xLO appearing at the RF port |     | -87  |     | dBm     |
| RF to LO                                    | LOIN, LOIP terminated in 50 $\Omega$                                 |     | -90  |     | dBc     |
| I/Q Magnitude Imbalance                     |  |     | 0.05 |     | dB      |
| I/Q Phase Imbalance                         |  |     | 0.6  |     | Degrees |
| LO to I/Q                                   | RFIN, RFIP terminated in 50 $\Omega$ , 1xLO appearing at the BB port |     | -38  |     | dBm     |
| Noise Figure                                |  |     | 13.2 |     | dB      |
| <b>DYNAMIC PERFORMANCE at RF = 900 MHz</b>  |  |     |      |     |         |
| Conversion Gain                             |  |     | 4.3  |     | dB      |
| Input P1dB (IP1dB)                          |  |     | 12.8 |     | dBm     |
| Second-Order Input Intercept (IIP2)         | -5 dBm each input tone   |     | 61.7 |     | dBm     |
| Third-Order Input Intercept (IIP3)          | -5 dBm each input tone   |     | 31.2 |     | dBm     |
| LO to RF                                    | RFIN, RFIP terminated in 50 $\Omega$ , 1xLO appearing at the RF port |     | -79  |     | dBm     |
| RF to LO                                    | LOIN, LOIP terminated in 50 $\Omega$                                 |     | -88  |     | dBc     |
| I/Q Magnitude Imbalance                     |  |     | 0.05 |     | dB      |
| I/Q Phase Imbalance                         |  |     | 0.2  |     | Degrees |
| LO to I/Q                                   | RFIN, RFIP terminated in 50 $\Omega$ , 1XLO appearing at the BB port |     | -41  |     | dBm     |
| Noise Figure                                |  |     | 14.7 |     | dB      |
| Noise Figure under Blocking Conditions      | With a -5 dBm interferer 5 MHz away                                  |     | 15.8 |     | dB      |
| <b>DYNAMIC PERFORMANCE at RF = 1900 MHz</b> |  |     |      |     |         |
| Conversion Gain                             |  |     | 3.8  |     | dB      |
| Input P1dB (IP1dB)                          |  |     | 12.8 |     | dBm     |
| Second-Order Input Intercept (IIP2)         | -5 dBm each input tone   |     | 59.8 |     | dBm     |
| Third-Order Input Intercept (IIP3)          | -5 dBm each input tone   |     | 27.4 |     | dBm     |
| LO to RF                                    | RFIN, RFIP terminated in 50 $\Omega$ , 1xLO appearing at the RF port |     | -75  |     | dBm     |
| RF to LO                                    | LOIN, LOIP terminated in 50 $\Omega$                                 |     | -70  |     | dBc     |
| I/Q Magnitude Imbalance                     |  |     | 0.05 |     | dB      |
| I/Q Phase Imbalance                         |  |     | 0.3  |     | Degrees |
| LO to I/Q                                   | RFIN, RFIP terminated in 50 $\Omega$ , 1xLO appearing at the BB port |     | -43  |     | dBm     |
| Noise Figure                                |  |     | 16.5 |     | dB      |
| Noise Figure under Blocking Conditions      | With a -5 dBm interferer 5 MHz away                                  |     | 18.7 |     | dB      |

<sup>1</sup> See Figure 64 for locations of L1, L2, C10, and C11.

## ABSOLUTE MAXIMUM RATINGS

Table 2.

| Parameter                          | Rating                    |
|------------------------------------|---------------------------|
| Supply Voltage VPOS1, VPOS2, VPOS3 | 5.5 V                     |
| LO Input Power                     | 13 dBm (re: 50 $\Omega$ ) |
| RF/IF Input Power                  | 15 dBm (re: 50 $\Omega$ ) |
| Internal Maximum Power Dissipation | 1100 mW                   |
| $\theta_{JA}$                      | 54°C/W                    |
| Maximum Junction Temperature       | 150°C                     |
| Operating Temperature Range        | -40°C to +85°C            |
| Storage Temperature Range          | -65°C to +125°C           |

Stresses at or above those listed under Absolute Maximum Ratings may cause permanent damage to the product. This is a stress rating only; functional operation of the product at these or any other conditions above those indicated in the operational section of this specification is not implied. Operation beyond the maximum operating conditions for extended periods may affect product reliability.

### ESD CAUTION



**ESD (electrostatic discharge) sensitive device.** Charged devices and circuit boards can discharge without detection. Although this product features patented or proprietary protection circuitry, damage may occur on devices subjected to high energy ESD. Therefore, proper ESD precautions should be taken to avoid performance degradation or loss of functionality.

## PIN CONFIGURATION AND FUNCTION DESCRIPTIONS

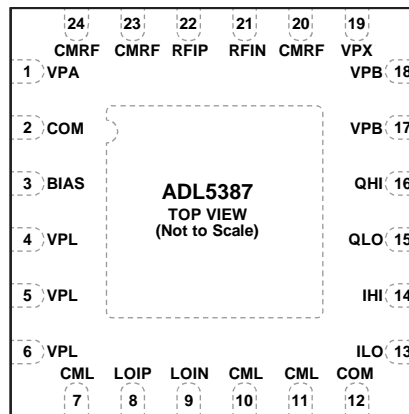

NOTES  
 1. CONNECT THE EXPOSED PADDLE TO A LOW IMPEDANCE GROUND PLANE.

06764-002

Figure 2. Pin Configuration

Table 3. Pin Function Descriptions

| Pin No.                    | Mnemonic           | Description   |
|----------------------------|--------------------|---|
| 1, 4 to 6, 17 to 19        | VPA, VPL, VPB, VPX | Supply. Positive supply for LO, IF, biasing and baseband sections, respectively. These pins should be decoupled to board ground using appropriate sized capacitors.   |
| 2, 7, 10 to 12, 20, 23, 24 | COM, CML, CMRF     | Ground. Connect to a low impedance ground plane.  |
| 3                          | BIAS               | Bias Control. A resistor can be connected between BIAS and COM to reduce the mixer core current. The default setting for this pin is open.  |
| 8, 9                       | LOIP, LOIN         | Local Oscillator. External LO input is at 2xLO frequency. A single-ended LO at 0 dBm can be applied through a 1000 pF capacitor to LOIP. LOIN should be ac-grounded, also using a 1000 pF. These inputs can also be driven differentially through a balun (recommended balun is M/A-COM ETC1-1-13). |
| 13 to 16                   | ILO, IHI, QLO, QHI | I-Channel and Q-Channel Mixer Baseband Outputs. These outputs have a 50 Ω differential output impedance (25 Ω per pin). The bias level on these pins is equal to VPOS – 2.8 V. Each output pair can swing 2 V p-p (differential) into a load of 200 Ω. Output 3 dB bandwidth is 240 MHz.            |
| 21, 22                     | RFIN, RFIP         | RF Input. A single-ended 50 Ω signal can be applied to the RF inputs through a 1:1 balun (recommended balun is M/A-COM ETC1-1-13). Ground-referenced inductors must also be connected to RFIP and RFIN (recommended values = 120 nH).   |
|                            | EP                 | Exposed Paddle. Connect to a low impedance ground plane.  |

# TYPICAL PERFORMANCE CHARACTERISTICS

$V_S = 5\text{ V}$ ,  $T_A = 25^\circ\text{C}$ , LO drive level = 0 dBm,  $R_{BIAS} = \text{open}$ , unless otherwise noted.

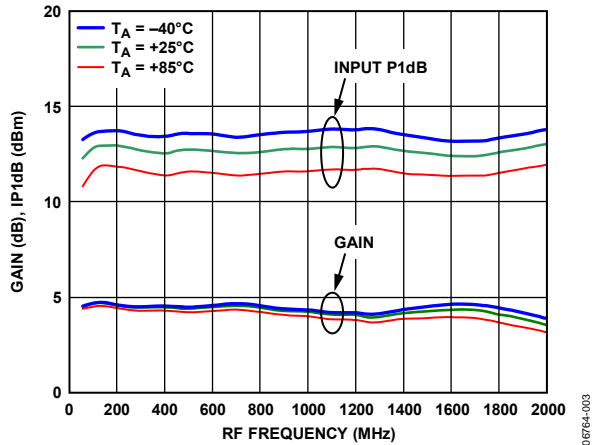

Figure 3. Conversion Gain and Input 1 dB Compression Point (IP1dB) vs. RF Frequency

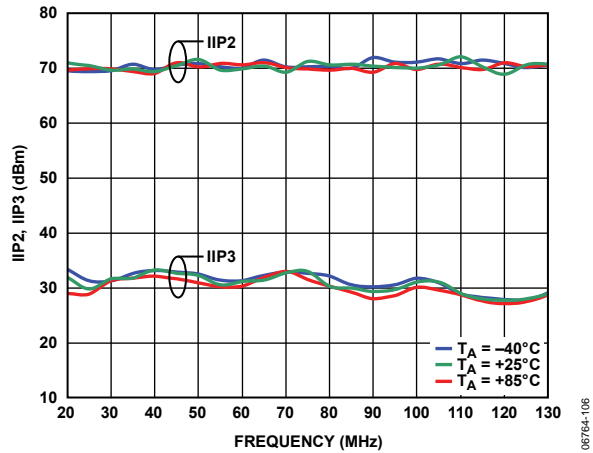

Figure 6. Input Third-Order Intercept (IIP3) and Input Second-Order Intercept Point (IIP2) vs. RF Frequency (Low Frequency Range)

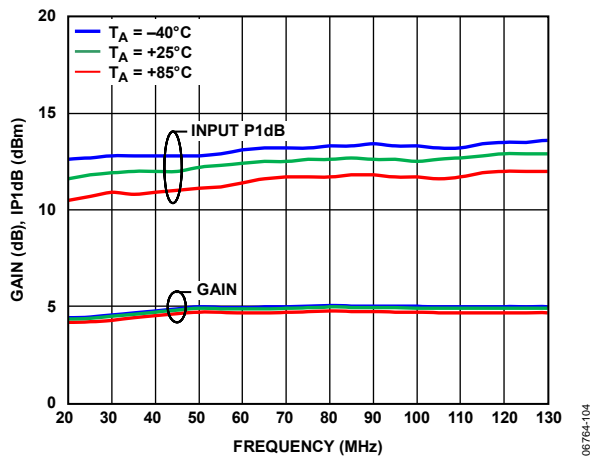

Figure 4. Conversion Gain and Input 1 dB Compression Point (IP1dB) vs. RF Frequency (Low Frequency Range)

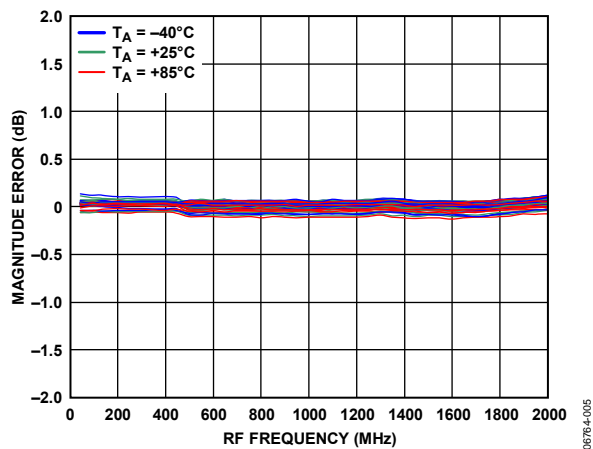

Figure 7. I/Q Gain Mismatch vs. RF Frequency

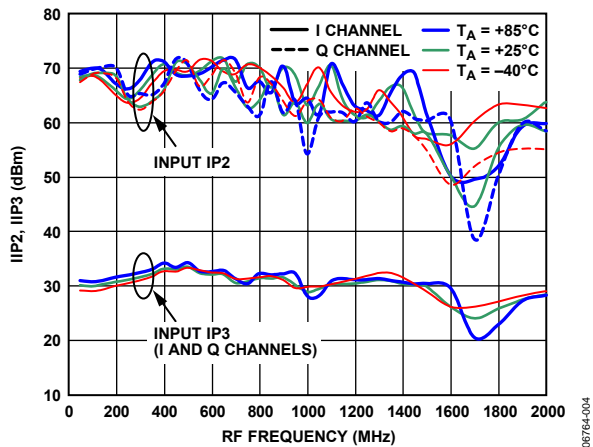

Figure 5. Input Third-Order Intercept (IIP3) and Input Second-Order Intercept Point (IIP2) vs. RF Frequency

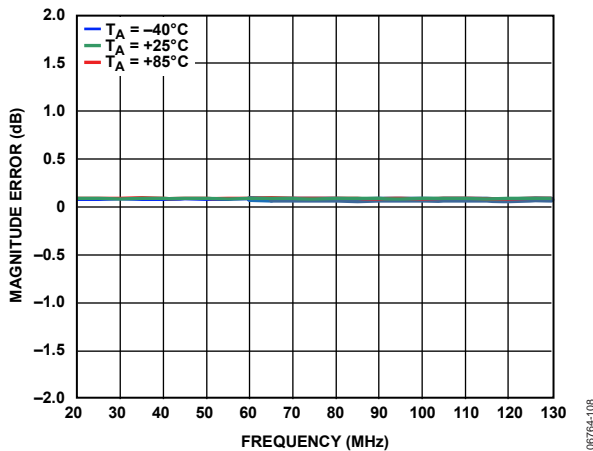

Figure 8. I/Q Gain Mismatch vs. RF Frequency (Low Frequency Range)

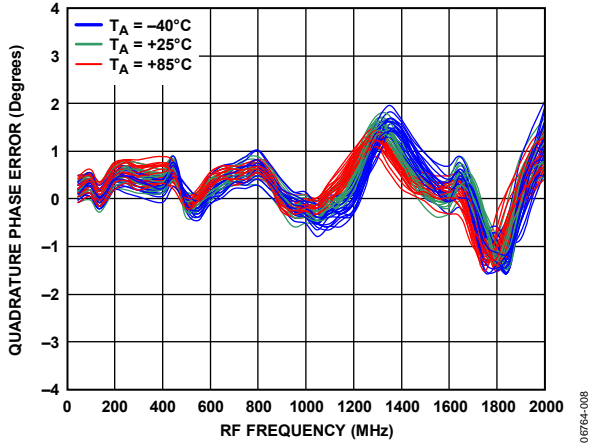

Figure 9. I/Q Quadrature Phase Error vs. RF Frequency

06764-008

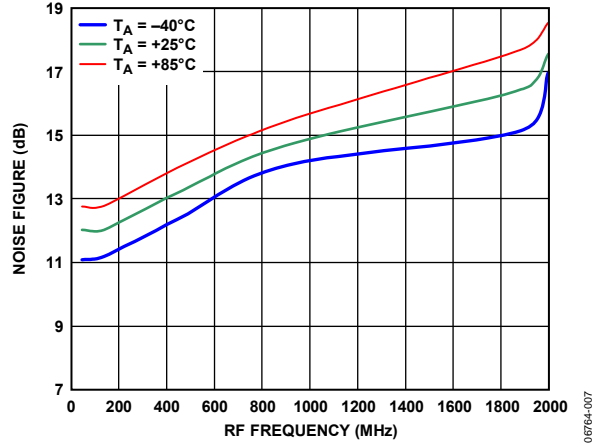

Figure 12. Noise Figure vs. RF Frequency

06764-007

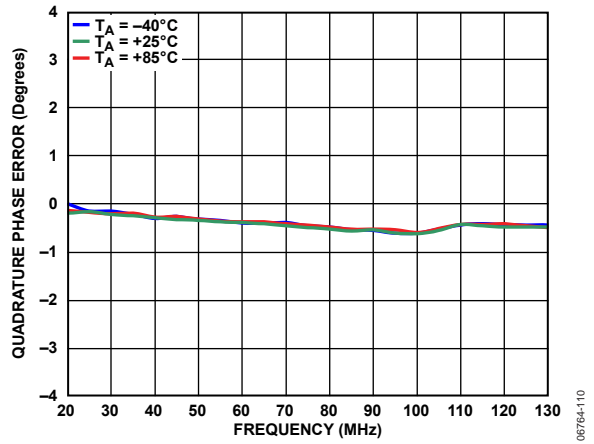

Figure 10. I/Q Quadrature Phase Error vs. RF Frequency (Low Frequency Range)

06764-110

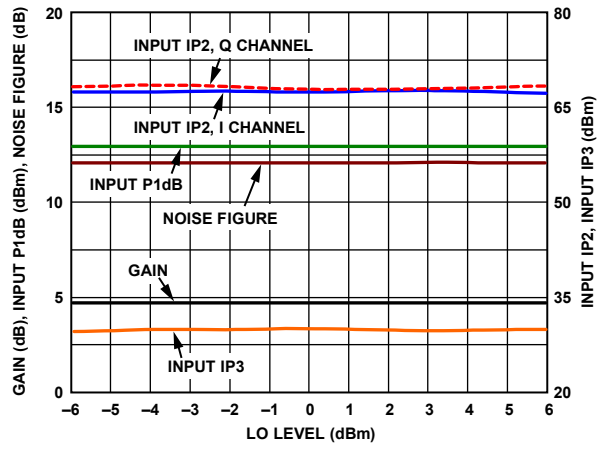

Figure 13. Conversion Gain, Noise Figure, IIP3, IIP2, and IP1dB vs. LO Level,  $f_{RF} = 140$  MHz

06764-009

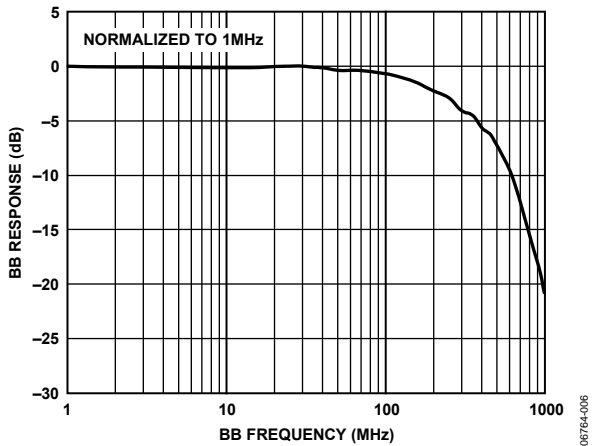

Figure 11. Normalized I/Q Baseband Frequency Response

06764-006

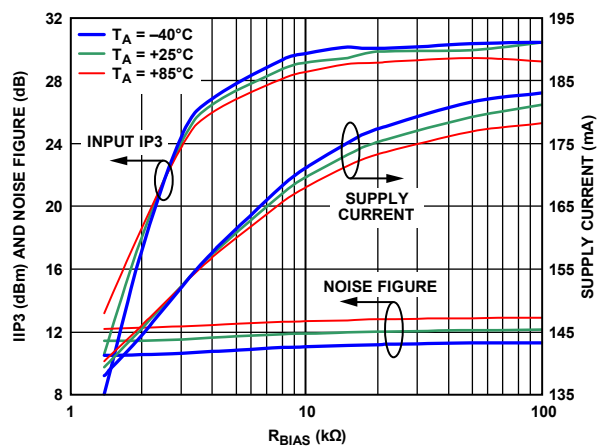

Figure 14. Noise Figure, IIP3, and Supply Current vs.  $R_{BIAS}$ ,  $f_{RF} = 140$  MHz

06764-010

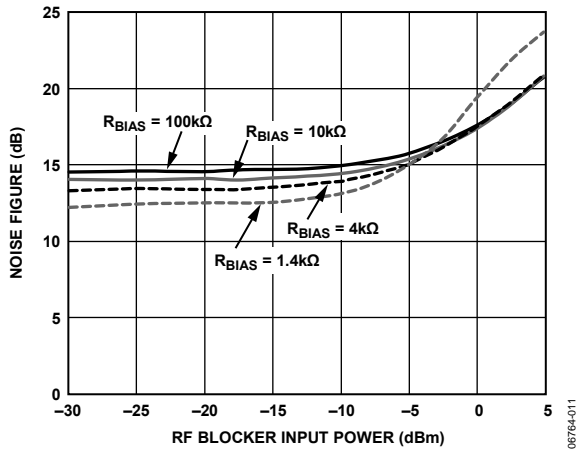

Figure 15. Noise Figure vs. Input Blocker Level,  $f_{RF} = 900$  MHz (RF Blocker 5 MHz Offset)

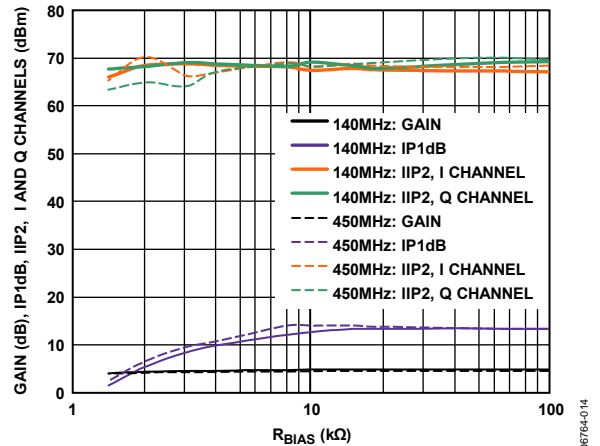

Figure 18. Conversion Gain, IP1dB, IIP2 I Channel, and IIP2 Q Channel vs.  $R_{BIAS}$

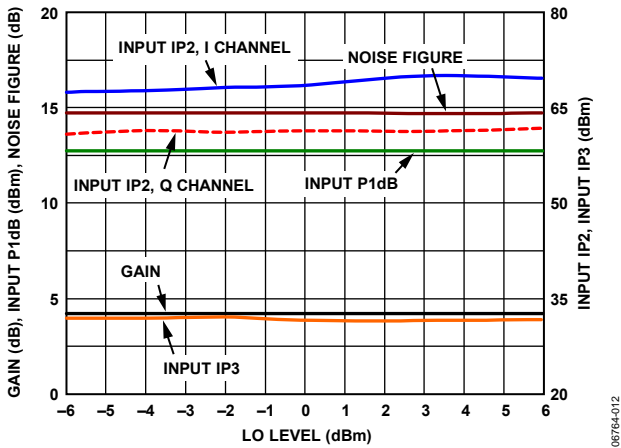

Figure 16. Conversion Gain, Noise Figure, IIP3, IIP2, and IP1dB vs. LO Level,  $f_{RF} = 900$  MHz

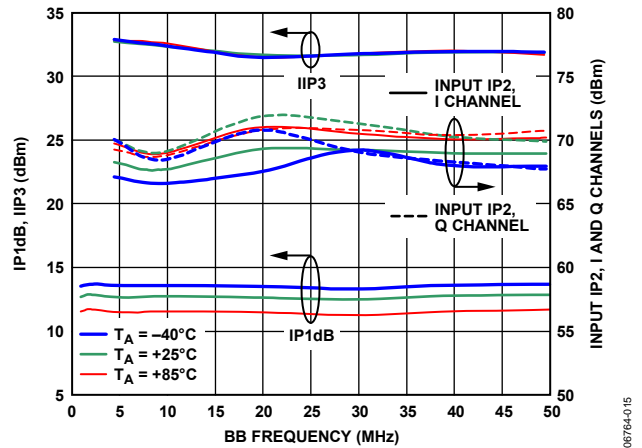

Figure 19. IIP3, IIP2, IP1dB vs. Baseband Frequency

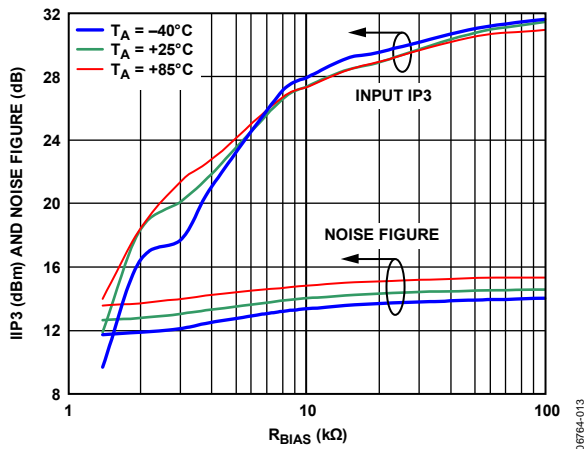

Figure 17. IIP3 and Noise Figure vs.  $R_{BIAS}$ ,  $f_{RF} = 900$  MHz

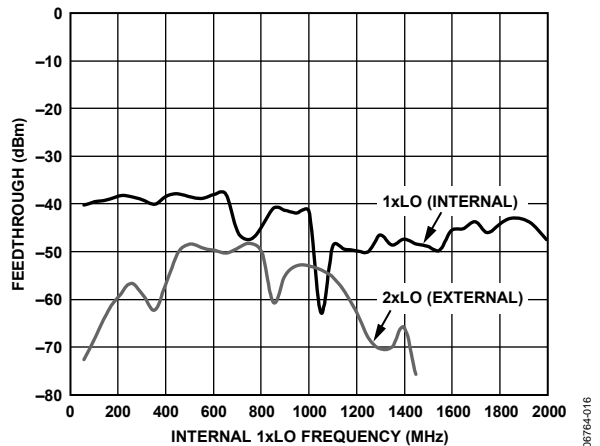

Figure 20. LO-to-BB Feedthrough vs. 1xLO Frequency (Internal LO Frequency)

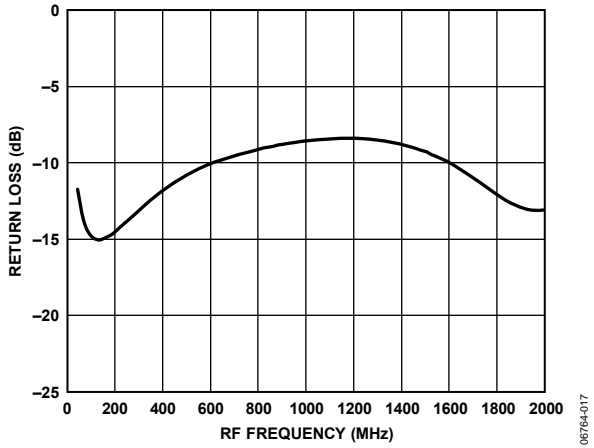

Figure 21. RF Port Return Loss vs. RF Frequency, Measured on Characterization Board through ETC1-1-13 Balun with 120 nH Bias Inductors

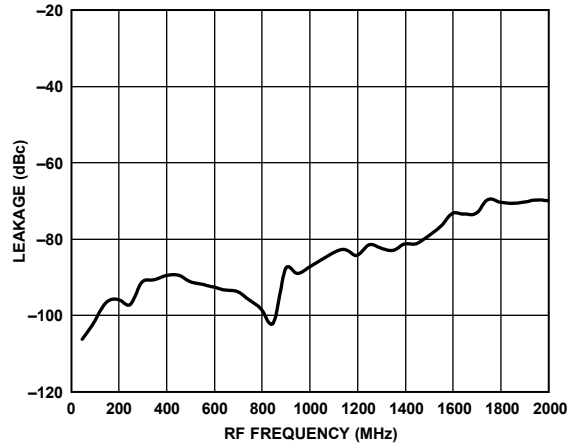

Figure 23. RF-to-LO Leakage vs. RF Frequency

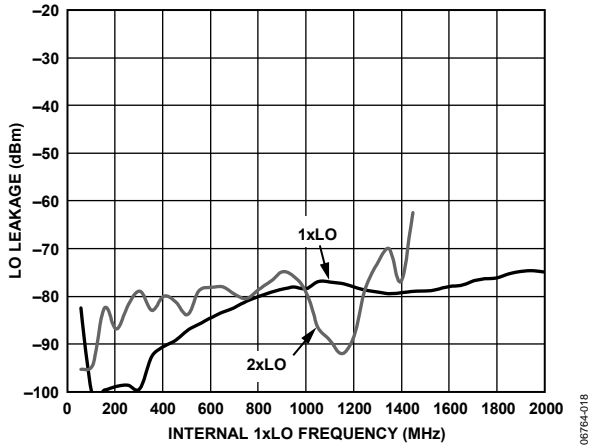

Figure 22. LO-to-RF Leakage vs. Internal 1xLO Frequency

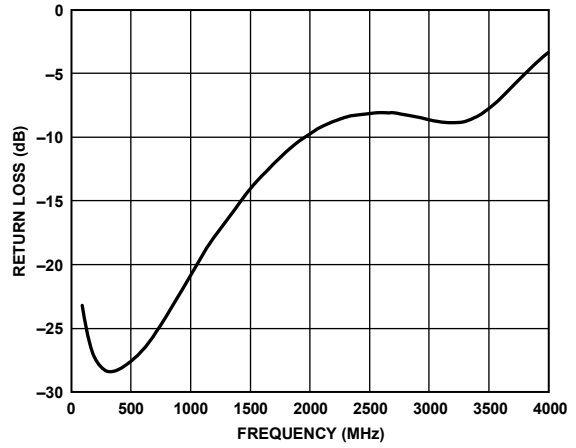

Figure 24. Single-Ended LO Port Return Loss vs. LO Frequency, LOIN AC-Coupled to Ground

DISTRIBUTIONS FOR  $f_{RF} = 140 \text{ MHz}$

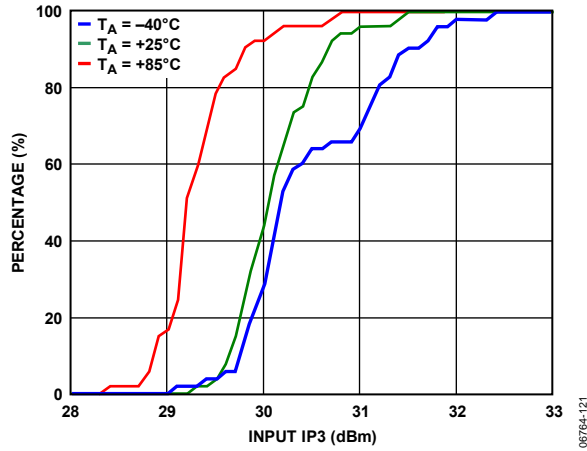

Figure 25. IIP3 Distributions

08764-121

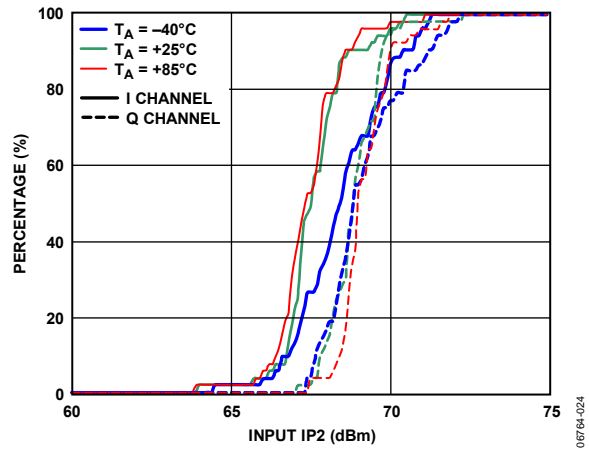

Figure 28. IIP2 Distributions for I Channel and Q Channel

08764-024

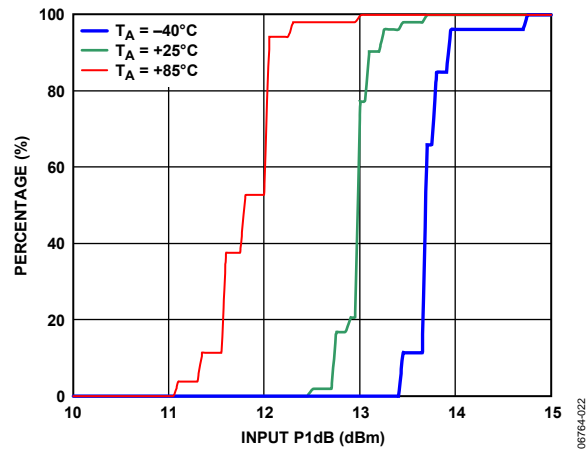

Figure 26. IP1dB Distributions

08764-022

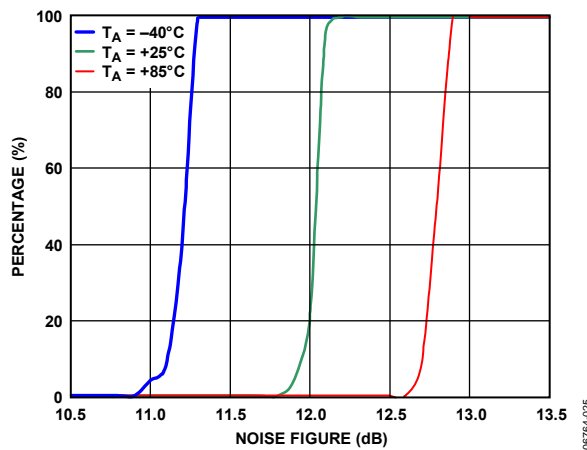

Figure 29. Noise Figure Distributions

08764-025

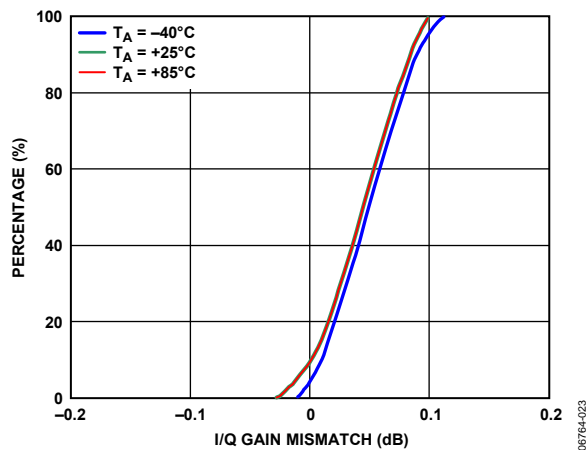

Figure 27. I/Q Gain Mismatch Distributions

08764-023

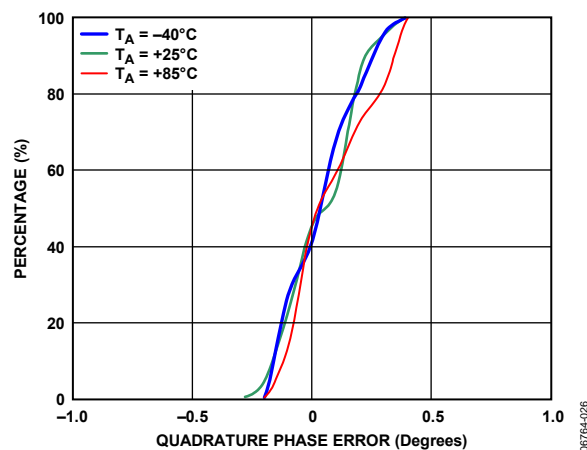

Figure 30. I/Q Quadrature Error Distributions

08764-026

DISTRIBUTIONS FOR  $f_{RF} = 450 \text{ MHz}$

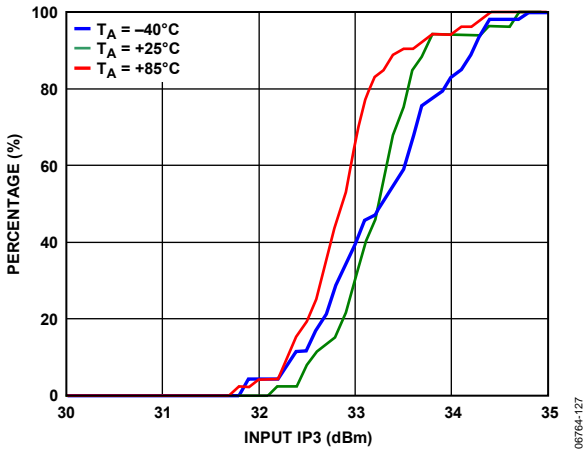

Figure 31. IIP3 Distributions

06764-127

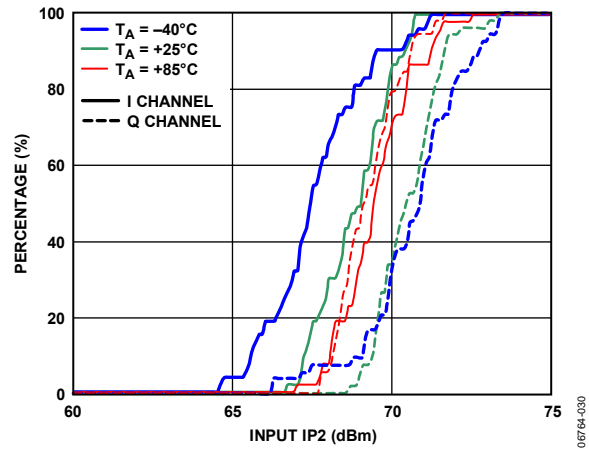

Figure 34. IIP2 Distributions for I Channel and Q Channel

06764-030

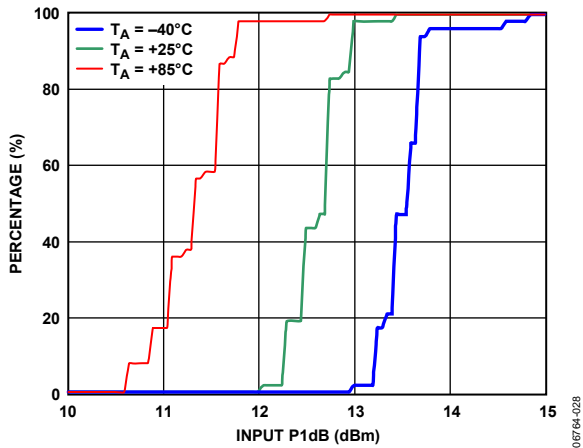

Figure 32. IP1dB Distributions

06764-028

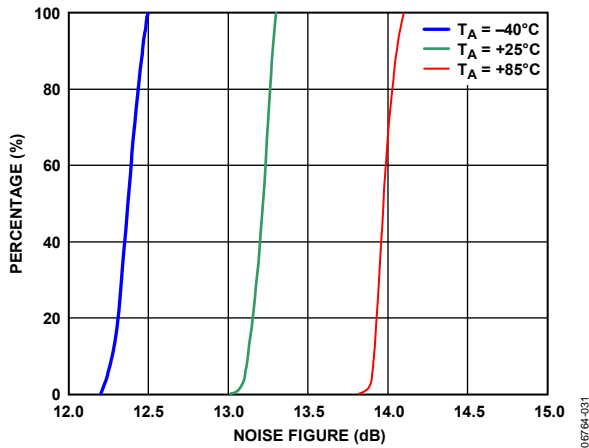

Figure 35. Noise Figure Distributions

06764-031

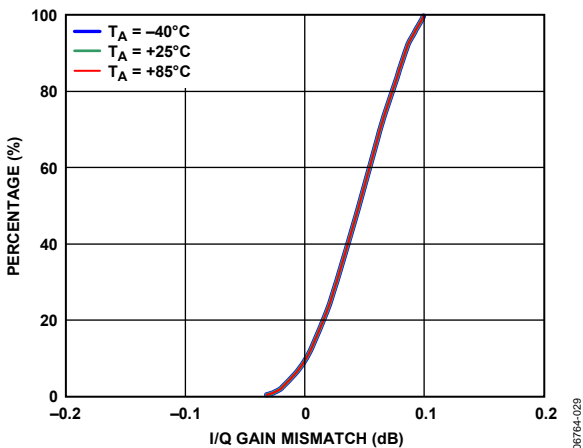

Figure 33. I/Q Gain Mismatch Distributions

06764-029

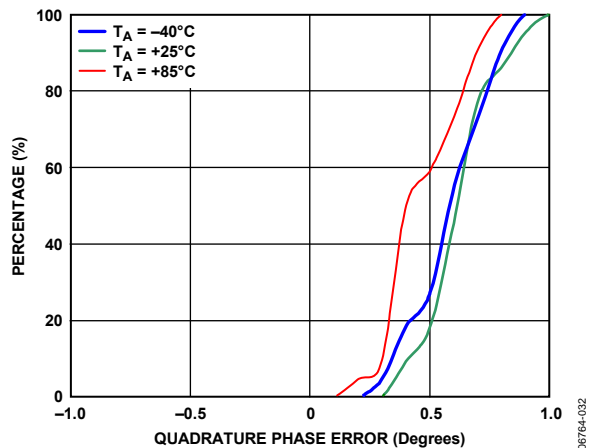

Figure 36. I/Q Quadrature Error Distributions

06764-032

DISTRIBUTIONS FOR  $f_{RF} = 900 \text{ MHz}$

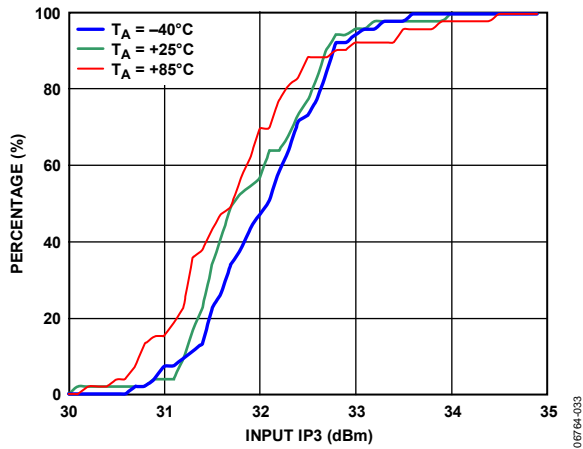

Figure 37. IIP3 Distributions

06764-033

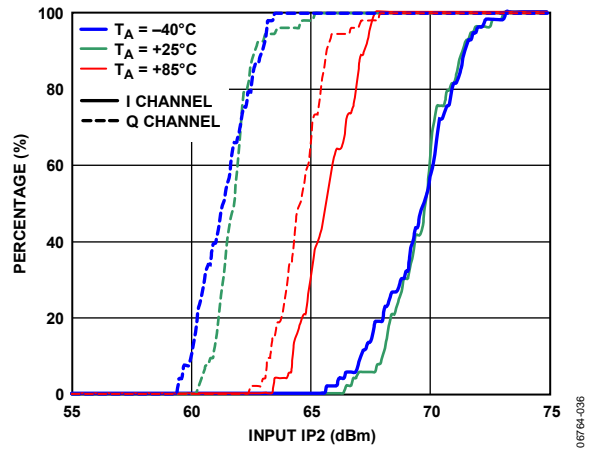

Figure 40. IIP2 Distributions for I Channel and Q Channel

06764-036

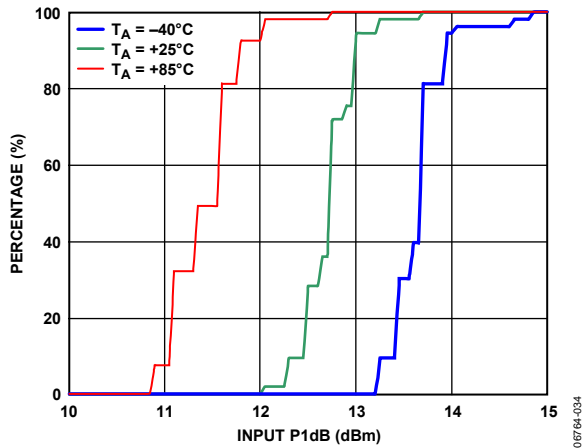

Figure 38. IP1dB Distributions

06764-034

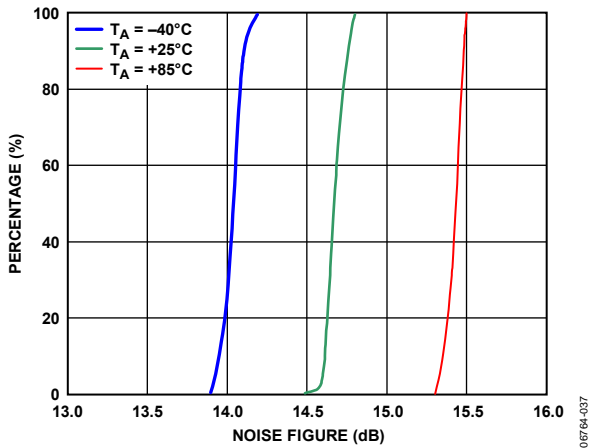

Figure 41. Noise Figure Distributions

06764-037

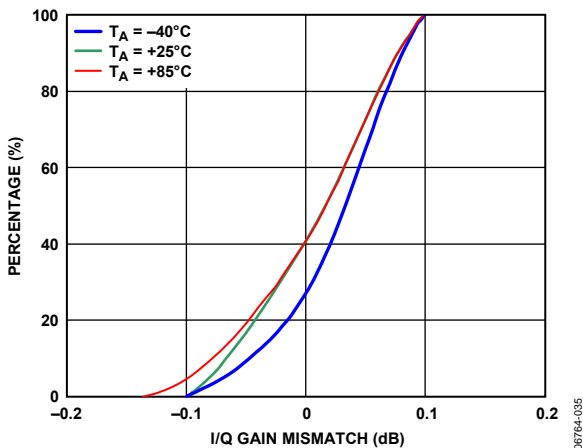

Figure 39. I/Q Gain Mismatch Distributions

06764-035

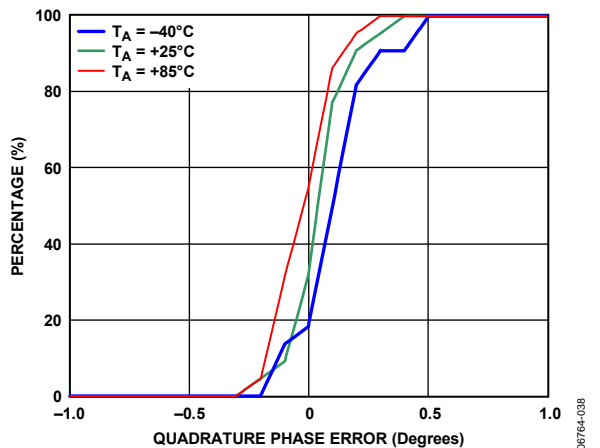

Figure 42. I/Q Quadrature Error Distributions

06764-038

DISTRIBUTIONS FOR  $f_{RF} = 1900 \text{ MHz}$

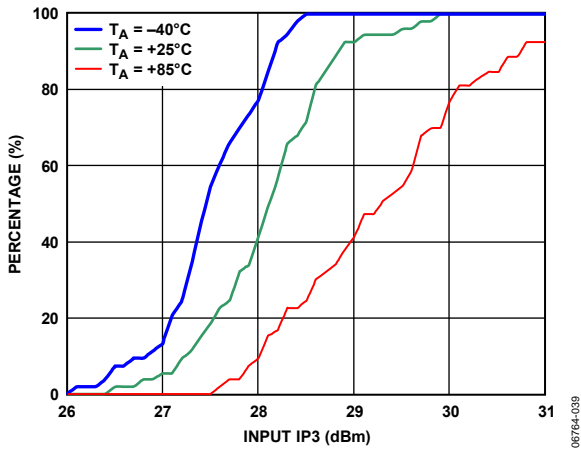

Figure 43. IIP3 Distributions

08764-039

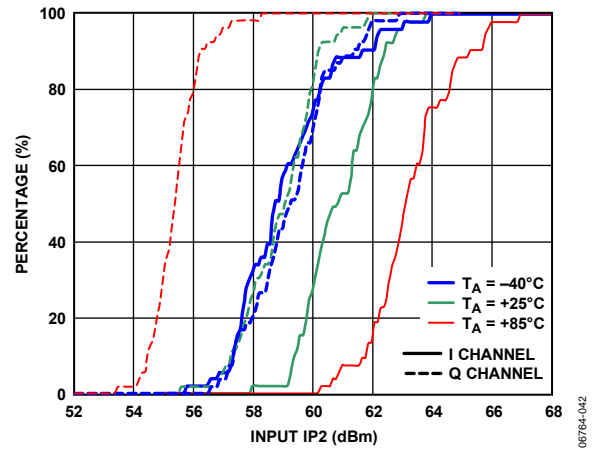

Figure 46. IIP2 Distributions for I Channel and Q Channel

08764-042

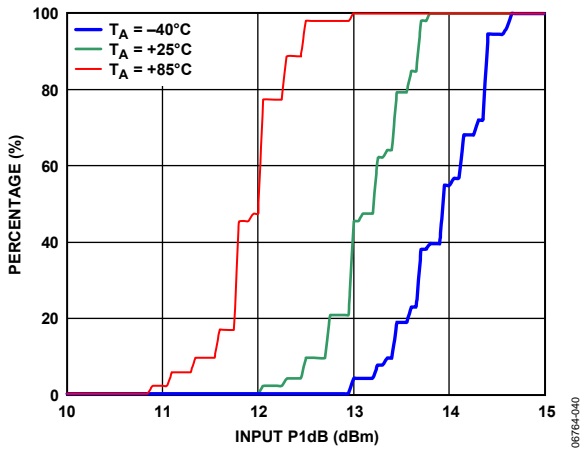

Figure 44. IP1dB Distributions

08764-040

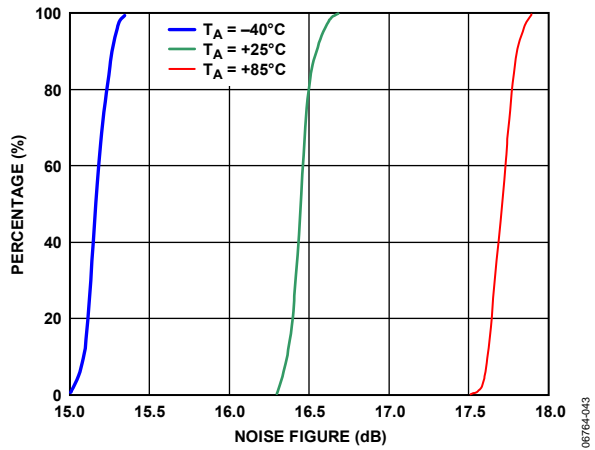

Figure 47. Noise Figure Distributions

08764-043

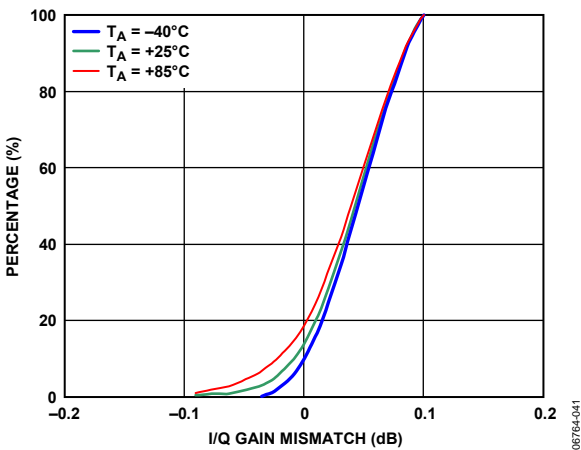

Figure 45. I/Q Gain Mismatch Distributions

08764-041

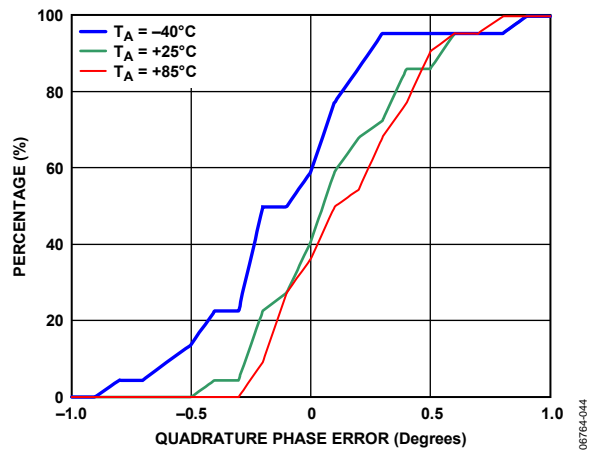

Figure 48. I/Q Quadrature Error Distributions

08764-044

## CIRCUIT DESCRIPTION

The ADL5387 can be divided into five sections: the local oscillator (LO) interface, the RF voltage-to-current (V-to-I) converter, the mixers, the differential emitter follower outputs, and the bias circuit. A detailed block diagram of the device is shown in Figure 49.

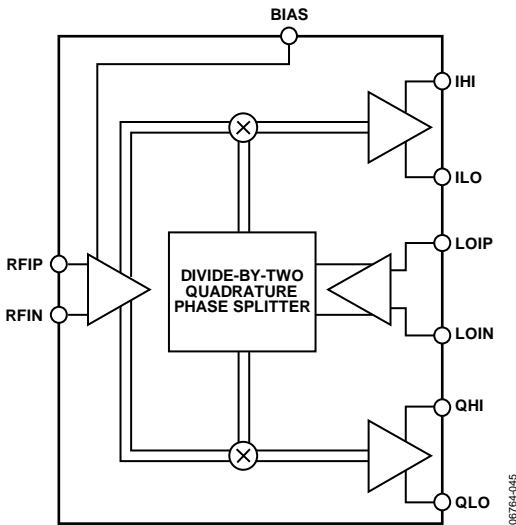

Figure 49. Block Diagram

The LO interface generates two LO signals at  $90^\circ$  of phase difference to drive two mixers in quadrature. RF signals are converted into currents by the V-to-I converters that feed into the two mixers. The differential I and Q outputs of the mixers are buffered via emitter followers. Reference currents to each section are generated by the bias circuit. A detailed description of each section follows.

### LO INTERFACE

The LO interface consists of a buffer amplifier followed by a frequency divider that generate two carriers at half the input frequency and in quadrature with each other. Each carrier is then amplified and amplitude-limited to drive the double-balanced mixers.

### V-TO-I CONVERTER

The differential RF input signal is applied to a resistively degenerated common base stage, which converts the differential input voltage to output currents. The output currents then modulate the two half-frequency LO carriers in the mixer stage.

### MIXERS

The ADL5387 has two double-balanced mixers: one for the in-phase channel (I channel) and one for the quadrature channel (Q channel). These mixers are based on the Gilbert cell design of four cross-connected transistors. The output currents from the two mixers are summed together in the resistive loads that then feed into the subsequent emitter follower buffers.

### EMITTER FOLLOWER BUFFERS

The output emitter followers drive the differential I and Q signals off-chip. The output impedance is set by on-chip  $25\ \Omega$  series resistors that yield a  $50\ \Omega$  differential output impedance for each baseband port. The fixed output impedance forms a voltage divider with the load impedance that reduces the effective gain. For example, a  $500\ \Omega$  differential load has 1 dB lower effective gain than a high ( $10\ \text{k}\Omega$ ) differential load impedance.

### BIAS CIRCUIT

A band gap reference circuit generates the proportional-to-absolute temperature (PTAT) as well as temperature-independent reference currents used by different sections. The mixer current can be reduced via an external resistor between the BIAS pin and ground. When the BIAS pin is open, the mixer runs at maximum current and hence the greatest dynamic range. The mixer current can be reduced by placing a resistance to ground; therefore, reducing overall power consumption, noise figure, and IIP3. The effect on each of these parameters is shown in Figure 14, Figure 17, and Figure 18.

# APPLICATIONS INFORMATION

## BASIC CONNECTIONS

Figure 51 shows the basic connections schematic for the [ADL5387](#).

## POWER SUPPLY

The nominal voltage supply for the [ADL5387](#) is 5 V and is applied to the VPA, VPB, VPL, and VPX pins. Ground should be connected to the COM, CML, and CMRF pins. Each of the supply pins should be decoupled using two capacitors; recommended capacitor values are 100 pF and 0.1  $\mu$ F.

## LOCAL OSCILLATOR (LO) INPUT

The LO port is driven in a single-ended manner. The LO signal must be ac-coupled via a 1000 pF capacitor directly into LOIP, and LOIN is ac-coupled to ground also using a 1000 pF capacitor. The LO port is designed for a broadband 50  $\Omega$  match and therefore exhibits excellent return loss from 60 MHz to 4 GHz. The LO return loss can be seen in Figure 24. Figure 50 shows the LO input configuration.

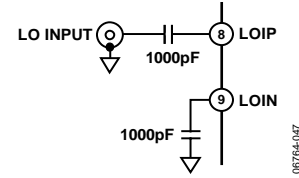

Figure 50. Single-Ended LO Drive

The recommended LO drive level is between  $-6$  dBm and  $+6$  dBm. For operation below 50 MHz, a minimum LO drive level of 0 dBm should be used. The LO frequency at the input to the device should be twice that of the desired LO frequency at the mixer core. The applied LO frequency range is between 60 MHz and 4 GHz.

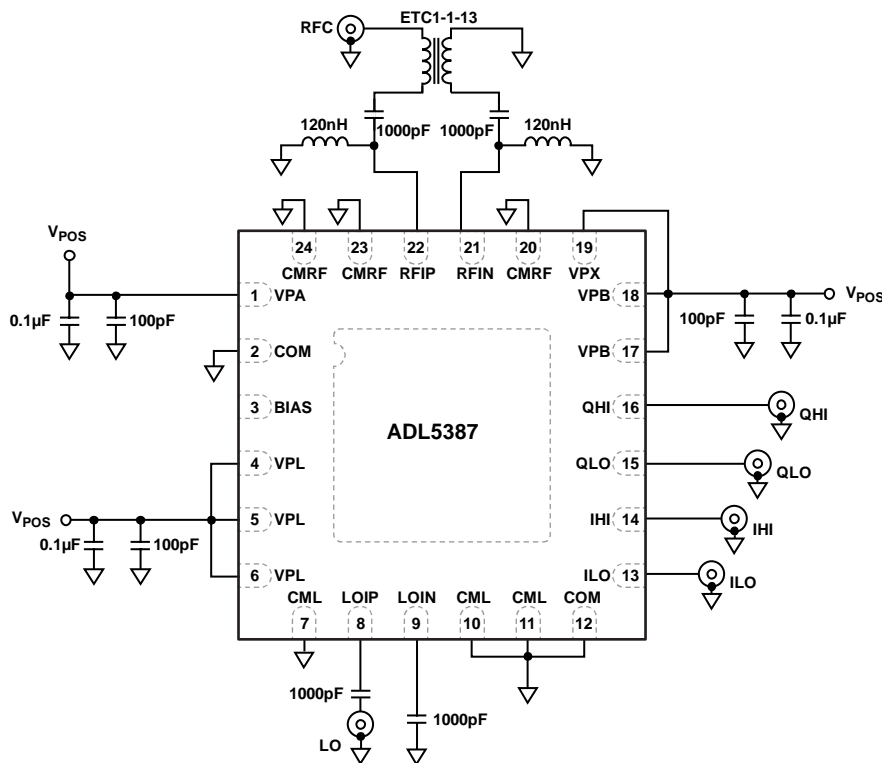

Figure 51. Basic Connections Schematic for [ADL5387](#)

**RF INPUT**

The RF inputs have a differential input impedance of approximately 50 Ω. For optimum performance, the RF port should be driven differentially through a balun. The recommended balun is M/A-COM ETC1-1-13. The RF inputs to the device should be ac-coupled with 1000 pF capacitors. Ground-referenced choke inductors must also be connected to RFIP and RFIN (recommended value = 120 nH, Coilcraft 0402CS-R12XJL) for appropriate biasing. Several important aspects must be taken into account when selecting an appropriate choke inductor for this application. First, the inductor must be able to handle the approximately 40 mA of standing dc current being delivered from each of the RF input pins (RFIP, RFIN). (The suggested 0402 inductor has a 50 mA current rating). The purpose of the choke inductors is to provide a very low resistance dc path to ground and high ac impedance at the RF frequency so as not to affect the RF input impedance. A choke inductor that has a self-resonant frequency greater than the RF input frequency ensures that the choke is still looking inductive and therefore has a more predictable ac impedance ( $j\omega L$ ) at the RF frequency. Figure 52 shows the RF input configuration.

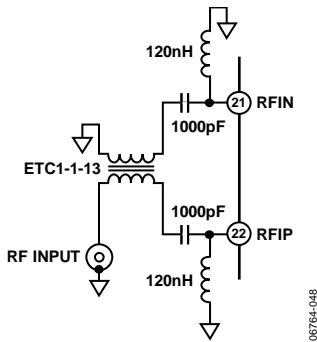

Figure 52. RF Input

The differential RF port return loss has been characterized as shown in Figure 53.

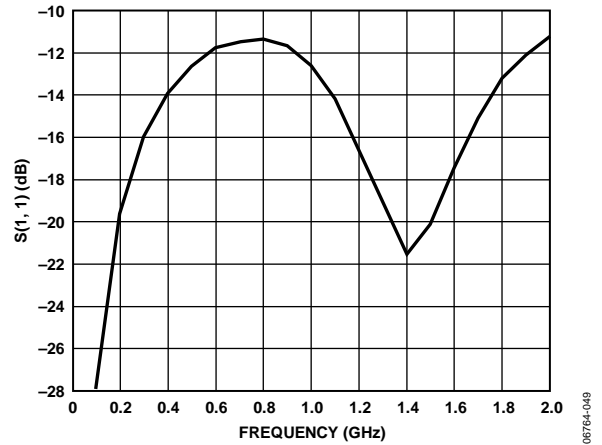

Figure 53. Differential RF Port Return Loss

**BASEBAND OUTPUTS**

The baseband outputs QHI, QLO, IHI, and ILO are fixed impedance ports. Each baseband pair has a 50 Ω differential output impedance. The outputs can be presented with differential loads as low as 200 Ω (with some degradation in linearity and gain) or high impedance differential loads (500 Ω or greater impedance yields the same excellent linearity) that is typical of an ADC. The TCM9-1 9:1 balun converts the differential IF output to single-ended. When loaded with 50 Ω, this balun presents a 450 Ω load to the device. The typical maximum linear voltage swing for these outputs is 2 V p-p differential. The bias level on these pins is equal to  $V_{POS} - 2.8$  V. The output 3 dB bandwidth is 240 MHz. Figure 54 shows the baseband output configuration.

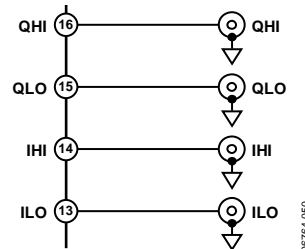

Figure 54. Baseband Output Configuration

**ERROR VECTOR MAGNITUDE (EVM) PERFORMANCE**

EVM is a measure used to quantify the performance of a digital radio transmitter or receiver. A signal received by a receiver would have all constellation points at the ideal locations; however, various imperfections in the implementation (such as carrier leakage, phase noise, and quadrature error) cause the actual constellation points to deviate from the ideal locations.

The ADL5387 shows excellent EVM performance for various modulation schemes. Figure 55 shows typical EVM performance over input power range for a point-to-point application with 16 QAM modulation schemes and zero-IF baseband. The differential dc offsets on the ADL5387 are in the order of a few mV. However, ac coupling the baseband outputs with 10  $\mu$ F capacitors helps to eliminate dc offsets and enhances EVM performance. With a 10 MHz BW signal, 10  $\mu$ F ac coupling capacitors with the 500  $\Omega$  differential load results in a high-pass corner frequency of  $\sim$ 64 Hz which absorbs an insignificant amount of modulated signal energy from the baseband signal. By using ac coupling capacitors at the baseband outputs, the dc offset effects, which can limit dynamic range at low input power levels, can be eliminated.

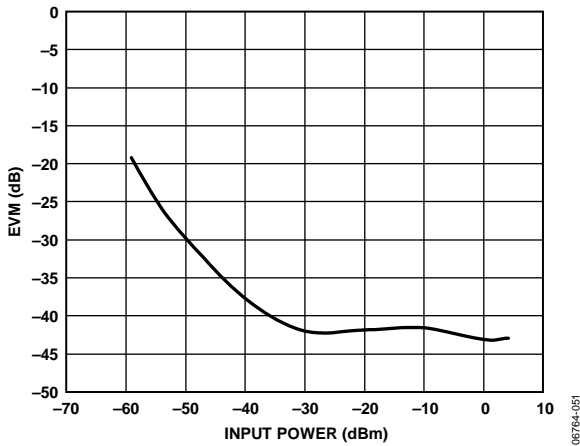

Figure 55. RF = 140 MHz, IF = 0 Hz, EVM vs. Input Power for a 16 QAM 10 Msym/s Signal (AC-Coupled Baseband Outputs)

Figure 56 shows the EVM performance of the ADL5387 when ac-coupled, with an IEEE 802.16e WiMAX signal.

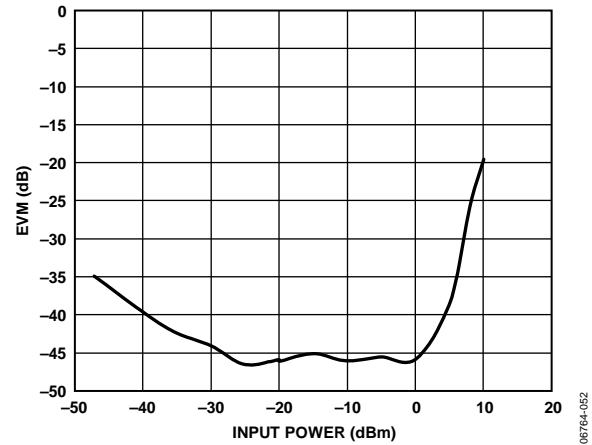

Figure 56. RF = 750 MHz, IF = 0 Hz, EVM vs. Input Power for a 16 QAM 10 MHz Bandwidth Mobile WiMAX Signal (AC-Coupled Baseband Outputs)

Figure 57 exhibits the zero IF EVM performance of a WCDMA signal over a wide RF input power range.

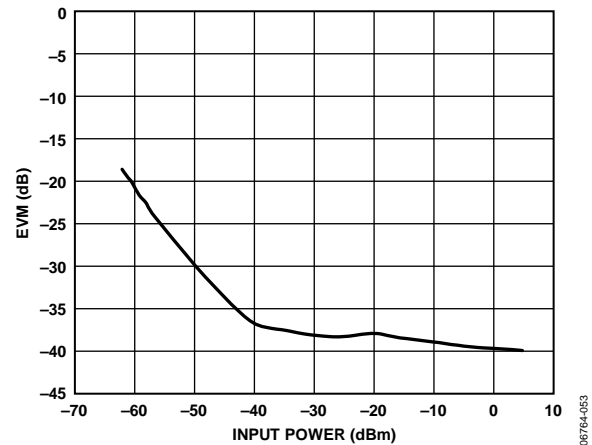

Figure 57. RF = 1950 MHz, IF = 0 Hz, EVM vs. Input Power for a WCDMA (AC-Coupled Baseband Outputs)

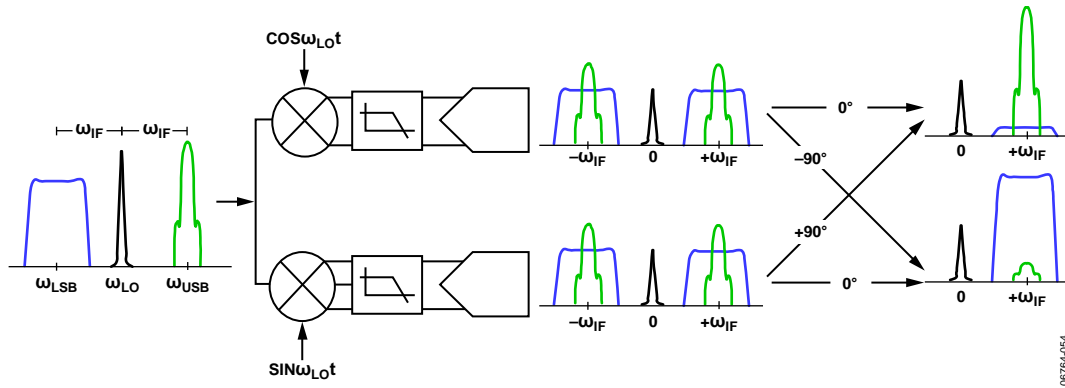

Figure 58. Illustration of the Image Problem

### LOW IF IMAGE REJECTION

The image rejection ratio is the ratio of the intermediate frequency (IF) signal level produced by the desired input frequency to that produced by the image frequency. The image rejection ratio is expressed in decibels. Appropriate image rejection is critical because the image power can be much higher than that of the desired signal, thereby plaguing the down conversion process. Figure 58 illustrates the image problem. If the upper sideband (lower sideband) is the desired band, a 90° shift to the Q channel (I channel) cancels the image at the lower sideband (upper sideband).

Figure 59 shows the excellent image rejection capabilities of the ADL5387 for low IF applications, such as CDMA2000. The ADL5387 exhibits image rejection greater than 45 dB over the broad frequency range for an IF = 1.23 MHz.

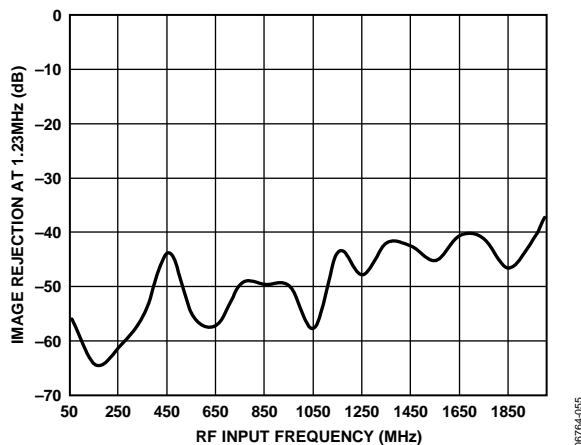

Figure 59. Image Rejection vs. RF Input Frequency for a CDMA2000 Signal, IF = 1.23 MHz

### EXAMPLE BASEBAND INTERFACE

In most direct conversion receiver designs, it is desirable to select a wanted carrier within a specified band. The desired channel can be demodulated by tuning the LO to the appropriate carrier frequency. If the desired RF band contains multiple carriers of interest, the adjacent carriers would also be down converted to a lower IF frequency. These adjacent carriers can be problematic if they are large relative to the wanted carrier as they can overdrive the baseband signal detection circuitry. As a result, it is often necessary to insert a filter to provide sufficient rejection of the adjacent carriers.

It is necessary to consider the overall source and load impedance presented by the ADL5387 and ADC input to design the filter network. The differential baseband output impedance of the ADL5387 is 50 Ω. The ADL5387 is designed to drive a high impedance ADC input. It may be desirable to terminate the ADC input down to lower impedance by using a terminating resistor, such as 500 Ω. The terminating resistor helps to better define the input impedance at the ADC input. The order and type of filter network depends on the desired high frequency rejection required, pass-band ripple, and group delay. Filter design tables provide outlines for various filter types and orders, illustrating the normalized inductor and capacitor values for a 1 Hz cutoff frequency and 1 Ω load. After scaling the normalized prototype element values by the actual desired cut-off frequency and load impedance, the series reactance elements are halved to realize the final balanced filter network component values.

As an example, a second-order, Butterworth, low-pass filter design is shown in Figure 60 where the differential load impedance is 500 Ω, and the source impedance of the ADL5387 is 50 Ω. The normalized series inductor value for the 10-to-1, load-to-source impedance ratio is 0.074 H, and the normalized shunt capacitor is 14.814 F. For a 10.9 MHz cutoff frequency, the single-ended equivalent circuit consists of a 0.54 μH series inductor followed by a 433 pF shunt capacitor.

The balanced configuration is realized as the 0.54 μH inductor is split in half to realize the network shown in Figure 60.

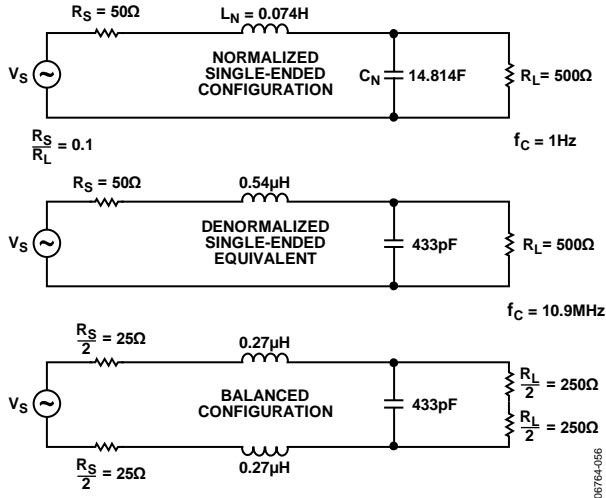

Figure 60. Second-Order, Butterworth, Low-Pass Filter Design Example

A complete design example is shown in Figure 63. A sixth-order Butterworth differential filter having a 1.9 MHz corner frequency interfaces the output of the ADL5387 to that of an ADC input. The 500 Ω load resistor defines the input impedance of the ADC. The filter adheres to typical direct conversion WCDMA applications, where 1.92 MHz away from the carrier IF frequency, 1 dB of rejection is desired and 2.7 MHz away 10 dB of rejection is desired.

Figure 61 and Figure 62 show the measured frequency response and group delay of the filter.

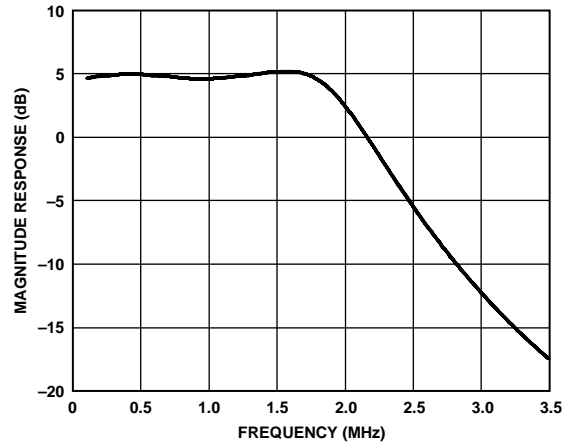

Figure 61. Baseband Filter Response

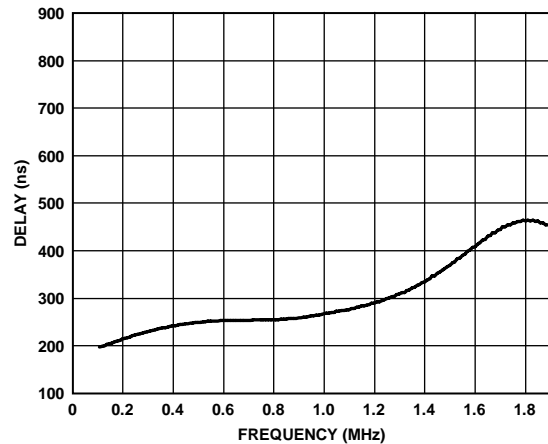

Figure 62. Baseband Filter Group Delay



## CHARACTERIZATION SETUPS

Figure 64 to Figure 66 show the general characterization bench setups used extensively for the ADL5387. The setup shown in Figure 66 was used to do the bulk of the testing and used sinusoidal signals on both the LO and RF inputs. An automated Agilent-VEE program was used to control the equipment over the IEEE bus. This setup was used to measure gain, IP1dB, IIP2, IIP3, I/Q gain match, and quadrature error. The ADL5387 characterization board had a 9-to-1 impedance transformer on each of the differential baseband ports to do the differential-to-single-ended conversion.

The two setups shown in Figure 64 and Figure 65 were used for making NF measurements. Figure 64 shows the setup for measuring NF with no blocker signal applied while Figure 65 was used to measure NF in the presence of a blocker. For both setups, the noise was measured at a baseband frequency of

10 MHz. For the case where a blocker was applied, the output blocker was at 15 MHz baseband frequency. Note that great care must be taken when measuring NF in the presence of a blocker. The RF blocker generator must be filtered to prevent its noise (which increases with increasing generator output power) from swamping the noise contribution of the ADL5387. At least 30 dB of attenuation at the RF and image frequencies is desired. For example, with a 2xLO of 1848 MHz applied to the ADL5387, the internal 1xLO is 924 MHz. To obtain a 15 MHz output blocker signal, the RF blocker generator is set to 939 MHz and the filters tuned such that there is at least 30 dB of attenuation from the generator at both the desired RF frequency (934 MHz) and the image RF frequency (914 MHz). Finally, the blocker must be removed from the output (by the 10 MHz low-pass filter) to prevent the blocker from swamping the analyzer.

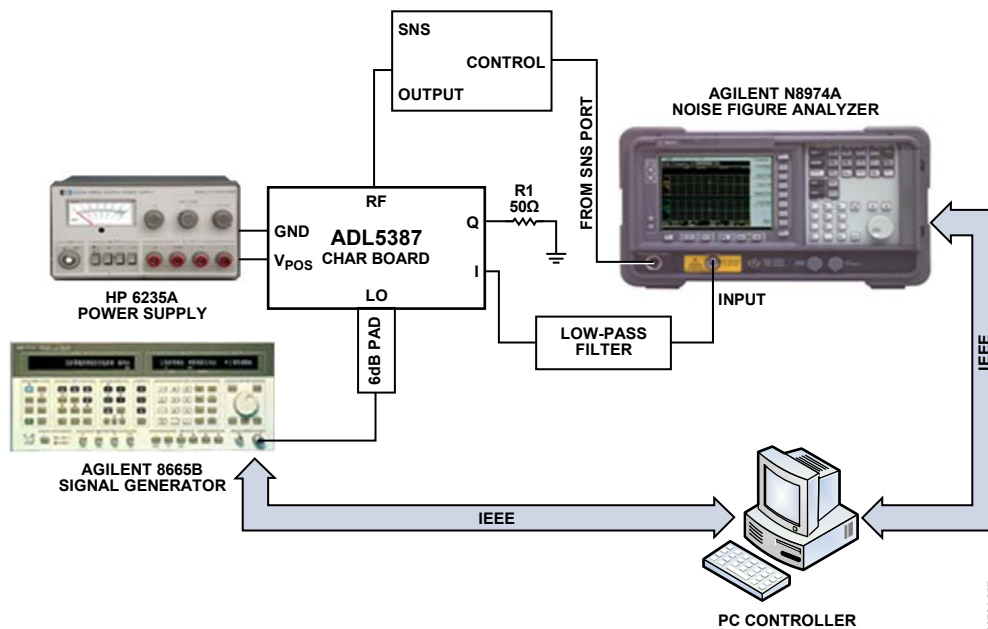

Figure 64. General Noise Figure Measurement Setup

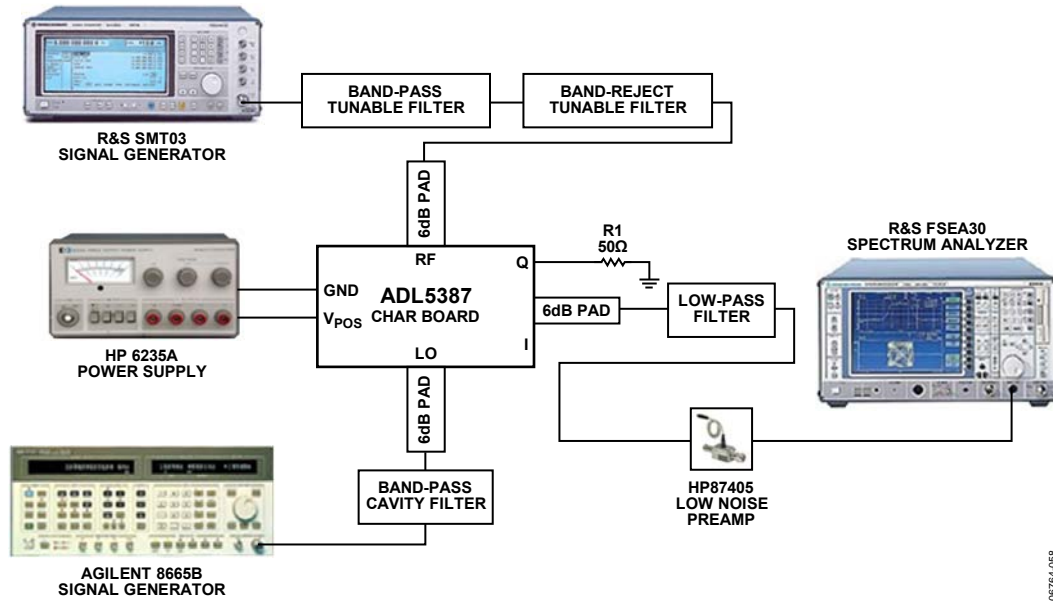

Figure 65. Measurement Setup for Noise Figure in the Presence of a Blocker

06764-058

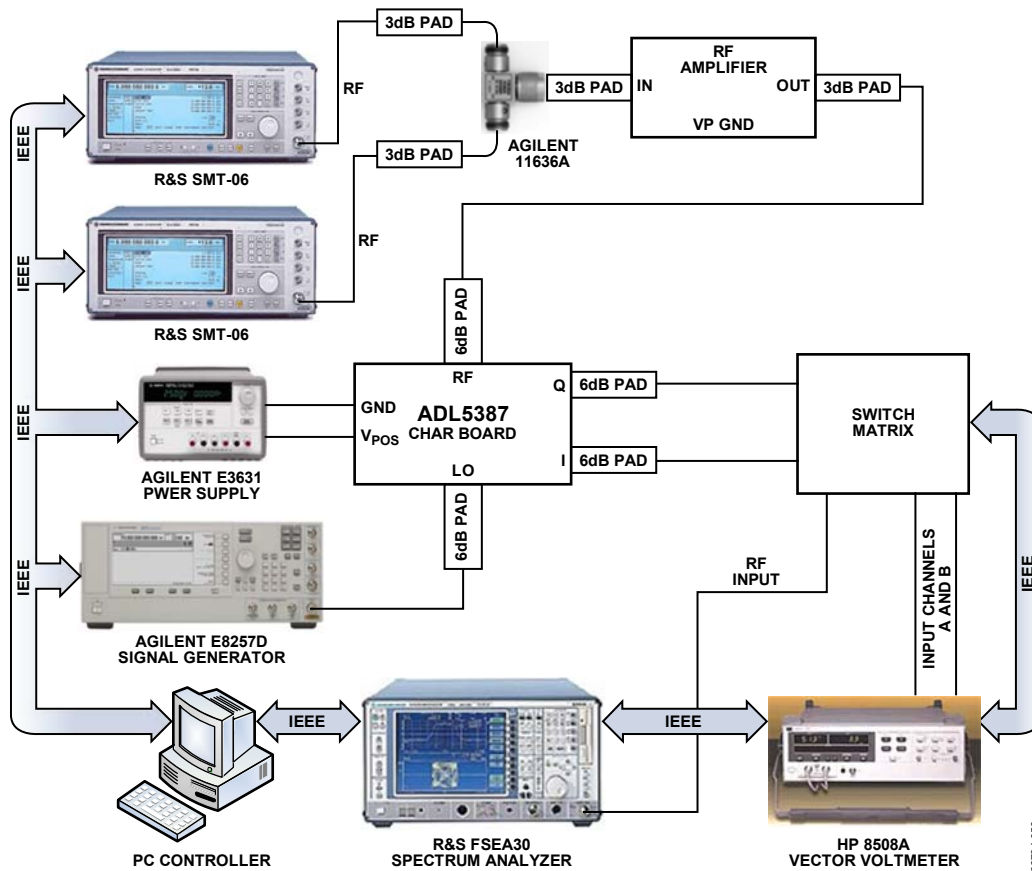

Figure 66. General ADL5387 Characterization Setup

06764-059

### EVALUATION BOARD

The ADL5387 evaluation board is available. The board can be used for single-ended or differential baseband analysis. The default configuration of the board is for single-ended baseband analysis.

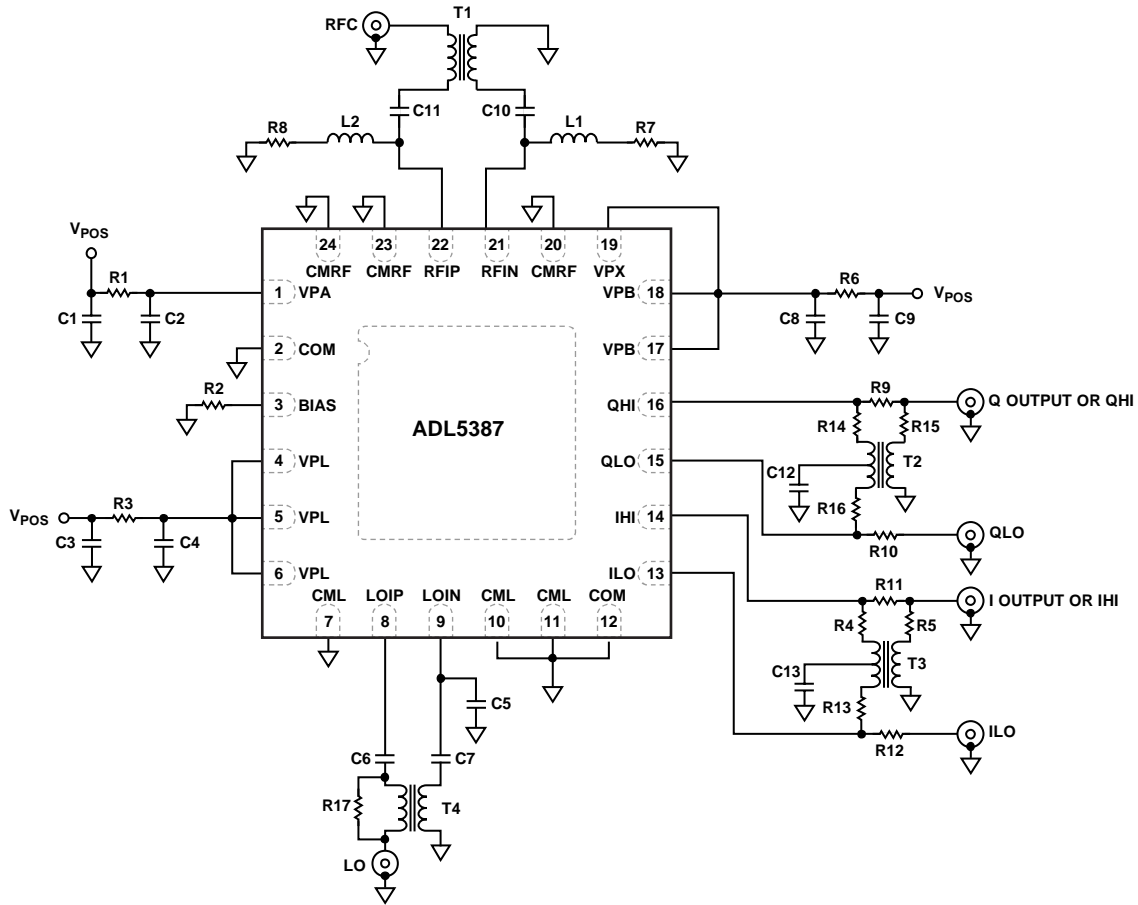
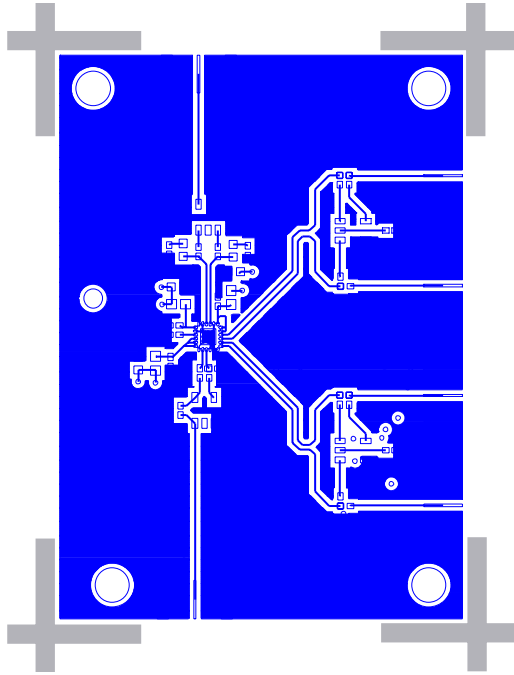

Figure 67. Evaluation Board Schematic

06764-060

Table 4. Evaluation Board Configuration Options

| Component              | Function   | Default Condition   |
|------------------------|--|---|
| VPOS, GND              | Power Supply and Ground Vector Pins.   | Not Applicable  |
| R1, R3, R6             | Power Supply Decoupling. Shorts or power supply decoupling resistors.  | R1, R3, R6 = 0 $\Omega$ (0805)                                |
| C1, C2, C3, C4, C8, C9 | The capacitors provide the required dc coupling up to 2 GHz.   | C2, C4, C8 = 100 pF (0402)<br>C1, C3, C9 = 0.1 $\mu$ F (0603) |
| C5, C6, C7, C10, C11   | AC Coupling Capacitors. These capacitors provide the required ac coupling from 50 MHz to 2 GHz. For operation down to 30 MHz, C10 and C11 should be changed to 0.01 $\mu$ F.   | C5, C6, C10, C11 = 1000 pF (0402),<br>C7 = Open               |
| R4, R5, R9 to R16      | Single-Ended Baseband Output Path. This is the default configuration of the evaluation board. R14 to R16 and R4, R5, and R13 are populated for appropriate balun interface. R9, R10 and R11, R12 are not populated. Baseband outputs are taken from QHI and IHI.<br><br>The user can reconfigure the board to use full differential baseband outputs. R9 to R12 provide a means to bypass the 9:1 TCM9-1 transformer to allow for differential baseband outputs. Access the differential baseband signals by populating R9 to R12 with 0 $\Omega$ and not populating R4, R5, R13 to R16. This way the transformer does not need to be removed. The baseband outputs are taken from the SMAs of Q_HI, Q_LO, I_HI, and I_LO. | R4, R5, R13 to R16 = 0 $\Omega$ (0402),<br>R9 to R12 = Open   |
| L1, L2, R7, R8         | Input Biasing. Inductance and resistance sets the input biasing of the common base input stage. Default value is 120 nH for operation above 50 MHz. For operation down to 30 MHz, L1 and L2 should be changed to 680 nH.   | L1, L2 = 120 nH (0402)<br>R7, R8 = 0 $\Omega$ (0402)          |
| T2, T3                 | IF Output Interface. TCM9-1 converts a differential high impedance IF output to a single-ended output. When loaded with 50 $\Omega$ , this balun presents a 450 $\Omega$ load to the device. The center tap can be decoupled through a capacitor to ground.  | T2, T3 = TCM9-1, 9:1 (Mini-Circuits)                          |
| C12, C13               | Decoupling Capacitors. C12 and C13 are the decoupling capacitors used to reject noise on the center tap of the TCM9-1.   | C12, C13 = 0.1 $\mu$ F (0402)                                 |
| R17                    | LO Input Interface. The LO is driven as a single-ended signal. Although, there is no performance change for a differential signal drive, the option is available by placing a transformer (T4, ETC1-1-13) on the LO input path.  | R17 = 0 $\Omega$ (0402)                                       |
| T1                     | RF Input Interface. ETC1-1-13 is a 1:1 RF balun that converts the single-ended RF input to differential signal.  | T1 = ETC1-1-13, 1:1 (M/A COM)                                 |
| R2                     | R <sub>BIAS</sub> . Optional bias setting resistor. See the Bias Circuit section to see how to use this feature.   | R2 = Open   |



06764-164

Figure 68. Evaluation Board Top Layer

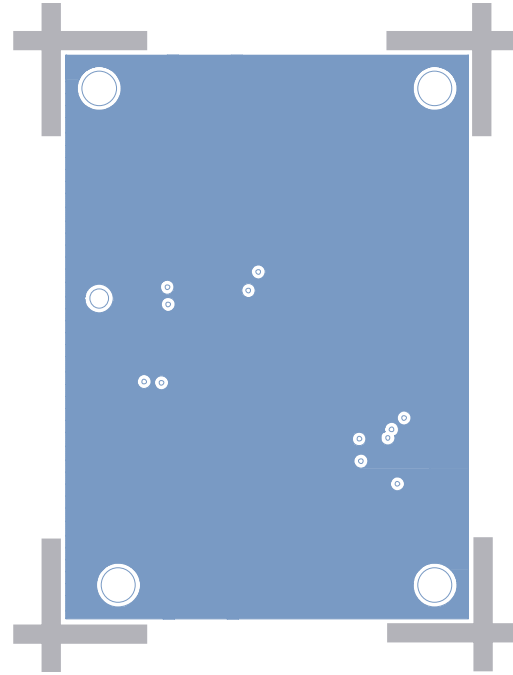

06764-166

Figure 70. Evaluation Board Bottom Layer

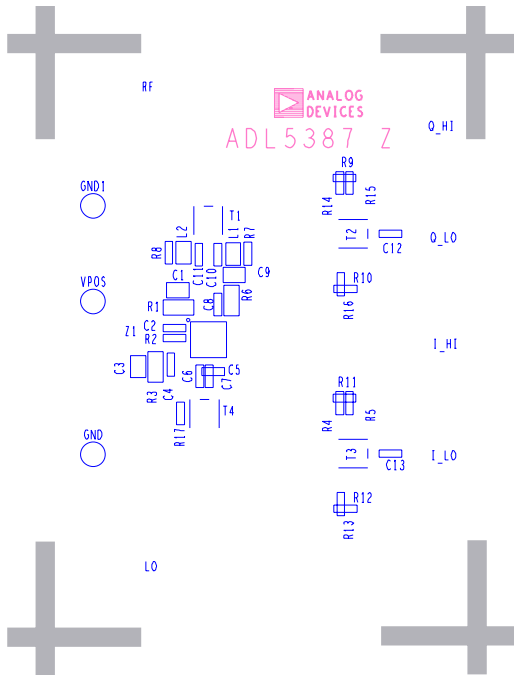

06764-165

Figure 69. Evaluation Board Top Layer Silkscreen

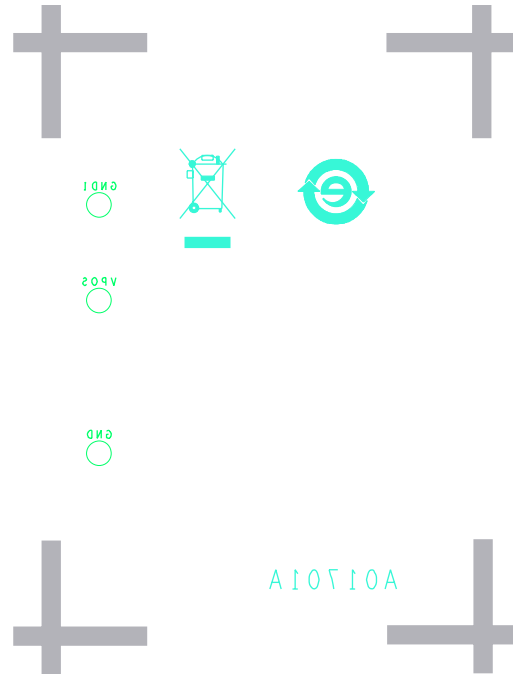

06764-167

Figure 71. Evaluation Board Bottom Layer Silkscreen

OUTLINE DIMENSIONS

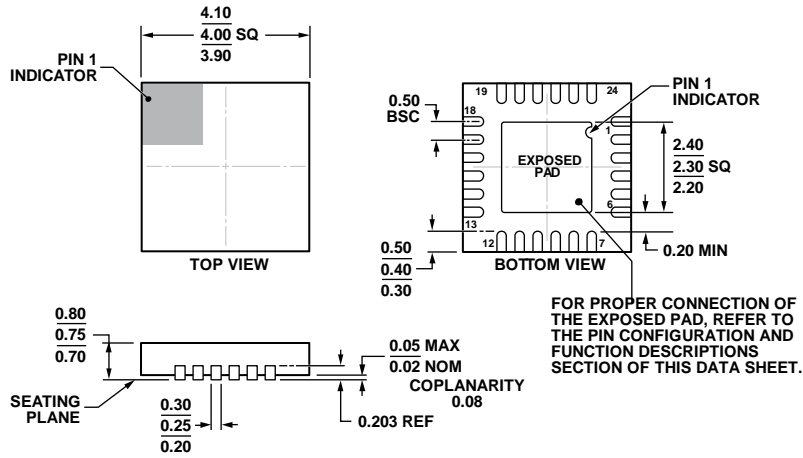

COMPLIANT TO JEDEC STANDARDS MO-220-WGGD-8.

Figure 72. 24-Lead Lead Frame Chip Scale Package [LFCSP]  
 4 mm × 4 mm Body and 0.75 mm Package Height  
 (CP-24-14)  
 Dimensions shown in millimeters

01-18-2012-A

ORDERING GUIDE

| Model <sup>1</sup> | Temperature Range | Package Description             | Package Option | Ordering Quantity |
|--------------------|-------------------|---------------------------------|----------------|-------------------|
| ADL5387ACPZ-R2     | -40°C to +85°C    | 24-Lead LFCSP                   | CP-24-14       | 250               |
| ADL5387ACPZ-R7     | -40°C to +85°C    | 24-Lead LFCSP, 7" Tape and Reel | CP-24-14       | 1,500             |
| ADL5387ACPZ-WP     | -40°C to +85°C    | 24-Lead LFCSP, Waffle Pack      | CP-24-14       | 64                |
| ADL5387-EVALZ      |                   | Evaluation Board                |                |                   |

<sup>1</sup>Z = RoHS Compliant Part.

## Looking for pricing, stock, or lifecycle information?

Click below to explore more details on WIN SOURCE:

 [View ADL5387ACPZ-R7 on WIN SOURCE](#)

 [Analog Devices Inc. Information](#)

## Optimize Your Supply Chain with WIN SOURCE Solutions

-  Global Sourcing Solution
-  Obsolete Management
-  Cost Control Management
-  Shortage Management
-  Alternative Solution
-  Excess Inventory Management