



**THE DATASHEET OF
ADC14DC080CISQE/NOPB**



ADC14DC080 Dual 14-Bit, 80 MSPS A/D Converter with CMOS Outputs

Check for Samples: [ADC14DC080](#)

FEATURES

- Internal Sample-and-Hold Circuit and Precision Reference
- Low Power Consumption
- Clock Duty Cycle Stabilizer
- Single +3.0V Supply Operation
- Power-Down Mode
- Offset Binary or 2's Complement Output Data Format
- 60-Pin WQFN Package, (9x9x0.8mm, 0.5mm Pin-Pitch)

APPLICATIONS

- High IF Sampling Receivers
- Wireless Base Station Receivers
- Test and Measurement Equipment
- Communications Instrumentation
- Portable Instrumentation

KEY SPECIFICATIONS

- Resolution 14 Bits
- Conversion Rate 80 MSPS
- SNR ($f_{IN} = 170$ MHz) 71 dBFS (typ)
- SFDR ($f_{IN} = 170$ MHz) 83 dBFS (typ)
- Full Power Bandwidth 1 GHz (typ)
- Power Consumption 600 mW (typ)

Block Diagram

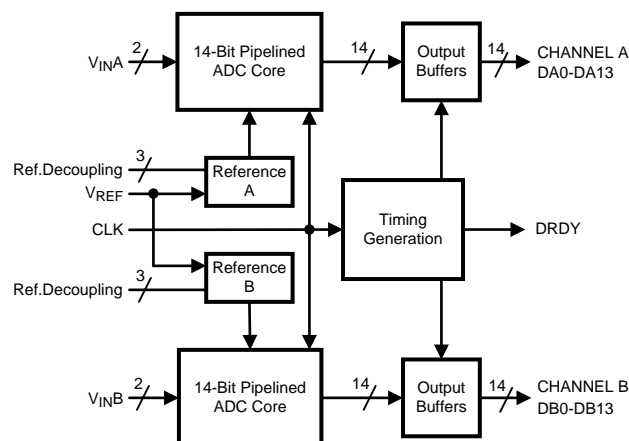

DESCRIPTION

The ADC14DC080 is a high-performance CMOS analog-to-digital converter capable of converting two analog input signals into 14-bit digital words at rates up to 80 Mega Samples Per Second (MSPS). These converters use a differential, pipelined architecture with digital error correction and an on-chip sample-and-hold circuit to minimize power consumption and the external component count, while providing excellent dynamic performance. A unique sample-and-hold stage yields a full-power bandwidth of 1 GHz. The ADC14DC080 may be operated from a single +3.0V power supply. A power-down feature reduces the power consumption to very low levels while still allowing fast wake-up time to full operation. The differential inputs provide a 2V full scale differential input swing. A stable 1.2V internal voltage reference is provided, or the ADC14DC080 can be operated with an external 1.2V reference. Output data format (offset binary versus 2's complement) and duty cycle stabilizer are pin-selectable. The duty cycle stabilizer maintains performance over a wide range of clock duty cycles.

The ADC14DC080 is available in a 60-lead WQFN package and operates over the industrial temperature range of -40°C to $+85^{\circ}\text{C}$.



Please be aware that an important notice concerning availability, standard warranty, and use in critical applications of Texas Instruments semiconductor products and disclaimers thereto appears at the end of this data sheet.

All trademarks are the property of their respective owners.

Connection Diagram

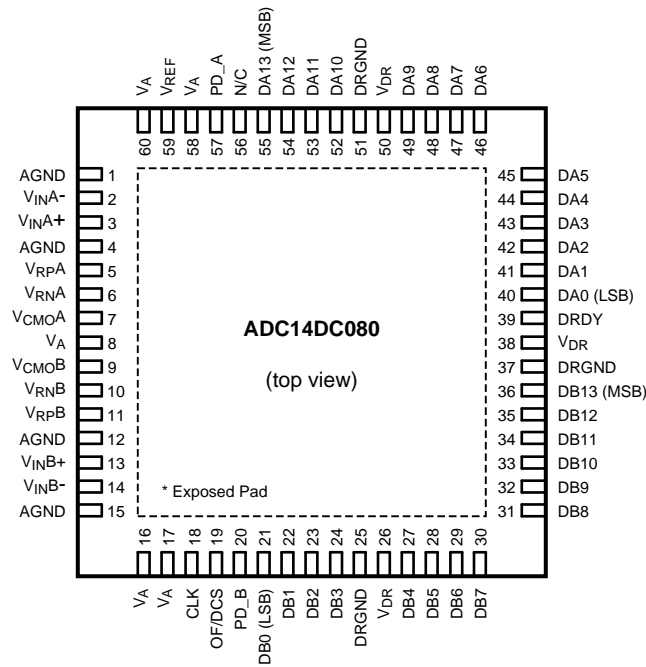

Pin Descriptions and Equivalent Circuits

Pin No.	Symbol	Equivalent Circuit	Description
ANALOG I/O			
3 13	$V_{IN A+}$ $V_{IN B+}$		Differential analog input pins. The differential full-scale input signal level is $2V_{P-P}$ with each input pin signal centered on a common mode voltage, V_{CM} .
2 14	$V_{IN A-}$ $V_{IN B-}$		
5 11	V_{RPA} V_{RPB}		These pins should each be bypassed to AGND with a low ESL (equivalent series inductance) $1\ \mu F$ capacitor placed very close to the pin to minimize stray inductance. An 0201 size $0.1\ \mu F$ capacitor should be placed between V_{RP} and V_{RN} as close to the pins as possible, and a $1\ \mu F$ capacitor should be placed in parallel. V_{RP} and V_{RN} should not be loaded. V_{CMO} may be loaded to 1mA for use as a temperature stable 1.5V reference. It is recommended to use V_{CMO} to provide the common mode voltage, V_{CM} for the differential analog inputs.
7 9	V_{CMOA} V_{CMOB}		
6 10	V_{RNA} $V_{RN B}$		

Pin Descriptions and Equivalent Circuits (continued)

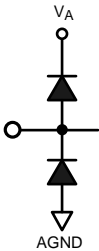
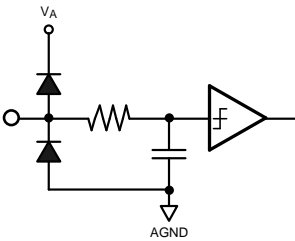
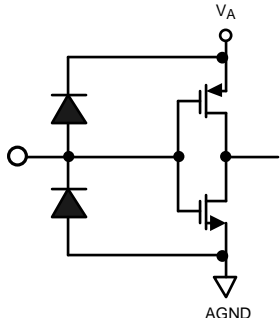
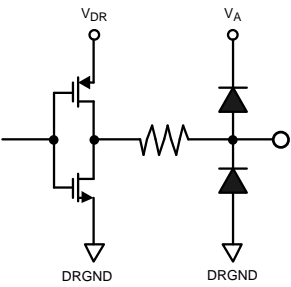
Pin No.	Symbol	Equivalent Circuit	Description
59	V _{REF}		Reference Voltage. This device provides an internally developed 1.2V reference. When using the internal reference, V _{REF} should be decoupled to AGND with a 0.1 μF and a 1μF, low equivalent series inductance (ESL) capacitor. This pin may be driven with an external 1.2V reference voltage. This pin should not be used to source or sink current when the internal reference is used.
DIGITAL I/O			
19	OF/DCS		This is a four-state pin controlling the input clock mode and output data format. OF/DCS = V _A , output data format is 2's complement without duty cycle stabilization applied to the input clock. OF/DCS = AGND, output data format is offset binary, without duty cycle stabilization applied to the input clock. OF/DCS = (2/3)*V _A , output data is 2's complement with duty cycle stabilization applied to the input clock. OF/DCS = (1/3)*V _A , output data is offset binary with duty cycle stabilization applied to the input clock.
18	CLK		The clock input pin. The analog inputs are sampled on the rising edge of the clock input.
57 20	PD_A PD_B		This is a two-state input controlling Power Down. PD = V _A , Power Down is enabled and power dissipation is reduced. PD = AGND, Normal operation.
40-49, 52-55	DA0-DA9, DA10-DA13		Digital data output pins that make up the 14-bit conversion result for Channel A. DA0 (pin 40) is the LSB, while DA13 (pin 55) is the MSB of the output word. Output levels are CMOS compatible.
21-24, 27-36	DB0-DB3, DB4-DB13		Digital data output pins that make up the 14-bit conversion result for Channel B. DB0 (pin 21) is the LSB, while DB13 (pin 36) is the MSB of the output word. Output levels are CMOS compatible.
39	DRDY		Data Ready Strobe. The data output transition is synchronized with the falling edge of this signal. This signal switches at the same frequency as the CLK input.
ANALOG POWER			
8, 16, 17, 58, 60	V _A		Positive analog supply pins. These pins should be connected to a quiet source and be bypassed to AGND with 0.1 μF capacitors located close to the power pins.
1, 4, 12, 15, Exposed Pad	AGND		The ground return for the analog supply. The exposed pad on back of package must be soldered to ground plane to ensure rated performance.

Pin Descriptions and Equivalent Circuits (continued)

Pin No.	Symbol	Equivalent Circuit	Description
DIGITAL POWER			
26, 38, 50	V_{DR}		Positive driver supply pin for the output drivers. This pin should be connected to a quiet voltage source and be bypassed to DRGND with a 0.1 μ F capacitor located close to the power pin.
25, 37, 51	DRGND		The ground return for the digital output driver supply. This pins should be connected to the system digital ground, but not be connected in close proximity to the ADC's AGND pins.



These devices have limited built-in ESD protection. The leads should be shorted together or the device placed in conductive foam during storage or handling to prevent electrostatic damage to the MOS gates.

Absolute Maximum Ratings ⁽¹⁾ ⁽²⁾ ⁽³⁾

Supply Voltage (V_A , V_{DR})		-0.3V to 4.2V
Voltage on Any Pin (Not to exceed 4.2V)		-0.3V to (V_A +0.3V)
Input Current at Any Pin other than Supply Pins ⁽⁴⁾		± 5 mA
Package Input Current ⁽⁴⁾		± 50 mA
Max Junction Temp (T_J)		+150°C
Thermal Resistance (θ_{JA}) ⁽⁵⁾		30°C/W
ESD Rating	Human Body Model ⁽⁶⁾	2500V
	Machine Model ⁽⁶⁾	250V
Storage Temperature		-65°C to +150°C

Soldering process must comply with TI's Reflow Temperature Profile specifications. Refer to www.ti.com/packaging. ⁽⁷⁾

- (1) Absolute Maximum Ratings indicate limits beyond which damage to the device may occur. Operating Ratings indicate conditions for which the device is specified to be functional, but do not ensure specific performance limits. For ensured specifications and test conditions, see the Electrical Characteristics. The ensured specifications apply only for the test conditions listed. Some performance characteristics may degrade when the device is not operated under the listed test conditions. Operation of the device beyond the maximum Operating Ratings is not recommended.
- (2) All voltages are measured with respect to GND = AGND = DRGND = 0V, unless otherwise specified.
- (3) If Military/Aerospace specified devices are required, please contact the TI Sales Office/Distributors for availability and specifications.
- (4) When the input voltage at any pin exceeds the power supplies (that is, $V_{IN} < AGND$, or $V_{IN} > V_A$), the current at that pin should be limited to ± 5 mA. The ± 50 mA maximum package input current rating limits the number of pins that can safely exceed the power supplies with an input current of ± 5 mA to 10.
- (5) The maximum allowable power dissipation is dictated by $T_{J,max}$, the junction-to-ambient thermal resistance, (θ_{JA}), and the ambient temperature, (T_A), and can be calculated using the formula $P_{D,max} = (T_{J,max} - T_A) / \theta_{JA}$. The values for maximum power dissipation listed above will be reached only when the device is operated in a severe fault condition (e.g. when input or output pins are driven beyond the power supply voltages, or the power supply polarity is reversed). Such conditions should always be avoided.
- (6) Human Body Model is 100 pF discharged through a 1.5 k Ω resistor. Machine Model is 220 pF discharged through 0 Ω .
- (7) Reflow temperature profiles are different for lead-free and non-lead-free packages.

Operating Ratings ⁽¹⁾ ⁽²⁾

Operating Temperature		-40°C $\leq T_A \leq$ +85°C
Supply Voltage (V_A)		+2.7V to +3.6V
Output Driver Supply (V_{DR})		2.4V to V_A
Clock Duty Cycle	(DCS Enabled)	30/70 %
	(DCS Disabled)	45/55 %
V_{CM}		1.4V to 1.6V
AGND-DRGND		≤ 100 mV

- (1) Absolute Maximum Ratings indicate limits beyond which damage to the device may occur. Operating Ratings indicate conditions for which the device is specified to be functional, but do not ensure specific performance limits. For ensured specifications and test conditions, see the Electrical Characteristics. The ensured specifications apply only for the test conditions listed. Some performance characteristics may degrade when the device is not operated under the listed test conditions. Operation of the device beyond the maximum Operating Ratings is not recommended.
- (2) All voltages are measured with respect to GND = AGND = DRGND = 0V, unless otherwise specified.

Converter Electrical Characteristics

Unless otherwise specified, the following specifications apply: AGND = DRGND = 0V, $V_A = +3.0V$, $V_{DR} = +2.5V$, Internal $V_{REF} = +1.2V$, $f_{CLK} = 80\text{ MHz}$, $V_{CM} = V_{CMO}$, $C_L = 5\text{ pF/pin}$. Typical values are for $T_A = 25^\circ\text{C}$. **Boldface limits apply for $T_{MIN} \leq T_A \leq T_{MAX}$** . All other limits apply for $T_A = 25^\circ\text{C}$ ⁽¹⁾⁽²⁾

Symbol	Parameter	Conditions	Typical ⁽³⁾	Limits	Units (Limits)
STATIC CONVERTER CHARACTERISTICS					
	Resolution with No Missing Codes			14	Bits (min)
INL	Integral Non Linearity ⁽⁴⁾		± 1.5	4	LSB (max)
				-4	LSB (min)
DNL	Differential Non Linearity		± 0.4	1	LSB (max)
				-0.9	LSB (min)
PGE	Positive Gain Error		0.15	± 1	%FS (max)
NGE	Negative Gain Error		-0.1	± 1	%FS (max)
TC PGE	Positive Gain Error Tempco	$-40^\circ\text{C} \leq T_A \leq +85^\circ\text{C}$	-8		ppm/°C
TC NGE	Negative Gain Error Tempco	$-40^\circ\text{C} \leq T_A \leq +85^\circ\text{C}$	-12		ppm/°C
V_{OFF}	Offset Error		0.1	± 0.55	%FS (max)
TC V_{OFF}	Offset Error Tempco	$-40^\circ\text{C} \leq T_A \leq +85^\circ\text{C}$	10		ppm/°C
	Under Range Output Code		0	0	
	Over Range Output Code		16383	16383	
REFERENCE AND ANALOG INPUT CHARACTERISTICS					
V_{CMO}	Common Mode Output Voltage		1.5	1.45 1.56	V (min) V (max)
V_{CM}	Analog Input Common Mode Voltage		1.5	1.4 1.6	V (min) V (max)
C_{IN}	V_{IN} Input Capacitance (each pin to GND) ⁽⁵⁾	$V_{IN} = 1.5\text{ Vdc} \pm 0.5\text{ V}$	(CLK LOW)	8.5	pF
			(CLK HIGH)	3.5	pF
V_{REF}	Internal Reference Voltage		1.20	1.176 1.224	V (min) V (max)
TC V_{REF}	Internal Reference Voltage Tempco	$-40^\circ\text{C} \leq T_A \leq +85^\circ\text{C}$	18		ppm/°C
V_{RP}	Internal Reference Top		2		V
V_{RN}	Internal Reference Bottom		1		V
	Internal Reference Accuracy	$(V_{RP} - V_{RN})$	1	0.89 1.06	V (Min) V (max)
EXT V_{REF}	External Reference Voltage	See ⁽⁶⁾	1.20	1.176 1.224	V (Min) V (max)

- (1) The inputs are protected as shown below. Input voltage magnitudes above V_A or below GND will not damage this device, provided current is limited per [Absolute Maximum Ratings, Note 4](#). However, errors in the A/D conversion can occur if the input goes above 2.6V or below GND as described in the [Operating Ratings](#) section.

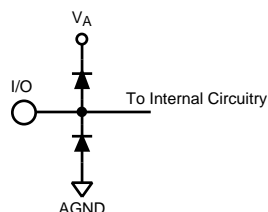

- (2) With a full scale differential input of $2V_{P-P}$, the 14-bit LSB is $122.1\text{ }\mu\text{V}$.
 (3) Typical figures are at $T_A = 25^\circ\text{C}$ and represent most likely parametric norms at the time of product characterization. The typical specifications are not ensured.
 (4) Integral Non Linearity is defined as the deviation of the analog value, expressed in LSBs, from the straight line that passes through positive and negative full-scale.
 (5) The input capacitance is the sum of the package/pin capacitance and the sample and hold circuit capacitance.
 (6) This parameter is specified by design and/or characterization and is not tested in production.

Dynamic Converter Electrical Characteristics

Unless otherwise specified, the following specifications apply: $AGND = DRGND = 0V$, $V_A = +3.0V$, $V_{DR} = +2.5V$, Internal $V_{REF} = +1.2V$, $f_{CLK} = 80\text{ MHz}$, $V_{CM} = V_{CMO}$, $C_L = 5\text{ pF/pin}$, . Typical values are for $T_A = 25^\circ C$. **Boldface limits apply for $T_{MIN} \leq T_A \leq T_{MAX}$** . All other limits apply for $T_A = 25^\circ C$ ⁽¹⁾ ⁽²⁾

Symbol	Parameter	Conditions	Typical ⁽³⁾	Limits	Units (Limits) ⁽⁴⁾
DYNAMIC CONVERTER CHARACTERISTICS, $A_{IN} = -1\text{dBFS}$					
FPBW	Full Power Bandwidth	-1 dBFS Input, -3 dB Corner	1.0		GHz
SNR	Signal-to-Noise Ratio	$f_{IN} = 10\text{ MHz}$	74		dBFS
		$f_{IN} = 70\text{ MHz}$	73.5		dBFS
		$f_{IN} = 170\text{ MHz}$	71	70	dBFS
SFDR	Spurious Free Dynamic Range	$f_{IN} = 10\text{ MHz}$	90		dBFS
		$f_{IN} = 70\text{ MHz}$	86		dBFS
		$f_{IN} = 170\text{ MHz}$	83	78	dBFS
ENOB	Effective Number of Bits	$f_{IN} = 10\text{ MHz}$	12		Bits
		$f_{IN} = 70\text{ MHz}$	11.9		Bits
		$f_{IN} = 170\text{ MHz}$	11.4	11.1	Bits
THD	Total Harmonic Distortion	$f_{IN} = 10\text{ MHz}$	-86		dBFS
		$f_{IN} = 70\text{ MHz}$	-85		dBFS
		$f_{IN} = 170\text{ MHz}$	-82	-77	dBFS
H2	Second Harmonic Distortion	$f_{IN} = 10\text{ MHz}$	-95		dBFS
		$f_{IN} = 70\text{ MHz}$	-90		dBFS
		$f_{IN} = 170\text{ MHz}$	-83	-78	dBFS
H3	Third Harmonic Distortion	$f_{IN} = 10\text{ MHz}$	-90		dBFS
		$f_{IN} = 70\text{ MHz}$	-85		dBFS
		$f_{IN} = 170\text{ MHz}$	-83	-78	dBFS
SINAD	Signal-to-Noise and Distortion Ratio	$f_{IN} = 10\text{ MHz}$	73.7		dBFS
		$f_{IN} = 70\text{ MHz}$	73.2		dBFS
		$f_{IN} = 170\text{ MHz}$	70.7	69.2	dBFS
IMD	Intermodulation Distortion	$f_{IN} = 20\text{ MHz}$ and 21 MHz , each -7dBFS	-84		dBFS
	Crosstalk	0 MHz tested channel, $f_{IN} = 10\text{ MHz}$ at -1dBFS other channel	-100		dBFS

- (1) The inputs are protected as shown below. Input voltage magnitudes above V_A or below GND will not damage this device, provided current is limited per [Absolute Maximum Ratings, Note 4](#). However, errors in the A/D conversion can occur if the input goes above 2.6V or below GND as described in the [Operating Ratings](#) section.

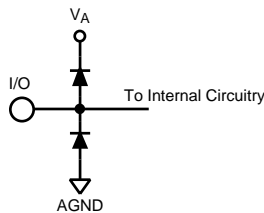

- (2) With a full scale differential input of $2V_{P,P}$, the 14-bit LSB is $122.1\text{ }\mu V$.
 (3) Typical figures are at $T_A = 25^\circ C$ and represent most likely parametric norms at the time of product characterization. The typical specifications are not ensured.
 (4) This parameter is specified in units of dBFS - indicating the value that would be attained with a full-scale input signal.

Logic and Power Supply Electrical Characteristics

Unless otherwise specified, the following specifications apply: AGND = DRGND = 0V, $V_A = +3.0V$, $V_{DR} = +2.5V$, Internal $V_{REF} = +1.2V$, $f_{CLK} = 80\text{ MHz}$, $V_{CM} = V_{CMO}$, $C_L = 5\text{ pF/pin}$. Typical values are for $T_A = 25^\circ\text{C}$. **Boldface limits apply for $T_{MIN} \leq T_A \leq T_{MAX}$** . All other limits apply for $T_A = 25^\circ\text{C}$ ⁽¹⁾ ⁽²⁾

Symbol	Parameter	Conditions	Typical ⁽³⁾	Limits	Units (Limits)
DIGITAL INPUT CHARACTERISTICS (CLK, PD_A, PD_B)					
$V_{IN(1)}$	Logical "1" Input Voltage	$V_A = 3.3V$		2.0	V (min)
$V_{IN(0)}$	Logical "0" Input Voltage	$V_A = 3.0V$		0.8	V (max)
$I_{IN(1)}$	Logical "1" Input Current	$V_{IN} = 3.3V$	10		μA
$I_{IN(0)}$	Logical "0" Input Current	$V_{IN} = 0V$	-10		μA
C_{IN}	Digital Input Capacitance		5		pF
DIGITAL OUTPUT CHARACTERISTICS (DA0-DA13, DB0-DB13, DRDY)					
$V_{OUT(1)}$	Logical "1" Output Voltage	$I_{OUT} = -0.5\text{ mA}$, $V_{DR} = 2.4V$		2.0	V (min)
$V_{OUT(0)}$	Logical "0" Output Voltage	$I_{OUT} = 1.6\text{ mA}$, $V_{DR} = 2.4V$		0.4	V (max)
+ I_{SC}	Output Short Circuit Source Current	$V_{OUT} = 0V$	-10		mA
- I_{SC}	Output Short Circuit Sink Current	$V_{OUT} = V_{DR}$	10		mA
C_{OUT}	Digital Output Capacitance		5		pF
POWER SUPPLY CHARACTERISTICS					
I_A	Analog Supply Current	Full Operation	200	233	mA (max)
I_{DR}	Digital Output Supply Current	Full Operation ⁽⁴⁾	26		mA
	Power Consumption	Excludes I_{DR} ⁽⁴⁾	600	700	mW (max)
	Power Down Power Consumption	$PD_A=PD_B=V_A$	33		mW

- (1) The inputs are protected as shown below. Input voltage magnitudes above V_A or below GND will not damage this device, provided current is limited per [Absolute Maximum Ratings, Note 4](#). However, errors in the A/D conversion can occur if the input goes above 2.6V or below GND as described in the [Operating Ratings](#) section.

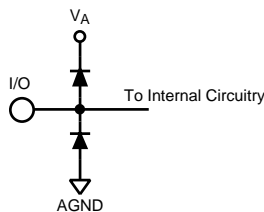

- (2) With a full scale differential input of $2V_{P-P}$, the 14-bit LSB is $122.1\text{ }\mu\text{V}$.
- (3) Typical figures are at $T_A = 25^\circ\text{C}$ and represent most likely parametric norms at the time of product characterization. The typical specifications are not ensured.
- (4) I_{DR} is the current consumed by the switching of the output drivers and is primarily determined by load capacitance on the output pins, the supply voltage, V_{DR} , and the rate at which the outputs are switching (which is signal dependent). $I_{DR} = V_{DR}(C_0 \times f_0 + C_1 \times f_1 + \dots + C_{13} \times f_{13})$ where V_{DR} is the output driver power supply voltage, C_n is total capacitance on the output pin, and f_n is the average frequency at which that pin is toggling.

Timing and AC Characteristics

Unless otherwise specified, the following specifications apply: AGND = DRGND = 0V, $V_A = +3.0V$, $V_{DR} = +2.5V$, Internal $V_{REF} = +1.2V$, $f_{CLK} = 80\text{ MHz}$, $V_{CM} = V_{CMO}$, $C_L = 5\text{ pF/pin}$. Typical values are for $T_A = 25^\circ\text{C}$. Timing measurements are taken at 50% of the signal amplitude. **Boldface limits apply for $T_{MIN} \leq T_A \leq T_{MAX}$** . All other limits apply for $T_A = 25^\circ\text{C}$ ^{(1) (2)}

Symbol	Parameter	Conditions	Typical ⁽³⁾	Limits	Units (Limits)
	Maximum Clock Frequency			80	MHz (max)
	Minimum Clock Frequency			20	MHz (min)
t_{CH}	Clock High Time		6		ns
t_{CL}	Clock Low Time		6		ns
t_{CONV}	Conversion Latency			7	Clock Cycles
t_{OD}	Output Delay of CLK to DATA	Relative to rising edge of CLK	6.8	4.7 8.9	ns (min) ns (max)
t_{SU}	Data Output Setup Time	Relative to DRDY	5.8	4	ns (min)
t_H	Data Output Hold Time	Relative to DRDY	6.6	4.6	ns (min)
t_{AD}	Aperture Delay		0.6		ns
t_{AJ}	Aperture Jitter		0.1		ps rms

- (1) The inputs are protected as shown below. Input voltage magnitudes above V_A or below GND will not damage this device, provided current is limited per [Absolute Maximum Ratings, Note 4](#). However, errors in the A/D conversion can occur if the input goes above 2.6V or below GND as described in the [Operating Ratings](#) section.

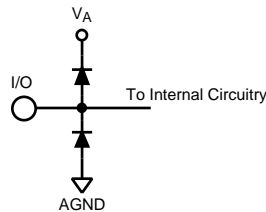

- (2) With a full scale differential input of $2V_{P,P}$, the 14-bit LSB is $122.1\ \mu\text{V}$.
- (3) Typical figures are at $T_A = 25^\circ\text{C}$ and represent most likely parametric norms at the time of product characterization. The typical specifications are not ensured.

Specification Definitions

APERTURE DELAY is the time after the falling edge of the clock to when the input signal is acquired or held for conversion.

APERTURE JITTER (APERTURE UNCERTAINTY) is the variation in aperture delay from sample to sample. Aperture jitter manifests itself as noise in the output.

CLOCK DUTY CYCLE is the ratio of the time during one cycle that a repetitive digital waveform is high to the total time of one period. The specification here refers to the ADC clock input signal.

COMMON MODE VOLTAGE (V_{CM}) is the common DC voltage applied to both input terminals of the ADC.

CONVERSION LATENCY is the number of clock cycles between initiation of conversion and when that data is presented to the output driver stage. Data for any given sample is available at the output pins the Pipeline Delay plus the Output Delay after the sample is taken. New data is available at every clock cycle, but the data lags the conversion by the pipeline delay.

CROSSTALK is coupling of energy from one channel into the other channel.

DIFFERENTIAL NON-LINEARITY (DNL) is the measure of the maximum deviation from the ideal step size of 1 LSB.

EFFECTIVE NUMBER OF BITS (ENOB, or EFFECTIVE BITS) is another method of specifying Signal-to-Noise and Distortion Ratio or SINAD. ENOB is defined as $(\text{SINAD} - 1.76) / 6.02$ and says that the converter is equivalent to a perfect ADC of this (ENOB) number of bits.

FULL POWER BANDWIDTH is a measure of the frequency at which the reconstructed output fundamental drops 3 dB below its low frequency value for a full scale input.

GAIN ERROR is the deviation from the ideal slope of the transfer function. It can be calculated as:

$$\text{Gain Error} = \text{Positive Full Scale Error} - \text{Negative Full Scale Error} \quad (1)$$

It can also be expressed as Positive Gain Error and Negative Gain Error, which are calculated as:

$$\text{PGE} = \text{Positive Full Scale Error} - \text{Offset Error} \quad \text{NGE} = \text{Offset Error} - \text{Negative Full Scale Error} \quad (2)$$

INTEGRAL NON LINEARITY (INL) is a measure of the deviation of each individual code from a best fit straight line. The deviation of any given code from this straight line is measured from the center of that code value.

INTERMODULATION DISTORTION (IMD) is the creation of additional spectral components as a result of two sinusoidal frequencies being applied to the ADC input at the same time. It is defined as the ratio of the power in the intermodulation products to the total power in the original frequencies. IMD is usually expressed in dBFS.

LSB (LEAST SIGNIFICANT BIT) is the bit that has the smallest value or weight of all bits. This value is $V_{FS}/2^n$, where " V_{FS} " is the full scale input voltage and "n" is the ADC resolution in bits.

MISSING CODES are those output codes that will never appear at the ADC outputs. The ADC is ensured not to have any missing codes.

MSB (MOST SIGNIFICANT BIT) is the bit that has the largest value or weight. Its value is one half of full scale.

NEGATIVE FULL SCALE ERROR is the difference between the actual first code transition and its ideal value of $1/2$ LSB above negative full scale.

OFFSET ERROR is the difference between the two input voltages $[(V_{IN+}) - (V_{IN-})]$ required to cause a transition from code 8191 to 8192.

OUTPUT DELAY is the time delay after the falling edge of the clock before the data update is presented at the output pins.

PIPELINE DELAY (LATENCY) See CONVERSION LATENCY.

POSITIVE FULL SCALE ERROR is the difference between the actual last code transition and its ideal value of $1\frac{1}{2}$ LSB below positive full scale.

POWER SUPPLY REJECTION RATIO (PSRR) is a measure of how well the ADC rejects a change in the power supply voltage. PSRR is the ratio of the Full-Scale output of the ADC with the supply at the minimum DC supply limit to the Full-Scale output of the ADC with the supply at the maximum DC supply limit, expressed in dB.

SIGNAL TO NOISE RATIO (SNR) is the ratio, expressed in dB, of the rms value of the input signal to the rms value of the sum of all other spectral components below one-half the sampling frequency, not including harmonics or DC.

SIGNAL TO NOISE PLUS DISTORTION (S/N+D or SINAD) Is the ratio, expressed in dB, of the rms value of the input signal to the rms value of all of the other spectral components below half the clock frequency, including harmonics but excluding d.c.

SPURIOUS FREE DYNAMIC RANGE (SFDR) is the difference, expressed in dB, between the rms values of the input signal and the peak spurious signal, where a spurious signal is any signal present in the output spectrum that is not present at the input.

TOTAL HARMONIC DISTORTION (THD) is the ratio, expressed in dB, of the rms total of the first six harmonic levels at the output to the level of the fundamental at the output. THD is calculated as:

$$\text{THD} = 20 \times \log \sqrt{\frac{f_2^2 + \dots + f_7^2}{f_1^2}} \quad (3)$$

where f_1 is the RMS power of the fundamental (output) frequency and f_2 through f_7 are the RMS power of the first six harmonic frequencies in the output spectrum.

SECOND HARMONIC DISTORTION (2ND HARM) is the difference expressed in dB, between the RMS power in the input frequency at the output and the power in its 2nd harmonic level at the output.

THIRD HARMONIC DISTORTION (3RD HARM) is the difference, expressed in dB, between the RMS power in the input frequency at the output and the power in its 3rd harmonic level at the output.

Timing Diagrams

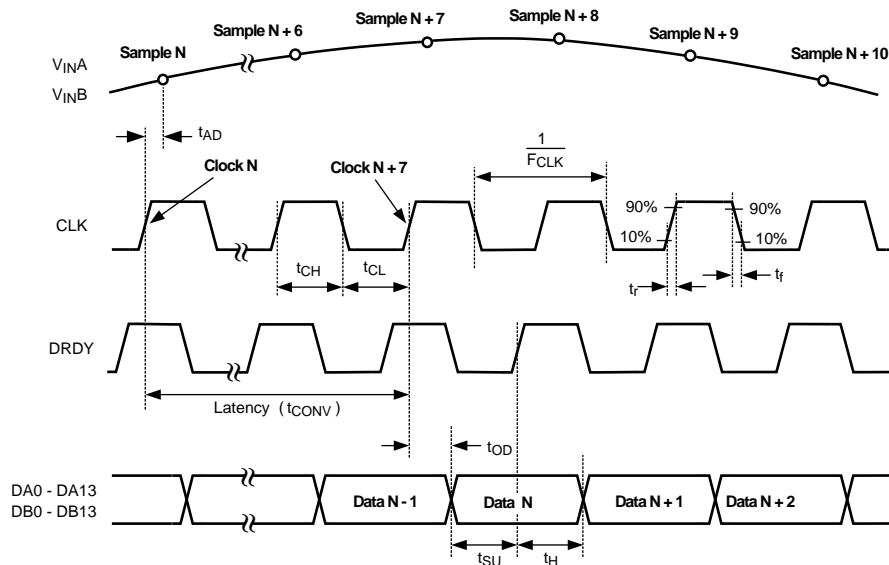

Figure 1. Output Timing

Transfer Characteristic

Output Code

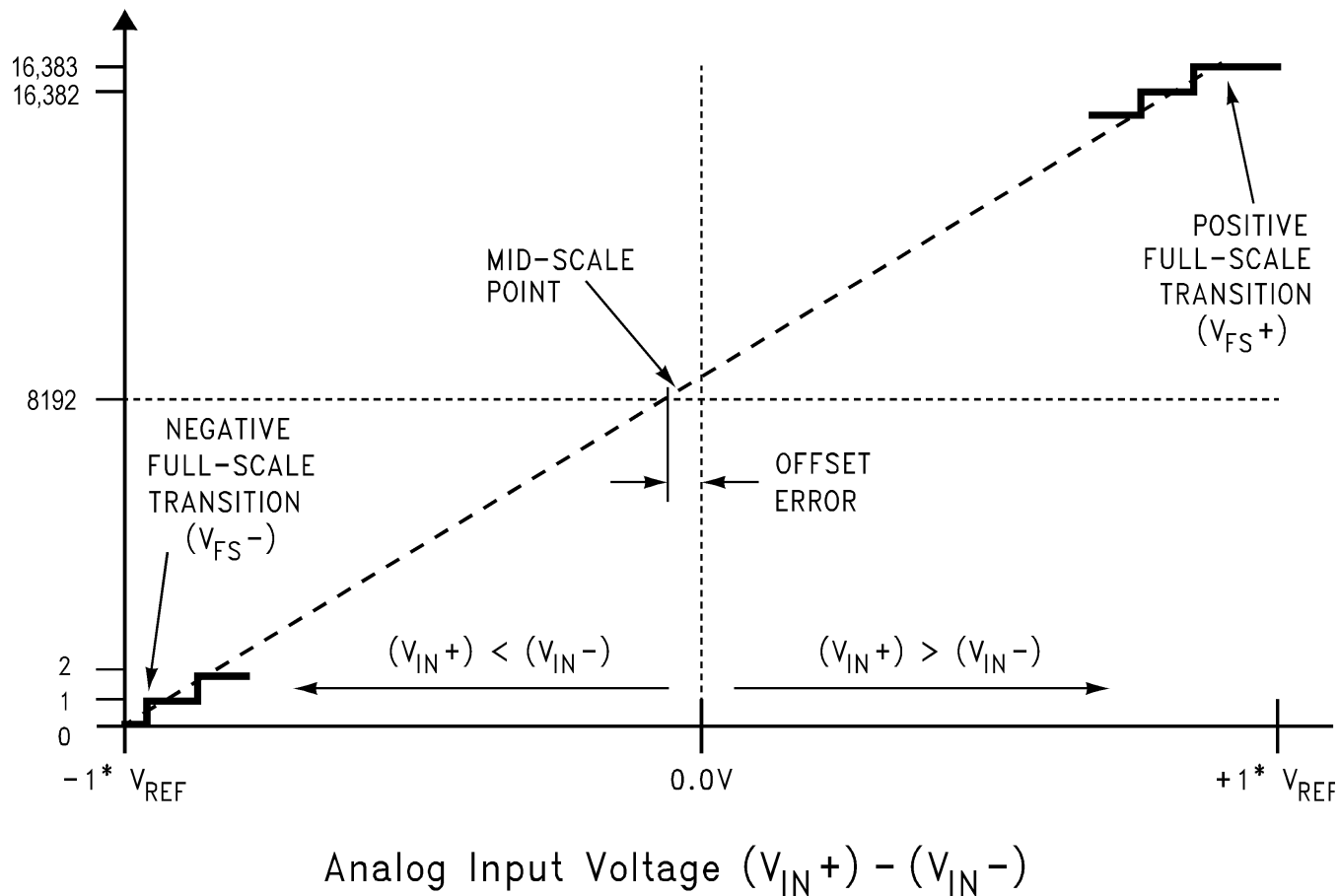

Figure 2. Transfer Characteristic

Typical Performance Characteristics DNL, INL

Unless otherwise specified, the following specifications apply: $V_{AGND} = V_{DRGND} = 0V$, $V_A = +3.3V$, $V_{DR} = +2.5V$, Internal $V_{REF} = +1.2V$, $f_{CLK} = 105\text{ MHz}$, 50% Duty Cycle, DCS disabled, $V_{CM} = V_{CMO}$, $T_A = 25^\circ\text{C}$.

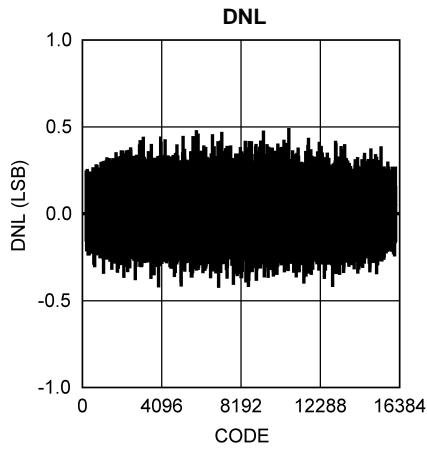

Figure 3.

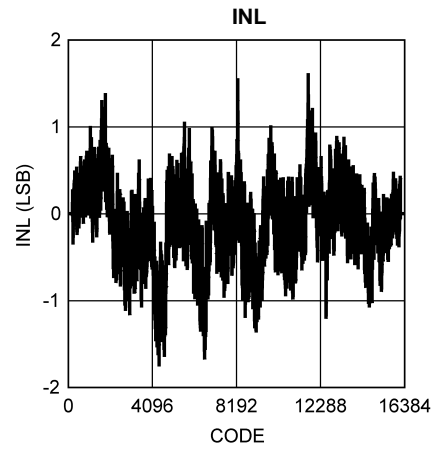

Figure 4.

Typical Performance Characteristics

Unless otherwise specified, the following specifications apply: AGND = DRGND = 0V, $V_A = +3.3V$, $V_{DR} = +2.5V$, Internal $V_{REF} = +1.2V$, $f_{CLK} = 105\text{ MHz}$, 50% Duty Cycle, DCS disabled, $V_{CM} = V_{CMO}$, $f_{IN} = 170\text{ MHz}$, $T_A = 25^\circ\text{C}$.

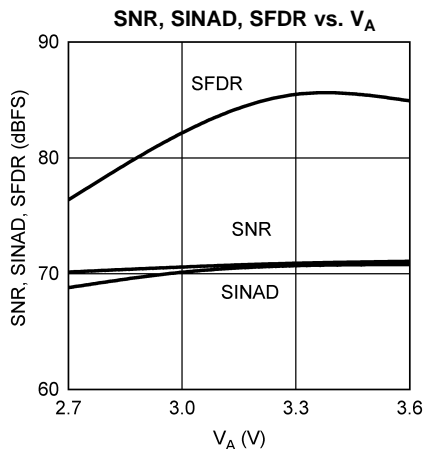

Figure 5.

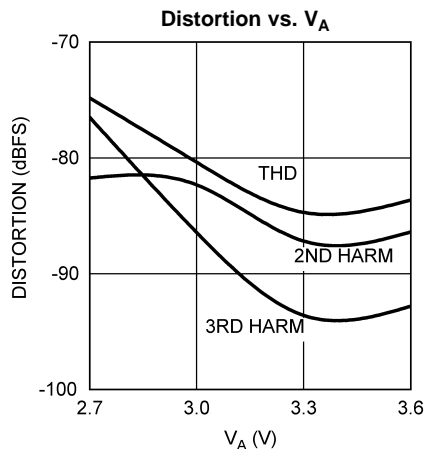

Figure 6.

SNR, SINAD, SFDR vs. Clock Duty Cycle, $f_{IN}=40\text{ MHz}$

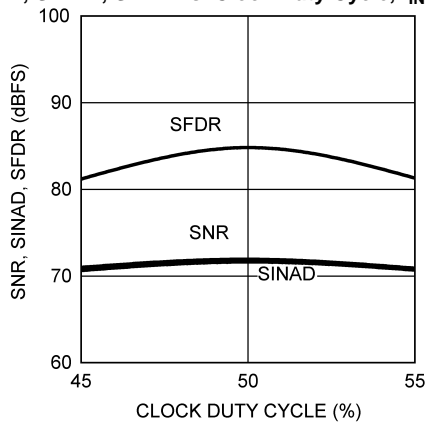

Figure 7.

Distortion vs. Clock Duty Cycle, $f_{IN}=40\text{ MHz}$

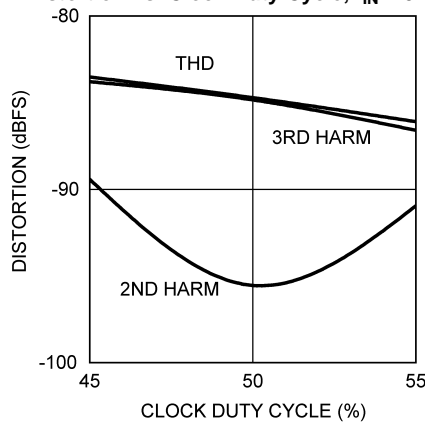

Figure 8.

SNR, SINAD, SFDR vs. Clock Duty Cycle, DCS Enabled, $f_{IN}=40\text{ MHz}$

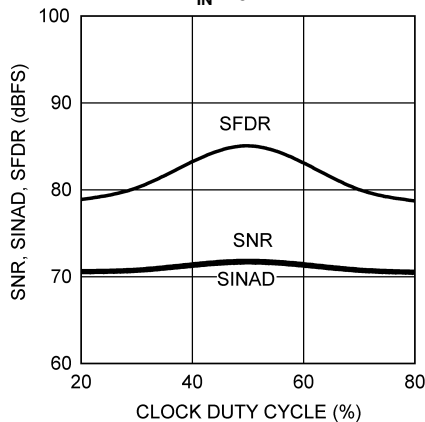

Figure 9.

Distortion vs. Clock Duty Cycle, DCS Enabled, $f_{IN}=40\text{ MHz}$

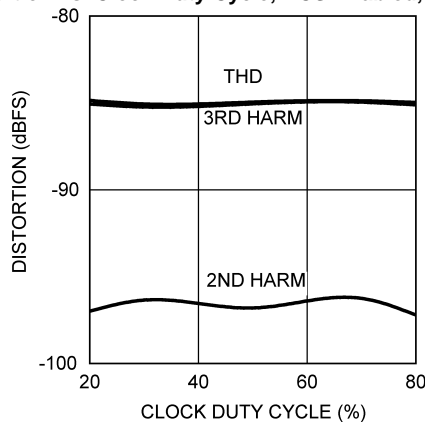

Figure 10.

Typical Performance Characteristics (continued)

Unless otherwise specified, the following specifications apply: AGND = DRGND = 0V, $V_A = +3.3V$, $V_{DR} = +2.5V$, Internal $V_{REF} = +1.2V$, $f_{CLK} = 105\text{ MHz}$, 50% Duty Cycle, DCS disabled, $V_{CM} = V_{CMO}$, $f_{IN} = 170\text{ MHz}$, $T_A = 25^\circ\text{C}$.

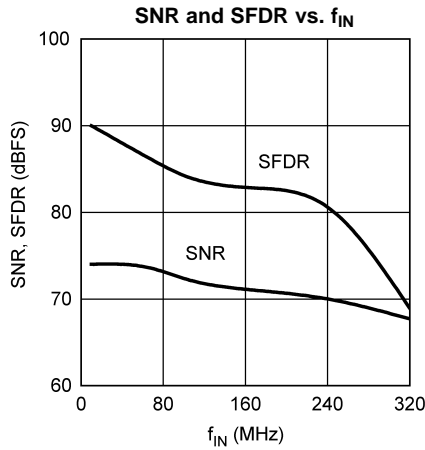

Figure 11.

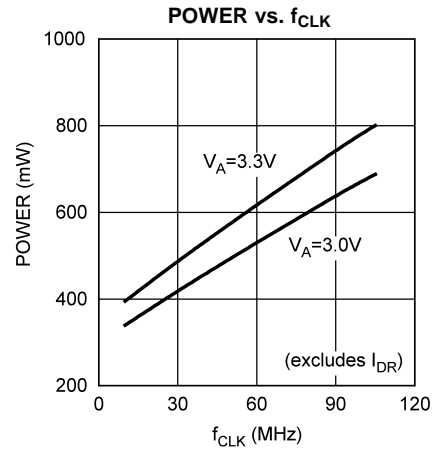

Figure 12.

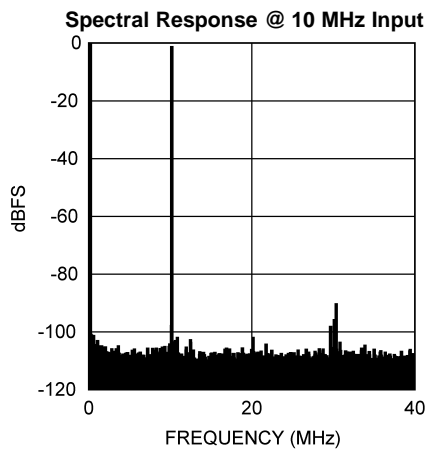

Figure 13.

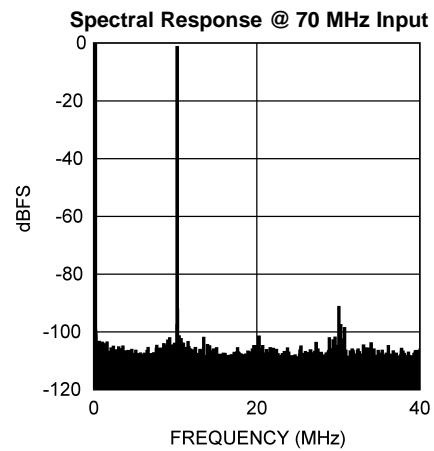

Figure 14.

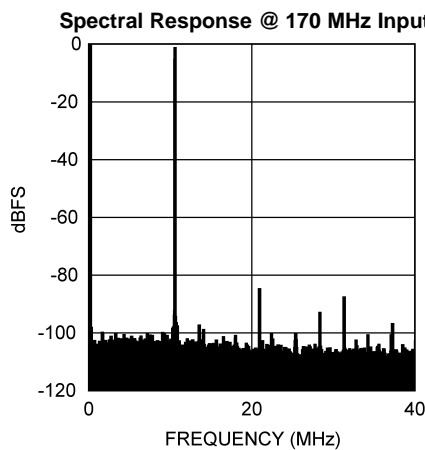

Figure 15.

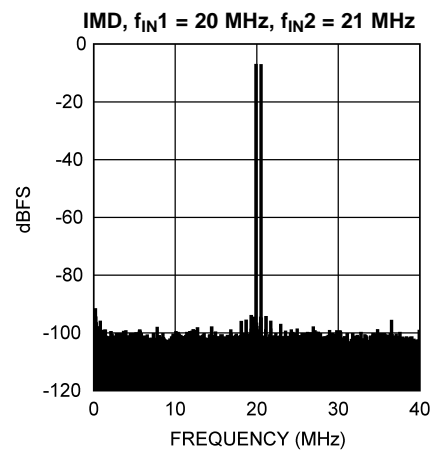

Figure 16.

FUNCTIONAL DESCRIPTION

Operating on a single +3.0V supply, the ADC14DC080 digitizes two differential analog input signals to 14 bits, using a differential pipelined architecture with error correction circuitry and an on-chip sample-and-hold circuit to ensure maximum performance. The user has the choice of using an internal 1.2V stable reference, or using an external 1.2V reference. Any external reference is buffered on-chip to ease the task of driving that pin. Duty cycle stabilization and output data format are selectable using the quad state function OF/DCS pin (pin 19). The output data can be set for offset binary or two's complement.

Applications Information

OPERATING CONDITIONS

We recommend that the following conditions be observed for operation of the ADC14DC080:

$$2.7V \leq V_A \leq 3.6V$$

$$2.4V \leq V_{DR} \leq V_A$$

$$20 \text{ MHz} \leq f_{CLK} \leq 80 \text{ MHz}$$

1.2V internal reference

$$V_{REF} = 1.2V \text{ (for an external reference)}$$

$$V_{CM} = 1.5V \text{ (from } V_{CMO})$$

ANALOG INPUTS

Signal Inputs

Differential Analog Input Pins

The ADC14DC080 has a pair of analog signal input pins for each of two channels. V_{IN+} and V_{IN-} form a differential input pair. The input signal, V_{IN} , is defined as:

$$V_{IN} = (V_{IN+}) - (V_{IN-}) \quad (4)$$

Figure 17 shows the expected input signal range. Note that the common mode input voltage, V_{CM} , should be 1.5V. Using V_{CMO} (pins 7,9) for V_{CM} will ensure the proper input common mode level for the analog input signal. The positive peaks of the individual input signals should each never exceed 2.6V. Each analog input pin of the differential pair should have a maximum peak-to-peak voltage of 1V, be 180° out of phase with each other and be centered around V_{CM} . The peak-to-peak voltage swing at each analog input pin should not exceed the 1V or the output data will be clipped.

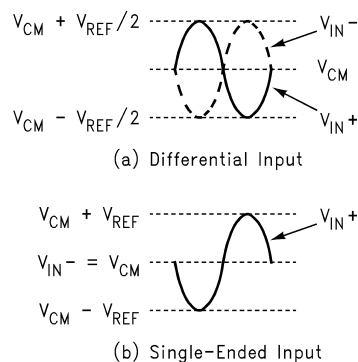

Figure 17. Expected Input Signal Range

For single frequency sine waves the full scale error in LSB can be described as approximately:

$$E_{FS} = 16384 (1 - \sin(90^\circ + \text{dev})) \quad (5)$$

Where dev is the angular difference in degrees between the two signals having a 180° relative phase relationship to each other (see Figure 18). For single frequency inputs, angular errors result in a reduction of the effective full scale input. For complex waveforms, however, angular errors will result in distortion.

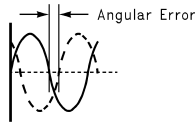

Figure 18. Angular Errors Between the Two Input Signals Will Reduce the Output Level or Cause Distortion

It is recommended to drive the analog inputs with a source impedance less than 100Ω . Matching the source impedance for the differential inputs will improve even ordered harmonic performance (particularly second harmonic).

Table 1 indicates the input to output relationship of the ADC14DC080.

Table 1. Input to Output Relationship

V_{IN}^+	V_{IN}^-	Binary Output	2's Complement Output	
$V_{CM} - V_{REF}/2$	$V_{CM} + V_{REF}/2$	00 0000 0000 0000	10 0000 0000 0000	Negative Full-Scale
$V_{CM} - V_{REF}/4$	$V_{CM} + V_{REF}/4$	01 0000 0000 0000	11 0000 0000 0000	
V_{CM}	V_{CM}	10 0000 0000 0000	00 0000 0000 0000	Mid-Scale
$V_{CM} + V_{REF}/4$	$V_{CM} - V_{REF}/4$	11 0000 0000 0000	01 0000 0000 0000	
$V_{CM} + V_{REF}/2$	$V_{CM} - V_{REF}/2$	11 1111 1111 1111	01 1111 1111 1111	Positive Full-Scale

Driving the Analog Inputs

The V_{IN}^+ and the V_{IN}^- inputs of the ADC14DC080 have an internal sample-and-hold circuit which consists of an analog switch followed by a switched-capacitor amplifier.

Figure 19 and Figure 20 show examples of single-ended to differential conversion circuits. The circuit in Figure 19 works well for input frequencies up to approximately 70MHz, while the circuit in Figure 20 works well above 70MHz.

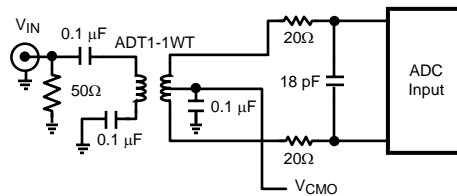

Figure 19. Low Input Frequency Transformer Drive Circuit

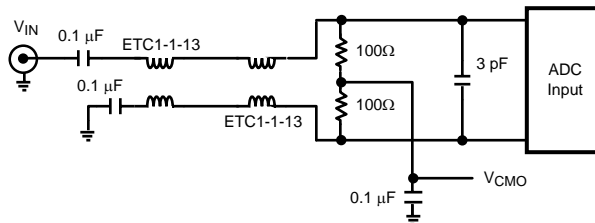

Figure 20. High Input Frequency Transformer Drive Circuit

One short-coming of using a transformer to achieve the single-ended to differential conversion is that most RF transformers have poor low frequency performance. A differential amplifier can be used to drive the analog inputs for low frequency applications. The amplifier must be fast enough to settle from the charging glitches on the analog input resulting from the sample-and-hold operation before the clock goes high and the sample is passed to the ADC core.

Input Common Mode Voltage

The input common mode voltage, V_{CM} , should be in the range of 1.4V to 1.6V and be a value such that the peak excursions of the analog signal do not go more negative than ground or more positive than 2.6V. It is recommended to use V_{CMO} (pins 7,9) as the input common mode voltage.

Reference Pins

The ADC14DC080 is designed to operate with an internal or external 1.2V reference. The internal 1.2 Volt reference is the default condition when no external reference input is applied to the V_{REF} pin. If a voltage is applied to the V_{REF} pin, then that voltage is used for the reference. The V_{REF} pin should always be bypassed to ground with a 0.1 μ F capacitor close to the reference input pin.

It is important that all grounds associated with the reference voltage and the analog input signal make connection to the ground plane at a single, quiet point to minimize the effects of noise currents in the ground path.

The Reference Bypass Pins (V_{RP} , V_{CMO} , and V_{RN}) for channels A and B are made available for bypass purposes. These pins should each be bypassed to AGND with a low ESL (equivalent series inductance) 1 μ F capacitor placed very close to the pin to minimize stray inductance. A 0.1 μ F capacitor should be placed between V_{RP} and V_{RN} as close to the pins as possible, and a 1 μ F capacitor should be placed in parallel. This configuration is shown in [Figure 21](#). It is necessary to avoid reference oscillation, which could result in reduced SFDR and/or SNR. V_{CMO} may be loaded to 1mA for use as a temperature stable 1.5V reference. The remaining pins should not be loaded.

Smaller capacitor values than those specified will allow faster recovery from the power down mode, but may result in degraded noise performance. Loading any of these pins, other than V_{CMO} may result in performance degradation.

The nominal voltages for the reference bypass pins are as follows:

$$V_{CMO} = 1.5 \text{ V}$$

$$V_{RP} = 2.0 \text{ V}$$

$$V_{RN} = 1.0 \text{ V}$$

OF/DCS Pin

Duty cycle stabilization and output data format are selectable using this quad state function pin. When enabled, duty cycle stabilization can compensate for clock inputs with duty cycles ranging from 30% to 70% and generate a stable internal clock, improving the performance of the part. With OF/DCS = V_A the output data format is 2's complement and duty cycle stabilization is not used. With OF/DCS = AGND the output data format is offset binary and duty cycle stabilization is not used. With OF/DCS = $(2/3)*V_A$ the output data format is 2's complement and duty cycle stabilization is applied to the clock. If OF/DCS is $(1/3)*V_A$ the output data format is offset binary and duty cycle stabilization is applied to the clock. While the sense of this pin may be changed "on the fly," doing this is not recommended as the output data could be erroneous for a few clock cycles after this change is made.

NOTE

This signal has no effect when SPI_EN is high and the serial control interface is enabled.

DIGITAL INPUTS

Digital CMOS compatible inputs consist of CLK, PD_A, and PD_B.

Clock Input

The CLK controls the timing of the sampling process. To achieve the optimum noise performance, the clock input should be driven with a stable, low jitter clock signal in the range indicated in the [Electrical Table](#). The clock input signal should also have a short transition region. This can be achieved by passing a low-jitter sinusoidal clock source through a high speed buffer gate. The trace carrying the clock signal should be as short as possible and should not cross any other signal line, analog or digital, not even at 90°.

The clock signal also drives an internal state machine. If the clock is interrupted, or its frequency is too low, the charge on the internal capacitors can dissipate to the point where the accuracy of the output data will degrade. This is what limits the minimum sample rate.

The clock line should be terminated at its source in the characteristic impedance of that line. Take care to maintain a constant clock line impedance throughout the length of the line. Refer to Application Note AN-905 ([SNLA035](#)) for information on setting characteristic impedance.

It is highly desirable that the the source driving the ADC clock pins only drive that pin. However, if that source is used to drive other devices, then each driven pin should be AC terminated with a series RC to ground, such that the resistor value is equal to the characteristic impedance of the clock line and the capacitor value is:

$$C \geq \frac{4 \times t_{PD} \times L}{Z_0} \quad (6)$$

where t_{PD} is the signal propagation rate down the clock line, "L" is the line length and Z_0 is the characteristic impedance of the clock line. This termination should be as close as possible to the ADC clock pin but beyond it as seen from the clock source. Typical t_{PD} is about 150 ps/inch (60 ps/cm) on FR-4 board material. The units of "L" and t_{PD} should be the same (inches or centimeters).

The duty cycle of the clock signal can affect the performance of the A/D Converter. Because achieving a precise duty cycle is difficult, the ADC14DC080 has a Duty Cycle Stabilizer.

DIGITAL OUTPUTS

Digital outputs consist of the CMOS signals DA0-DA13, DB0-DB13, and DRDY.

The ADC14DC080 has 14 CMOS compatible data output pins corresponding to the converted input value for each channel, and a data ready (DRDY) signal that should be used to capture the output data. Valid data is present at these outputs while the PD pin is low. Data should be captured and latched with the rising edge of the DRDY signal.

Be very careful when driving a high capacitance bus. The more capacitance the output drivers must charge for each conversion, the more instantaneous digital current flows through V_{DR} and DRGND. These large charging current spikes can cause on-chip ground noise and couple into the analog circuitry, degrading dynamic performance. Adequate bypassing, limiting output capacitance and careful attention to the ground plane will reduce this problem. The result could be an apparent reduction in dynamic performance.

Generally, analog and digital lines should cross each other at 90° to avoid crosstalk. To maximize accuracy in high speed, high resolution systems, however, avoid crossing analog and digital lines altogether. It is important to keep clock lines as short as possible and isolated from ALL other lines, including other digital lines. Even the generally accepted 90° crossing should be avoided with the clock line as even a little coupling can cause problems at high frequencies. This is because other lines can introduce jitter into the clock line, which can lead to degradation of SNR. Also, the high speed clock can introduce noise into the analog chain.

Best performance at high frequencies and at high resolution is obtained with a straight signal path. That is, the signal path through all components should form a straight line wherever possible.

Be especially careful with the layout of inductors and transformers. Mutual inductance can change the characteristics of the circuit in which they are used. Inductors and transformers should *not* be placed side by side, even with just a small part of their bodies beside each other. For instance, place transformers for the analog input and the clock input at 90° to one another to avoid magnetic coupling.

The analog input should be isolated from noisy signal traces to avoid coupling of spurious signals into the input. Any external component (e.g., a filter capacitor) connected between the converter's input pins and ground or to the reference input pin and ground should be connected to a very clean point in the ground plane.

All analog circuitry (input amplifiers, filters, reference components, etc.) should be placed in the analog area of the board. All digital circuitry and dynamic I/O lines should be placed in the digital area of the board. The ADC14DC080 should be between these two areas. Furthermore, all components in the reference circuitry and the input signal chain that are connected to ground should be connected together with short traces and enter the ground plane at a single, quiet point. All ground connections should have a low inductance path to ground.

DYNAMIC PERFORMANCE

To achieve the best dynamic performance, the clock source driving the CLK input must have a sharp transition region and be free of jitter. Isolate the ADC clock from any digital circuitry with buffers, as with the clock tree shown in [Figure 22](#). The gates used in the clock tree must be capable of operating at frequencies much higher than those used if added jitter is to be prevented.

As mentioned in [Section Clock Input](#), it is good practice to keep the ADC clock line as short as possible and to keep it well away from any other signals. Other signals can introduce jitter into the clock signal, which can lead to reduced SNR performance, and the clock can introduce noise into other lines. Even lines with 90° crossings have capacitive coupling, so try to avoid even these 90° crossings of the clock line.

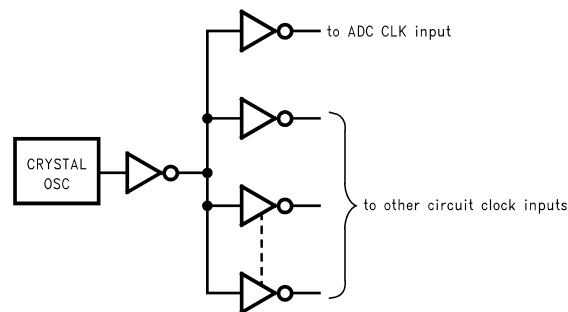

Figure 22. Isolating the ADC Clock from other Circuitry with a Clock Tree

REVISION HISTORY

Changes from Revision A (April 2013) to Revision B	Page
<hr/> <ul style="list-style-type: none">• Changed layout of National Data Sheet to TI format	<hr/> 20

PACKAGING INFORMATION

Orderable Device	Status (1)	Package Type	Package Drawing	Pins	Package Qty	Eco Plan (2)	Lead/Ball Finish (6)	MSL Peak Temp (3)	Op Temp (°C)	Device Marking (4/5)	Samples
ADC14DC080CISQE/NOPB	ACTIVE	WQFN	NKA	60	250	Green (RoHS & no Sb/Br)	CU SN	Level-3-260C-168 HR	-40 to 85	14DC080 CISQ	Samples

(1) The marketing status values are defined as follows:

ACTIVE: Product device recommended for new designs.

LIFEBUY: TI has announced that the device will be discontinued, and a lifetime-buy period is in effect.

NRND: Not recommended for new designs. Device is in production to support existing customers, but TI does not recommend using this part in a new design.

PREVIEW: Device has been announced but is not in production. Samples may or may not be available.

OBSELETE: TI has discontinued the production of the device.

(2) Eco Plan - The planned eco-friendly classification: Pb-Free (RoHS), Pb-Free (RoHS Exempt), or Green (RoHS & no Sb/Br) - please check <http://www.ti.com/productcontent> for the latest availability information and additional product content details.

TBD: The Pb-Free/Green conversion plan has not been defined.

Pb-Free (RoHS): TI's terms "Lead-Free" or "Pb-Free" mean semiconductor products that are compatible with the current RoHS requirements for all 6 substances, including the requirement that lead not exceed 0.1% by weight in homogeneous materials. Where designed to be soldered at high temperatures, TI Pb-Free products are suitable for use in specified lead-free processes.

Pb-Free (RoHS Exempt): This component has a RoHS exemption for either 1) lead-based flip-chip solder bumps used between the die and package, or 2) lead-based die adhesive used between the die and leadframe. The component is otherwise considered Pb-Free (RoHS compatible) as defined above.

Green (RoHS & no Sb/Br): TI defines "Green" to mean Pb-Free (RoHS compatible), and free of Bromine (Br) and Antimony (Sb) based flame retardants (Br or Sb do not exceed 0.1% by weight in homogeneous material)

(3) MSL, Peak Temp. - The Moisture Sensitivity Level rating according to the JEDEC industry standard classifications, and peak solder temperature.

(4) There may be additional marking, which relates to the logo, the lot trace code information, or the environmental category on the device.

(5) Multiple Device Markings will be inside parentheses. Only one Device Marking contained in parentheses and separated by a "-" will appear on a device. If a line is indented then it is a continuation of the previous line and the two combined represent the entire Device Marking for that device.

(6) Lead/Ball Finish - Orderable Devices may have multiple material finish options. Finish options are separated by a vertical ruled line. Lead/Ball Finish values may wrap to two lines if the finish value exceeds the maximum column width.

Important Information and Disclaimer:The information provided on this page represents TI's knowledge and belief as of the date that it is provided. TI bases its knowledge and belief on information provided by third parties, and makes no representation or warranty as to the accuracy of such information. Efforts are underway to better integrate information from third parties. TI has taken and continues to take reasonable steps to provide representative and accurate information but may not have conducted destructive testing or chemical analysis on incoming materials and chemicals. TI and TI suppliers consider certain information to be proprietary, and thus CAS numbers and other limited information may not be available for release.

In no event shall TI's liability arising out of such information exceed the total purchase price of the TI part(s) at issue in this document sold by TI to Customer on an annual basis.

TAPE AND REEL INFORMATION

QUADRANT ASSIGNMENTS FOR PIN 1 ORIENTATION IN TAPE

*All dimensions are nominal

Device	Package Type	Package Drawing	Pins	SPQ	Reel Diameter (mm)	Reel Width W1 (mm)	A0 (mm)	B0 (mm)	K0 (mm)	P1 (mm)	W (mm)	Pin1 Quadrant
ADC14DC080CISQE/NOP B	WQFN	NKA	60	250	178.0	16.4	9.3	9.3	1.3	12.0	16.0	Q1

TAPE AND REEL BOX DIMENSIONS

*All dimensions are nominal

Device	Package Type	Package Drawing	Pins	SPQ	Length (mm)	Width (mm)	Height (mm)
ADC14DC080CISQE/NOP B	WQFN	NKA	60	250	210.0	185.0	35.0

NKA0060A

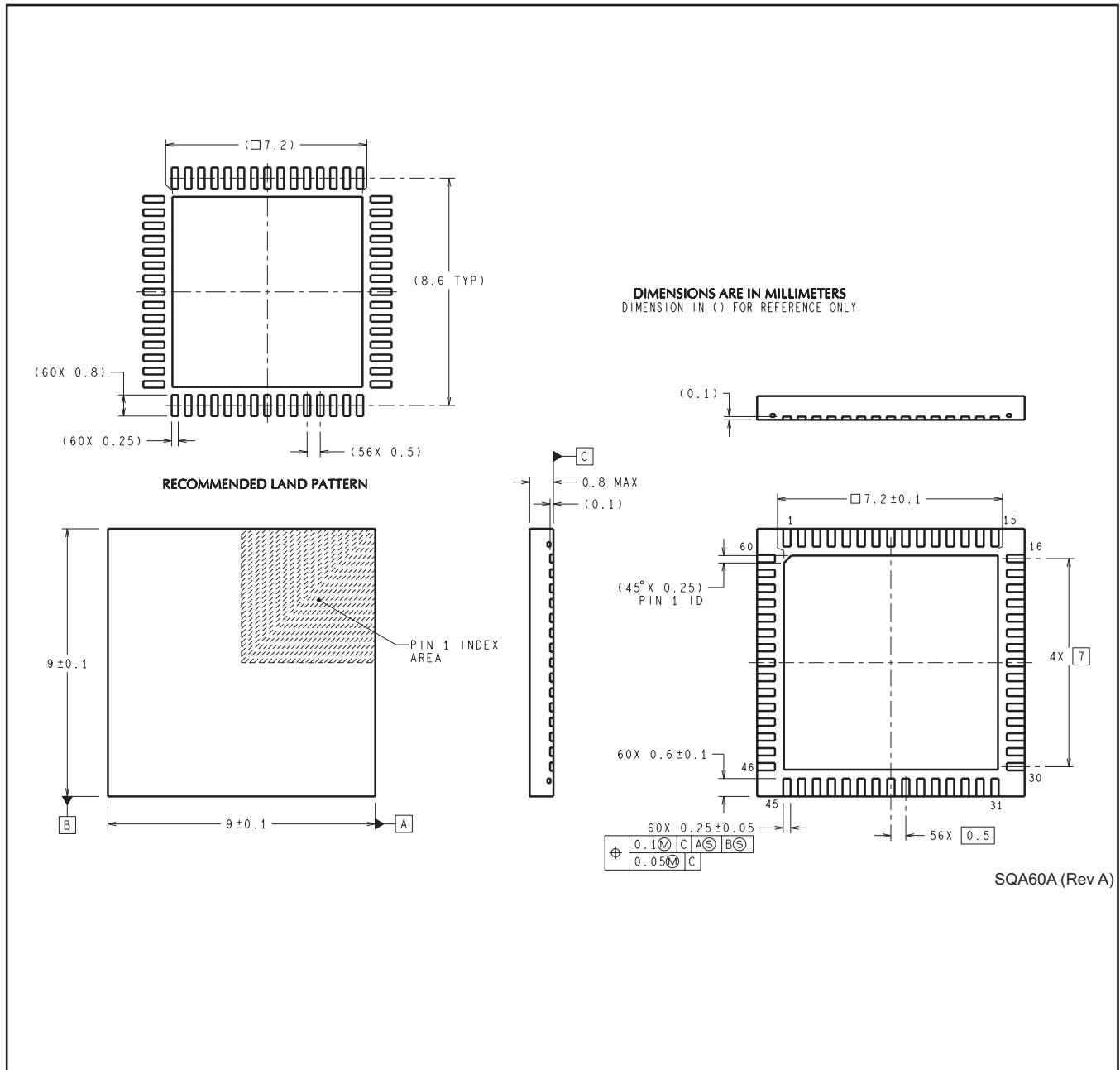

IMPORTANT NOTICE

Texas Instruments Incorporated and its subsidiaries (TI) reserve the right to make corrections, enhancements, improvements and other changes to its semiconductor products and services per JESD46, latest issue, and to discontinue any product or service per JESD48, latest issue. Buyers should obtain the latest relevant information before placing orders and should verify that such information is current and complete. All semiconductor products (also referred to herein as "components") are sold subject to TI's terms and conditions of sale supplied at the time of order acknowledgment.

TI warrants performance of its components to the specifications applicable at the time of sale, in accordance with the warranty in TI's terms and conditions of sale of semiconductor products. Testing and other quality control techniques are used to the extent TI deems necessary to support this warranty. Except where mandated by applicable law, testing of all parameters of each component is not necessarily performed.

TI assumes no liability for applications assistance or the design of Buyers' products. Buyers are responsible for their products and applications using TI components. To minimize the risks associated with Buyers' products and applications, Buyers should provide adequate design and operating safeguards.

TI does not warrant or represent that any license, either express or implied, is granted under any patent right, copyright, mask work right, or other intellectual property right relating to any combination, machine, or process in which TI components or services are used. Information published by TI regarding third-party products or services does not constitute a license to use such products or services or a warranty or endorsement thereof. Use of such information may require a license from a third party under the patents or other intellectual property of the third party, or a license from TI under the patents or other intellectual property of TI.

Reproduction of significant portions of TI information in TI data books or data sheets is permissible only if reproduction is without alteration and is accompanied by all associated warranties, conditions, limitations, and notices. TI is not responsible or liable for such altered documentation. Information of third parties may be subject to additional restrictions.

Resale of TI components or services with statements different from or beyond the parameters stated by TI for that component or service voids all express and any implied warranties for the associated TI component or service and is an unfair and deceptive business practice. TI is not responsible or liable for any such statements.

Buyer acknowledges and agrees that it is solely responsible for compliance with all legal, regulatory and safety-related requirements concerning its products, and any use of TI components in its applications, notwithstanding any applications-related information or support that may be provided by TI. Buyer represents and agrees that it has all the necessary expertise to create and implement safeguards which anticipate dangerous consequences of failures, monitor failures and their consequences, lessen the likelihood of failures that might cause harm and take appropriate remedial actions. Buyer will fully indemnify TI and its representatives against any damages arising out of the use of any TI components in safety-critical applications.

In some cases, TI components may be promoted specifically to facilitate safety-related applications. With such components, TI's goal is to help enable customers to design and create their own end-product solutions that meet applicable functional safety standards and requirements. Nonetheless, such components are subject to these terms.

No TI components are authorized for use in FDA Class III (or similar life-critical medical equipment) unless authorized officers of the parties have executed a special agreement specifically governing such use.

Only those TI components which TI has specifically designated as military grade or "enhanced plastic" are designed and intended for use in military/aerospace applications or environments. Buyer acknowledges and agrees that any military or aerospace use of TI components which have **not** been so designated is solely at the Buyer's risk, and that Buyer is solely responsible for compliance with all legal and regulatory requirements in connection with such use.

TI has specifically designated certain components as meeting ISO/TS16949 requirements, mainly for automotive use. In any case of use of non-designated products, TI will not be responsible for any failure to meet ISO/TS16949.

Products

Audio	www.ti.com/audio
Amplifiers	amplifier.ti.com
Data Converters	dataconverter.ti.com
DLP® Products	www.dlp.com
DSP	dsp.ti.com
Clocks and Timers	www.ti.com/clocks
Interface	interface.ti.com
Logic	logic.ti.com
Power Mgmt	power.ti.com
Microcontrollers	microcontroller.ti.com
RFID	www.ti-rfid.com
OMAP Applications Processors	www.ti.com/omap
Wireless Connectivity	www.ti.com/wirelessconnectivity

Applications

Automotive and Transportation	www.ti.com/automotive
Communications and Telecom	www.ti.com/communications
Computers and Peripherals	www.ti.com/computers
Consumer Electronics	www.ti.com/consumer-apps
Energy and Lighting	www.ti.com/energy
Industrial	www.ti.com/industrial
Medical	www.ti.com/medical
Security	www.ti.com/security
Space, Avionics and Defense	www.ti.com/space-avionics-defense
Video and Imaging	www.ti.com/video

TI E2E Community

e2e.ti.com

Looking for pricing, stock, or lifecycle information?

Click below to explore more details on WIN SOURCE:

- ⊖ [View ADC14DC080CISQE/NOPB on WIN SOURCE](#)
- ⊖ [Texas Instruments](#) Information

Optimize Your Supply Chain with WIN SOURCE Solutions

- ✓ Global Sourcing Solution
- ✓ Obsolete Management
- ✓ Cost Control Management
- ✓ Shortage Management
- ✓ Alternative Solution
- ✓ Excess Inventory Management