



**THE DATASHEET OF  
AD8011AR-REEL7**



### FEATURES

#### Easy to Use

#### Low Power

1 mA Power Supply Current (5 mW on 5 V<sub>S</sub>)

#### High Speed and Fast Settling on 5 V

300 MHz, -3 dB Bandwidth (G = +1)

180 MHz, -3 dB Bandwidth (G = +2)

2000 V/μs Slew Rate

29 ns Settling Time to 0.1%

#### Good Video Specifications (R<sub>L</sub> = 1 kΩ, G = +2)

Gain Flatness 0.1 dB to 25 MHz

0.02% Differential Gain Error

0.06° Differential Phase Error

#### Low Distortion

-70 dBc Worst Harmonic @ 5 MHz

-62 dBc Worst Harmonic @ 20 MHz

#### Single Supply Operation

Fully Specified for 5 V Supply

### APPLICATIONS

Power Sensitive, High Speed Systems

Video Switchers

Distribution Amplifiers

A-to-D Driver

Professional Cameras

CCD Imaging Systems

Ultrasound Equipment (Multichannel)

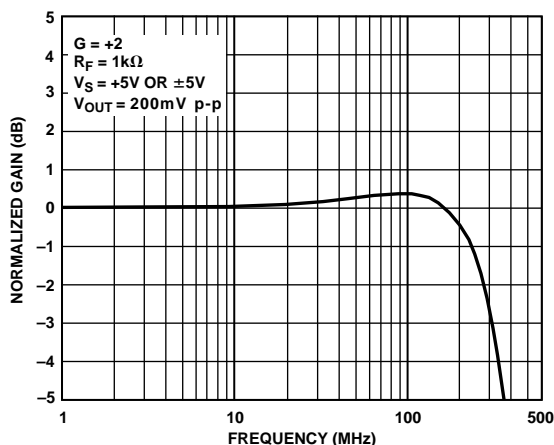

Figure 1. Frequency Response; G = +2, V<sub>S</sub> = +5 V, or ±5 V

REV. C

Information furnished by Analog Devices is believed to be accurate and reliable. However, no responsibility is assumed by Analog Devices for its use, nor for any infringements of patents or other rights of third parties that may result from its use. No license is granted by implication or otherwise under any patent or patent rights of Analog Devices. Trademarks and registered trademarks are the property of their respective companies.

### FUNCTIONAL BLOCK DIAGRAM

#### 8-Lead PDIP and SOIC

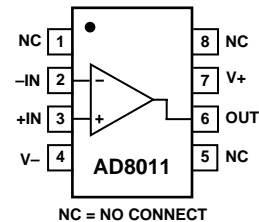

### PRODUCT DESCRIPTION

The AD8011 is a very low power, high speed amplifier designed to operate on +5 V or ±5 V supplies. With wide bandwidth, low distortion, and low power, this device is ideal as a general-purpose amplifier. It also can be used to replace high speed amplifiers consuming more power. The AD8011 is a current feedback amplifier and features gain flatness of 0.1 dB to 25 MHz while offering differential gain and phase error of 0.02% and 0.06° on a single 5 V supply. This makes the AD8011 ideal for professional video electronics such as cameras, video switchers, or any high speed portable equipment. Additionally, the AD8011's low distortion and fast settling make it ideal for buffering high speed 8-, 10-, and 12-bit A-to-D converters.

The AD8011 offers very low power of 1 mA maximum and can run on single 5 V to 12 V supplies. All this is offered in a small 8-lead PDIP or 8-lead SOIC package. These features fit well with portable and battery-powered applications where size and power are critical.

The AD8011 is available in the industrial temperature range of -40°C to +85°C.

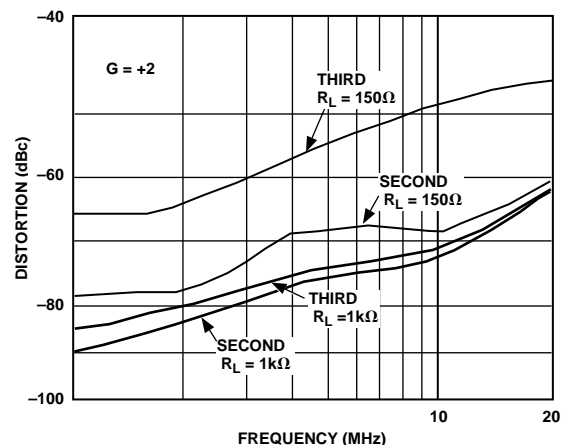

Figure 2. Distortion vs. Frequency; V<sub>S</sub> = ±5 V

# AD8011—SPECIFICATIONS

## DUAL SUPPLY (@ $T_A = 25^\circ\text{C}$ , $V_S = \pm 5\text{ V}$ , $G = +2$ , $R_F = 1\text{ k}\Omega$ , $R_L = 1\text{ k}\Omega$ , unless otherwise noted.)

Parameter	Conditions	AD8011A			Unit
		Min	Typ	Max	
<b>DYNAMIC PERFORMANCE</b>					
-3 dB Small Signal Bandwidth, $V_O < 1\text{ V p-p}$	$G = +1$	340	400		MHz
-3 dB Small Signal Bandwidth, $V_O < 1\text{ V p-p}$	$G = +2$	180	210		MHz
-3 dB Large Signal Bandwidth, $V_O = 5\text{ V p-p}$	$G = +10$ , $R_F = 500\ \Omega$		57		MHz
Bandwidth for 0.1 dB Flatness	$G = +2$	20	25		MHz
Slew Rate	$G = +2$ , $V_O = 4\text{ V Step}$		3500		V/ $\mu\text{s}$
	$G = -1$ , $V_O = 4\text{ V Step}$		1100		V/ $\mu\text{s}$
Settling Time to 0.1%	$G = +2$ , $V_O = 2\text{ V Step}$		25		ns
Rise and Fall Time	$G = +2$ , $V_O = 2\text{ V Step}$		0.4		ns
	$G = -1$ , $V_O = 2\text{ V Step}$		3.7		ns
<b>NOISE/HARMONIC PERFORMANCE</b>					
Second Harmonic	$f_C = 5\text{ MHz}$ , $V_O = 2\text{ V p-p}$ , $G = +2$ $R_L = 1\text{ k}\Omega$		-75		dB
	$R_L = 150\ \Omega$		-67		dB
Third Harmonic	$R_L = 1\text{ k}\Omega$		-70		dB
	$R_L = 150\ \Omega$		-54		dB
Input Voltage Noise	$f = 10\text{ kHz}$		2		nV/ $\sqrt{\text{Hz}}$
Input Current Noise	$f = 10\text{ kHz}$ , +In		5		pA/ $\sqrt{\text{Hz}}$
	-In		5		pA/ $\sqrt{\text{Hz}}$
Differential Gain Error	NTSC, $G = +2$ , $R_L = 1\text{ k}\Omega$		0.02		%
	$R_L = 150\ \Omega$		0.02		%
Differential Phase Error	NTSC, $G = +2$ , $R_L = 1\text{ k}\Omega$		0.06		Degrees
	$R_L = 150\ \Omega$		0.3		Degrees
<b>DC PERFORMANCE</b>					
Input Offset Voltage			2	5	$\pm\text{mV}$
	$T_{\text{MIN}}-T_{\text{MAX}}$		2	6	$\pm\text{mV}$
Offset Drift			10		$\mu\text{V}/^\circ\text{C}$
-Input Bias Current			5	15	$\pm\mu\text{A}$
	$T_{\text{MIN}}-T_{\text{MAX}}$			20	$\pm\mu\text{A}$
+Input Bias Current			5	15	$\pm\mu\text{A}$
	$T_{\text{MIN}}-T_{\text{MAX}}$			20	$\pm\mu\text{A}$
Open-Loop Transresistance		800	1300		k $\Omega$
	$T_{\text{MIN}}-T_{\text{MAX}}$	550			k $\Omega$
<b>INPUT CHARACTERISTICS</b>					
Input Resistance	+Input		450		k $\Omega$
Input Capacitance	+Input		2.3		pF
Input Common-Mode Voltage Range		3.8	4.1		$\pm\text{V}$
Common-Mode Rejection Ratio					dB
Offset Voltage	$V_{\text{CM}} = \pm 2.5\text{ V}$	-52	-57		dB
<b>OUTPUT CHARACTERISTICS</b>					
Output Voltage Swing		3.9	4.1		$\pm\text{V}$
Output Resistance			0.1	0.3	$\Omega$
Output Current	$T_{\text{MIN}}-T_{\text{MAX}}$	15	30		mA
Short-Circuit Current			60		mA
<b>POWER SUPPLY</b>					
Operating Range		$\pm 1.5$		$\pm 6.0$	V
Quiescent Current	$T_{\text{MIN}}-T_{\text{MAX}}$		1.0	1.3	mA
Power Supply Rejection Ratio	$V_S = \pm 5\text{ V} \pm 1\text{ V}$	55	58		dB

Specifications subject to change without notice.

**SINGLE SUPPLY** (@  $T_A = 25^\circ\text{C}$ ,  $V_S = 5\text{ V}$ ,  $G = +2$ ,  $R_F = 1\text{ k}\Omega$ ,  $V_{CM} = 2.5\text{ V}$ ,  $R_L = 1\text{ k}\Omega$ , unless otherwise noted.)

Parameter	Conditions	AD8011A			Unit
		Min	Typ	Max	
<b>DYNAMIC PERFORMANCE</b>					
-3 dB Small Signal Bandwidth, $V_O < 0.5\text{ V p-p}$	$G = +1$	270	328		MHz
-3 dB Small Signal Bandwidth, $V_O < 0.5\text{ V p-p}$	$G = +2$	150	180		MHz
-3 dB Large Signal Bandwidth, $V_O = 2.5\text{ V p-p}$	$G = +10$ , $R_F = 500\ \Omega$		57		MHz
Bandwidth for 0.1 dB Flatness	$G = +2$	15	20		MHz
Slew Rate	$G = +2$ , $V_O = 2\text{ V Step}$		2000		V/ $\mu\text{s}$
	$G = -1$ , $V_O = 2\text{ V Step}$		500		V/ $\mu\text{s}$
Settling Time to 0.1%	$G = +2$ , $V_O = 2\text{ V Step}$		29		ns
Rise and Fall Time	$G = +2$ , $V_O = 2\text{ V Step}$		0.6		ns
	$G = -1$ , $V_O = 2\text{ V Step}$		4		ns
<b>NOISE/HARMONIC PERFORMANCE</b>					
Second Harmonic	$f_C = 5\text{ MHz}$ , $V_O = 2\text{ V p-p}$ , $G = +2$ $R_L = 1\text{ k}\Omega$		-84		dB
	$R_L = 150\ \Omega$		-67		dB
Third Harmonic	$R_L = 1\text{ k}\Omega$		-76		dB
	$R_L = 150\ \Omega$		-54		dB
Input Voltage Noise	$f = 10\text{ kHz}$		2		nV/ $\sqrt{\text{Hz}}$
Input Current Noise	$f = 10\text{ kHz}$ , $+I_{in}$		5		pA/ $\sqrt{\text{Hz}}$
	$-I_{in}$		5		pA/ $\sqrt{\text{Hz}}$
Differential Gain Error	NTSC, $G = +2$ , $R_L = 1\text{ k}\Omega$		0.02		%
	$R_L = 150\ \Omega$		0.6		%
Differential Phase Error	NTSC, $G = +2$ , $R_L = 1\text{ k}\Omega$		0.06		Degrees
	$R_L = 150\ \Omega$		0.8		Degrees
<b>DC PERFORMANCE</b>					
Input Offset Voltage			2	5	mV
	$T_{MIN}-T_{MAX}$		2	6	mV
Offset Drift			10		$\mu\text{V}/^\circ\text{C}$
-Input Bias Current			5	15	$\pm\mu\text{A}$
	$T_{MIN}-T_{MAX}$			20	$\pm\mu\text{A}$
+Input Bias Current			5	15	$\pm\mu\text{A}$
	$T_{MIN}-T_{MAX}$			20	$\pm\mu\text{A}$
Open-Loop Transresistance		800	1300		k $\Omega$
	$T_{MIN}-T_{MAX}$	550			k $\Omega$
<b>INPUT CHARACTERISTICS</b>					
Input Resistance	+Input		450		k $\Omega$
Input Capacitance	+Input		2.3		pF
Input Common-Mode Voltage Range		1.5 to 3.5	1.2 to 3.8		V
Common-Mode Rejection Ratio					dB
Offset Voltage	$V_{CM} = 1.5\text{ V to }3.5\text{ V}$	-52	-57		dB
<b>OUTPUT CHARACTERISTICS</b>					
Output Voltage Swing		1.2 to 3.8	0.9 to 4.1		+V
Output Resistance			0.1	0.3	$\Omega$
Output Current	$T_{MIN}-T_{MAX}$	15	30		mA
Short-Circuit Current			50		mA
<b>POWER SUPPLY</b>					
Operating Range		+3		+12	V
Quiescent Current	$T_{MIN}-T_{MAX}$		0.8	1.15	mA
Power Supply Rejection Ratio	$\Delta V_S = \pm 1\text{ V}$	55	58		dB

Specifications subject to change without notice.

# AD8011

## ABSOLUTE MAXIMUM RATINGS<sup>1</sup>

Supply Voltage	12.6 V
Internal Power Dissipation <sup>2</sup>	
Plastic DIP Package (N)	Observe Derating Curves
Small Outline Package (R)	Observe Derating Curves
Input Voltage (Common Mode)	$\pm V_S$
Differential Input Voltage	$\pm 2.5$ V
Output Short-Circuit Duration	
Observe Power Derating Curves	
Storage Temperature Range (N, R)	$-65^{\circ}\text{C}$ to $+125^{\circ}\text{C}$
Operating Temperature Range (A Grade)	$-40^{\circ}\text{C}$ to $+85^{\circ}\text{C}$
Lead Temperature Range (Soldering 10 sec)	$300^{\circ}\text{C}$

## NOTES

<sup>1</sup> Stresses above those listed under Absolute Maximum Ratings may cause permanent damage to the device. This is a stress rating only; functional operation of the device at these or any other conditions above those indicated in the operational section of this specification is not implied. Exposure to absolute maximum rating conditions for extended periods may affect device reliability.

<sup>2</sup> Specification is for device in free air:

8-Lead PDIP Package:  $\theta_{JA} = 90^{\circ}\text{C}/\text{W}$

8-Lead SOIC Package:  $\theta_{JA} = 155^{\circ}\text{C}/\text{W}$

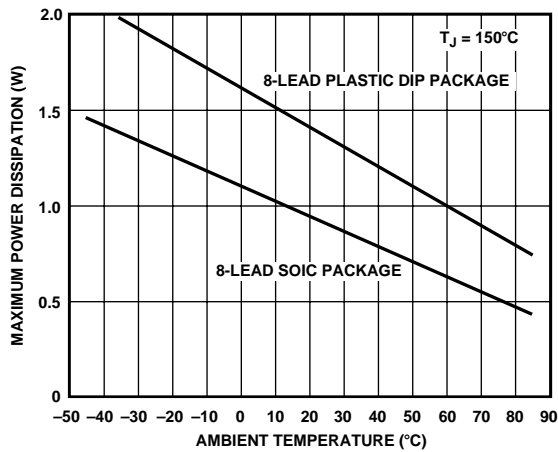

Figure 3. Maximum Power Dissipation vs. Temperature

## MAXIMUM POWER DISSIPATION

The maximum power that can be safely dissipated by the AD8011 is limited by the associated rise in junction temperature. The maximum safe junction temperature for plastic encapsulated devices is determined by the glass transition temperature of the plastic, approximately  $150^{\circ}\text{C}$ . Exceeding this limit temporarily may cause a shift in parametric performance due to a change in the stresses exerted on the die by the package. Exceeding a junction temperature of  $175^{\circ}\text{C}$  for an extended period can result in device failure.

While the AD8011 is internally short-circuit protected, this may not be sufficient to guarantee that the maximum junction temperature is not exceeded under all conditions. To ensure proper operation, it is necessary to observe the maximum power derating curves (shown in Figure 3).

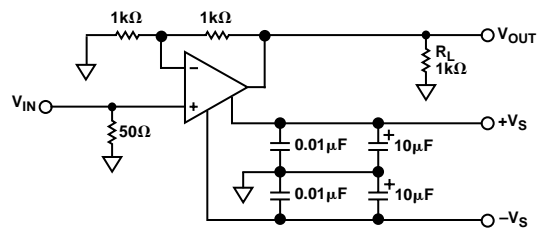

Figure 4. Test Circuit; Gain = +2

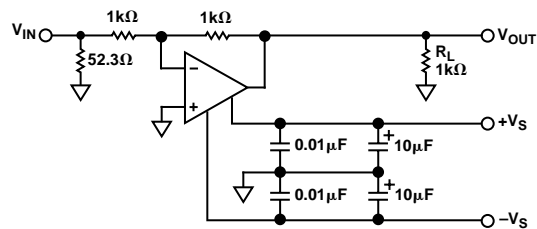

Figure 5. Test Circuit; Gain = -1

## ORDERING GUIDE

Model	Temperature Range	Package Description	Package Option
AD8011AN	$-40^{\circ}\text{C}$ to $+85^{\circ}\text{C}$	8-Lead PDIP	N-8
AD8011AR	$-40^{\circ}\text{C}$ to $+85^{\circ}\text{C}$	8-Lead SOIC	R-8
AD8011AR-REEL	$-40^{\circ}\text{C}$ to $+85^{\circ}\text{C}$	13" Tape and Reel	R-8
AD8011AR-REEL7	$-40^{\circ}\text{C}$ to $+85^{\circ}\text{C}$	7" Tape and Reel	R-8

## CAUTION

ESD (electrostatic discharge) sensitive device. Electrostatic charges as high as 4000 V readily accumulate on the human body and test equipment and can discharge without detection. Although the AD8011 features proprietary ESD protection circuitry, permanent damage may occur on devices subjected to high energy electrostatic discharges. Therefore, proper ESD precautions are recommended to avoid performance degradation or loss of functionality.



# Typical Performance Characteristics—AD8011

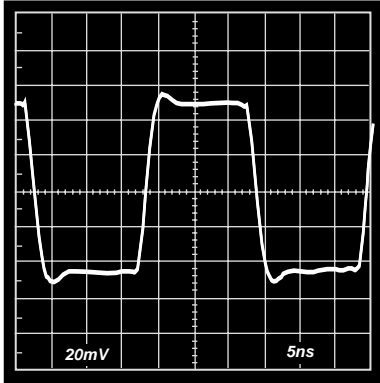

\*TPC 1. 100 mV Step Response;  $G = +2$ ,  $V_S = \pm 2.5 \text{ V}$  or  $\pm 5 \text{ V}$

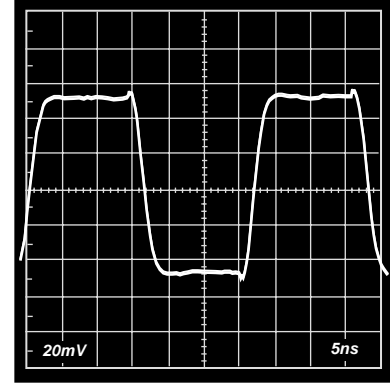

\*TPC 4. 100 mV Step Response;  $G = -1$ ,  $V_S = \pm 2.5 \text{ V}$  or  $\pm 5 \text{ V}$

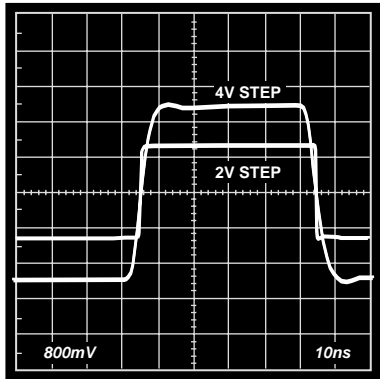

\*TPC 2. Step Response;  $G = +2$ ,  $V_S = \pm 2.5 \text{ V}$  (2 V Step) and  $\pm 5 \text{ V}$  (4 V Step)

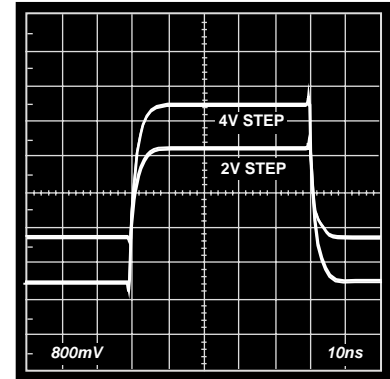

\*TPC 5. Step Response;  $G = -1$ ,  $V_S = \pm 2.5 \text{ V}$  (2 V Step) and  $\pm 5 \text{ V}$  (4 V Step)

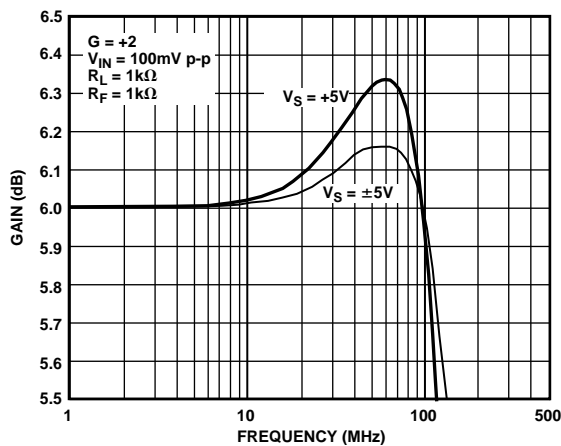

TPC 3. Gain Flatness;  $G = +2$

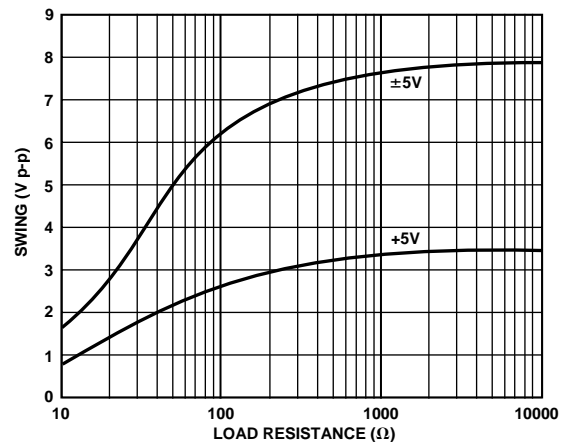

TPC 6. Output Voltage Swing vs. Load

\*NOTE:  $V_S = \pm 5 \text{ V}$  operation is identical to  $V_S = +5 \text{ V}$  single-supply operation.

# AD8011

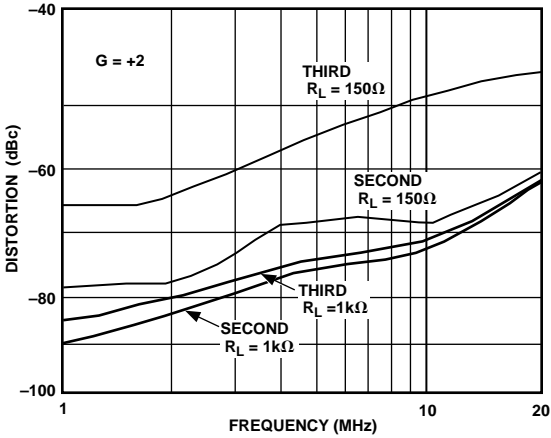

TPC 7. Distortion vs. Frequency;  $V_S = \pm 5 V$

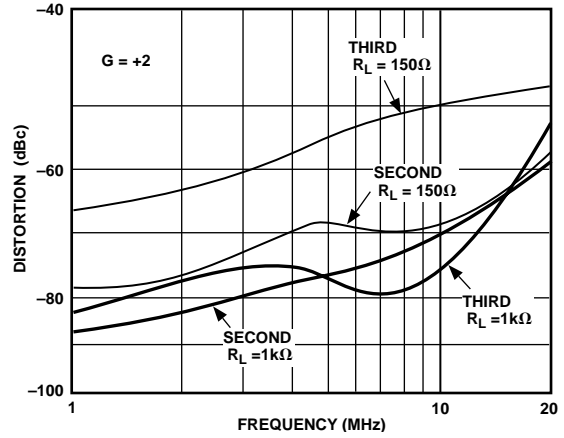

TPC 10. Distortion vs. Frequency;  $V_S = +5 V$

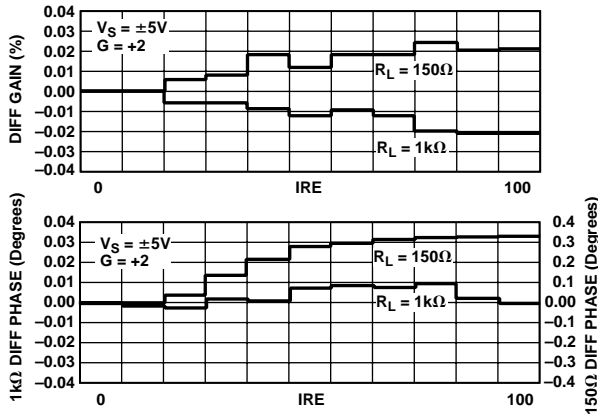

TPC 8. Diff Phase and Diff Gain;  $V_S = \pm 5 V$

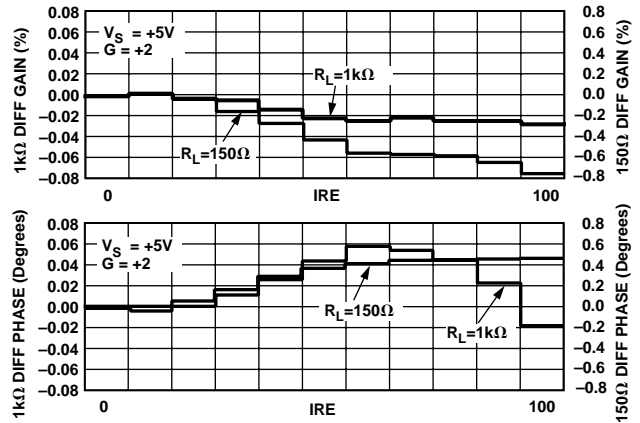

TPC 11. Diff Phase and Diff Gain;  $V_S = +5 V$

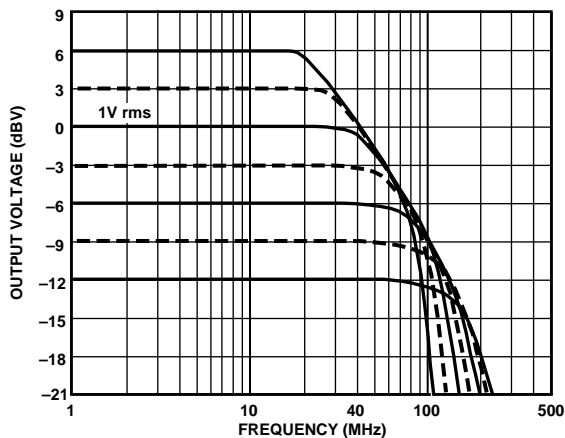

TPC 9. Large Signal Frequency Response;  $V_S = \pm 5 V, G = +2$

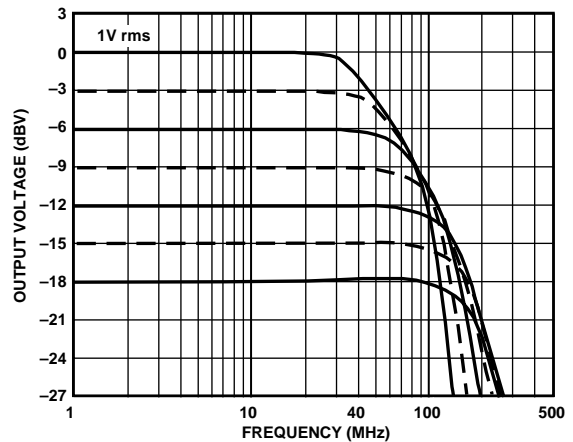

TPC 12. Large Signal Frequency Response;  $V_S = +5 V, G = +2$

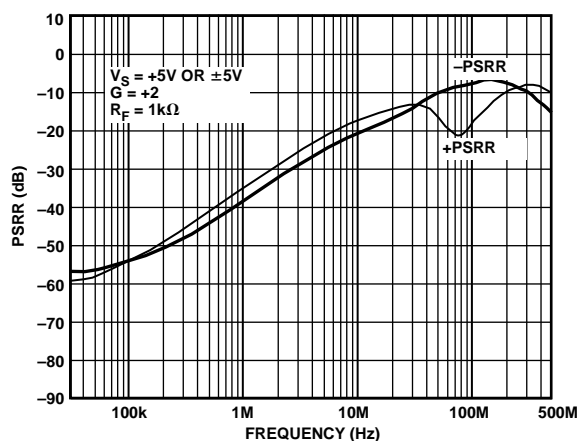
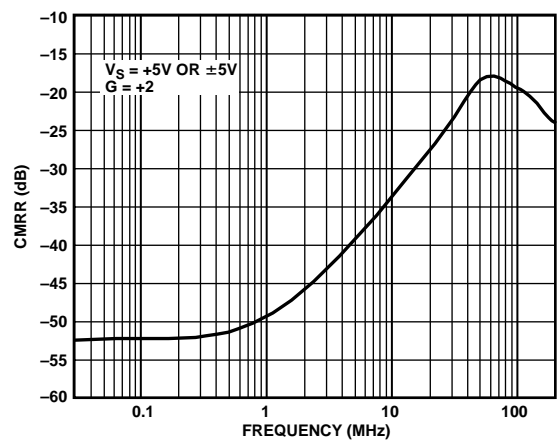
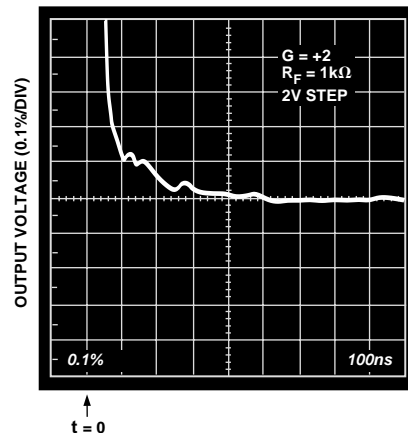
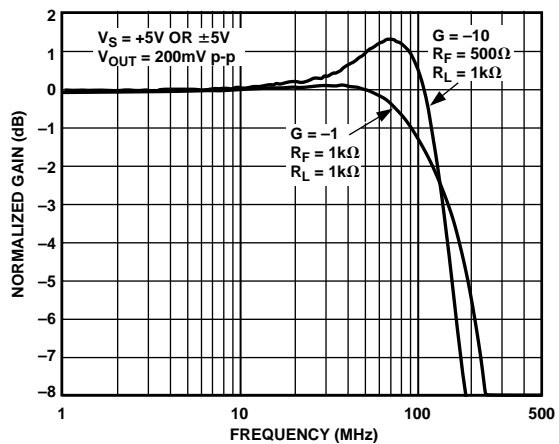
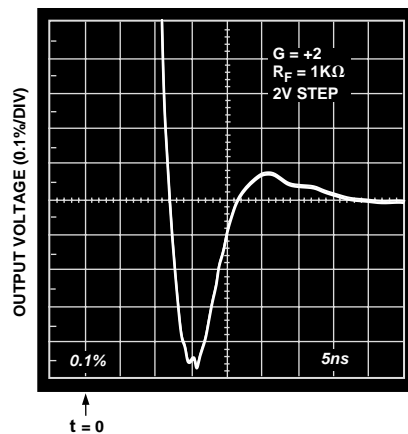
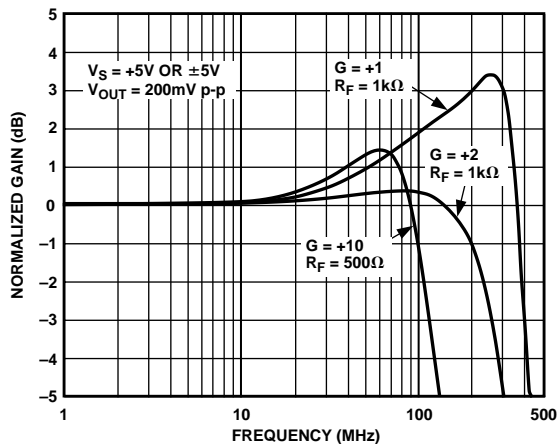

# AD8011

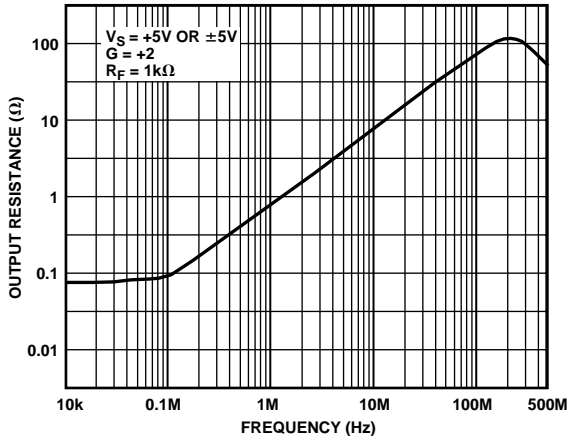

TPC 19. Output Resistance vs. Frequency;  
 $V_S = +5 V$  or  $\pm 5 V$

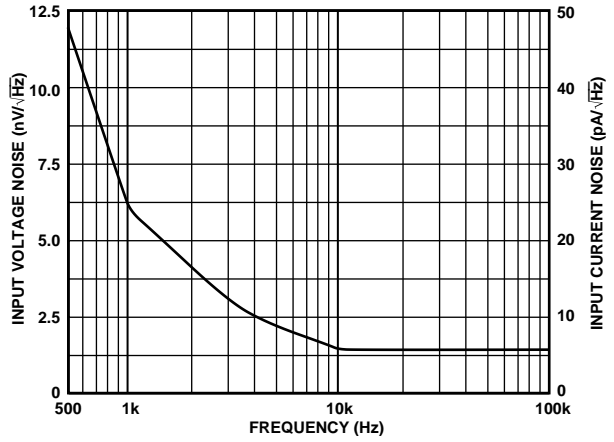

TPC 21. Noise vs. Frequency;  $V_S = +5 V$  or  $\pm 5 V$

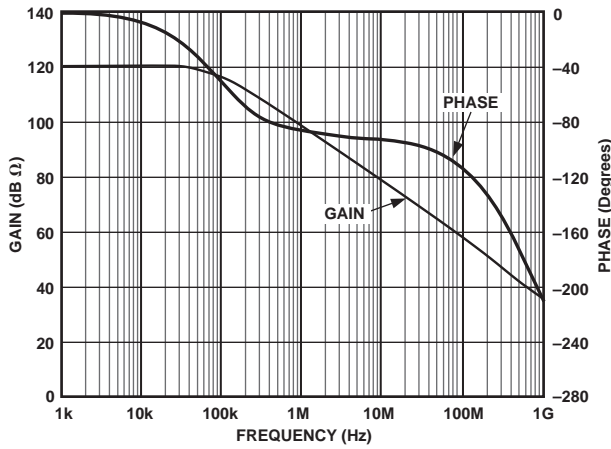

TPC 20. Transimpedance Gain and Phase vs. Frequency

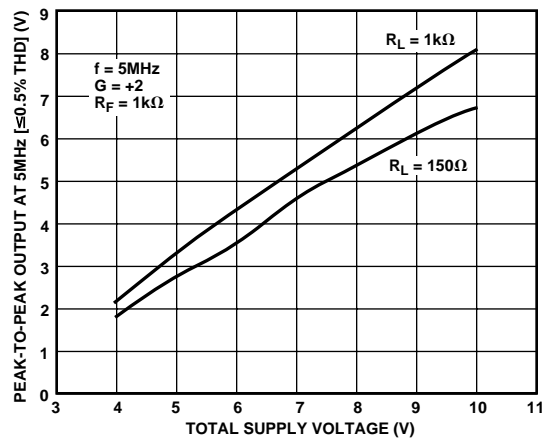

TPC 22. Output Swing vs. Supply



# AD8011

(error current times the open-loop inverting input resistance) that results (see Figure 7), a more exact low frequency closed-loop transfer function can be described as

$$A_V = \frac{G}{1 + \frac{G \times R_I}{T_O} + \frac{R_F}{T_O}} = \frac{G}{1 + \frac{G}{A_O} + \frac{R_F}{T_O}}$$

for noninverting ( $G$  is positive).

$$A_V = \frac{G}{1 + \frac{1-G}{A_O} + \frac{R_F}{T_O}}$$

for inverting ( $G$  is negative).

where  $G$  is the ideal gain as previously described. With  $R_I = T_O/A_O$  (open-loop inverting input resistance), the second expression (positive  $G$ ) clearly relates to the classical voltage feedback *op amp* equation with  $T_O$  omitted due to its relatively much higher value and thus insignificant effect.  $A_O$  and  $T_O$  are the open-loop dc voltage and transresistance gains of the amplifier, respectively. These key transfer variables can be described as

$$A_O = \frac{R1 \times g_{mf} \times |A2|}{(1 - g_{mc} \times R1)}$$

and

$$T_O = \frac{R1 \times |A2|}{2}$$

$$R1 = \frac{1 - g_{mc} \times R1}{2 \times g_{mf}}$$

Therefore

where  $g_{mc}$  is the positive feedback transconductance (not shown) and  $1/g_{mf}$  is the thermal emitter resistance of devices D1/D2 and Q3/Q4. The  $g_{mc} \times R1$  product has a design value that results in a negative dc open-loop gain of typically  $-2500$  V/V (see Figure 8).

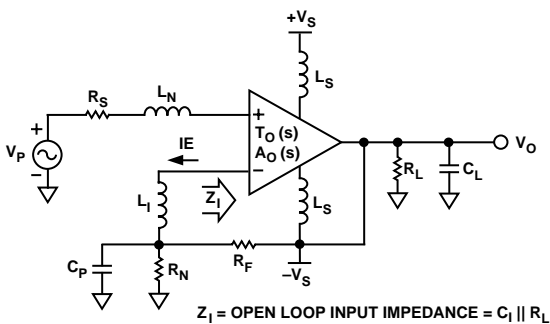

Figure 7.  $Z_I =$  Open-Loop Input Impedance

Though atypical of conventional CF or VF amps, this negative open-loop voltage gain results in an input referred error term ( $V_P - V_O/G = G/A_O + R_F/T_O$ ) that will typically be negative for  $G$ , greater than  $+3/-4$ . As an example, for  $G = 10$ ,  $A_O = -2500$ , and  $T_O = 1.2$  M $\Omega$ , results in an error of  $-3$  mV using the  $A_V$  derivation above.

This analysis assumes perfect current sources and infinite transistor  $V_{AS}$ . (Q3, Q4 output conductances are assumed zero.) These assumptions result in actual versus model open-loop voltage gain and associated input referred error terms being less accurate for low gain ( $G$ ) noninverting operation at the frequencies below the open-loop pole of the AD8011. This is primarily a result of the input signal ( $V_P$ ) modulating the output conductances of Q3/Q4, resulting in  $R_I$  less negative than derived here. For inverting operation, the actual versus model dc error terms are relatively much less.

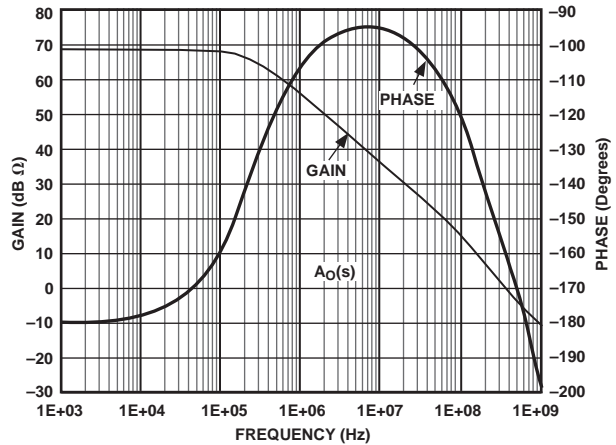

Figure 8. Open-Loop Voltage Gain and Phase

## AC TRANSFER CHARACTERISTICS

The ac small signal transfer derivations below are based on a simplified single-pole model. Though inaccurate at frequencies approaching the closed-loop BW (CLBW) of the AD8011 at low noninverting external gains, they still provide a fair approximation and an intuitive understanding of its primary ac small signal characteristics.

For inverting operation and high noninverting gains, these transfer equations provide a good approximation to the actual ac performance of the device.

To accurately quantify the  $V_O$  versus  $V_P$  relationship,  $A_O(s)$  and  $T_O(s)$  need to be derived. This can be seen by the following nonexpanded noninverting gain relationship

$$V_O(s) / V_P(s) = \frac{G}{\frac{G}{A_O[s]} + \frac{R_F}{T_O[s]} + 1}$$

with

$$A_O(s) = \frac{R1 \times g_{mf} \times |A2|}{\frac{1 - g_{mc} \times R1}{S\tau1} + 1 - g_{mc} \times R1}$$

where  $R1$  is the input resistance to A2/A2B, and  $\tau1$  (equal to  $CD \times R1 \times A2$ ) is the open-loop dominate time constant,

$$\text{and } T_O(s) = \frac{|A2| \times R1}{\frac{2}{s\tau1} + 1}$$

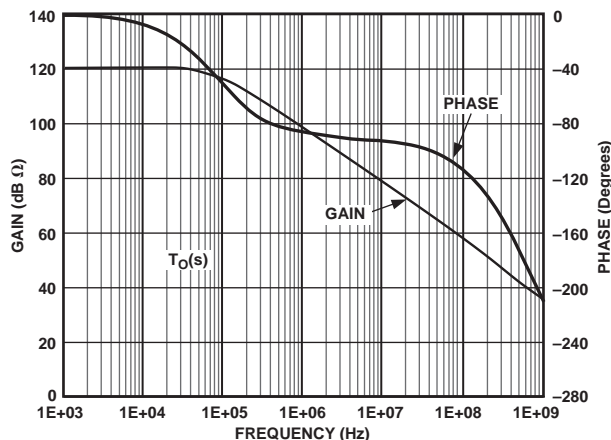

Figure 9. Open-Loop Transimpedance Gain

Note that the ac open-loop plots in Figures 8, 9, and 10 are based on the full SPICE AD8011 simulations and do not include external parasitics (see equations below). Nevertheless, these ac loop equations still provide a good approximation to simulated and actual performance up to the CLBW of the amplifier. Typically,  $g_{mc} \times R_1$  is  $-4$ , resulting in  $A_O(s)$  having a right half plane pole. In the time domain (inverse Laplace of  $A_O$ ), it appears as unstable, causing  $V_O$  to exponentially rail out of its linear region. When the loop is closed however, the BW is greatly extended and the transimpedance gain,  $T_O(s)$ , overrides and directly controls the amplifiers stability behavior due to  $Z_I$  approaching  $1/2 g_{mf}$  for  $s \gg 1/\tau_1$  (see Figure 10). This can be seen by the  $Z_I(s)$  and  $A_V(s)$  noninverting transfer equations below.

$$Z_I(s) = \frac{(1 - g_{mc} \times R_1) \left[ \frac{S\tau_1}{1 - g_{mc} \times R_1} + 1 \right]}{2 \times g_{mf} (S\tau_1 + 1)}$$

$$A_V(s) = \frac{G}{\left[ 1 + \frac{G}{A_O} + \frac{R_F}{T_O} \right] \left[ S\tau_1 \left( \frac{G}{2 g_{mf} T_O} + \frac{R_F}{T_O} \right) + 1 \right]}$$

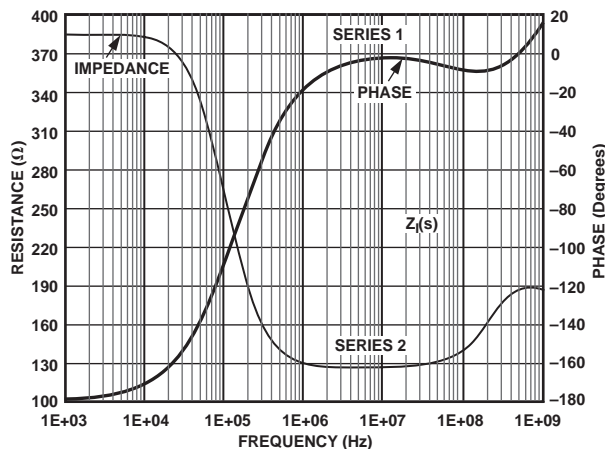

Figure 10. Open-Loop Inverting Input Impedance

$Z_I(s)$  goes positive real and approaches  $1/2 g_{mf}$  as  $\omega$  approaches  $(g_{mc} | R_1 - 1)/\tau_1$ . This results in the input resistance for the  $A_V(s)$  complex term being  $1/2 g_{mf}$ , the parallel thermal emitter resistances of  $Q3/Q4$ . Using the computed CLBW from  $A_V(s)$  and the nominal design values for the other parameters, results in a closed-loop 3 dB BW equal to the open-loop corner frequency  $(1/2 \pi\tau_1) \times 1/[G/(2 g_{mf} \times T_O) + R_F/T_O]$ . For a fixed  $R_F$ , the 3 dB BW is controlled by the  $R_F/T_O$  term for low gains and  $G/(2 g_{mf} \times T_O)$  for high gains. For example, using nominal design parameters and  $R_1 = 1 \text{ k}\Omega$  (which results in a nominal  $T_O$  of  $1.2 \text{ M}\Omega$ ), the computed BW is 80 MHz for  $G = 0$  (inverting I-V mode with  $R_N$  removed) and 40 MHz for  $G = +10/-9$ .

**DRIVING CAPACITIVE LOADS**

The AD8011 was designed primarily to drive nonreactive loads. If driving loads with a capacitive component is desired, the best settling response is obtained by the addition of a small series resistance as shown in Figure 11. The accompanying graph shows the optimum value for  $R_{SERIES}$  versus capacitive load. It is worth noting that the frequency response of the circuit when driving large capacitive loads will be dominated by the passive roll-off of  $R_{SERIES}$  and  $C_L$ .

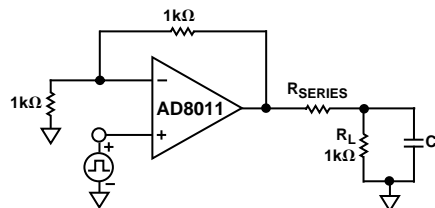

Figure 11. Driving Capacitive Load

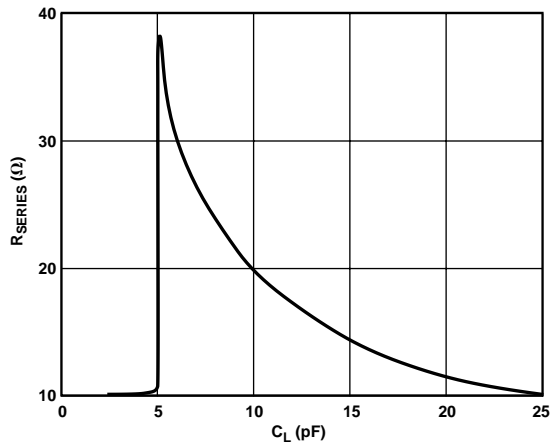

Figure 12. Recommended  $R_{SERIES}$  vs. Capacitive Load for  $\leq 30$  ns Settling to 0.1%

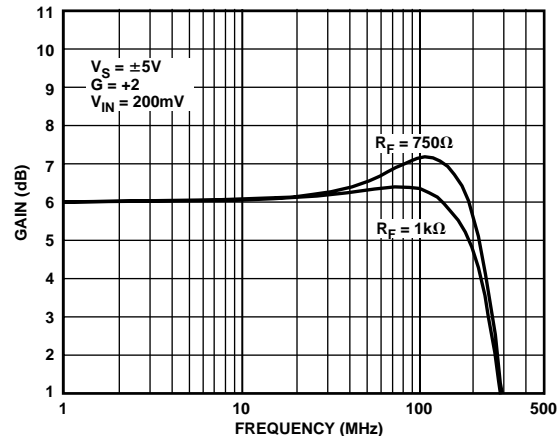

Figure 13. Flatness vs. Feedback

### OPTIMIZING FLATNESS

As mentioned, the previous ac transfer equations are based on a simplified single-pole model. Due to the device's internal parasitics (primarily  $C_{P1}/C_{P1B}$  and  $C_{P2}$  in Figure 6) and external package/board parasitics (partially represented in Figure 12) the computed BW, using the previous  $V_O(s)$  equation, typically will be lower than the AD8011's measured small signal BW. See data sheet Bode plots.

With only internal parasitics included, the BW is extended due to the complex pole pairs created primarily by  $C_{P1}/C_{P2B}$  and  $C_{P2}$  versus the single-pole assumption shown above. This results in a *design controlled*, closed-loop damping factor ( $\zeta$ ) of nominally 0.6 resulting in the CLBW increasing by approximately  $1.3\times$  higher than the computed single-pole value above for optimized external gains of  $+2/-1$ . As external noninverting gain ( $G$ ) is increased, the actual closed-loop bandwidth versus the computed single-pole ac response is in closer agreement.

Inverting pin and external component capacitance (designated  $C_P$ ) will further extend the CLBW due to the closed-loop zero created by  $C_P$  and  $R_N \parallel R_F$  when operating in the noninverting mode. Using proper  $R_F$  component and layout techniques (see the Layout Considerations section), this capacitance should be about 1.5 pF. This results in a further incremental BW increase of almost  $2\times$  (versus the computed value) for  $G = +1$  decreasing and approaching its complex pole pair BW for gains approaching  $+6$  or higher. As previously discussed, the single-pole response begins to correlate well. Note that a pole is also created by  $1/2 g_{mf}$  and  $C_P$ , which prevents the AD8011 from becoming unstable. This parasitic has the greatest effect on BW and peaking for low positive gains as the data sheet Bode plots clearly show. For inverting operation,  $C_P$  has relatively much less effect on CLBW variation.

Output pin and external component capacitance (designated  $C_L$ ) will further extend the device's BW and can also cause peaking below and above the CLBW if too high. In the time domain, poor step settling characteristics (ringing up to about 2 GHz and excessive overshoot) can result. For high  $C_L$  values greater than about 5 pF, an external series *damping* resistor is recommended. For light loads, any output capacitance will reflect on A2's output ( $Z_2$  of buffer A3) as both added capacitance near the CLBW ( $CLBW > f_T/B$ ) and eventually negative resistance at much higher frequencies. These added effects are proportional to the load  $C$ . This reflected capacitance and negative resistance has the effect of both reducing A2's phase margin and causing high frequency,  $L \times C$ , peaking respectively. Using an external series resistor (as previously specified) reduces these unwanted effects by creating a reflected zero to A2's output, which will reduce the peaking and eliminate ringing. For heavy resistive loads, relatively more load  $C$  would be required to cause these same effects.

High inductive parasitics, especially on the supplies and inverting/noninverting inputs, can cause modulated low level  $R_F$  ringing on the output in the transient domain. Proper  $R_F$  component and board layout practices need to be observed. Relatively high parasitic lead inductance (roughly  $L > 15$  nh) can result in  $L \times C$  underdamped ringing. Here  $L/C$  means all associated input pins, external components, and lead frame strays, including collector to substrate device capacitance. In the ac domain, this  $L \times C$  resonance effect would typically not appear in the pass band of the amplifier but would appear in the open-loop response at frequencies well above the CLBW of the amplifier.

### INCREASING BW AT HIGH GAINS

As presented previously, for a fixed  $R_F$  (feedback gain setting resistor), the AD8011 CLBW will decrease as  $R_N$  is reduced (increased  $G$ ). This effect can be minimized by simply reducing  $R_F$  and partially restoring the devices optimized BW for gains greater than  $+2/-1$ . Note that the AD8011 is ac optimized (high BW and low peaking) for  $A_V = +2/-1$  and  $R_F = 1\text{ k}\Omega$ . Using this optimized  $G$  as a reference and the previous  $V_O(s)$  equations, the following relationships result:  $R_F = 1\text{ k}\Omega + 2 - G/2\text{ gm}$  for  $G = 1 + R_F/R_N$  (noninverting) or  $R_F = 1\text{ k}\Omega + G + 1/2\text{ gm}$  for  $G = -R_F/R_N$  (inverting).

Using  $1/2\text{ gm}$  equal to  $120\ \Omega$  results in a  $R_F$  of  $500\ \Omega$  for  $G = +5/-4$  and a corresponding  $R_N$  of  $125\ \Omega$ . This will extend the AD8011's BW to near its optimum design value of typically  $180\text{ MHz}$  at  $R_L = 1\text{ k}\Omega$ . In general, for gains greater than  $+7/-6$ ,  $R_F$  should not be reduced to values much below  $400\ \Omega$  or else ac peaking can result. Using this  $R_F$  value as the lower limit will result in BW restoration near its optimized value to the upper  $G$  values specified. Gains greater than about  $+7/-6$  will result in CLBW reduction. The derivations above are just approximations.

### DRIVING A SINGLE-SUPPLY A/D CONVERTER

New CMOS A/D converters are placing greater demands on the amplifiers that drive them. Higher resolutions, faster conversion rates, and input switching irregularities require superior settling characteristics. In addition, these devices run off a single 5 V supply and consume little power, so good single-supply operation with low power consumption are very important. The AD8011 is well positioned for driving this new class of A/D converters.

Figure 14 shows a circuit that uses an AD8011 to drive an AD876, a single-supply, 10-bit, 20 MSPS A/D converter that requires only  $140\text{ mW}$ . Using the AD8011 for level shifting and driving, the A/D exhibits no degradation in performance compared to when it is driven from a signal generator.

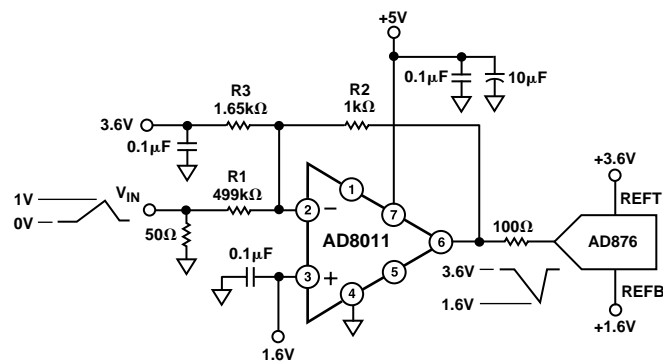

Figure 14. AD8011 Driving the AD876

The analog input of the AD876 spans  $2\text{ V}$  centered at about  $2.6\text{ V}$ . The resistor network and bias voltages provide the level shifting and gain required to convert the  $0\text{ V}$  to  $1\text{ V}$  input signal to a  $3.6\text{ V}$  to  $1.6\text{ V}$  range that the AD876 wants to see.

Biasing the noninverting input of the AD8011 at  $1.6\text{ V}$  dc forces the inverting input to be at  $1.6\text{ V}$  dc for linear operation of the amplifier. When the input is at  $0\text{ V}$ , there is  $3.2\text{ mA}$  flowing out of the summing junction via  $R1$  ( $1.6\text{ V}/499\ \Omega$ ).  $R3$  has a current of  $1.2\text{ mA}$  flowing into the summing junction ( $(3.6\text{ V} - 1.6\text{ V})/1.65\text{ k}\Omega$ ). The difference of these two currents ( $2\text{ mA}$ ) must flow through  $R2$ . This current flows toward the summing junction and requires that the output be  $2\text{ V}$  higher than the summing junction or at  $3.6\text{ V}$ .

When the input is at  $1\text{ V}$ , there is  $1.2\text{ mA}$  flowing into the summing junction through  $R3$  and  $1.2\text{ mA}$  flowing out through  $R1$ . These currents balance and leave no current to flow through  $R2$ . Thus, the output is at the same potential as the inverting input or  $1.6\text{ V}$ .

The input of the AD876 has a series MOSFET switch that turns on and off at the sampling rate. This MOSFET is connected to a hold capacitor, internal to the device. The on impedance of the MOSFET is about  $50\ \Omega$ , while the hold capacitor is about  $5\text{ pF}$ .

In a worst-case condition, the input voltage to the AD876 will change by a full-scale value ( $2\text{ V}$ ) in one sampling cycle. When the input MOSFET turns on, the output of the op amp will be connected to the charged hold capacitor through the series resistance of the MOSFET. Without any other series resistance, the instantaneous current that flows would be  $40\text{ mA}$ . This would cause settling problems for the op amp.

The series  $100\ \Omega$  resistor limits the current that flows instantaneously to about  $13\text{ mA}$  after the MOSFET turns on. This resistor cannot be made too large or the high frequency performance will be affected.

The sampling MOSFET of the AD876 is closed for only half of each cycle or for  $25\text{ ns}$ . Approximately seven time constants are required for settling to 10 bits. The series  $100\ \Omega$  resistor, the  $50\ \Omega$  on resistance, and the hold capacitor create a  $750\text{ ps}$  time constant. These values leave a comfortable margin for settling. Obtaining the same results with the op amp A/D combination as compared to driving with a signal generator indicates that the op amp is settling fast enough.

Overall, the AD8011 provides adequate buffering for the AD876 A/D converter without introducing distortion greater than that of the A/D converter by itself.

# AD8011

## LAYOUT CONSIDERATIONS

The specified high speed performance of the AD8011 requires careful attention to board layout and component selection. Table I shows the recommended component values for the AD8011. Proper  $R_F$  design techniques and low parasitic component selection are mandatory.

**Table I. Typical Bandwidth vs. Gain Setting Resistors**

Gain	$R_F$ ( $\Omega$ )	$R_G$ ( $\Omega$ )	$R_T$ ( $\Omega$ )	Small Signal -3 dB BW (MHz), $V_S = \pm 5$ V
-1	1000	1000	52.3	150
-2	1000	499	54.9	130
-10	499	49.9		140
+1	1000		49.9	400
+2	1000	1000	49.9	250
+10	422	47.5	49.9	100
+6	1000	200	49.9	70
+6	500	100	49.9	170

$R_T$  chosen for 50  $\Omega$  characteristic input impedance.  $R_O$  chosen for characteristic output impedance.

The PCB should have a ground plane covering all unused portions of the component side of the board to provide a low impedance ground path. The ground plane should be removed from the area near the input pins to reduce stray capacitance.

Chip capacitors should be used for supply bypassing (see Figure 15). One end should be connected to the ground plane and the other within 1/8 in. of each power pin. An additional tantalum electrolytic capacitor (4.7  $\mu\text{F}$  – 10  $\mu\text{F}$ ) should be connected in parallel.

The feedback resistor should be located close to the inverting input pin in order to keep the stray capacitance at this node to a minimum. Capacitance greater than 1.5 pF at the inverting input will significantly affect high speed performance when operating at low noninverting gains.

Stripline design techniques should be used for long signal traces (greater than about 1 in.). These should be designed with the proper system characteristic impedance and be properly terminated at each end.

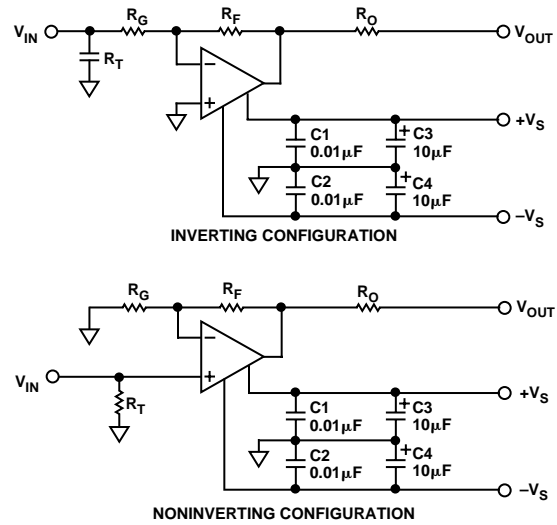
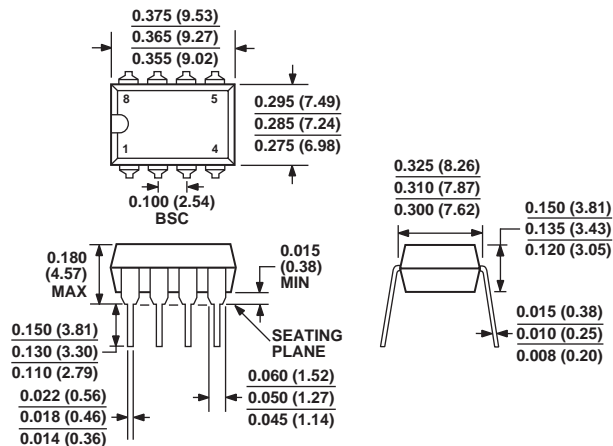

**Figure 15. Inverting and Noninverting Configurations**

OUTLINE DIMENSIONS

8-Lead Plastic Dual In-Line Package [PDIP]  
(N-8)

Dimensions shown in inches and (millimeters)



COMPLIANT TO JEDEC STANDARDS MO-095AA  
CONTROLLING DIMENSIONS ARE IN INCHES; MILLIMETER DIMENSIONS (IN PARENTHESES) ARE ROUNDED-OFF INCH EQUIVALENTS FOR REFERENCE ONLY AND ARE NOT APPROPRIATE FOR USE IN DESIGN

8-Lead Standard Small Outline Package [SOIC]  
(R-8)

Dimensions shown in millimeters and (inches)

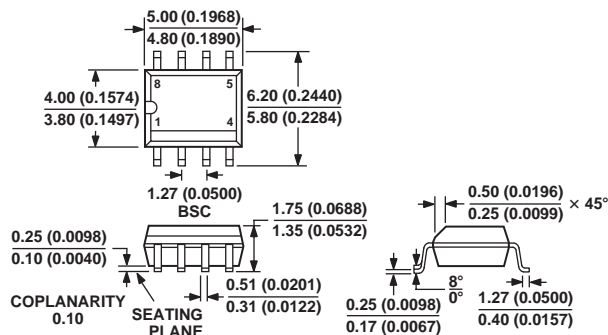

COMPLIANT TO JEDEC STANDARDS MS-012AA  
CONTROLLING DIMENSIONS ARE IN MILLIMETERS; INCH DIMENSIONS (IN PARENTHESES) ARE ROUNDED-OFF MILLIMETER EQUIVALENTS FOR REFERENCE ONLY AND ARE NOT APPROPRIATE FOR USE IN DESIGN

# AD8011

## Revision History

<b>Location</b>	<b>Page</b>
<b>7/03—Data Sheet changed from REV. B to REV. C.</b>	
Deleted all references to evaluation board	Universal
Format updated	Universal
Renumbered figures	Universal
Changes to Figure 1	1
Updated ORDERING GUIDE	4
Changes to TPC 9 and 12	6
Changes to TPC 13 and 14	7
Changes to TPC 21	8
Updated OUTLINE DIMENSIONS	16

C01048-0-7/03(C)

## Looking for pricing, stock, or lifecycle information?

Click below to explore more details on WIN SOURCE:

 [View AD8011AR-REEL7 on WIN SOURCE](#)

 [Analog Devices Inc. Information](#)

## Optimize Your Supply Chain with WIN SOURCE Solutions

-  Global Sourcing Solution
-  Obsolete Management
-  Cost Control Management
-  Shortage Management
-  Alternative Solution
-  Excess Inventory Management