



**THE DATASHEET OF
ABM8G-25.000MHZ-18-D2Y-T**



ULTRA MINIATURE CERAMIC GLASS SEALED SMD CRYSTAL



3.2 x 2.5 x 1.0mm

ABM8G

Pb in glass exemption 7 (c)-I per
RoHS II 2011/65/EU Annex

RoHS/RoHS II Compliant

Moisture Sensitivity Level (MSL) – This product is Hermetically Sealed and not Moisture Sensitive - MSL = N/A: Not Applicable

➤ **FEATURES:**

- Low in height; suitable for thin equipment
- Glass sealed package assures high reliability and high temperature operation
- Tight tolerance and stability available
- IR reflow capable
- Low cost version of ABM8 crystal

➤ **APPLICATIONS:**

- High density applications.
- Modems, communication and test equipment.
- PCMCIA, wireless applications

➤ **STANDARD SPECIFICATIONS:**

Parameters	Minimum	Typical	Maximum	Units	Notes
Frequency Range	12.000		50.000	MHz	
Operation Mode	Fundamental				
Operating Temperature	-10		+60	°C	See options
Storage Temperature	-40		+85	°C	
Frequency Tolerance @+25°C	-50		+50	ppm	See options
Frequency Stability over the Operating Temperature (ref. to +25°C)	-50		+50	ppm	See options
Equivalent series resistance			120	Ω	12.000MHz
			80		12.001MHz ~ 20.000MHz
			60		20.001MHz ~ 28.000MHz
			50		28.001MHz ~ 50.000MHz
Shunt capacitance (C0)			5.0	pF	
Load capacitance (CL)	10			pF	See options
Drive Level		10	100	μW	
Aging@25°C±3°C			±3	ppm	First year
Insulation Resistance	500			M Ω	@ 100Vdc ± 15V

➤ **OPTIONS & PART IDENTIFICATION:**

(Left blank if standard)

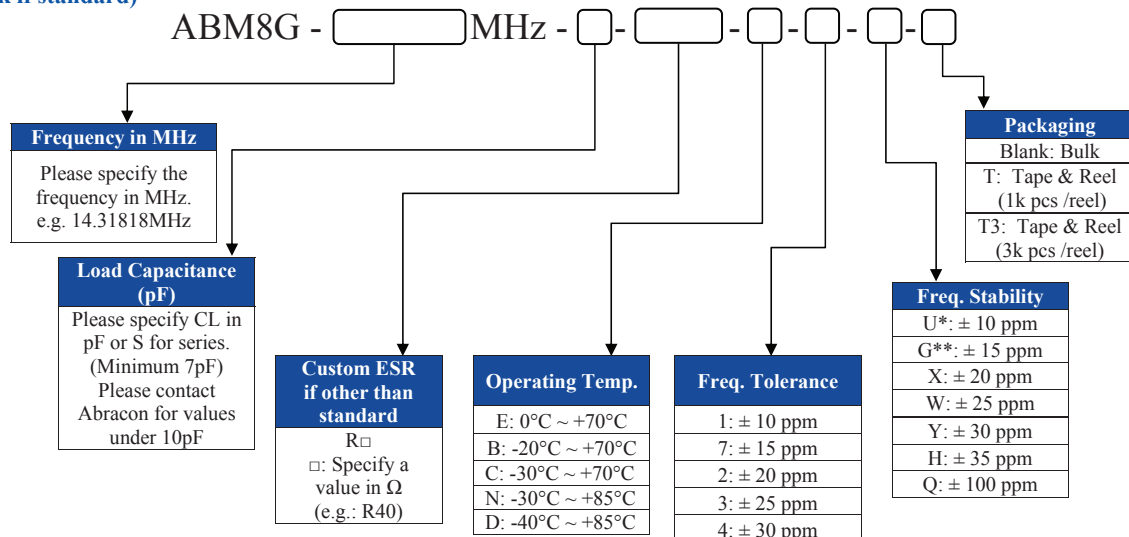

* -10 ~ 60°C only. Contact Abracon for tighter freq. stability.
** -10 ~ 60°C option E, B, C, N only.

ULTRA MINIATURE CERAMIC GLASS SEALED SMD CRYSTAL



3.2 x 2.5 x 1.0mm

ABM8G

Pb in glass exemption 7 (c)-I per
RoHS II 2011/65/EU Annex

RoHS/RoHS II Compliant

OUTLINE DRAWING:



TAPE & REEL:

Tape and reel (1,000pcs/reel)
Tape and reel (3,000pcs/reel)



REFLOW PROFILE:



Need a test socket for the ABM8G Series? To view compatible **PRECISION TEST & BURN-IN SOCKETS** for these parts, [click here](#).

ATTENTION: Abracon Corporation's products are COTS – Commercial-Off-The-Shelf products; suitable for Commercial, Industrial and, where designated, Automotive Applications. Abracon's products are not specifically designed for Military, Aviation, Aerospace, Life-dependant Medical applications or any application requiring high reliability where component failure could result in loss of life and/or property. For applications requiring high reliability and/or presenting an extreme operating environment, written consent and authorization from Abracon Corporation is required. Please contact Abracon Corporation for more information.



ABRACON IS
ISO 9001 : 2008
CERTIFIED



2 Faraday, Suite# B | Irvine | CA 92618 **Revised: 08.13.15**
Ph. 949.546.8000 | Fax. 949.546.8001
Visit www.abracon.com for Terms and Conditions of Sale

Looking for pricing, stock, or lifecycle information?

Click below to explore more details on WIN SOURCE:

-  [View ABM8G-25.000MHZ-18-D2Y-T on WIN SOURCE](#)
-  [Abracon LLC Information](#)

Optimize Your Supply Chain with WIN SOURCE Solutions

-  Global Sourcing Solution
-  Obsolete Management
-  Cost Control Management
-  Shortage Management
-  Alternative Solution
-  Excess Inventory Management