

MINIATURE CERAMIC SMD CRYSTAL



ABM3

5.0 X 3.2 X 1.3mm

ABM3

Pb in Glass, exemption 7C-I per RoHS II Directive 2011/65/EU Annex | **RoHS/RoHS II Compliant.**

Smaller package alternative for ABM7 series

Moisture Sensitivity Level (MSL) – This product is Hermetically Sealed and not Moisture Sensitive - MSL = N/A: Not Applicable

FEATURES:

- AT-cut fundamental or 3rd OT mode
- Suitable for RoHS reflow profile
- Tight Stability available ± 10
- Ceramic package hermetically glass sealed assures high precision and reliability.

APPLICATIONS:

- Cellular telephones, pagers
- Communication and test equipment
- PCMCIA and wireless applications

STANDARD SPECIFICATIONS:

Parameters	Minimum	Typical	Maximum	Units	Notes
Frequency Range	8.000		54.000	MHz	Fundamental
	54.100		80.000		3 rd Overtone
Operation Mode	Fundamental or 3 rd Overtone				
Operating Temperature	-10		+60	°C	See options
Storage Temperature	-40		+90	°C	
Frequency Tolerance @+25°C	-50		+50	ppm	See options
Frequency Stability over the Operating Temperature (ref. to +25°C)	-50		+50	ppm	See options
Equivalent series resistance (R1)			140	Ω	$8.000 \leq F < 9.000$ (Fund)
			120		$9.000 \leq F < 10.000$ (Fund)
			60		$10.000 \leq F < 16.000$ (Fund)
			40		$16.000 \leq F < 20.000$ (Fund)
			30		$20.000 \leq F < 30.000$ (Fund)
			25		$30.000 \leq F \leq 54.000$ (Fund)
			60		$54.000 < F \leq 80.000$ (3 rd OT)
Shunt capacitance (C0)			7	pF	
Load capacitance (CL)		18		pF	Standard (See options if other than STD)
Drive Level		10	100	μ W	
Aging	-5		+5	ppm	@25°C \pm 3°C First year
Insulation Resistance	500			M Ω	@ 100Vdc \pm 15V

MINIATURE CERAMIC SMD CRYSTAL



ABM3

5.0 X 3.2 X 1.3mm

ABM3

Pb in Glass, exemption 7C-I per RoHS II Directive | **RoHS/RoHS II Compliant.**
2011/65/EU Annex

OPTIONS AND PART IDENTIFICATION: (Left blank if standard)

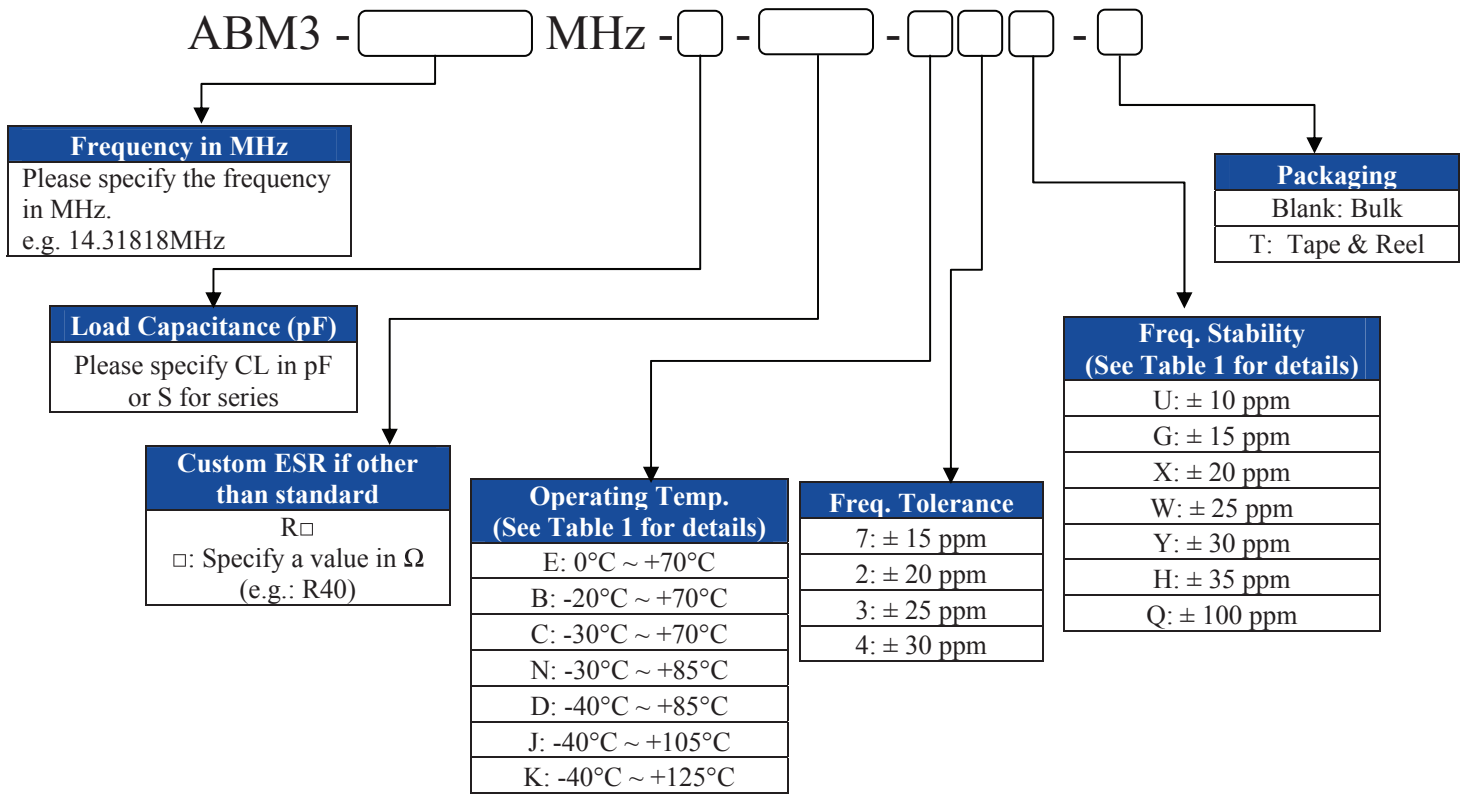

Table 1 Available Combinations of Operating Temp. and Freq. Stability

Operating Temp.	Freq. Stability							
	U:±10ppm	G:±15ppm	X:±20ppm	W:±25ppm	Y:±30ppm	H:±35ppm	Std:±50ppm	Q:±100ppm
Std: -10°C ~ +60°C	√	√	√	√	√	√	√	√
E: 0°C ~ +70°C	√	√	√	√	√	√	√	√
B: -20°C ~ +70°C	√	√	√	√	√	√	√	√
C: -30°C ~ +70°C		√	√	√	√	√	√	√
N: -30°C ~ +85°C		√	√	√	√	√	√	√
D: -40°C ~ +85°C			√	√	√	√	√	√
J: -40°C ~ +105°C							√	√
K: -40°C ~ +125°C							√	√

MINIATURE CERAMIC SMD CRYSTAL



ABM3

5.0 X 3.2 X 1.3mm

ABM3

Pb in Glass, exemption 7C-I per RoHS II Directive | **RoHS/RoHS II Compliant.**
2011/65/EU Annex

OUTLINE DRAWING:

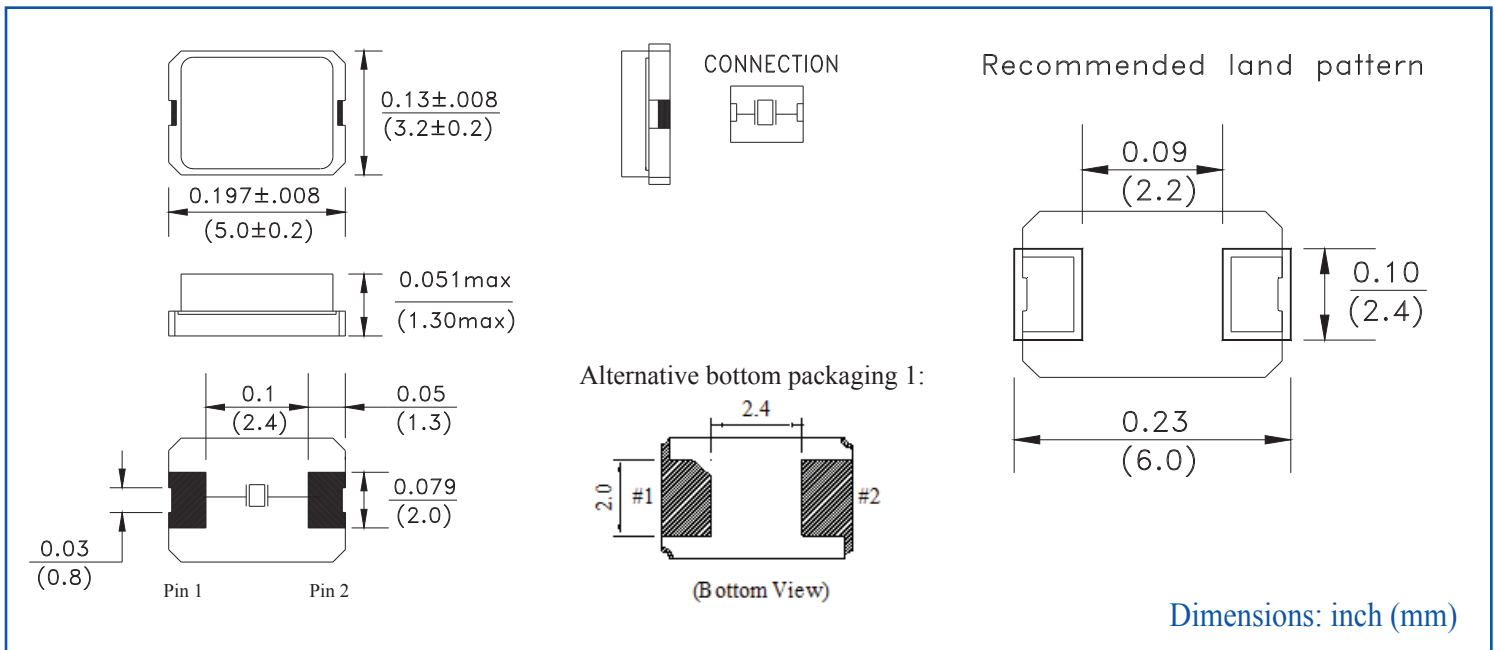

TAPE & REEL:

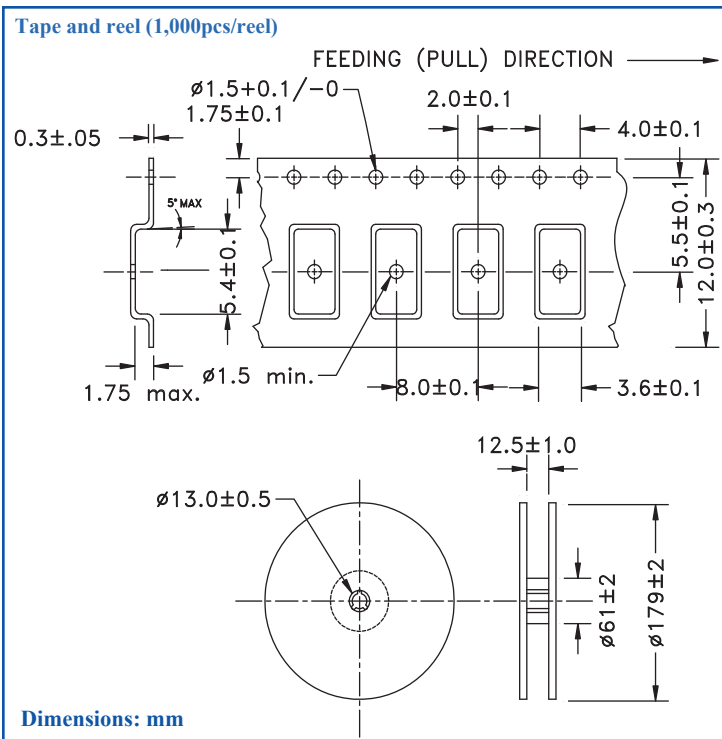

REFLOW PROFILE

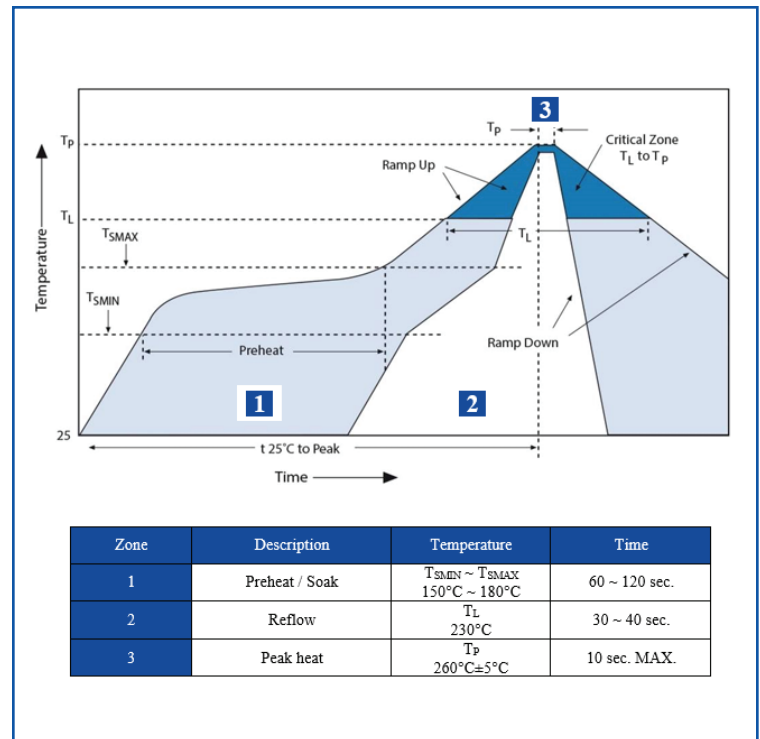

Need a test socket for the ABM3 Series? To view compatible **PRECISION TEST & BURN-IN SOCKETS** for these parts, [click here](#). P/N: **AXS-5032-02-06**

ATTENTION: Abracon LLC's products are COTS – Commercial-Off-The-Shelf products; suitable for Commercial, Industrial and, where designated, Automotive Applications. Abracon's products are not specifically designed for Military, Aviation, Aerospace, Life-dependant Medical applications or any application requiring high reliability where component failure could result in loss of life and/or property. For applications requiring high reliability and/or presenting an extreme operating environment, written consent and authorization from Abracon LLC is required. Please contact Abracon LLC for more information.



1501 Hidden Creek Lane Spicewood TX 78751
Phone: 949-546-8000 | Fax: 949-546-8001
For terms and conditions of sales visit:
www.abracon.com

REVISED: 07/19/2018

ABRACON IS
ISO9001-2015
CERTIFIED

Looking for pricing, stock, or lifecycle information?

Click below to explore more details on WIN SOURCE:

 [View ABM3-12.000MHZ-B2-T on WIN SOURCE](#)

 [Abracon LLC Information](#)

Optimize Your Supply Chain with WIN SOURCE Solutions

-  Global Sourcing Solution
-  Obsolete Management
-  Cost Control Management
-  Shortage Management
-  Alternative Solution
-  Excess Inventory Management