



ded Aluminum electrolytic capacitors

**B41041**

**Single-ended capacitors**  
**Low impedance – 105 °C**

B41041, B43041

**Specifications and characteristics in brief**

Rated voltage $V_R$	6.3 ... 450 V DC									
Operating temperature range	–40 °C ... +105 °C									
Rated capacitance $C_R$ (20 °C, 120 Hz)	0.1 ... 15000 $\mu$ F									
Capacitance tolerance	$\pm 20\% \triangleq M$									
Load life (105 °C, $V_R$ , $I_{AC,R}$ )	2000 h	Requirements: $\Delta C/C \leq \pm 20\%$ of initial value $\tan \delta \leq 2$ times initial specified limit $I_{leak} \leq$ initial specified limit								
Leakage current $I_{leak}$ (20 °C, after 5 minutes)	$I_{leak} \leq 0.03 \mu A \cdot \left( \frac{C_R}{\mu F} \cdot \frac{V_R}{V} \right)$ or 3 $\mu A$ , whichever is greater									
Dissipation factor $\tan \delta$ (20 °C, 120 Hz)	For capacitance higher than 1000 $\mu$ F add 0.02 for every increase of 1000 $\mu$ F									
	$V_R$ (V DC)	6.3	10	16	25	35	50	63 ... 100	160 ... 250	315 ... 450
$\tan \delta$	0.24	0.20	0.16	0.14	0.12	0.10	0.09	0.15	0.20	
Low temperature stability (impedance ratio) (120 Hz)	$V_R$ (V DC)	6.3 ... 10		16	25 ... 100		160 ... 250		315 ... 450	
	$\frac{Z(-40\text{ °C})}{Z(+20\text{ °C})}$	7		5	4		8		6	
Shelf life	After storage for 1000 h at 105 °C, the capacitors shall meet the requirement of load life test after reforming process. After test: $V_R$ to be applied for 30 minutes, 24 to 48 hours before measurement.									
Frequency multiplier for rated ripple current	$V_R$	$C_R$	Frequency							
			50 Hz	120 Hz	1 kHz	10 kHz	100 kHz			
	6.3 ... 100 V	0.1 ... 6.8 $\mu$ F	–	0.4	0.7	0.8	1.0			
		10 ... 68 $\mu$ F	–	0.5	0.8	0.9	1.0			
		100 ... 200 $\mu$ F	–	0.7	0.9	0.9	1.0			
		330 ... 1000 $\mu$ F	–	0.8	0.9	1.0	1.0			
	160 ... 450 V	2200 ... 15000 $\mu$ F	–	0.9	1.0	1.0	1.0			
0.47 ... 330		0.8	1	1.3	1.4	1.6				
Temperature multiplier for rated ripple current			+70 °C		+85 °C		+105 °C			
	6.3 ... 100 V	2.0	1.7		1.0					
	160 ... 400 V	1.8	1.4		1.0					

**Single-ended capacitors**  
**Low impedance – 105 °C**

B41041, B43041

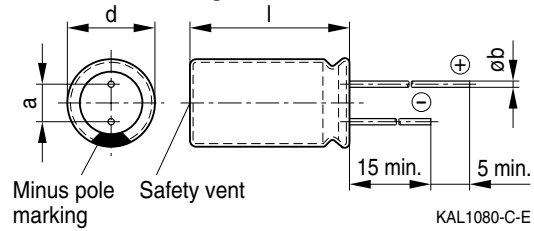
**Dimensional drawing**Safety vent for diameter  $\geq 8$  mm.**Case dimensions**

$d \times l$ mm	$d_{\max} \times l_{\max}$ mm	a mm	b mm
5 × 11	5.5 × 12.5	2.0 ± 0.5	0.5 ± 0.1
6.3 × 11	6.8 × 12.5	2.5 ± 0.5	0.5 ± 0.1
8 × 11.5	8.5 × 13.0	3.5 ± 0.5	0.6 ± 0.1
10 × 12.5	11 × 14.0	5.0 ± 0.5	0.6 ± 0.1
10 × 16	11 × 17.5	5.0 ± 0.5	0.6 ± 0.1
10 × 20	11 × 21.5	5.0 ± 0.5	0.6 ± 0.1
12.5 × 20	13.5 × 22.0	5.0 ± 0.5	0.6 ± 0.1
12.5 × 25	13.5 × 27.0	5.0 ± 0.5	0.6 ± 0.1
16 × 25	17 × 27.0	7.5 ± 0.5	0.8 ± 0.1
16 × 31.5	17 × 33.5	7.5 ± 0.5	0.8 ± 0.1
16 × 35.5	17 × 37.5	7.5 ± 0.5	0.8 ± 0.1
18 × 35.5	19 × 37.5	7.5 ± 0.5	0.8 ± 0.1
18 × 40	19 × 42.0	7.5 ± 0.5	0.8 ± 0.1



**Single-ended capacitors**  
**Low impedance – 105 °C**

**B41041, B43041**

**Overview of available types B41041**

$V_R$ (V DC)	6.3	10	16	25
	Case dimensions $d \times l$ (mm)			
$C_R$ ( $\mu$ F)				
4.7				5 × 11
6.8				5 × 11
10			5 × 11	5 × 11
15			5 × 11	5 × 11
22		5 × 11	5 × 11	5 × 11
33	5 × 11	5 × 11	5 × 11	5 × 11
47	5 × 11	5 × 11	5 × 11	5 × 11
68	5 × 11	5 × 11	6.3 × 11	6.3 × 11
100	5 × 11	5 × 11	6.3 × 11	6.3 × 11
150	6.3 × 11	6.3 × 11	8 × 11.5	8 × 11.5
220	6.3 × 11	6.3 × 11	8 × 11.5	8 × 11.5
330	6.3 × 11	8 × 11.5	8 × 11.5	10 × 12.5
470	8 × 11.5	8 × 11.5	10 × 12.5	10 × 16
680	10 × 12.5	10 × 12.5	10 × 16	12.5 × 20
1000	10 × 12.5	10 × 16	10 × 20	12.5 × 20
1500	10 × 20	10 × 20	12.5 × 20	16 × 25
2200	12.5 × 20	12.5 × 20	12.5 × 25	16 × 25
3300	12.5 × 20	12.5 × 25	16 × 25	16 × 31.5
4700	16 × 25	16 × 25	16 × 31.5	18 × 35.5
6800	16 × 25	16 × 31.5	18 × 35.5	
10000	16 × 31.5	18 × 35.5		
15000	18 × 35.5			

Please read *Cautions and warnings* and *Important notes* at the end of this document.



**Single-ended capacitors**  
**Low impedance – 105 °C**

**B41041, B43041**

**Overview of available types B41004**

$V_R$ (V DC)	35	50	63	100
	Case dimensions $d \times l$ (mm)			
$C_R$ ( $\mu$ F)				
0.10		5 × 11		
0.22		5 × 11		
0.33		5 × 11		
0.47		5 × 11		5 × 11
0.68		5 × 11		5 × 11
1.0		5 × 11		5 × 11
1.5		5 × 11		5 × 11
2.2		5 × 11		5 × 11
3.3		5 × 11		5 × 11
4.7	5 × 11	5 × 11	5 × 11	5 × 11
6.8	5 × 11	5 × 11	5 × 11	6.3 × 11
10	5 × 11	5 × 11	5 × 11	6.3 × 11
15	5 × 11	5 × 11	6.3 × 11	8 × 11.5
22	5 × 11	5 × 11	6.3 × 11	8 × 11.5
33	5 × 11	6.3 × 11	6.3 × 11	10 × 12.5
47	6.3 × 11	6.3 × 11	8 × 11.5	10 × 16
68	8 × 11.5	8 × 11.5	10 × 12.5	10 × 20
100	8 × 11.5	8 × 11.5	10 × 12.5	12.5 × 20
150	10 × 12.5	10 × 12.5	10 × 16	12.5 × 25
220	10 × 12.5	10 × 16	10 × 20	16 × 25
330	10 × 16	10 × 20	12.5 × 20	16 × 25
470	10 × 20	12.5 × 20	12.5 × 25	16 × 31.5
680	12.5 × 25	16 × 25	16 × 31.5	
1000	12.5 × 25	16 × 25	16 × 31.5	
1500	16 × 25	16 × 35.5		
2200	16 × 31.5	18 × 35.5		
3300	18 × 35.5			

Please read *Cautions and warnings* and  
*Important notes* at the end of this document.



**Single-ended capacitors**  
**Low impedance – 105 °C**

**B41041, B43041**

**Overview of available types B43041**

$V_R$ (V DC)	160	200	250
	Case dimensions $d \times l$ (mm)		
$C_R$ ( $\mu$ F)			
2.2			6.3 × 11
3.3		6.3 × 11	8 × 11.5
4.7	6.3 × 11	8 × 11.5	8 × 11.5
6.8	8 × 11.5	8 × 11.5	10 × 12.5
10	8 × 11.5	10 × 12.5	10 × 16
15	10 × 12.5	10 × 16	10 × 20
22	10 × 16	10 × 20	12.5 × 20
33	10 × 20	12.5 × 20	12.5 × 20
47	12.5 × 20	12.5 × 25	12.5 × 25
68	12.5 × 25	12.5 × 25	16 × 25
82	12.5 × 25	16 × 25	16 × 25
100	16 × 25	16 × 25	16 × 31.5
150	16 × 31.5	16 × 31.5	18 × 31.5
220	18 × 31.5	18 × 31.5	18 × 35.5
330	18 × 35.5	18 × 40	

Please read *Cautions and warnings* and *Important notes* at the end of this document.



**Single-ended capacitors**  
**Low impedance – 105 °C**

**B41041, B43041**

**Overview of available types B43041**

$V_R$ (V DC)	350	400	450
	Case dimensions $d \times l$ (mm)		
$C_R$ ( $\mu$ F)			
0.47			6.3 × 11
0.68			6.3 × 11
1.0		6.3 × 11	8 × 11.5
1.5	6.3 × 11	8 × 11.5	8 × 11.5
2.2	8 × 11.5	8 × 11.5	8 × 11.5
3.3	8 × 11.5	8 × 11.5	10 × 12.5
4.7	10 × 12.5	10 × 12.5	10 × 16
6.8	10 × 12.5	10 × 16	10 × 20
10	10 × 16	10 × 20	12.5 × 20
15	10 × 20	12.5 × 20	12.5 × 25
22	12.5 × 20	12.5 × 25	12.5 × 25
33	12.5 × 25	16 × 25	16 × 25
47	16 × 25	16 × 25	16 × 31.5
68	16 × 31.5	16 × 31.5	18 × 31.5
82	18 × 31.5	18 × 31.5	18 × 35.5
100	18 × 35.5	18 × 35.5	18 × 40
150	18 × 40	18 × 40	18 × 45

Please read *Cautions and warnings* and *Important notes* at the end of this document.



**Single-ended capacitors**  
**Low impedance – 105 °C**

B41041, B43041

**Technical data and ordering codes B41041**

V <sub>R</sub>	C <sub>R</sub> 120 Hz 20 °C V DC μF	Case dimensions d × l mm	Z 100 kHz 20 °C Ω	I <sub>AC,R</sub> 100 kHz 105 °C mA	Ordering code (composition see below)
6.3	33	5 × 11	2.5	105	B41041A2336M***
	47	5 × 11	1.5	120	B41041A2476M***
	68	5 × 11	1.3	125	B41041A2686M***
	100	5 × 11	1.2	130	B41041A2107M***
	150	6.3 × 11	1.0	150	B41041A2157M***
	220	6.3 × 11	0.87	180	B41041A2227M***
	330	6.3 × 11	0.58	220	B41041A2337M***
	470	8 × 11.5	0.39	315	B41041A2477M***
	680	10 × 12.5	0.35	370	B41041A2687M***
	1000	10 × 12.5	0.23	500	B41041A2108M***
	1500	10 × 20	0.18	630	B41041A2158M***
	2200	12.5 × 20	0.095	1000	B41041A2228M***
	3300	12.5 × 20	0.090	1050	B41041A2338M***
	4700	16 × 25	0.061	1670	B41041A2478M***
	6800	16 × 25	0.056	1740	B41041A2688M***
	10000	16 × 31.5	0.045	2110	B41041A2109M***
15000	18 × 35.5	0.036	2580	B41041A2159M***	
10	22	5 × 11	2.5	92	B41041A3226M***
	33	5 × 11	1.9	105	B41041A3336M***
	47	5 × 11	1.5	120	B41041A3476M***
	68	5 × 11	1.4	125	B41041A3686M***
	100	5 × 11	1.2	130	B41041A3107M***
	150	6.3 × 11	0.8	160	B41041A3157M***
	220	6.3 × 11	0.58	220	B41041A3227M***
	330	8 × 11.5	0.47	265	B41041A3337M***
	470	8 × 11.5	0.39	315	B41041A3477M***
	680	10 × 12.5	0.30	400	B41041A3687M***
	1000	10 × 16	0.18	615	B41041A3108M***
	1500	10 × 20	0.15	810	B41041A3158M***
	2200	12.5 × 20	0.09	1050	B41041A3228M***
	3300	12.5 × 25	0.068	1300	B41041A3338M***
	4700	16 × 25	0.056	1740	B41041A3478M***
	6800	16 × 31.5	0.045	2110	B41041A3688M***
10000	18 × 35.5	0.036	2580	B41041A3109M***	

\*\*\* = Version

000 = for standard leads, bulk

001 = for kinked leads, bulk

002 = for cut leads, bulk

016 = for taped leads, Ammo pack, lead spacing a = 2.0 mm

007 = for taped leads, Ammo pack, lead spacing a = 2.5 mm

006 = for taped leads, Ammo pack, lead spacing a = 3.5 mm

008 = for taped leads, Ammo pack, lead spacing a = 5.0 mm

Please read *Cautions and warnings* and  
*Important notes* at the end of this document.



**Single-ended capacitors**  
**Low impedance – 105 °C**

B41041, B43041

**Technical data and ordering codes B41041**

V <sub>R</sub>	C <sub>R</sub> 120 Hz 20 °C μF	Case dimensions d × l mm	Z 100 kHz 20 °C Ω	I <sub>AC,R</sub> 100 kHz 105 °C mA	Ordering code (composition see below)
16	10	5 × 11	2.5	92	B41041A4106M***
	15	5 × 11	2.2	98	B41041A4156M***
	22	5 × 11	1.9	105	B41041A4226M***
	33	5 × 11	1.5	120	B41041A4336M***
	47	5 × 11	1.2	130	B41041A4476M***
	68	6.3 × 11	1	150	B41041A4686M***
	100	6.3 × 11	0.58	220	B41041A4107M***
	150	8 × 11.5	0.5	240	B41041A4157M***
	220	8 × 11.5	0.47	290	B41041A4227M***
	330	8 × 11.5	0.39	315	B41041A4337M***
	470	10 × 12.5	0.23	500	B41041A4477M***
	680	10 × 16	0.17	610	B41041A4687M***
	1000	10 × 20	0.12	825	B41041A4108M***
	1500	12.5 × 20	0.1	1000	B41041A4158M***
	2200	12.5 × 25	0.068	1300	B41041A4228M***
	3300	16 × 25	0.056	1740	B41041A4338M***
4700	16 × 31.5	0.045	2110	B41041A4478M***	
6800	18 × 35.5	0.036	2580	B41041A4688M***	
25	4.7	5 × 11	3	85	B41041A5475M***
	6.8	5 × 11	2.7	88	B41041A5685M***
	10	5 × 11	2.5	92	B41041A5106M***
	15	5 × 11	2.2	98	B41041A5156M***
	22	5 × 11	1.9	105	B41041A5226M***
	33	5 × 11	1.5	120	B41041A5336M***
	47	5 × 11	1.2	130	B41041A5476M***
	68	6.3 × 11	0.8	150	B41041A5686M***
	100	6.3 × 11	0.58	220	B41041A5107M***
	150	8 × 11.5	0.5	260	B41041A5157M***
	220	8 × 11.5	0.39	315	B41041A5227M***
	330	10 × 12.5	0.23	500	B41041A5337M***
	470	10 × 16	0.18	615	B41041A5477M***
	680	12.5 × 20	0.14	830	B41041A5687M***
	1000	12.5 × 20	0.09	1050	B41041A5108M***
	1500	16 × 25	0.08	1200	B41041A5158M***
2200	16 × 25	0.056	1740	B41041A5228M***	
3300	16 × 31.5	0.045	2110	B41041A5338M***	
4700	18 × 35.5	0.036	2580	B41041A5478M***	

\*\*\* = Version

000 = for standard leads, bulk

001 = for kinked leads, bulk

002 = for cut leads, bulk

016 = for taped leads, Ammo pack, lead spacing a = 2.0 mm

007 = for taped leads, Ammo pack, lead spacing a = 2.5 mm

006 = for taped leads, Ammo pack, lead spacing a = 3.5 mm

008 = for taped leads, Ammo pack, lead spacing a = 5.0 mm

Please read *Cautions and warnings* and  
*Important notes* at the end of this document.



**Single-ended capacitors**  
**Low impedance – 105 °C**

**B41041, B43041**

**Technical data and ordering codes B41041**

V <sub>R</sub> V DC	C <sub>R</sub> 120 Hz 20 °C μF	Case dimensions d × l mm	Z 100 kHz 20 °C Ω	I <sub>AC,R</sub> 100 kHz 105 °C mA	Ordering code (composition see below)
35	4.7	5 × 11	2.5	92	B41041A7475M***
	6.8	5 × 11	2.2	98	B41041A7685M***
	10	5 × 11	1.9	105	B41041A7106M***
	15	5 × 11	1.7	110	B41041A7156M***
	22	5 × 11	1.5	120	B41041A7226M***
	33	5 × 11	1.5	130	B41041A7336M***
	47	6.3 × 11	0.72	220	B41041A7476M***
	68	8 × 11.5	0.5	240	B41041A7686M***
	100	8 × 11.5	0.39	315	B41041A7107M***
	150	10 × 12.5	0.3	370	B41041A7157M***
	220	10 × 12.5	0.23	500	B41041A7227M***
	330	10 × 16	0.18	615	B41041A7337M***
	470	10 × 20	0.12	825	B41041A7477M***
	680	12.5 × 25	0.1	1000	B41041A7687M***
	1000	12.5 × 25	0.068	1300	B41041A7108M***
	1500	16 × 25	0.06	1500	B41041A7158M***
	2200	16 × 31.5	0.045	2110	B41041A7228M***
3300	18 × 35.5	0.036	2580	B41041A7338M***	
50	0.1	5 × 11	18	10	B41041A6104M***
	0.22	5 × 11	13	15	B41041A6224M***
	0.33	5 × 11	10	18	B41041A6334M***
	0.47	5 × 11	7	23	B41041A6474M***
	0.68	5 × 11	6	25	B41041A6684M***
	1	5 × 11	4.9	35	B41041A6105M***
	1.5	5 × 11	4.6	40	B41041A6155M***
	2.2	5 × 11	4.2	53	B41041A6225M***
	3.3	5 × 11	3.9	65	B41041A6335M***
	4.7	5 × 11	3.6	82	B41041A6475M***
	6.8	5 × 11	3.2	90	B41041A6685M***
	10	5 × 11	2.7	100	B41041A6106M***
	15	5 × 11	2.2	110	B41041A6156M***
	22	5 × 11	1.9	125	B41041A6226M***
	33	6.3 × 11	1.1	195	B41041A6336M***
47	6.3 × 11	0.9	245	B41041A6476M***	
68	8 × 11.5	0.7	310	B41041A6686M***	

\*\*\* = Version

000 = for standard leads, bulk

001 = for kinked leads, bulk

002 = for cut leads, bulk

016 = for taped leads, Ammo pack, lead spacing a = 2.0 mm

007 = for taped leads, Ammo pack, lead spacing a = 2.5 mm

006 = for taped leads, Ammo pack, lead spacing a = 3.5 mm

008 = for taped leads, Ammo pack, lead spacing a = 5.0 mm

Please read *Cautions and warnings* and  
*Important notes* at the end of this document.



**Single-ended capacitors**  
**Low impedance – 105 °C**

B41041, B43041

**Technical data and ordering codes B41041**

V <sub>R</sub>	C <sub>R</sub> 120 Hz 20 °C μF	Case dimensions d × l mm	Z 100 kHz 20 °C Ω	I <sub>AC,R</sub> 100 kHz 105 °C mA	Ordering code (composition see below)
50	100	8 × 11.5	0.5	385	B41041A6107M***
	150	10 × 12.5	0.45	450	B41041A6157M***
	220	10 × 16	0.27	505	B41041A6227M***
	330	10 × 20	0.18	675	B41041A6337M***
	470	12.5 × 20	0.12	895	B41041A6477M***
	680	16 × 25	0.1	1100	B41041A6687M***
	1000	16 × 25	0.076	1495	B41041A6108M***
	1500	16 × 35.5	0.068	1800	B41041A6158M***
	2200	18 × 35.5	0.05	2190	B41041A6228M***
63	4.7	5 × 11	5.8	74	B41041A8475M***
	6.8	5 × 11	4.5	80	B41041A8685M***
	10	5 × 11	3.6	95	B41041A8106M***
	15	6.3 × 11	2.8	110	B41041A8156M***
	22	6.3 × 11	2.1	130	B41041A8226M***
	33	6.3 × 11	1.7	160	B41041A8336M***
	47	8 × 11.5	1.2	305	B41041A8476M***
	68	10 × 12.5	0.9	350	B41041A8686M***
	100	10 × 12.5	0.65	395	B41041A8107M***
	150	10 × 16	0.46	460	B41041A8157M***
	220	10 × 20	0.32	505	B41041A8227M***
	330	12.5 × 20	0.22	660	B41041A8337M***
	470	12.5 × 25	0.16	850	B41041A8477M***
	680	16 × 31.5	0.12	1000	B41041A8687M***
1000	16 × 31.5	0.098	1430	B41041A8108M***	
100	0.47	5 × 11	13	30	B41041A9474M***
	0.68	5 × 11	12	35	B41041A9684M***
	1	5 × 11	11	45	B41041A9105M***
	1.5	5 × 11	10	50	B41041A9155M***
	2.2	5 × 11	9.2	60	B41041A9225M***
	3.3	5 × 11	7.2	67	B41041A9335M***
	4.7	5 × 11	6.3	75	B41041A9475M***
	6.8	6.3 × 11	4.5	88	B41041A9685M***
	10	6.3 × 11	3.3	110	B41041A9106M***
	15	8 × 11.5	2.8	130	B41041A9156M***
	22	8 × 11.5	1.4	165	B41041A9226M***

\*\*\* = Version

000 = for standard leads, bulk

001 = for kinked leads, bulk

002 = for cut leads, bulk

016 = for taped leads, Ammo pack, lead spacing a = 2.0 mm

007 = for taped leads, Ammo pack, lead spacing a = 2.5 mm

006 = for taped leads, Ammo pack, lead spacing a = 3.5 mm

008 = for taped leads, Ammo pack, lead spacing a = 5.0 mm

Please read *Cautions and warnings* and  
*Important notes* at the end of this document.



**Single-ended capacitors**  
**Low impedance – 105 °C**

**B41041, B43041**

**Technical data and ordering codes B41041**

V <sub>R</sub>	C <sub>R</sub> 120 Hz 20 °C μF	Case dimensions d × l mm	Z 100 kHz 20 °C Ω	I <sub>AC,R</sub> 100 kHz 105 °C mA	Ordering code (composition see below)
100	33	10 × 12.5	0.94	305	B41041A9336M***
	47	10 × 16	0.68	320	B41041A9476M***
	68	10 × 20	0.4	410	B41041A9686M***
	100	12.5 × 20	0.28	585	B41041A9107M***
	150	12.5 × 25	0.22	670	B41041A9157M***
	220	16 × 25	0.16	1120	B41041A9227M***
	330	16 × 25	0.13	1290	B41041A9337M***
	470	16 × 31.5	0.11	1350	B41041A9477M***

\*\*\* = Version

000 = for standard leads, bulk

001 = for kinked leads, bulk

002 = for cut leads, bulk

016 = for taped leads, Ammo pack, lead spacing a = 2.0 mm

007 = for taped leads, Ammo pack, lead spacing a = 2.5 mm

006 = for taped leads, Ammo pack, lead spacing a = 3.5 mm

008 = for taped leads, Ammo pack, lead spacing a = 5.0 mm

Please read *Cautions and warnings* and  
*Important notes* at the end of this document.

**Single-ended capacitors**  
**Low impedance – 105 °C**

B41041, B43041

**Technical data and ordering codes B43041**

V <sub>R</sub> V DC	C <sub>R</sub> 120 Hz 20 °C μF	Case dimensions d × l mm	I <sub>AC,R</sub> 100 kHz 105 °C mA	Ordering code (composition see below)
160	4.7	6.3 × 11	34	B43041A1475M***
	6.8	8 × 11.5	46	B43041A1685M***
	10	8 × 11.5	56	B43041A1106M***
	15	10 × 12.5	80	B43041A1156M***
	22	10 × 16	110	B43041A1226M***
	33	10 × 20	150	B43041A1336M***
	47	12.5 × 20	200	B43041A1476M***
	68	12.5 × 25	270	B43041A1686M***
	82	12.5 × 25	295	B43041A1826M***
	100	16 × 25	370	B43041A1107M***
	150	16 × 31.5	508	B43041A1157M***
	220	18 × 31.5	650	B43041A1227M***
	330	18 × 35.5	850	B43041A1337M***
200	3.3	6.3 × 11	30	B43041A2335M***
	4.7	8 × 11.5	43	B43041A2475M***
	6.8	8 × 11.5	57	B43041A2685M***
	10	10 × 12.5	81	B43041A2106M***
	15	10 × 16	112	B43041A2156M***
	22	10 × 20	145	B43041A2226M***
	33	12.5 × 20	182	B43041A2336M***
	47	12.5 × 25	240	B43041A2476M***
	68	12.5 × 25	350	B43041A2686M***
	82	16 × 25	400	B43041A2826M***
	100	16 × 25	460	B43041A2107M***
	150	16 × 31.5	620	B43041A2157M***
	220	18 × 31.5	810	B43041A2227M***
330	18 × 40	1010	B43041A2337M***	
250	2.2	6.3 × 11	27	B43041F2225M***
	3.3	8 × 11.5	32	B43041F2335M***
	4.7	8 × 11.5	46	B43041F2475M***
	6.8	10 × 12.5	64	B43041F2685M***
	10	10 × 16	88	B43041F2106M***
	15	10 × 20	120	B43041F2156M***
	22	12.5 × 20	160	B43041F2226M***
	33	12.5 × 20	190	B43041F2336M***

\*\*\* = Version

000 = for standard leads, bulk

001 = for kinked leads, bulk

002 = for cut leads, bulk

016 = for taped leads, Ammo pack, lead spacing a = 2.0 mm

007 = for taped leads, Ammo pack, lead spacing a = 2.5 mm

006 = for taped leads, Ammo pack, lead spacing a = 3.5 mm

008 = for taped leads, Ammo pack, lead spacing a = 5.0 mm

Please read *Cautions and warnings* and  
*Important notes* at the end of this document.

**Single-ended capacitors**  
**Low impedance – 105 °C**

B41041, B43041

**Technical data and ordering codes B43041**

V <sub>R</sub> V DC	C <sub>R</sub> 120 Hz 20 °C μF	Case dimensions d × l mm	I <sub>AC,R</sub> 100 kHz 105 °C mA	Ordering code (composition see below)
250	47	12.5 × 25	270	B43041F2476M***
	68	16 × 25	350	B43041F2686M***
	82	16 × 25	400	B43041F2826M***
	100	16 × 31.5	460	B43041F2107M***
	150	18 × 31.5	620	B43041F2157M***
	220	18 × 35.5	830	B43041F2227M***
350	1.5	6.3 × 11	19	B43041A4155M***
	2.2	8 × 11.5	30	B43041A4225M***
	3.3	8 × 11.5	34	B43041A4335M***
	4.7	10 × 12.5	50	B43041A4475M***
	6.8	10 × 12.5	70	B43041A4685M***
	10	10 × 16	92	B43041A4106M***
	15	10 × 20	130	B43041A4156M***
	22	12.5 × 20	165	B43041A4226M***
	33	12.5 × 25	220	B43041A4336M***
	47	16 × 25	290	B43041A4476M***
	68	16 × 31.5	380	B43041A4686M***
	82	18 × 31.5	480	B43041A4826M***
	100	18 × 35.5	520	B43041A4107M***
	150	18 × 40	650	B43041A4157M***
400	1	6.3 × 11	19	B43041A9105M***
	1.5	8 × 11.5	26	B43041A9155M***
	2.2	8 × 11.5	32	B43041A9225M***
	3.3	8 × 11.5	40	B43041A9335M***
	4.7	10 × 12.5	56	B43041A9475M***
	6.8	10 × 16	77	B43041A9685M***
	10	10 × 20	104	B43041A9106M***
	15	12.5 × 20	143	B43041A9156M***
	22	12.5 × 25	210	B43041A9226M***
	33	16 × 25	280	B43041A9336M***
	47	16 × 25	370	B43041A9476M***
	68	16 × 31.5	480	B43041A9686M***
	82	18 × 31.5	500	B43041A9826M***
	100	18 × 35.5	580	B43041A9107M***
150	18 × 40	770	B43041A9157M***	

\*\*\* = Version

000 = for standard leads, bulk

001 = for kinked leads, bulk

002 = for cut leads, bulk

016 = for taped leads, Ammo pack, lead spacing a = 2.0 mm

007 = for taped leads, Ammo pack, lead spacing a = 2.5 mm

006 = for taped leads, Ammo pack, lead spacing a = 3.5 mm

008 = for taped leads, Ammo pack, lead spacing a = 5.0 mm

Please read *Cautions and warnings* and  
*Important notes* at the end of this document.



**Single-ended capacitors**  
**Low impedance – 105 °C**

**B41041, B43041**

**Technical data and ordering codes B43041**

V <sub>R</sub> V DC	C <sub>R</sub> 120 Hz 20 °C μF	Case dimensions d × l mm	I <sub>AC,R</sub> 100 kHz 105 °C mA	Ordering code (composition see below)
450	0.47	6.3 × 11	13	B43041A5474M***
	0.68	6.3 × 11	16	B43041A5684M***
	1.0	8 × 11.5	23	B43041A5105M***
	1.5	8 × 11.5	28	B43041A5155M***
	2.2	8 × 11.5	34	B43041A5225M***
	3.3	10 × 12.5	49	B43041A5335M***
	4.7	10 × 16	65	B43041A5475M***
	6.8	10 × 20	90	B43041A5685M***
	10	12.5 × 20	125	B43041A5106M***
	15	12.5 × 25	170	B43041A5156M***
	22	12.5 × 25	210	B43041A5226M***
	33	16 × 25	280	B43041A5336M***
	47	16 × 31.5	380	B43041A5476M***
	68	18 × 31.5	480	B43041A5686M***
	82	18 × 35.5	550	B43041A5826M***
100	18 × 40	650	B43041A5107M***	
150	18 × 45	800	B43041A5157M***	

\*\*\* = Version

- 000 = for standard leads, bulk
- 001 = for kinked leads, bulk
- 002 = for cut leads, bulk
- 016 = for taped leads, Ammo pack, lead spacing a = 2.0 mm
- 007 = for taped leads, Ammo pack, lead spacing a = 2.5 mm
- 006 = for taped leads, Ammo pack, lead spacing a = 3.5 mm
- 008 = for taped leads, Ammo pack, lead spacing a = 5.0 mm

Please read *Cautions and warnings* and  
*Important notes* at the end of this document.

**Single-ended capacitors**

**B41041, B43041**

**Taping, packing and lead configurations**

**Taping, packing and lead configurations of single-ended capacitors**

Single-ended capacitors are available taped in Ammo pack from diameter 4 to 10 mm as follows:

**Lead spacing 2.0 mm ( $\varnothing d = 4 \dots 5$  mm)**

Last 3 digits of ordering code: 016

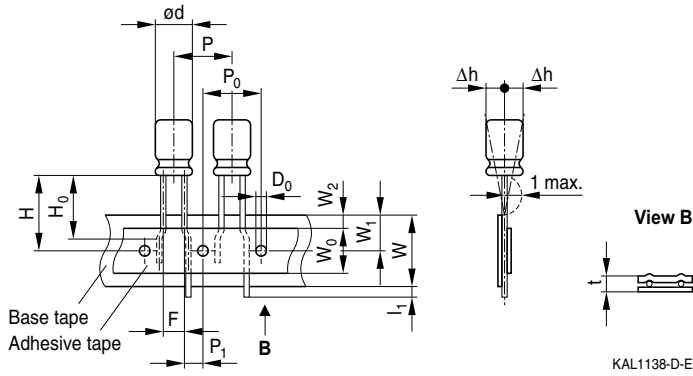

**Dimensions in mm**

$\varnothing d$	F	H	W	$W_0$	$W_1$	$W_2$	P	$P_0$	$P_1$	$l_1$	t	$\Delta h$	$D_0$
4 ... 5	2.0	18.5	18.0	7.0	9.0	3.0	12.7	12.7	5.10	1.0	0.7	1	4.0
	-0.2	$\pm 0.75$	$\pm 0.5$	min.	$\pm 0.5$	max.	$\pm 1.0$	$\pm 0.3$	$\pm 0.7$	max.	$\pm 0.2$	$\pm 1.0$	$\pm 0.2$

Please read *Cautions and warnings* and *Important notes* at the end of this document.



**Single-ended capacitors**

**B41041, B43041**

**Taping, packing and lead configurations**

**Lead spacing 2.5 mm ( $\varnothing d = 4 \dots 6.3$  mm)**

Last 3 digits of ordering code: 007

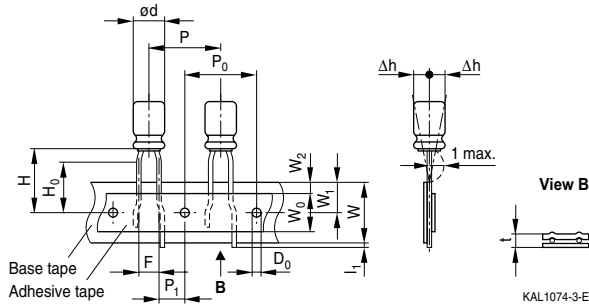

**Dimensions in mm**

$\varnothing d$	F	H	H <sub>0</sub>	W	W <sub>0</sub>	W <sub>1</sub>	W <sub>2</sub>	P	P <sub>0</sub>	P <sub>1</sub>	l <sub>1</sub>	t	$\Delta h$	D <sub>0</sub>
4 ... 6.3	2.5	18.5	16.0	18.0	7.0	9.0	3.0	12.7	12.7	5.10	1.0	0.7	0	4.0
Tolerance	-0.2	$\pm 0.75$	$\pm 0.5$	$\pm 0.5$	min.	$\pm 0.5$	max.	$\pm 1.0$	$\pm 0.3$	$\pm 0.7$	max.	$\pm 0.2$	$\pm 1.0$	$\pm 0.2$

**Lead spacing 3.5 mm ( $\varnothing d = 8$  mm)**

Last 3 digits of ordering code: 006

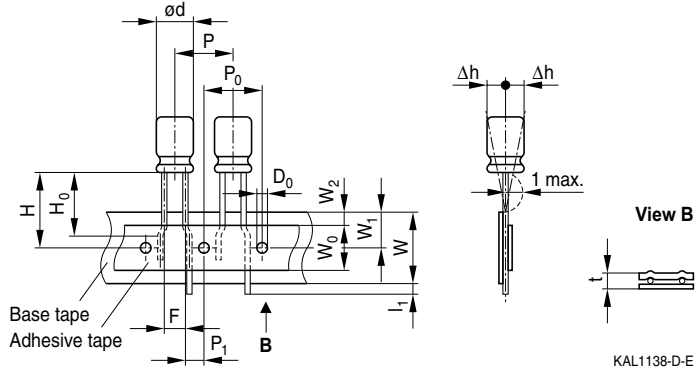

**Dimensions in mm**

$\varnothing d$	F	H	W	W <sub>0</sub>	W <sub>1</sub>	W <sub>2</sub>	P	P <sub>0</sub>	P <sub>1</sub>	l <sub>1</sub>	t	$\Delta h$	D <sub>0</sub>
8	3.5	18.5	18.0	10	9.0	3.0	12.7	12.7	5.10	1.0	0.7	1	4.0
Tolerance	$\pm 0.5$	$\pm 0.75$	$\pm 0.5$	min.	$\pm 0.5$	max.	$\pm 1.0$	$\pm 0.3$	$\pm 0.7$	max.	$\pm 0.2$	max.	$\pm 0.2$

Please read *Cautions and warnings* and *Important notes* at the end of this document.

**Single-ended capacitors**

**B41041, B43041**

**Taping, packing and lead configurations**

**Lead spacing 5.0 mm (∅ d = 4 ... 8 mm)**

Last 3 digits of ordering code: 008

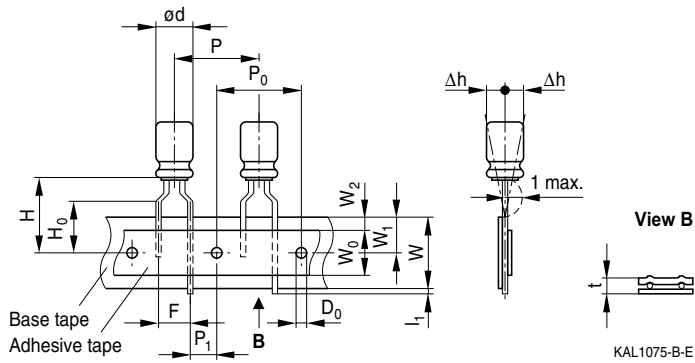

**Lead spacing 5.0 mm (∅ d = 10 mm)**

Last 3 digits of ordering code: 008

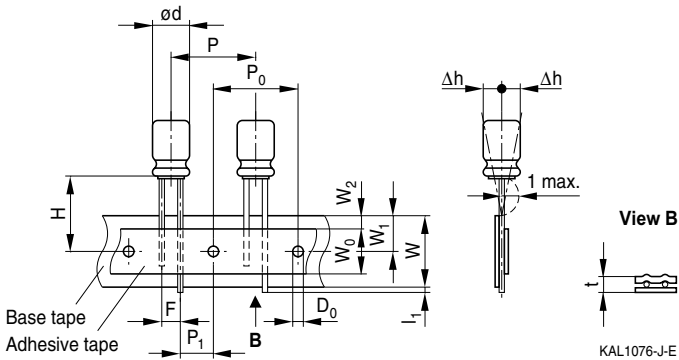

**Dimensions in mm**

∅ d	F	H	H <sub>0</sub>	W	W <sub>0</sub>	W <sub>1</sub>	W <sub>2</sub>	P	P <sub>0</sub>	P <sub>1</sub>	L <sub>1</sub>	t	Δh	D <sub>0</sub>
4 ... 6.3	5.0	18.5	16	18.0	7.0	9.0	3.0	12.7	12.7	3.85	1.0	0.6	2.0	4.0
8	5.0	18.5	16	18.0	10	9.0	3.0	12.7	12.7	3.85	1.0	0.6	2.0	4.0
10	5.0	18.5	—	18.0	12.5	9.0	3.0	12.7	12.7	3.85	1.0	0.6	2.0	4.0
Tolerance	+0.6 -0.2	±0.75	±0.5	+1.0 -0.5	+1.0 -0	±0.5	max.	±0.5	±0.3	±0.7	max.	+0.3 -0.2	max.	±0.2

Taping is available up to dimensions d × l = 10 × 20 mm. For ∅ 12.5, 16 and 18 mm taping is not available.

Please read *Cautions and warnings* and *Important notes* at the end of this document.



**Single-ended capacitors**

**B41041, B43041**

**Taping, packing and lead configurations**

**Kinked or cut leads**

Single-ended capacitors are available with kinked or cut leads. Other lead configurations also available on request.

**Kinked leads**

Last 3 digits of ordering code: 001

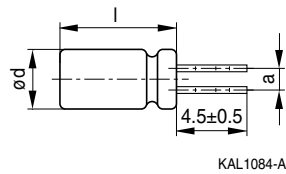
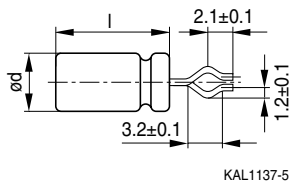

Case size d × l (mm)	a (mm)
4 × 7	1.5
5 × 7	2.0
5 × 11	2.0
6.3 × 7	2.5
6.3 × 11	2.5
6.3 × 15	2.5
8 × 7	3.5
8 × 11.5	3.5
8 × 15	3.5
8 × 20	3.5
10 × 12.5	5.0
10 × 16	5.0
10 × 20	5.0
10 × 25	5.0
10 × 31.5	5.0

Case size d × l (mm)	a (mm)
12.5 × 16	5.0
12.5 × 20	5.0
12.5 × 25	5.0
12.5 × 31.5	5.0
12.5 × 35.5	5.0
12.5 × 40	5.0
16 × 20	7.5
16 × 25	7.5
16 × 31.5	7.5
16 × 35.5	7.5
16 × 40	7.5
18 × 20	7.5
18 × 25	7.5
18 × 31.5	7.5
18 × 35.5	7.5
18 × 40	7.5

Please read *Cautions and warnings* and *Important notes* at the end of this document.



**Single-ended capacitors**

**B41041, B43041**

**Taping, packing and lead configurations**

**Cut leads**

Last 3 digits of ordering code: 002

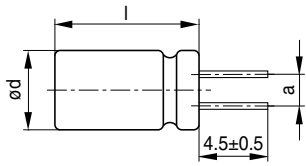

KAL1086-R

Case size d × l (mm)	a (mm)
4 × 7	1.5
5 × 7	2.0
5 × 11	2.0
6.3 × 7	2.5
6.3 × 11	2.5
6.3 × 15	2.5
8 × 7	3.5
8 × 11.5	3.5
8 × 15	3.5
8 × 20	5.0
10 × 12.5	5.0
10 × 16	5.0
10 × 20	5.0
10 × 25	5.0
10 × 31.5	5.0

Case size d × l (mm)	a (mm)
12.5 × 16	5.0
12.5 × 20	5.0
12.5 × 25	5.0
12.5 × 31.5	5.0
12.5 × 35.5	5.0
12.5 × 40	5.0
16 × 20	7.5
16 × 25	7.5
16 × 31.5	7.5
16 × 35.5	7.5
16 × 40	7.5
18 × 20	7.5
18 × 25	7.5
18 × 31.5	7.5
18 × 35.5	7.5
18 × 40	7.5

Please read *Cautions and warnings* and *Important notes* at the end of this document.

## Cautions and warnings

### General

Also see "Important notes" on page 24.

- 1 Aluminum electrolytic capacitors have a bi-polar structure. This is marked on the body of the capacitor. A capacitor must not be mounted with reversed polarity. The application of an AC or reverse voltage may cause a short circuit or damage the capacitor. Bi-polar capacitors must not be used in AC applications, where the polarity may be reversed in the circuits or is unknown.
- 2 The DC voltage applied to the capacitor terminal must not exceed its rated operating voltage, as this will result in a rapid increase of the leakage current and may damage the capacitor. It is recommended to operate the capacitor at 70–80% of its rated voltage to optimize its service life.
- 3 The ripple current applied to the capacitor must be within the permitted range. An excessive ripple current leads to impaired electrical properties and may damage the capacitor. Note that the sum of the peak values of the ripple voltage and the DC operating voltage must not exceed the rated DC voltage.
- 4 Capacitors must be used within their permitted range of operating temperature. Operation at room temperature optimizes their service life.
- 5 Capacitors with case diameter  $\geq 8$  mm are equipped with a safety vent. In capacitors fitted with a lead or soldering lug, the safety vent is usually located at the base of the case. It needs sufficient space around it to operate optimally. The following dimensions are recommended: for case diameter  $d = 8$  to 16 mm, more than 2 mm; for  $d = 18$  to 35 mm, more than 3 mm; and for  $d = 42$  mm or more, more than 5 mm.
- 6 Capacitors should not be mounted with the safety vent face down on the board. Do not locate any wire or copper trace near the safety vent. Do not reverse the voltage, as this may result in excess pressure and the leakage of electrolyte.
- 7 Gas is released through the safety vent when the pressure inside the capacitor is too high. A gaseous liquid around the safety vent does not indicate a leakage of electrolyte.
- 8 The capacitor should be stored under conditions of normal temperature and in a non-acid, non-alkali environment of normal humidity. Exposure to high temperatures, for example under direct sunlight, will reduce its operating life. If the capacitor is stored in an environment containing acids or alkalis, the solderability of the leads may be affected.
- 9 The leakage current of an aluminum electrolytic capacitor may increase after a long period of storage. After such storage, the capacitor must be aged by applying the rated operating voltage for 6–8 hours before use.
- 10 Manual soldering:
  - a Soldering must be performed within the specified conditions.  
Bit temperature: 350 °C; application time of soldering iron: 3 seconds.
  - b Ensure that the soldering iron does not touch any part of the capacitor body.

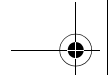

### Cautions and warnings

- 11 Do not apply excessive force to the leads and terminals. Do not move the capacitor after soldering it onto the PC board and do not carry the PC board by gripping the capacitor. Observe the following rules to prevent undue stress to the capacitor:
  - a Do not tilt or bend the capacitor after soldering.
  - b Ensure that the terminal spacing matches the corresponding hole spacing on the PC board.
- 12 The aluminum case is not insulated from the cathode. Do not place a conductor under the aluminum capacitors on the PC board as this may cause a short circuit. The case and top of capacitors used in switched mode power supplies have a high-voltage-resistant heat shrink sleeve to ensure safe usage.
- 13 The leads of capacitors with a case diameter exceeding 14 mm cannot be used for fixing.

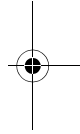
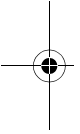

Please read *Cautions and warnings* and *Important notes* at the end of this document.

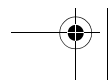
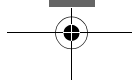



## Important notes

The following applies to all products named in this publication:

1. Some parts of this publication contain **statements about the suitability of our products for certain areas of application**. These statements are based on our knowledge of typical requirements that are often placed on our products in the areas of application concerned. We nevertheless expressly point out **that such statements cannot be regarded as binding statements about the suitability of our products for a particular customer application**. As a rule, EPCOS is either unfamiliar with individual customer applications or less familiar with them than the customers themselves. For these reasons, it is always ultimately incumbent on the customer to check and decide whether an EPCOS product with the properties described in the product specification is suitable for use in a particular customer application.
2. We also point out that **in individual cases, a malfunction of electronic components or failure before the end of their usual service life cannot be completely ruled out in the current state of the art, even if they are operated as specified**. In customer applications requiring a very high level of operational safety and especially in customer applications in which the malfunction or failure of an electronic component could endanger human life or health (e.g. in accident prevention or life-saving systems), it must therefore be ensured by means of suitable design of the customer application or other action taken by the customer (e.g. installation of protective circuitry or redundancy) that no injury or damage is sustained by third parties in the event of malfunction or failure of an electronic component.
3. **The warnings, cautions and product-specific notes must be observed.**
4. In order to satisfy certain technical requirements, **some of the products described in this publication may contain substances subject to restrictions in certain jurisdictions (e.g. because they are classed as hazardous)**. Useful information on this will be found in our Material Data Sheets on the Internet ([www.epcos.com/material](http://www.epcos.com/material)). Should you have any more detailed questions, please contact our sales offices.
5. We constantly strive to improve our products. Consequently, **the products described in this publication may change from time to time**. The same is true of the corresponding product specifications. Please check therefore to what extent product descriptions and specifications contained in this publication are still applicable before or when you place an order.  
We also **reserve the right to discontinue production and delivery of products**. Consequently, we cannot guarantee that all products named in this publication will always be available. The aforementioned does not apply in case of individual agreements deviating from the foregoing for customer-specific products.
6. Unless otherwise agreed in individual contracts, **all orders are subject to the current version of the "General Terms of Delivery for Products and Services in the Electrical Industry" published by the German Electrical and Electronics Industry Association (ZVEI)**.
7. The trade names EPCOS, BAOKE, Alu-X, CeraDiode, CSSP, CTVS, DSSP, MiniBlue, MKK, MLSC, MotorCap, PCC, PhaseCap, PhaseMod, SIFERRIT, SIFI, SIKOREL, SilverCap, SIMDAD, SIMID, SineFormer, SIOV, SIP5D, SIP5K, ThermoFuse, WindCap are **trademarks registered or pending** in Europe and in other countries. Further information will be found on the Internet at [www.epcos.com/trademarks](http://www.epcos.com/trademarks).

ing for pricing, stock, or lifecycle information?

elow to explore more details on WIN SOURCE:

ow [B43041A1156M](#) on WIN SOURCE

[COS \(TDK\)](#) Information

## imize Your Supply Chain with WIN SOURCE Solutions

lobal Sourcing Solution

solete Management

st Control Management

ortage Management

ernative Solution

ress Inventory Management