



**THE DATASHEET OF  
MDM-9PMCBRM7-1-A174**





**ITT**



**ITT**

**Cannon Miniature  
Connectors Customer  
Support Locations**

*ASIA*

Tuopandun Industrial Area, Jinda Cheng,  
Xiner Village, Shajing Town,  
Baoan District, Shenzhen City,  
Guangdong, China 518125  
Phone: (86) 755 2726 7238  
Fax: (86) 755 2726 7515

*GERMANY*

Cannonstrasse 1  
Weinstadt, 71384  
phone: 49.7151.699.0  
fax: 49.7151.699.217

*ITALY*

Corso Europa 41/43  
Lainate (MI),  
Italy 20020  
phone: 39.02938721  
fax: 39.0293872300

*UK*

Jays Close, Viabes Estate  
Basingstoke, RG22 4BA  
phone: 44.1256.311200  
fax: 44.1256.323356

*USA*

666 East Dyer Road  
Santa Ana, CA 92705  
toll free: 1.800.854.3028  
phone: 1.714.557.4700  
fax: 1.714.628.2142

*Engine*

**[www.ittcannon.com](http://www.ittcannon.com)**

©2006 ITT Corporation. "Engineered for life" and "Cannon" are registered trademarks of ITT Corporation. Specification and other data are based on information available at the time of printing, and are subject to change without notice.

CMC-08-06



# Cannon Microminiature Products



## High Performance Micro Miniature Connectors

ITT Electronic Components is a division of the multi-national ITT Corporation a \$7.5 billion dollar global enterprise. The Cannon Micro Connector portfolio has witnessed many product extensions since ITT first introduced micro technology to the marketplace over fifty years ago. Our portfolio remains the most extensive in the industry offering the most reliable and cost effective range of micro interconnect solutions. These innovations have enabled ITT to provide products and technologies to such markets as:

- Aerospace
- Computers Systems
- Defense Electronics
- Geophysical
- Industrial Automation
- Medical Electronics
- Network Systems
- Telecom Switching
- Underwater Systems
- Wireless

Offering the broadest selections of standard and custom micro interconnect solutions, ITT is the one stop source for design, development, manufacturing, and test of sophisticated multi channel high density connectors. Our product portfolio consists of rectangular, circular, quick disconnect, high speed signal, filter, hermetic, mixed signal packages, and strip style interconnects. Each product has unique mechanical engagement and locking mechanisms to meet the demands of harsh environment applications. These products include our Centi Line .100-inch and .075-inch center spacing, the Micro line .050 inch center spacing, and our Nano line of .025-inch center contact spacing. All of ITT's micro connectors utilize our twist pin contact

system, developed by ITT in the early 1960's. A separate section describes in detail the twist pin electrical contact technology (refer to page 6).

## The Standard of Six Sigma

When you specify a Cannon microminiature connector, you can rely on a product designed, developed, and manufactured to the highest quality and reliability standards in the industry. This tradition of excellence is based on ITT's corporate culture of operating its entire business under the



principles of Six Sigma. At ITT, Six Sigma is not just a quality philosophy but a complete corporate culture that drives the entire business. Our Value Based

Management and Value Based Product Development systems are two cornerstones of ITT that allows for the development of both leadership and product development principles, ensuring that the correct industry leading products are



developed to the accepted market driven lead times. These principles have allowed ITT to become the market leader

in all of our business portfolios.

## Six Sigma Engineering

ITT, utilizing its six sigma tools and multiple lean initiatives, offers the most experienced engineering design team in



the micro miniature interconnect field. Using our systems approach, ITT continues to advance new interconnect technologies by developing advanced products including higher density Nano 0.025-inch spacing interconnects, Chip-on-Flex filter connectors, flexible high density circuits terminated directly to ITT contacts, and innovative high speed mixed signal connector configurations.

In conjunction with our design teams, ITT operates a world class test lab offering state of the art capabilities in electronic, fiber optic, and mechanical test expertise. Our certified test engineers and technicians can develop a specific test plan based on our customer's specific needs. Additionally, our team is experienced in providing test services and programs for US DOD Defense electronics and Space related programs.



## Six Sigma Manufacturing

ITT operates manufacturing facilities in the United States, France, Germany, Italy, Mexico, China, and the UK, all of



# Cannon Microminiature Products

which have particular product area strengths allowing ITT to offer a truly global footprint to our customers. Our facilities are world class and accommodate full vertical integration with the latest manufacturing technologies including: automated and robotic machining centers, Super Market manufacturing cells, Kanban pull systems, and automated electrical, mechanical, and optical test and inspection equipment. The combination of our manufacturing strength and our advanced manufacturing facilities allows ITT to offer products at market driven prices. Our capabilities, especially in robotics, computerized precision tooling, Kaizen Project Management, Six Sigma tools, and test labs, gives ITT the most optimized global manufacturing footprint in the interconnect industry.



viding terminated flex circuit assemblies, high temperature geophysical cable assemblies, innovative medical electronics cable assemblies, over mold strain relief systems, and EMI shielded terminations.

## RoHS Compliance Information

ITT has implemented a strict parts control plan for all ITT electronics plants worldwide that allows the Cannon Microminiature



connector product portfolio to meet the requirements of European Union Directive 2002/95/EC better known as the Reduction of Hazardous Substances initiative. To make things easier for our customers, all Cannon Microminiature products can be ordered with an R prefix number which insures our customers will receive RoHS compliant parts for their commercial electronics applications and equipment. Since most RoHS hazardous substances center around specific metal plating and lead solder coatings, ITT's products for RoHS compliance are available in the following plating finishes: electroless nickel, stainless steel, Anodize over aluminum and Gold plating. It should be noted that gold plating would be recommended as the replacement for tin-lead solder when ordering board mount connectors.



## The Custom Difference

As the industry leader in harsh environment interconnect applications, ITT's world class engineering teams will work directly

with our customers to design and develop cost effective solutions for their applications. In many cases we may modify one of our standard designs to ensure a highly reliable solution where timing is critical. Yet, in those cases where a complete custom interconnect solution is required, ITT will work with our customer's Engineers to design an interconnect solution which will be cost effective yet highly reliable. As professional consultants, our Engineering teams will provide a thorough systems and mechanical analysis of any proposed solution. These analyses provide our customers with sophisticated electrical signal and mechanical characterizations to determine the best solution for their application.



## Non Compliant RoHS Materials

Advanced Aerospace specifications and DOD system performance requirements demand the necessity to maintain production status for the primary base metals and Chem film coatings typically utilized in Aerospace electronics. Thus, in order to support ITT's Aerospace customer base and maintain

our leadership position in micro miniature connector technologies, ITT will continue to provide interconnect products with cadmium plating and tin lead solder in support of these markets. These materials are all QPL to Military specifications including M83513.



In addition to custom connectors, ITT offers sophisticated custom cable assembly capabilities for a wide range of harsh environment applications.

Our in house expertise translates to our ability to integrate different technologies within a custom cable harness. ITT's capabilities include discrete wire terminations to multi wire cable harnesses with multiple connector configurations as part of the final assembly. We also specialize in pro-





Please consult Customer Service if RoHS part verification is required.












# Table of Contents

Introduction . . . . .	2
Microminiature Product Overview Guide . . . . .	5
Twist Pin Contact System . . . . .	6
Micro-D Metal Shell - .050" Contact Spacing (MDM) . . . . .	7
Micro-D PCB - .050" Contact Spacing (MDM-PCB) . . . . .	18
Micro-D Coaxial/Power - .050" Contact Spacing (MDM-C/P) . . . . .	22
Hermetic (MDMH) . . . . .	23
Filter (TMDM) . . . . .	25
Micro-D Plastic Shell - .050" Contact Spacing (MD/MDV) . . . . .	28
Micro Center Jackscrew (MJS) . . . . .	39
Microminiature Circular - .050" Contact Spacing (MIK, MIKM, MIKQ) . . . . .	44
Microstrips .050" Contact Spacing (MT) . . . . .	48
Microminiature Strip - .100/.050" Contact Spacing (MT) . . . . .	52
Micro Edgeboard - .050" Contact Spacing (MEB) . . . . .	54
The Centi Line - .075" Contact Spacing (2D) . . . . .	59
Centi-D Loc-.075" Contact Spacing (CDL) . . . . .	65
Strip Connectors - .100"/.075" Contact Spacing . . . . .	66
The NANO Line - .025" Contact Spacing . . . . .	70
Strip Connectors - .025" Contact Spacing (NT) . . . . .	71
NANO D Metal Shell - .025" Contact Spacing (NDM) . . . . .	72
Center Jackscrew - .030" Contact Spacing (NJS) . . . . .	73
Custom Cable Assemblies . . . . .	75
Flex Circuit Cable Assembly . . . . .	77
Custom Back Shells . . . . .	78
Appendix	
Standard Wire Termination "L" Code Chart . . . . .	79
Standard Wire Termination "H" Code Chart . . . . .	81
Wire Color Code Chart . . . . .	83
Terminology . . . . .	84
Product Safety Information . . . . .	85

# Cannon Microminiature Product Overview Guide

	MDM	MDM PCB	MDM C/P	MDMH Hermetics	TMDM Filter	MD**	MDB Coaxial	MJS	MIK	MIKM
										
<b>Type</b>	Plug and Socket	Plug and Socket	Plug and Socket	Plug and Socket	Plug and Socket	Plug and Socket	Plug and Socket	Plug and Socket	Plug and Socket	Plug and Socket
<b>Current Rating</b>	3A max.	3A max.	3A max.	3A max.	3A max.	3A max.	3A max.	3A max.	3A max.	3A max.
<b>Contact Resistance</b>	8 milliohms max.	8 milliohms max.	8 milliohms max.	24 milliohms max.	15 milliohms max.	8 milliohms max.	8 milliohms max. (signal)	8 milliohms max.	8 milliohms max.	8 milliohms max.
<b>Contact Material</b>	gold plated copper alloy	gold plated copper alloy	gold plated copper alloy	gold plated copper and steel	gold plated copper alloy	gold plated copper alloy	gold plated copper alloy	gold plated copper alloy	gold plated copper alloy	gold plated copper alloy
<b>Shell</b>	Metal	Metal	Metal	Metal	Metal	Plastic	Plastic	Plastic	Plastic	Metal
<b>Shell Material</b>	Aluminum	Aluminum	Aluminum	Steel	Aluminum	Thermoplastic & Thermoset	Thermoset	Thermoplastic & Thermoset	Thermoplastic	Steel
<b>Available Layouts</b>	9, 15, 21, 25, 31, 37, 51 & 100	9, 15, 21, 25, 31, 37, 51 & 100	7C/P2, 24C/P4, 27C/P5 & 10C/P10	9, 15, 21, 25, 31, 37 & 51	9, 15, 21, 25, 31, 37 & 51	9, 15, 21, 25, 31, 37 & 51	7C/P2	10, 26, 51 & 66 - Rect/unshrouded 16, 28 & 35 - Rect/shrouded 26, 38, 42 & 76 - Polarized D	7 & 55	7, 55 & 85
<b>Configuration</b>	Polarized D	Polarized D	Polarized D	Polarized D	Polarized D	Polarized D	Polarized D	Rectangular & Polarized D	Circular	Circular
<b>RoHS</b>	Available	Available	Available	Available	No	Available	Available	Available	Available	Available
<b>Factory Terminated</b>	Yes*	Yes	Yes	Yes*	Yes	Yes*	Yes	Yes*	Yes	Yes
<b>Space Applications</b>	Available	Available	Available	Yes	Yes	Available	Available	Available	Yes	Yes
<b>Page Number</b>	7	18	22	23	25	28	32	39	44	44

	MIKQ	MT*	MEB	2D	CDL	CTA*	NDM	NTP	NJS
									
<b>Type</b>	Plug and Socket	Plug and Socket	Plug and Socket	Plug and Socket	Plug and Socket	Plug and Socket	Plug and Socket	Plug and Socket	Plug and Socket
<b>Current Rating</b>	3A max.	3A max.	3A max.	5A max.	5A max.	5A max.	1A max.	1A max.	1A max.
<b>Contact Resistance</b>	8 milliohms max.	8 milliohms max.	8 milliohms max.	9 milliohms max.	9 milliohms max.	9 milliohms max.	60 milliohms max.	60 milliohms max.	60 milliohms max.
<b>Contact Material</b>	gold plated copper alloy	gold plated copper alloy	gold plated copper alloy	gold plated copper alloy	gold plated copper alloy	gold plated copper alloy	precious metal alloy & gold plated copper alloy	precious metal alloy & gold plated copper alloy	precious metal alloy & gold plated copper alloy
<b>Shell</b>	Metal	Plastic	Plastic	Plastic	Plastic	Plastic	Metal	Plastic	Plastic
<b>Shell Material</b>	Steel	Thermoplastic	Thermoset	Thermoplastic	Thermoplastic	Thermoplastic	Thermoset	Thermoset	Thermoplastic
<b>Available Layouts</b>	7, 19 & 37	MTV - 1 thru 120 MTB - 1 thru 80	64, 128, 92 & 184	19, 31, 52, 79 & 100	139	CTA3 - 1 thru 53 CTA4 - 1 thru 60	9, 15, 21, 25, 31 & 37	1 thru 40	Rectangular - 9, 24 & 44 Circular - 27, 72 & 246
<b>Configuration</b>	Circular	Strip	Polarized D	Polarized D	Polarized D	Strip	Polarized D	Strip	Rectangular & Circular
<b>RoHS</b>	Available	Available	Available	Available	Yes	Yes	Yes	Yes	Yes
<b>Factory Terminated</b>	Yes	Yes*	Yes*	No	No	No	Yes	Yes	Yes
<b>Space Applications</b>	Yes	Yes	Yes	No	No	No	Yes	Yes	Yes
<b>Page Number</b>	44	48	54	59	65	66	72	71	73

\* Solderpot versions available for end user termination

Dimensions shown in inch (mm)  
Specifications and dimensions subject to change

www.ittcannon.com



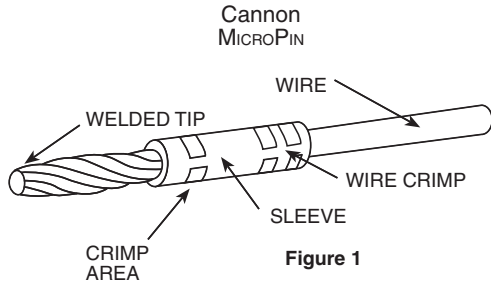


Figure 1

### Pos-A-Line Contact Alignment

The flexible twist-pin is recessed into the insulator and the rigid socket is exposed, reversing the traditional positions of pin and socket. During mating, the socket is guided into the pin insulator by the lead-in chamfer. The pin is kept from flexing beyond the socket capture radius by the walls of the cavity. The hemispherical weld of controlled radius at the tip of the pin combines with the lead-in chamfers of the socket contact and the pin insulator to cam the pin into alignment. By controlling the welding process and the dimensions of the socket contact and the insulators, it is impossible for the recessed pin to escape the socket capture radius.

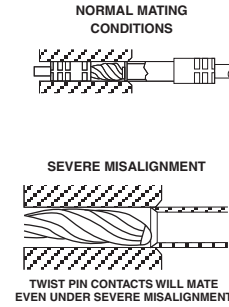


Figure 2

### Twist Pin Contact Technology

The foundation of ITT's Cannon Micro Connector portfolio starts with ITT's innovative twist pin contact system. This system was originally developed in the early 1960's and ITT was one of the original interconnect companies to license this technology and improve it. Our forty five years of experience in manufacturing and establishing a fully automated manufacturing system for this contact has truly given ITT the foremost knowledge in twist pin contact technology.

As the core of our micro products, the twist pin contact offers a superior electrical and mechanical system that outperforms traditional machined or stamped electrical contract systems. ITT's twist pin system consists of the Micro Socket and the Micro pin or Twist pin. Figure 1 show the basic contacts.

### Figure 1

The twist pin contact system consists of several stranded cores making up the wire bundle. The strands are subsequently heat treated and a weld is performed on the tip of each contact. Crimp sleeves are then inserted over the contact and crimp areas are defined to produce a seamless crimp system. The entire twist pin system is referred by ITT as a Pos-A-Line contact alignment system. Our reference to this system identifies that the flexible twist pin is recessed into the insulator and the rigid socket is exposed thus reversing the traditional positions of the pin and socket. During the mating sequence, the socket is guided into the pin insulator by the lead-in chamfer. The pin is kept from flexing beyond the socket capture radius by the walls of the cavity. The hemispherical weld of controlled radius at the tip of the pin combines with the lead-in chamfer of the socket contact and the pin insulator to cam the pin in alignment. ITT has developed a very robust Six Sigma manufacturing process that controls the welding process as well as the dimensions of the socket con-

tact and insulator material. The net result is a contact system that makes it impossible for the recessed pin to escape the socket capture radius. Figure 2 shows the twist pin features as well as mating and severe misalignment conditions.

The advantages of ITT's twist pin contact system are many and have been field proven in the most demanding applications and environments for over forty five years. Some of these advantages include:

- Seven points of electrical contact (Micro 0.050-inch & Centi Line 0.075-inch Interconnect Products)
- Five points of electrical contact (Nano 0.025-inch Interconnect Products)
- Contact and crimp sleeve materials carefully optimized for extremely reliable crimps- No design tradeoffs
- Seamless crimp sleeves
- Multiple 4-indent wire crimps standard and smaller bore micro socket contacts
- Standard integral tail & thru bundle micro pin contacts (high density packaging)
- High mating cycles
- High current handling capabilities
- System qualification in numerous Aerospace, Defense Electronic, and high temperature Geophysical applications.
- Wide array of wire terminations

The advantages listed above are by no means inclusive of ITT's innovative product improvement processes. Moving forward, ITT plans to introduce additional new product features supporting enhanced twist pin contact performance.





MDM connectors are used in applications requiring highly reliable, extremely small, lightweight connectors with higher density contact configurations than available in traditional rectangular connectors. They are available in 8 shell sizes accommodating from 9 to 100 contacts, and special arrangements of power and coaxial contacts.

These connectors are designed to meet the rapidly increasing demands for an environmental, high performance, rugged, moisture-sealed microminiature connector. This connector

employs size 24 MICROPIN™/MICROSOCKET™ contacts on .050 (1.27) centers in a contact density identical to the standard MICRO-D connector series, but with these additional features:

- Aluminum shells to provide greater strength, prevent chipping, cracking or breaking, offer electromagnetic (EMI) and RFI shielding.
- Silicone elastomer compression interfacial seal to provide a moisture and humidity seal between each contact and between contacts and shell.

## Specifications

### STANDARD MATERIALS AND FINISHES

Shell	- 6061-T6 Aluminum alloy per QQ-A-200/8, yellow chromate/cadmium, Type II, Class 3 over electroless nickel per SAE AMS-C-26074, Class 4.
Insulator	- Liquid Crystal Polymer per MIL-M-24519, Type GLCP-30F (9-100) - Glass filled diallyl phthalate per MIL-M-14, Type SDGF (7*2 and 24*4) - Polyphenylene sulfide per MIL-M-24519, Type GST-40F (16*5) - Polyester per MIL-M-24519, Type GPT-30F (10*10)
Contacts	- Copper alloy, gold plate
Mounting Hardware	- 300 Series stainless steel, passivate
Kit, Jackpost (3) items	- 300 Series stainless steel, passivate
Washer	- 400 Series stainless steel, passivate
Standard Epoxy	- Hysol EE4215/HD3561, color black or Hysol EE4198/HD3561, color green

### MECHANICAL FEATURES

Coupling	- Friction/jackscrews
Polarization	- Keystone-shaped shells
Contact Spacing Centers	- .050 (1.27)
Shell Styles	- Plug and receptacle
No. of Contacts	- 9 thru 100 signal; 5 signal/2 coaxial; 5 signal/2 power; 11 signal/5 coaxial; 11 signal/5 power; 0 signal/10 coaxial; 0 signal/10 power; 20 signal/4 coaxial; 20 signal/4 power
Coaxial Cable	- RG - 178/U
Wire Size	- #24 thru #32 AWG
Contact Termination	- Multiple indent crimp

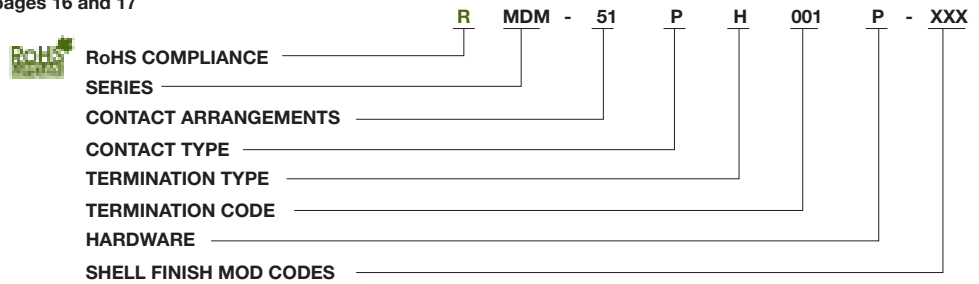
## Performance Data

The table below summarizes the results of key tests performed in accordance with MIL-STD-1344, where applicable. Data is applicable to standard connectors with standard termination. Variations may affect this data, so please consult customer service for further information on your requirements.

Test	Method	Criteria of Acceptance
Dielectric Withstanding Voltage	Method 3001: 600 VAC at sea level 150 VAC at 70,00' altitude	No breakdown No breakdown
Insulation Resistance	Method 3003	5,000 megohms minimum
Thermal Shock	Method 1003, Condition A: - 55°C to +125°C	No physical damage
Physical Shock	Method 2004, Condition E: 50 G's, 3 axes, 6 millisecond duration sawtooth pulse	No physical damage No loss of continuity > 1 µsec
Vibration	Method 2005, Condition IV: 20 G's, 10-2,000 Hz. 12 hrs	No physical damage No loss of continuity > 1 µsec
Durability	500 cycles of mating and unmating, 500 CPH max.	No mechanical or electrical defects
Moisture Resistance	Method 1002, Type II, omit steps 7a & 7b	Insulation resistance > 100 megohms
Salt Spray	Method 1001, Condition B: 48 hours	Shall be capable of mating and unmating, and meet contact resistance requirements
Contact Resistance (MIL-STD-202)	Method 1001, Condition B: At 3 amps At 1 milliamp	8 milliohms maximum 10 milliohms maximum
Contact Retention	Per MIL-DTL-83513	5 lb. minimum axial load

## How to Order

For MIL-DTL-83513 ordering information see pages 16 and 17



### SERIES

MDM: (Size 9-100) Liquid Crystal Polymer (LCP)  
MDM: (Combo Layout) Diallyl Phthalate (DAP)

### CONTACT ARRANGEMENTS

9-15-21-25-31-37-51-100 (standard)  
16C5, 10C10, 7C2, 24C4 (coaxial) } or combination of  
16P5, 10P10, 7P2, 24P4 (power) } coax and power

### CONTACT TYPE

P - Pin S - Socket

### TERMINATION TYPE

H - Harness-insulated wire.  
L - Solid-uninsulated wire.  
S - Solder pot to accept #26 AWG MAX.  
harness wire. (Not available with power  
contact arrangements.)

### HARDWARE

M - Military specification hardware, see  
page 11 for military hardware codes.  
P - Jackpost  
K - Jackscrew-standard profile  
L - Jackscrew-low profile  
F - Float mount  
B - No hardware standard  
.091 (2.31) dia. hole for sizes 9-51;  
.120 (3.05) dia. hole for size 100.  
A - .125 (3.18) dia. mounting holes for sizes 9-51;  
.166 (4.22) dia. hole for size 100.  
B1 - .1475 (3.75) dia. hole for size 100  
(Per MIL-DTL-83513)

### TERMINATION CODE\*

(H) 001 - 18", 7/34 strand, #26 AWG,  
MIL-W-16878/4, Type E Teflon, yellow.  
(H) 003 - 18", 7/34 strand, #26 AWG,  
MIL-W-16878/4, Type E Teflon,  
color coded to MIL-STD-681 System I.  
(L) 1 - 1/2" uninsulated solid #25  
AWG gold plated copper.  
(L) 2 - 1" uninsulated solid #25 AWG  
gold plated copper.

### SHELL FINISH MOD CODES

No Number - (Standard cadmium/yellow  
chromate over nickel  
A174 - Electroless nickel  
A172 - Gold over nickel  
A141 - Irridite/alodine  
A30 - Black anodize

\*See page 79 and 81 for additional Termination codes.

COTS or Non Mil-Spec or Commercial or Industrial Standard Wire Termination Codes

Cannon Modification Code (Not MS)

The following termination codes are listed for your information. For additional codes please refer to Appendix on page 79 and 81. **All wire lengths are minimum.**

### Harness Type (H)

#26 AWG per MIL-W-16878/4, 7/34 strand, type E Teflon, stranded.

Length	All Yellow	Color Coded*
3 (76.2)	H020	H027
6 (152.4)	H019	H016
8 (203.2)	H026	H034
10 (254.0)	H029	H025
12 (304.8)	H028	H002
18 (457.2)	H001	H003
20 (508.0)	H038	H023
24 (609.6)	H009	H004
30 (762.0)	H010	H005
36 (914.4)	H011	H006
48 (1219.2)	H013	H048
72 (1828.8)	H017	H046
120 (3048.0)	H042	H041

\* Cavity #1 black

### Solid Uninsulated Type (L)

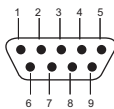
#25 AWG gold plated copper

Termination Code	Length
L61	.125 (3.18)
L56	.150 (3.81)
L57	.190 (4.83)
L39	.250 (6.35)
L58	.375 (9.52)
L1	.500 (12.70)
L14	.750 (19.05)
L2	1.000 (25.40)
L7	1.500 (38.10)
L6	2.000 (50.80)
L16	2.500 (63.50)
L10	3.000 (76.20)

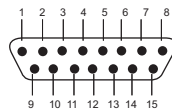
## Contact Arrangements

(Face View of Pin insert - Use Reverse Order for Socket Side)

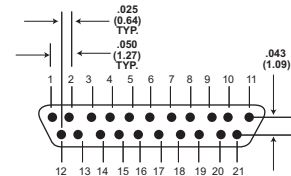
### Standard



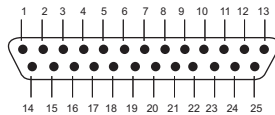
9 Contacts



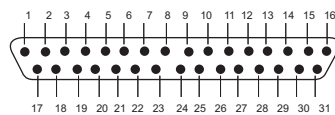
15 Contacts



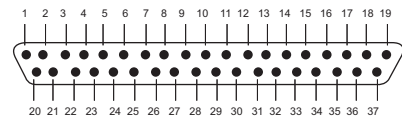
21 Contacts



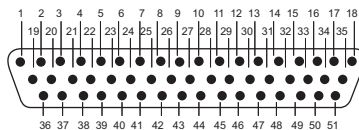
25 Contacts



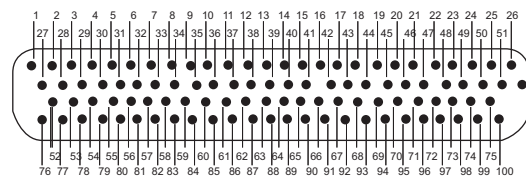
31 Contacts



37 Contacts

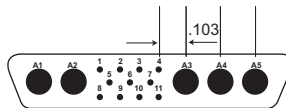


51 Contacts

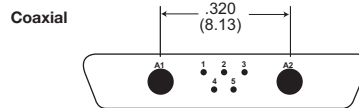


100 Contacts

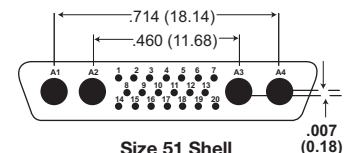
Contact identification numbers are for reference only and do not appear on insulator or connector body.



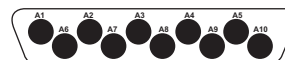
Size 51 Shell  
11 Micro contact  
5 Coax or 5 Power



Size 25 Shell  
5 Micro contact  
2 Coax or 2 Power



Size 51 Shell  
20 Micro contacts  
4 Coax or 4 Power  
(Not MS)



Size 100 Shell  
10 Micro contact  
10 Coax or 10 Power

Dimensions shown in inch (mm)

Specifications and dimensions subject to change

www.ittcannon.com

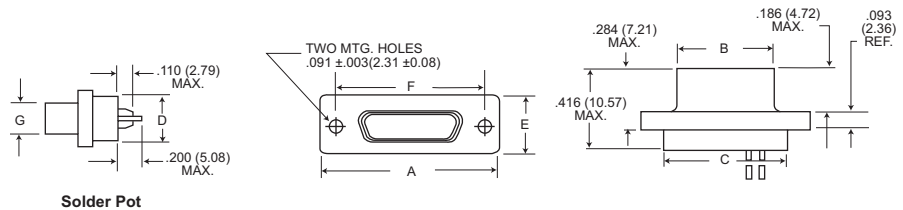


# Micro-D Metal Shell - .050" Contact Spacing

MDM

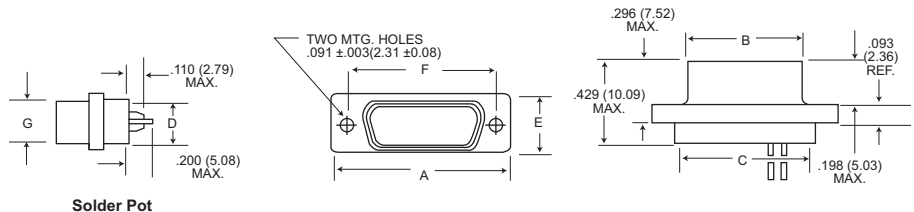
COTS or Non Mil-Spec or Commercial or Industrial Shell Dimensions (Conforms to MIL-DTL-83513)

## Plug



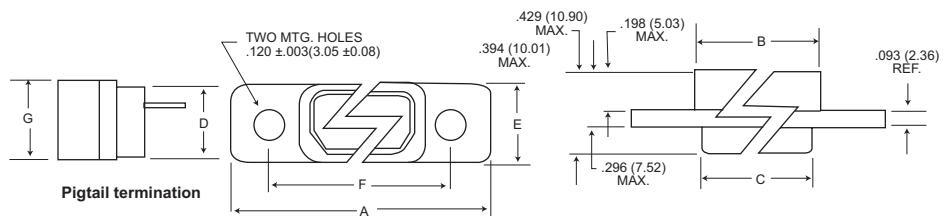
Solder Pot

## Receptacle



Solder Pot

## Receptacle (MDM-100 only)



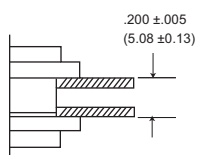
Pigtail termination

Part Number By Shell Size	A Max.	B Max.	C Max.	D Max.	E Max.	F + .005 (0.13)	G Max.	Average Weights** oz. (gm.) ±5%
MDM-9P*	.785 (19.94)	.334 (8.48)	.400 (10.16)	.270 (6.86)	.308 (7.82)	.565 (14.35)	.185 (4.70)	.063 (1.79)
MDM-9S*	.785 (19.94)	.402 (10.21)	.400 (10.16)	.270 (6.86)	.308 (7.82)	.565 (14.35)	.253 (6.43)	.063 (1.79)
MDM-15P*	.935 (23.75)	.484 (12.29)	.550 (13.97)	.270 (6.86)	.308 (7.82)	.715 (18.16)	.185 (4.70)	.084 (2.39)
MDM-15S*	.935 (23.75)	.552 (13.97)	.550 (13.97)	.270 (6.86)	.308 (7.82)	.715 (18.16)	.253 (6.43)	.083 (2.37)
MDM-21P*	1.085 (27.56)	.634 (16.10)	.700 (17.78)	.270 (6.86)	.308 (7.82)	.865 (21.97)	.185 (4.70)	.105 (2.99)
MDM-21S*	1.085 (27.56)	.702 (17.83)	.700 (17.78)	.270 (6.86)	.308 (7.82)	.865 (21.97)	.253 (6.43)	.104 (2.97)
MDM-25P*	1.185 (30.10)	.734 (18.64)	.800 (20.32)	.270 (6.86)	.308 (7.82)	.965 (24.51)	.185 (4.70)	.119 (3.39)
MDM-25S*	1.185 (30.10)	.802 (20.37)	.800 (20.32)	.270 (6.86)	.308 (7.82)	.965 (24.51)	.253 (6.43)	.118 (3.36)
MDM-31P*	1.335 (33.91)	.884 (22.45)	.950 (24.13)	.270 (6.86)	.308 (7.82)	1.115 (28.32)	.185 (4.70)	.140 (3.99)
MDM-31S*	1.335 (33.91)	.952 (24.18)	.950 (24.13)	.270 (6.86)	.308 (7.82)	1.115 (28.32)	.253 (6.43)	.139 (3.96)
MDM-37P*	1.485 (37.72)	1.034 (26.26)	1.100 (27.94)	.270 (6.86)	.308 (7.82)	1.265 (32.13)	.185 (4.70)	.161 (4.59)
MDM-37S*	1.485 (37.72)	1.102 (27.99)	1.100 (27.94)	.270 (6.86)	.308 (7.82)	1.265 (32.13)	.253 (6.43)	.160 (4.56)
MDM-51P*	1.435 (36.45)	.984 (24.99)	1.050 (26.67)	.310 (7.87)	.351 (8.92)	1.215 (30.86)	.228 (5.79)	.193 (5.50)
MDM-51S*	1.435 (36.45)	1.052 (26.72)	1.050 (26.67)	.310 (7.87)	.351 (8.92)	1.215 (30.86)	.296 (7.52)	.188 (5.35)
MDM-100P*	2.170 (55.12)	1.384 (35.15)	1.442 (36.63)	.360 (9.14)	.394 (10.01)	1.800 (45.72)	.271 (6.88)	.500 (14.3)
MDM-100S*	2.170 (55.12)	1.508 (38.10)	1.442 (36.63)	.360 (9.14)	.394 (10.01)	1.800 (45.72)	.394 (10.01)	1.040 (29.5)

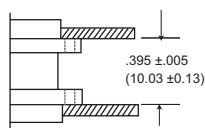
\*Add lead type and length; see How To Order.

\*\*\*Weight given is 1/2", insulated, solid, #25 AWG gold plated copper pigtails.

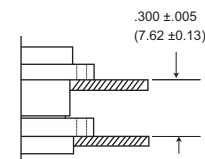
## Panel Mounting Dimensions (Sizes 9 - 100)



Plug and Receptacle  
Rear Mounted



Plug and Receptacle  
Front Mounted



Plug Front Mounted  
Receptacle Rear Mounted



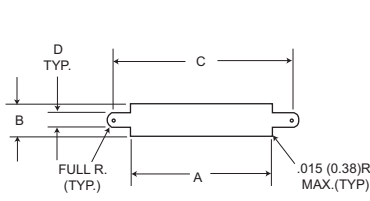
Dimensions shown in inch (mm)  
Specifications and dimensions subject to change

www.ittcannon.com

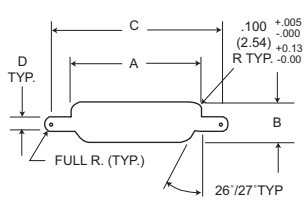
## Panel Cutouts

NOTE: See page 13 for rear panel mounting configuration.

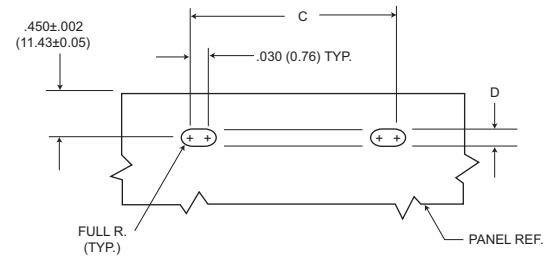
### Shell Sizes 9 thru 51



**Figure 1**  
Front Mounting

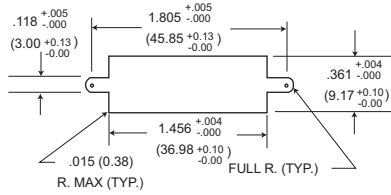


**Figure 2**  
Rear Mounting

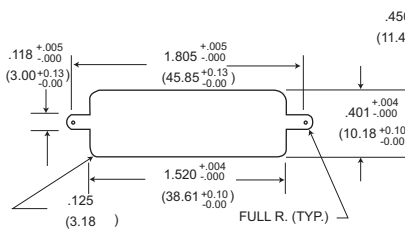


**Figure 3**  
Edgeboard Mounting

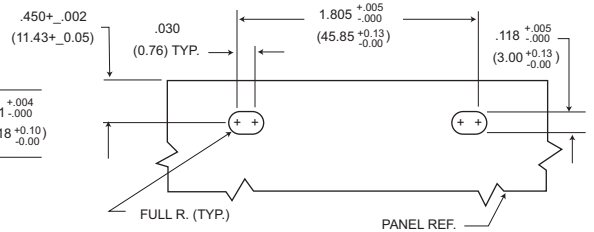
### Shell Size 100



**Figure 1**  
Front Mounting



**Figure 2**  
Rear Mounting



**Figure 3**  
Edgeboard Mounting

### For 9-51 Shell Sizes

#### NOTES:

1. Front panel mounting is the preferred mounting method. Front panel mounting dimensions (figure 1) will accommodate either #2-56 screws or jackpost hardware.
2. Rear panel mount dimensions (figure 2) will accommodate #2-56 screw hardware only. When mounting the connector with rear panel mount jackpost see the panel cut-out dimensions.
3. Edgeboard mounting bracket (figure 3) uses #2-56 screws. Dimension .450+/-0.002 (11.43+/-0.05) locates the MDM receptacle flush with the end of the board.

### For 100 Shell Size

#### NOTES:

1. Front mounting is the preferred mounting method. Front panel mounting dimensions (figure 1) will accommodate either #4-40 screws or jackpost hardware.
2. Rear panel mount dimensions (figure 2) will accommodate #4-40 screw hardware only see the panel cut-out dimensions.
3. Edgeboard mounting bracket (figure 3) uses #4-40 screws. Dimension .450+/-0.002 (11.43+/-0.05) locates the MDM receptacle flush with the end of the board.

Shell Size	Cutout Figure	A +.004 -.000	B +.004 -.000	C +.005 -.000	D +.005 -.000
9	1	.408	.271	.570	.089
	2	.401	.252	.570	.089
	3	-	-	.570	.089
15	1	.558	.271	.720	.089
	2	.551	.252	.720	.089
	3	-	-	.720	.089
21	1	.708	.271	.870	.089
	2	.701	.252	.870	.089
	3	-	-	.870	.089
25	1	.808	.271	.970	.089
	2	.801	.252	.970	.089
	3	-	-	.970	.089
31	1	.958	.271	1.120	.089
	2	.951	.252	1.120	.089
	3	-	-	1.120	.089
37	1	1.108	.271	1.270	.089
	2	1.101	.252	1.270	.089
	3	-	-	1.270	.089
51	1	1.058	.315	1.220	.089
	2	1.051	.295	1.220	.089
	3	-	-	1.220	.089

Dimensions shown in inch (mm)

Specifications and dimensions subject to change

www.ittcannon.com



## Mounting Hardware Views (for sizes 9-51)

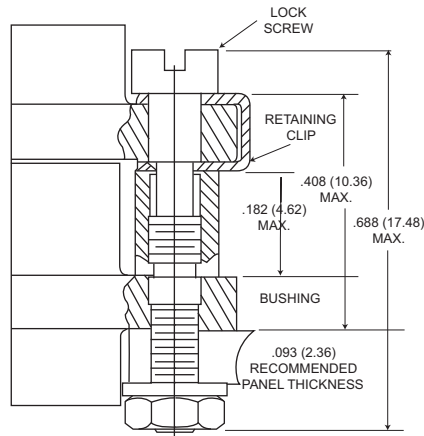
This hardware supplied unassembled.



**Screw Lock Assembly**

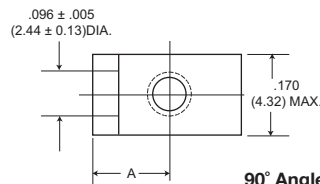


**90° Angle Mounting Bracket**

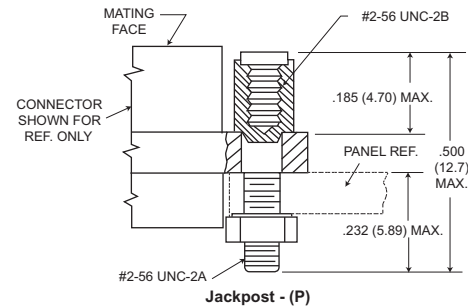


**Screw Lock Assembly\***

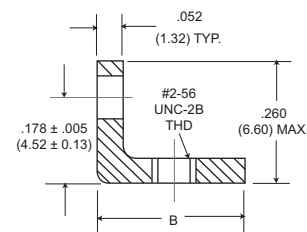
\*NOTE Torque value is 2.5 in/lbs max.



**90° Angle Mounting Bracket**



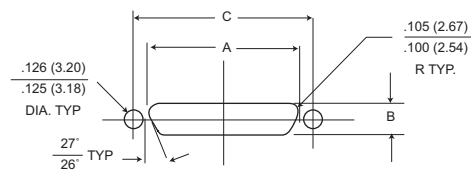
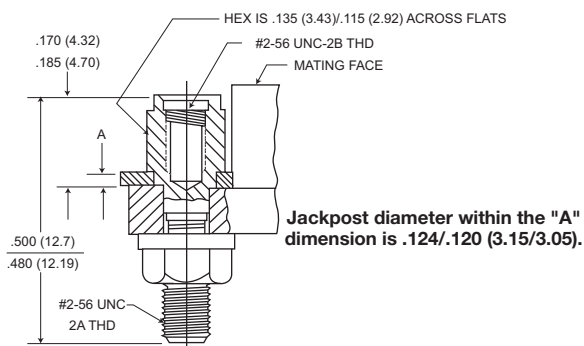
**Jackpost - (P)**



Description	Part Number	A	
		+/- .005 (±0.13)	B Max.
Screw Lock Assembly	322-9500-000		N/A
Jackpost kit	320-9505-000		N/A
Mounting Bracket 90° MDM for 9 thru 37 Shell Sizes	015-9516-002	.147 (3.73)	.308 (7.82)
Mounting Bracket 90° MDM for 51 Shell Size	015-9516-003	.169 (4.29)	.350 (8.89)

NOTES: Screw lock assembly (322-9500-000) can be used for front mounting only. Jackpost kit (320-9505-000) consists of two assemblies, shipped unassembled.

## Jackpost Bushing (for rear panel mounting-for sizes 9-51)



### Plug and Receptacle Dimensions

Shell Size	A		B		C
	+ .004 (0.10)	- .000 (0.00)	+ .004 (0.10)	- .000 (0.00)	
9	.401 (10.19)		.252 (6.40)		.565 (14.35)
15	.551 (14.00)		.252 (6.40)		.715 (18.16)
21	.701 (17.81)		.252 (6.40)		.865 (21.97)
25	.801 (20.34)		.252 (6.40)		.965 (24.51)
31	.951 (24.16)		.252 (6.40)		1.115 (28.34)
37	1.101 (27.97)		.252 (6.40)		1.265 (32.13)
51	1.051 (26.70)		.295 (7.49)		1.215 (30.86)

Panel A Thickness	A		Jackpost Kit Number*
	+ .005 (0.13)	- .000 (0.00)	
3/32 (2.4)	.087 (2.21)		320-9505-007
1/16 (1.6)	.056 (1.42)		320-9505-006
3/64 (1.2)	.042 (1.07)		320-9505-005
1/32 (0.8)	.025 (0.64)		320-9505-004

\*A kit consists of 2 jackpost, 2 nuts, 2 washers.

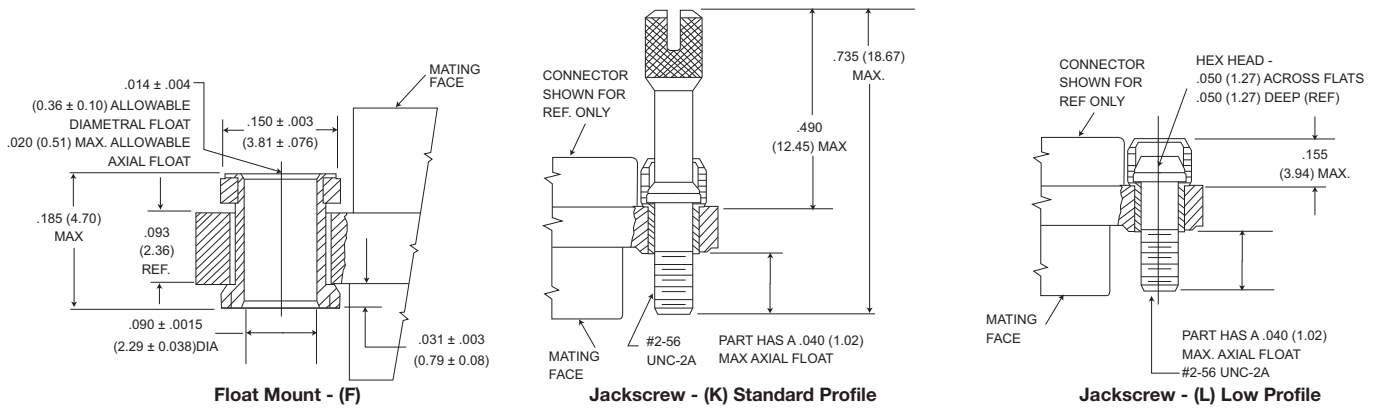


Dimensions shown in inch (mm)  
Specifications and dimensions subject to change

www.ittcannon.com

## Mounting Hardware Views (sizes 9-51)

This hardware is factory installed.

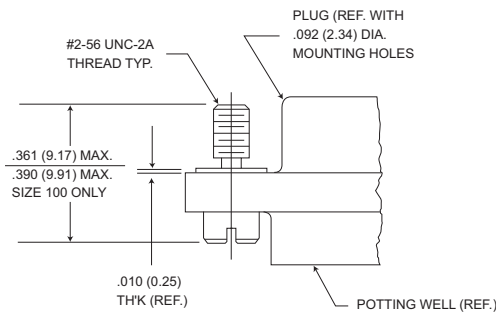


Shown here is a cutaway view of the float mount for the MDM connector. The basic shell dimensions are the same for the float mount and the screw mounting hole configurations. View shown is for standard float mount front panel mounting. Reverse mounting is available on request.

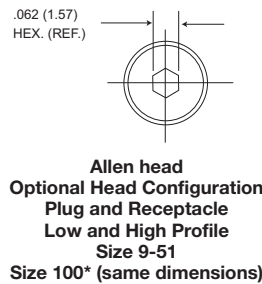
\* NOTE: Torque values are as follows:  
 Low Profile Jackscrew (L)-2.5 in-lbs  
 Standard Jackscrew (K)-2.5 in-lbs

## Mounting Hardware to Military Specification (for sizes 9 - 100) per MIL-DTL-83513/5

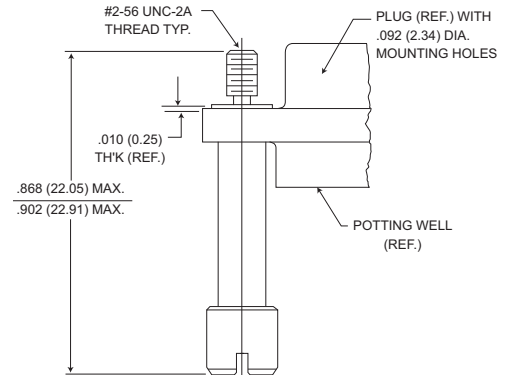
This hardware supplied in kits unassembled (2 pieces of each item).



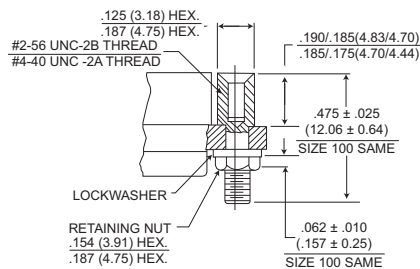
**Figure 1. Jackscrew - Low profile Slotted Head Size 9-51 Size 100\***



**Allen head Optional Head Configuration Plug and Receptacle Low and High Profile Size 9-51 Size 100\* (same dimensions)**



**Figure 2. Jackscrew - High Profile Slotted Head Size 9-51 Size 100\***



**Figure 3. Jackpost Assembly Size 9-51 Size 100\***

To order hardware kits separately, order either by M83513/5-\*\* or by 320-950X-XXX.

Description	Size 9-51		Size 100*	
	Mod Code	Part Number	Mod Code	Part Number
Slotted Head Jackscrew Assy Low Profile (Figure 1)	M5	320-9508-025	05	M15 320-9508-021
Slotted Head Jackscrew Assy Low Profile (Figure 2)	M6	320-9508-027	06	M16 320-9508-023
Allen Head Jackscrew Assy Low Profile (Figure 1)	M2	320-9508-026	02	M12 320-9508-022
Allen Head Jackscrew Assy High Profile (Figure 2)	M3	320-9508-028	03	M13 320-9508-024
Jackpost Assy (Figure 3)	M7	320-9505-033	07	M17 320-9505-030

\*Size 100 requires B1 size mounting holes for Mil-Spec hardware

Note: Torque values as follows:

- Size 9-51 4.0 in-lbs
- Size 100 6.0 in-lbs

Dimensions shown in inch (mm)

Specifications and dimensions subject to change

www.ittcannon.com



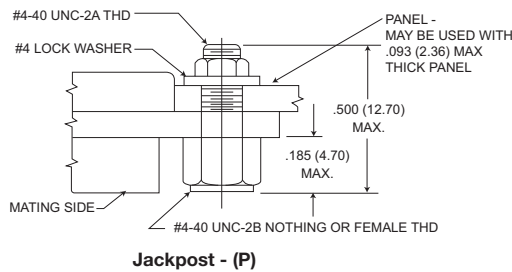
## Mounting Hardware Views (for size 100)

This hardware supplied unassembled.

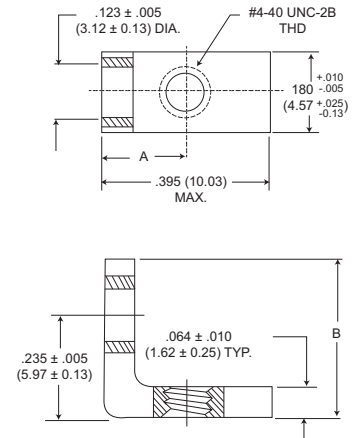


**90° Angle Mounting Bracket**

Note: Size 100 requires .120 dia (B) mounting hole when using Commercial (P) jackpost kits.



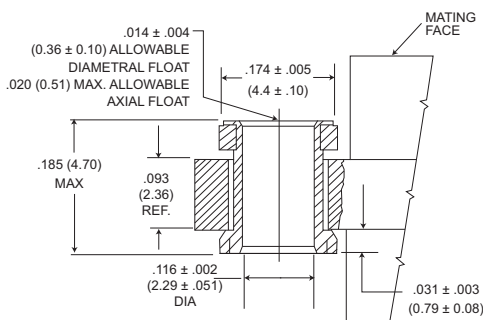
**Jackpost - (P)**



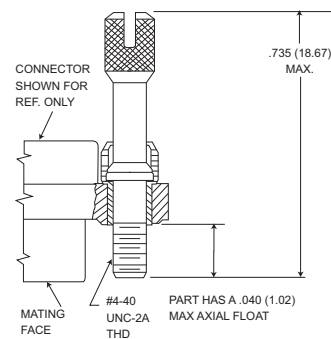
**90° Angle Mounting Bracket**

Description	Part Number	A ± .005 (0.13)	B Max.
Jackpost kit	320-9505-015	N/A	
Mounting Bracket 90° MDM	015-9528-000	.191 (4.85)	.370 (9.40)

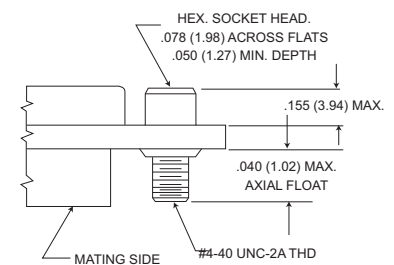
This hardware is factory installed.



**Float Mount - (F) Std.**



**Jackscrew - (K) Standard**



**Jackscrew - (L) (Low Profile)**

\*NOTE: Torque values are as follows:  
Low Profile Jackscrew (L)-4.0 in-lbs  
Standard Profile Jackscrew (K)-4.0 in-lbs

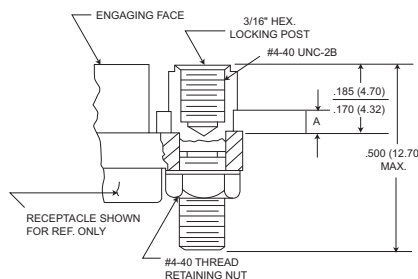
## Jackpost Bushing (for Rear Panel Mounting)

Panel Thickness	A + .005 (0.13) - .000 (0.00)	Jackpost Kit Number*
3/32 (2.4)	.087 (2.21)	320-9505-013
1/16 (1.6)	.058 (1.42)	320-9505-012
1/32 (0.8)	.025 (0.64)	320-9505-010
3/64 (1.2)	.042 (1.07)	320-9505-011

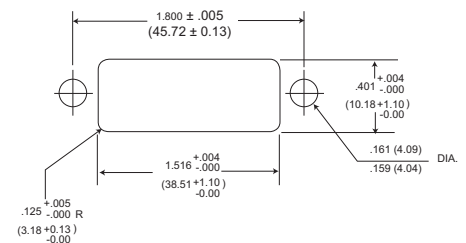
\*2 jackposts, 2 nuts, 2 washers

Torque value for size 100

Note: Size 100 requires B mounting hole shell size when using rear panel mount jackposts



### Dimensions for Rear Panel Mounting



Dimensions shown in inch (mm)  
Specifications and dimensions subject to change

www.ittcannon.com

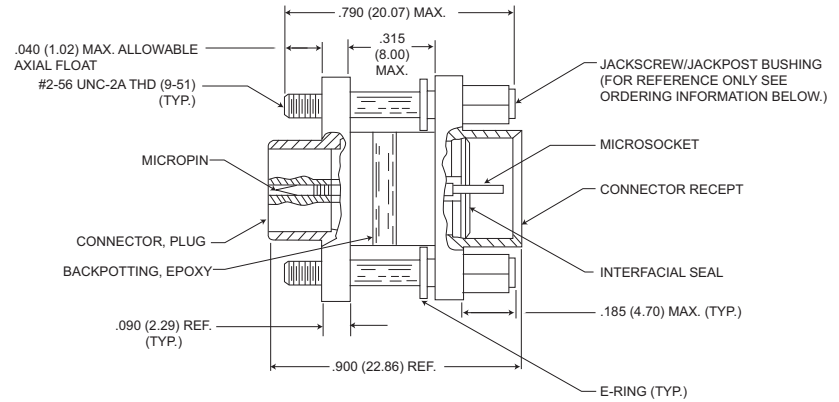
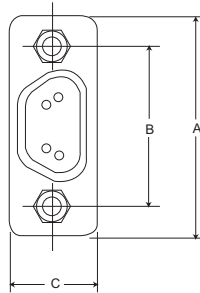
## Connector Saver



Save wear and tear on your equipment and systems connectors by using the "Connector Saver".

The multi-matings and unmatings experienced by most connectors during testing and final check out can be eliminated.

Simply mate the "Connectors Saver" to your unit and use the opposite side for your testing interface...less wear, less tear, less chance of damage. It is available in all eight standard MDM layouts. Mating hardware is available and can be ordered either separately or included with the connector saver.



MDM Size 9 Shown

Size	Electroless Nickel (A174) Plated		Cadmium over Nickel (A101) Plated		*Hardware Kits	A Max.	B ± .005 (0.13)	C Max.
	With Hardware	W/O Hardware	With Hardware	W/O Hardware				
9	MDM98479-86	MDM98479-18	MDM98479-78	MDM-97294-371	320-9505-014**	.785 (19.94)	.565 (14.35)	.308 (7.82)
15	MDM98479-87	MDM98479-19	MDM98479-79	MDM-97294-372	320-9505-014**	.935 (23.75)	.715 (18.16)	.308 (7.82)
21	MDM98479-88	MDM98479-20	MDM98479-80	MDM-97294-373	320-9505-014**	1.085 (27.56)	.865 (21.97)	.308 (7.82)
25	MDM98479-89	MDM98479-21	MDM98479-81	MDM-97294-374	320-9505-014**	1.185 (30.10)	.965 (24.51)	.308 (7.82)
31	MDM98479-90	MDM98479-14	MDM98479-82	MDM-97294-375	320-9505-014**	1.335 (33.91)	1.115 (28.32)	.308 (7.82)
37	MDM98479-91	MDM98479-15	MDM98479-83	MDM-97294-376	320-9505-014**	1.485 (37.72)	1.265 (32.13)	.308 (7.82)
51	MDM98479-92	MDM98479-16	MDM98479-84	MDM-97294-377	320-9505-014**	1.435 (36.45)	1.215 (30.86)	.351 (8.91)
100	MDM98479-93	MDM98479-17	MDM98479-85	MDM-97294-717	320-9508-014***	2.170 (55.12)	1.800 (45.72)	.394 (10.01)

\* Kit contains 2 jackpost/jackscrew bushings and 2 E-Rings.

\*\* Size 9-51-#2-56 UNC-2B Thread

\*\*\* Size 100-#4-40 UNC-2B Thread

Dimensions shown in inch (mm)  
Specifications and dimensions subject to change

www.ittcannon.com



M83513/ 01 - H100 - \*\* \*\*\*\*

### SERIES

- MDM - Metal Shell, Liquid Crystal Polymer (LCP)
- MDB - Diallyl Phthalate Insulator
- MDVB - Polyester Insulator
- 

### MIL-C-83513 SLASH SHEET

- |  |                        |
|--|------------------------|
| 01 - Plug, Connector, Solderpot        | } Metal Shell          |
| 02 - Receptacle, Connector, Solderpot  |                        |
| 03 - Plug, Connector, Crimp Type       |                        |
| 04 - Receptacle, Connector, Crimp Type |                        |
| 05 - Hardware Only <sup>△</sup>        |                        |
| 06 - Plug, Connector, Solderpot        | } Plastic <sup>△</sup> |
| 07 - Receptacle, Connector, Solderpot  |                        |
| 08 - Plug, Connector, Crimp Type       |                        |
| 09 - Receptacle, Connector, Crimp Type |                        |

### INSERT ARRANGEMENT

	<u>METAL SHELL</u>	<u>PLASTIC</u>
A -	9 Contact	9 Contact
B -	15 Contact	15 Contact
C -	21 Contact	21 Contact
D -	25 Contact	25 Contact
E -	31 Contact	31 Contact
F -	37 Contact	37 Contact
G -	51 Contact	51 Contact
H -	100 Contact	_____ <sup>△</sup>

### WIRE TYPE

- No Number - For Solderpot
- 01 - 18" long, #26 AWG per MIL-W-22759/11-26-9 (all white)
  - 02 - 36" long, #26 AWG per MIL-W-22759/11-26-9 (all white)
  - 03 - 18" long, #26 AWG per MIL-W-22759/11-26  
Color Coded per MIL-STD-681, System 1, 10 colors repeating <sup>△</sup>
  - 04 - 36" long, #26 AWG per MIL-W-22759/11-26-  
Color Coded per MIL-STD-681, System 1, 10 colors repeating <sup>△</sup>
  - 05 - .5" long, #25 AWG, type S per QQ-W-343,  
Gold Plated
  - 06 - 1.0" long, #25 AWG, type S per QQ-W-343,  
Gold Plated
  - 07 - .5" long, #25 AWG, type S per QQ-W-W-343,  
Tin Plated
  - 08 - 1.0" long, #25 AWG, type S per QQ-W-343,  
Tin Plated
  - 09 - 18" long, #26 AWG per MIL-W-22759/33-26-9 (all white) <sup>△</sup>
  - 10 - 36" long, #26 AWG per MIL-W-22759/33-26-9 (all white) <sup>△</sup>
  - 11 - 18" long, #26 AWG per MIL-W-22759/33-26  
Color Coded per MIL-STD-681, System 1, 10 colors repeating <sup>△</sup> <sup>△</sup>
  - 12 - 36" long, #26 AWG per MIL-W-22759/33-26  
Color Coded per MIL-STD-681, System 1, 10 colors repeating <sup>△</sup> <sup>△</sup>
  - 13 - 72" long, #26 AWG per MIL-W-22759/11-26-9 (all white) <sup>△</sup> <sup>△</sup>
  - 14 - 72" long, #26 AWG per MIL-W-22759/11-26  
Color Coded per MIL-STD-681, System 1, 10 colors repeating <sup>△</sup>
  - 15 - 72" long, #26 AWG per MIL-W-22759/33-26-9 (all white) <sup>△</sup>
  - 16 - 72" long, #26 AWG per MIL-W-22759/33-26  
Color Coded per MIL-STD-681, System 1, 10 colors repeating <sup>△</sup> <sup>△</sup>

### NOTES:

- <sup>1</sup> - For every Mil Spec Part Number, ITT has one corresponding part number shown an example
- <sup>△</sup> - Tolerance on wire lengths: 18", 36" and 72" long – +1.00"/-0.00" .5" and 1.00" – +.200"/-.000"
- <sup>△</sup> - For space application, connector shell finish must be "A174" and wire must be per MIL-W-22759/33-26.
- 4 - Any deviations to these P/N's will result in assignment of a special P/N, consult factory.
- <sup>△</sup> - Size 100 not available in / 06 through / 09. (Plastic shell)
- <sup>△</sup> - Color coding in accordance with MIL-STD-681, System 1, no parenthesis. See page 83 for color code chart.
- <sup>△</sup> - For mounting hardware to Military Specification (sizes 9 to 100) see page 13.

### SHELL FINISH

- No number - for plastic type connector
- C – for Cadmium/Yellow chromate over nickel
- N – A174 - Electroless Nickel A174 <sup>△</sup>



M83513/ 10 - A \*\* C \*

**SERIES**

Connector, Electrical, Rectangular  
 Microminiature, Polarized Shell  
 PC Board Mounting

**MIL-C-83513 SLASH SHEET**


- 10 - Connector, Plug, Condensed Board Right Angle (CBR), Sizes 9 – 37
- 11 - Connector, Plug, CBR, Size 51
- 12 - Connector, Plug, CBR, Size 100
- 13 - Connector, Receptacle, CBR, Sizes 9 – 37
- 14 - Connector, Receptacle, CBR Size 51
- 15 - Connector, Receptacle, CBR, Size 100
- 16 - Connector, Plug, Board Right Angle (BR), Sizes 9 – 37
- 17 - Connector, Plug, BR, Size 51
- 18 - Connector, Plug, BR, Size 100
- 19 - Connector, Receptacle, BR, Sizes 9 – 37
- 20 - Connector, Receptacle, BR Size 51
- 21 - Connector, Receptacle, BR Size 100
- 22 - Connector, Plug, Board Straight (BS), Sizes 9 – 37
- 23 - Connector, Plug, BS, Size 51
- 24 - Connector, Plug, BS, Size 100
- 25 - Connector, Receptacle, BS, Sizes 9 – 37
- 26 - Connector, Receptacle, BS, Size 51
- 27 - Connector, Receptacle, BS Size 100

**INSERT ARRANGEMENT**



METAL SHELL

- A - 9 Contact
- B - 15 Contact
- C - 21 Contact
- D - 25 Contact
- E - 31 Contact
- F - 37 Contact
- G - 51 Contact
- H - 100 Contact



**WIRE TYPE**

- No Number - For Solderpot
- 01 - .109" long, #24 AWG solid copper wire per QQ-W-343, Type "S", solder dipped
- 02 - .140" long, #24 AWG solid copper wire per QQ-W-343, Type "S", solder dipped 
- 03 - .172" long, #24 AWG solid copper wire per QQ-W-343, Type "S", solder dipped

**NOTES:**

- 1 - For every Mil Spec Part Number, ITT has one corresponding part number
-  - Tolerance on wire lengths ±.015
-  - For space application, connector shell finish must be "N".
- 4 - Any deviations to these P/N's will result in assignment of a special P/N, consult customer service.

**SHELL FINISH**

- No letter - for plastic type connector
- C - Cadmium / Yellow chromate over nickel
- N - Electroless Nickel  

**HARDWARE**

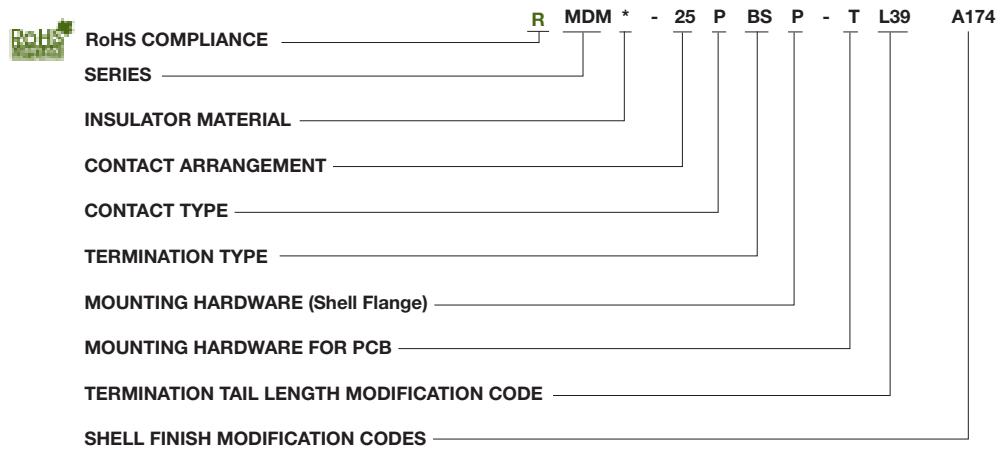
- N - No jackpost
- P - Jackpost (permanently attached)
- T - Threaded insert



MDM-PCB connectors are designed for use with flex circuitry, flat cable and printed circuit boards or multi-layer boards. They use the standard MDM metal shell and provide high density and high reliability in board-to-board, board-to-cable and cable-to-cable applications.

MDM-PCB connectors are available in 8 shell sizes with 9 to 100 contacts. Terminations may be straight (BS) or at 90° right angle (BR, CBR) board thickness. Jackpost mounting for use with locking hardware is also available.

## How to Order - MDM-PCB Series



- SERIES**  
MDM - Micro "D" Metal Shell
- INSULATOR MATERIAL**  
Liquid Crystal Polymer (LCP)
- CONTACT ARRANGEMENT**  
9, 15, 21, 25, 31, 37, 51, and 100
- CONTACT TYPE**  
P - Pin (Plug)  
S - Socket (Receptacle)

- TERMINATION TYPE**  
BS - Straight PCB Termination  
BR - Right Angle PCB Termination  
CBR - Right Angle Narrow Profile PCB Terminations
- MOUNTING HARDWARE (Shell Flange)**  
P - Jackposts  
M7 - Jackposts  
M83513/5-07 (Sizes 9-51)  
M17 - Jackposts  
M83513/5-17 (Size 100)  
No letter - none

- MOUNTING HARDWARE FOR PCB**  
T - Threaded Insert  
#2-56 Thd for Shell Sizes 9 thru 51  
#4-40 Thd for Shell Size 100  
No letter - none

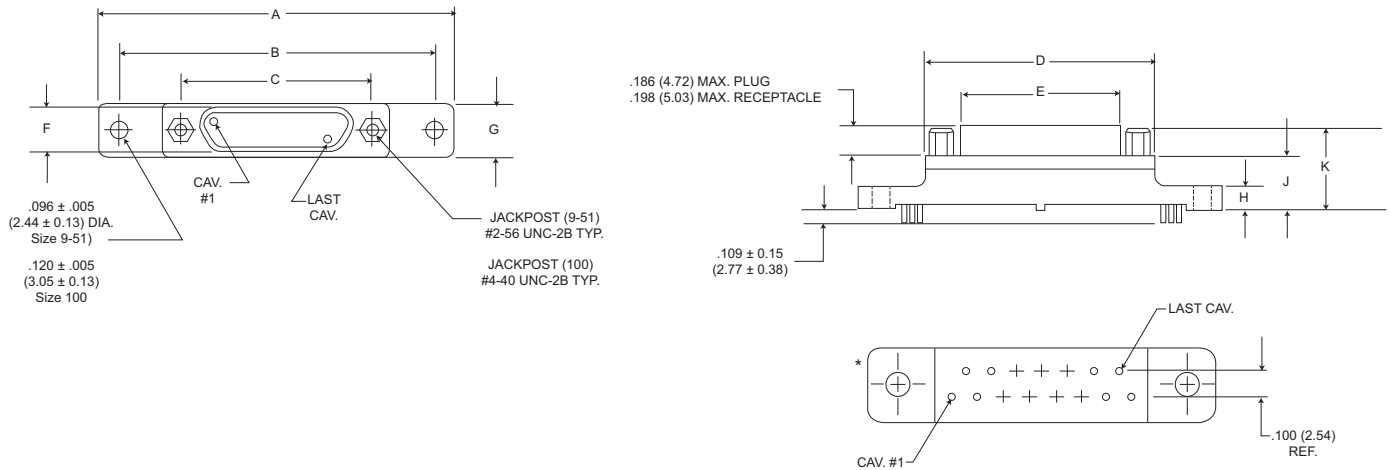
- TERMINATION TAIL LENGTH MODIFICATION CODE**  
None - .109 (2.77) ±.015 (0.38) Standard  
L61 - .125 (3.18)  
L56 - .150 (3.81)  
L57 - .190 (4.83)  
L39 - .250 (6.35)  
L58 - .375 (9.52)

- SHELL FINISH MODIFICATION CODES**  
None - Yellow Chromate/Cadmium over Nickel  
A174 - Electroless Nickel  
A172 - Gold over Nickel  
A141 - Iridite/Alodine  
A30 - Black Anodize  
(For special modification codes, consult customer service.)

NOTE: Back molding material - Epoxy Hysol #MG40FS



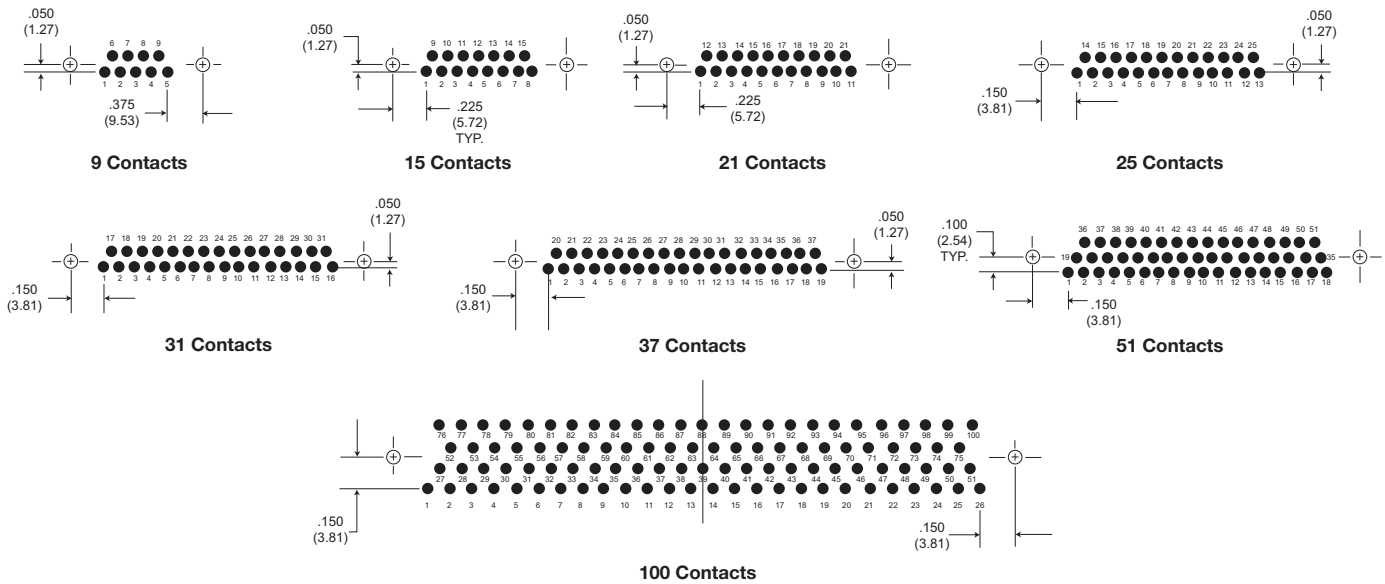
## BS (Board Straight) Series



### PCB Termination Arrangements\* (Viewed from PCB solder side)

Identification number shown for plug connector, use reverse order for socket connector.

NOTE: Dimensions shown are for reference only-consult factory for final design dimensions.



NOTE: Standard lead termination is #24 AWG, solid copper, solder or tin dipped

All Termination Configurations .100 (2.54) x .100 (2.54) Grid Pattern, Offset .050 (1.27)

Part Number By Shell Size	A	B	C	D	E	F	G	H	J	K
	Max.	±.007 (.18)	±.005 (.13)	Max.	Max.	Max.	Max.	Max.	Max.	Max.
MDM-9PBS*	1.390 (35.31)	1.150 (29.21)	.565 (14.35)	.785 (19.94)	.334 (8.48)	.185 (4.70)	.308 (7.82)	.165 (4.19)	.355 (9.02)	.555 (14.10)
MDM-9SBS*	1.390 (35.31)	1.150 (29.21)	.565 (14.35)	.785 (19.94)	.402 (10.21)	.253 (6.43)	.308 (7.82)	.165 (4.19)	.355 (9.02)	.555 (14.10)
MDM-15PBS*	1.390 (35.31)	1.150 (29.21)	.715 (18.16)	.935 (23.75)	.484 (12.29)	.185 (4.70)	.308 (7.82)	.165 (4.19)	.355 (9.02)	.555 (14.10)
MDM-15SBS*	1.390 (35.31)	1.150 (29.21)	.715 (18.16)	.935 (23.75)	.552 (13.97)	.253 (6.43)	.308 (7.82)	.165 (4.19)	.355 (9.02)	.555 (14.10)
MDM-21PBS*	1.690 (43.93)	1.450 (36.83)	.865 (21.97)	1.085 (27.56)	.634 (16.10)	.185 (4.70)	.308 (7.82)	.165 (4.19)	.355 (9.02)	.555 (14.10)
MDM-21SBS*	1.690 (43.93)	1.450 (36.83)	.865 (21.97)	1.085 (27.56)	.702 (17.83)	.253 (6.43)	.308 (7.82)	.165 (4.19)	.355 (9.02)	.555 (14.10)
MDM-25PBS	1.740 (44.20)	1.500 (38.10)	.965 (24.51)	1.185 (30.10)	.734 (18.64)	.185 (4.70)	.308 (7.82)	.165 (4.19)	.355 (9.02)	.555 (14.10)
MDM-25SBS*	1.740 (44.20)	1.500 (38.10)	.965 (24.51)	1.185 (30.10)	.802 (20.37)	.253 (6.43)	.308 (7.82)	.165 (4.19)	.355 (9.02)	.555 (14.10)
MDM-31PBS*	2.040 (51.82)	1.800 (45.72)	1.115 (28.32)	1.335 (33.91)	.884 (22.45)	.185 (4.70)	.308 (7.82)	.165 (4.19)	.355 (9.02)	.555 (14.10)
MDM-31SBS*	2.040 (51.82)	1.800 (45.72)	1.115 (28.32)	1.335 (33.91)	.952 (24.18)	.253 (6.43)	.308 (7.82)	.165 (4.19)	.355 (9.02)	.555 (14.10)
MDM-37PBS*	2.340 (59.44)	2.100 (53.34)	1.265 (32.13)	1.485 (37.72)	1.034 (26.26)	.185 (4.70)	.308 (7.82)	.165 (4.19)	.355 (9.02)	.555 (14.10)
MDM-37SBS*	2.340 (59.44)	2.100 (53.34)	1.265 (32.13)	1.485 (37.72)	1.102 (27.99)	.253 (6.43)	.308 (7.82)	.165 (4.19)	.355 (9.02)	.555 (14.10)
MDM-51PBS*	2.270 (67.66)	2.000 (50.80)	1.215 (30.86)	1.435 (36.45)	.984 (24.99)	.228 (5.79)	.351 (8.92)	.165 (4.19)	.355 (9.02)	.555 (14.10)
MDM-51SBS*	2.270 (67.66)	2.000 (50.80)	1.215 (30.86)	1.435 (36.45)	1.052 (26.72)	.296 (7.52)	.351 (8.92)	.165 (4.19)	.355 (9.02)	.555 (14.10)
MDM-100PBS*	3.070 (77.98)	2.800 (71.12)	1.800 (45.72)	2.175 (55.24)	1.384 (35.15)	.271 (6.88)	.460 (11.68)	.303 (7.70)	.550 (12.70)	.686 (17.42)
MDM-100SBS*	3.070 (77.98)	2.800 (71.12)	1.800 (45.72)	2.175 (55.24)	1.508 (38.30)	.394 (10.01)	.460 (11.68)	.303 (7.70)	.550 (12.70)	.686 (17.75)

\*For jackpost, add letter "P" or "M7" for sizes 9-51, "M17" for size 100.

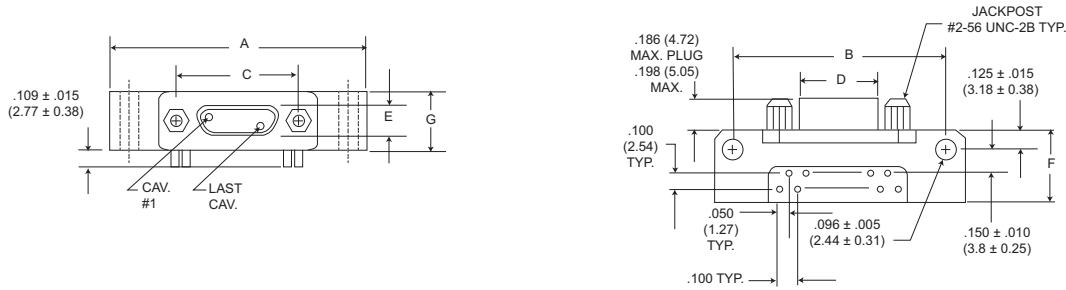
Dimensions shown in inch (mm)

Specifications and dimensions subject to change

www.ittcannon.com

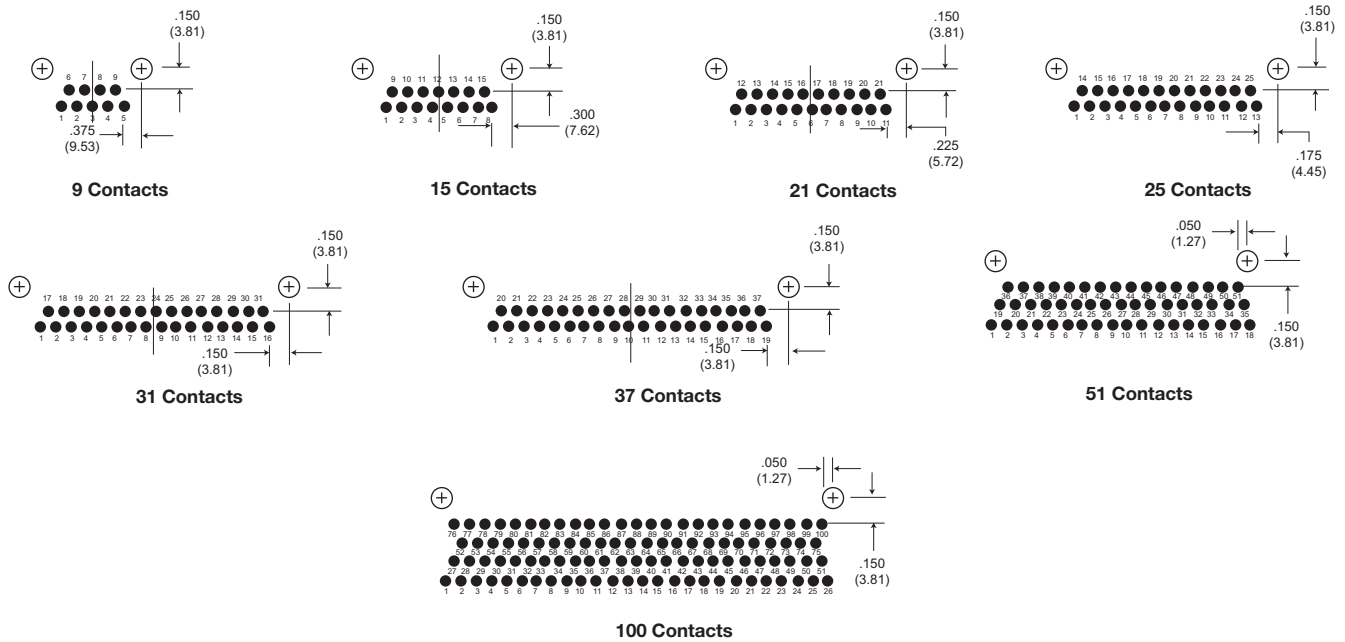


BR (Board Right Angle) Series



### PCB Termination Arrangements (Viewed from bottom of connector, PCB solder side.)

Identification number shown for plug connector, use reverse order for socket connector.



NOTE: Standard lead termination is #24 AWG, gold plated, solid copper, solder or tin dripped.

All Termination Configurations .100 (2.54) x .100 (2.54) Grid Pattern, Offset .050 (1.27).

Part Number By Shell Size	A Max.	B ± .007 (.18)	C ± .005 (.13)	D Max.	E Max.	F Max.	G Max.
MDM-9PBR*	1.390 (35.31)	1.150 (29.21)	.565 (14.35)	.334 (8.48)	.185 (4.70)	.455 (11.56)	.308 (7.82)
MDM-9SBR*	1.390 (35.31)	1.150 (29.21)	.565 (14.35)	.402 (10.21)	.253 (6.43)	.455 (11.56)	.308 (7.82)
MDM-15PBR*	1.540 (39.12)	1.300 (33.02)	.715 (18.16)	.484 (12.29)	.185 (4.70)	.455 (11.56)	.308 (7.82)
MDM-15SBR*	1.540 (39.12)	1.300 (33.02)	.715 (18.16)	.552 (13.97)	.253 (6.43)	.455 (11.56)	.308 (7.82)
MDM-21PBR*	1.690 (42.93)	1.450 (36.83)	.865 (21.97)	.634 (16.10)	.185 (4.70)	.455 (11.56)	.308 (7.82)
MDM-21SBR*	1.690 (42.93)	1.450 (36.83)	.865 (21.97)	.702 (17.83)	.253 (6.43)	.455 (11.56)	.308 (7.82)
MDM-25PBR*	1.790 (45.47)	1.550 (39.37)	.965 (24.51)	.734 (18.64)	.185 (4.70)	.455 (11.56)	.308 (7.82)
MDM-25SBR*	1.790 (45.47)	1.550 (39.37)	.965 (24.51)	.802 (20.37)	.253 (6.43)	.455 (11.56)	.308 (7.82)
MDM-31PBR*	2.040 (51.82)	1.800 (45.72)	1.115 (28.32)	.884 (22.45)	.185 (4.70)	.455 (11.56)	.308 (7.82)
MDM-31SBR*	2.040 (51.82)	1.800 (45.72)	1.115 (28.32)	.952 (24.18)	.253 (6.43)	.455 (11.56)	.308 (7.82)
MDM-37PBR*	2.340 (59.44)	2.100 (53.34)	1.265 (32.13)	1.034 (26.26)	.185 (4.70)	.455 (11.56)	.308 (7.82)
MDM-37SBR*	2.340 (59.44)	2.100 (53.34)	1.265 (32.13)	1.102 (27.99)	.253 (6.43)	.455 (11.56)	.308 (7.82)
MDM-51PBR*	1.875 (47.63)	1.600 (40.64)	1.215 (30.86)	.984 (24.99)	.228 (5.79)	.565 (14.35)	.351 (8.92)
MDM-51SBR*	1.875 (47.63)	1.600 (40.64)	1.215 (30.86)	1.052 (26.72)	.296 (7.52)	.565 (14.35)	.351 (8.92)
MDM-100PBR*	2.74 (69.72)	2.500 (63.50)	1.800 (45.72)	1.384 (35.15)	.271 (6.88)	.755 (19.18)	.394 (10.01)
MDM-100SBR*	2.74 (69.72)	2.500 (63.50)	1.800 (45.72)	1.508 (38.10)	.394 (10.01)	.755 (19.18)	.394 (10.01)

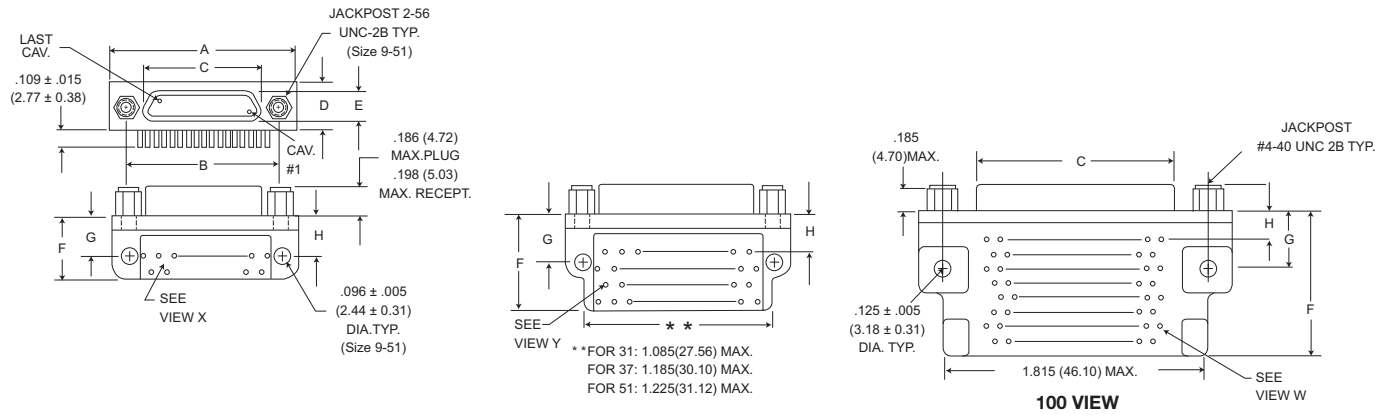
\*For jackpost, add letter "P" or "M7" for sizes 9-51, "M17" for size 100.



Dimensions shown in inch (mm)  
Specifications and dimensions subject to change

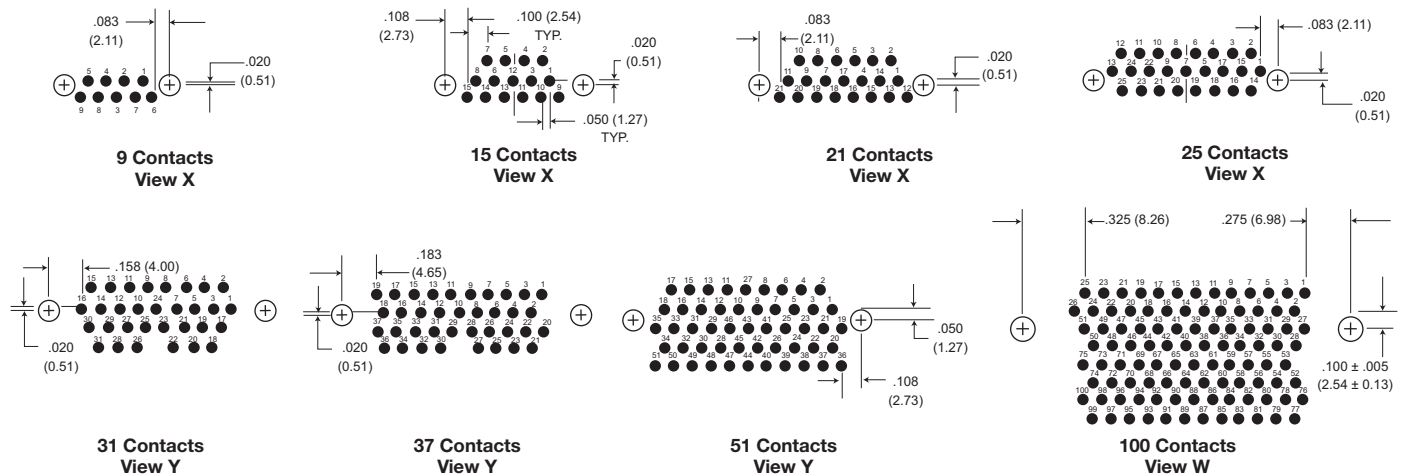
www.ittcannon.com

## CBR (Condensed Board Right Angle) Series



### PCB Termination Arrangements (Viewed from bottom of connector, PCB solder side.)

Identification number shown for plug connector, use reverse order for socket connector.



All Termination Configurations .100 (2.54) x .100 (2.54) Grid Pattern, Offset .050 (1.27).

NOTE: Standard lead termination is #24 AWG, solid copper, solder or tin dripped.

Part Number By Shell Size	A Max.	B ± .005 (.13)	C Max.	D Max.	E Max.	F Max.	G ± .010 (.25)	H ± .010 (.25)
MDM-9PCBR*	.785 (19.94)	.565 (14.35)	.334 (8.48)	.308 (7.82)	.185 (4.70)	.420 (10.67)	.250 (6.35)	.230 (5.81)
MDM-9SCBR*	.785 (19.94)	.565 (14.35)	.402 (10.21)	.308 (7.82)	.253 (6.43)	.420 (10.67)	.250 (6.35)	.230 (5.81)
MDM-15PCBR*	.935 (23.75)	.715 (18.16)	.484 (12.29)	.308 (7.82)	.185 (4.70)	.420 (10.67)	.250 (6.35)	.130 (3.30)
MDM-15SCBR*	.935 (23.75)	.715 (18.16)	.552 (13.97)	.308 (7.82)	.253 (6.43)	.420 (10.67)	.250 (6.35)	.130 (3.30)
MDM-21PCBR*	1.085 (27.56)	.865 (21.97)	.634 (16.10)	.308 (7.82)	.185 (4.70)	.420 (10.67)	.250 (6.35)	.130 (3.30)
MDM-21SCBR*	1.085 (27.56)	.865 (21.97)	.702 (17.83)	.308 (7.82)	.253 (6.43)	.420 (10.67)	.250 (6.35)	.130 (3.30)
MDM-25PCBR*	1.185 (30.10)	.965 (24.51)	.734 (18.64)	.308 (7.82)	.184 (4.70)	.420 (10.67)	.250 (6.35)	.130 (3.30)
MDM-25SCBR*	1.185 (30.10)	.965 (24.51)	.802 (20.37)	.308 (7.82)	.253 (6.43)	.420 (10.67)	.250 (6.35)	.130 (3.30)
MDM-31PCBR*	1.335 (33.91)	1.115 (28.32)	.884 (22.45)	.308 (7.82)	.185 (4.70)	.520 (13.21)	.250 (6.35)	.130 (3.30)
MDM-31SCBR*	1.335 (33.91)	1.115 (28.32)	.952 (24.18)	.308 (7.82)	.253 (6.43)	.520 (13.21)	.250 (6.35)	.130 (3.30)
MDM-37PCBR*	1.485 (37.72)	1.265 (32.13)	1.034 (26.26)	.308 (7.82)	.185 (4.70)	.520 (13.21)	.250 (6.35)	.130 (3.30)
MDM-37SCBR*	1.485 (37.72)	1.265 (32.13)	1.102 (27.99)	.308 (7.82)	.253 (6.43)	.520 (13.21)	.250 (6.35)	.130 (3.30)
MDM-51PCBR*	1.435 (36.45)	1.215 (30.86)	.984 (24.99)	.351 (8.92)	.228 (5.79)	.650 (16.15)	.300 (7.62)	.150 (3.81)
MDM-51SCBR*	1.435 (36.45)	1.215 (30.86)	1.052 (26.72)	.351 (8.92)	.296 (7.52)	.650 (16.15)	.300 (7.62)	.150 (3.81)
MDM-100PCBR*	2.170 (55.12)	1.800 (45.72)	1.384 (35.15)	.394 (10.01)	.271 (6.88)	1.000 (25.40)	.400 (10.16)	.200 (5.08)
MDM-100SCBR*	2.170 (55.12)	1.800 (45.72)	1.508 (38.10)	.394 (10.01)	.394 (10.01)	1.000 (25.40)	.400 (10.16)	.200 (5.08)

\*For jackpost, add letter "P" or "M7" for sizes 9-51, "M17" for size 100.

Dimensions shown in inch (mm)

Specifications and dimensions subject to change

www.ittcannon.com



# Micro-D Coaxial/Power - .050" Contact Spacing

# MDM C/P



## MDM Coaxial

The MDM Metal Shell Connectors have been tooled in several coaxial layouts and offer the versatility of combining coaxial and signal lines in the same connector. Any modifications to these layouts or new requirements, please consult the factory. Standard coax is RG178 white.

## MDM Power

The same insulator that is used with coaxial contacts is available with power contacts. This offers the versatility of combining power and signal lines in the same connector.

## MDM Coaxial/Power

Power and coaxial contacts can be interchanged as desired. Power contacts are rated at 13 amps, 24V rms, AWG #16 stranded.

## How to Order

For MIL-DTL-83513 ordering information see pages 16 and 17

### SERIES

MDM: (Size 9-100) Liquid Crystal Polymer (LCP)  
MDM: (Combo Layout) Diallyl Phthalate (DAP)

### CONTACT ARRANGEMENTS

9-15-21-25-31-37-51-100 (standard)  
16C5, 10C10, 7C2, 24C4 (coaxial)  
16P5, 10P10, 7P2, 24P4 (power) } or combination of  
coax and power

### CONTACT TYPE

P - Pin S - Socket

### TERMINATION TYPE

H - Harness-insulated wire.  
L - Solid-uninsulated wire.  
S - Solder pot to accept #26 AWG MAX. harness wire. (Not available with power contact arrangements.)

### HARDWARE

M - Military specification hardware, see page 11 for military hardware codes.  
P - Jackpost  
K - Jackscrew-standard profile  
L - Jackscrew-low profile



RoHS COMPLIANCE

SERIES

CONTACT ARRANGEMENTS

CONTACT TYPE

TERMINATION TYPE

TERMINATION CODE

HARDWARE

SHELL FINISH MOD CODES

F - Float mount

B - No hardware standard

.091 (2.31) dia. hole for sizes 9-51;  
.120 (3.05) dia. hole for size 100.

A - .125 (3.18) dia. mounting holes for sizes 9-51;  
.166 (4.22) dia. hole for size 100.

B1 - .1475 (3.75) dia. hole for size 100  
(Per MIL-DTL-83513)

### TERMINATION CODE\*

(H) 001 - 18", 7/34 strand, #26 AWG,  
MIL-W-16878/4, Type E Teflon, yellow.

(H) 003 - 18", 7/34 strand, #26 AWG,  
MIL-W-16878/4, Type E Teflon,  
color coded to MIL-STD-681 System I.

(L) 1 - 1/2" uninsulated solid #25  
AWG gold plated copper.

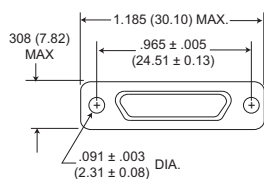
(L) 2 - 1" uninsulated solid #25 AWG  
gold plated copper.

### SHELL FINISH MOD CODES

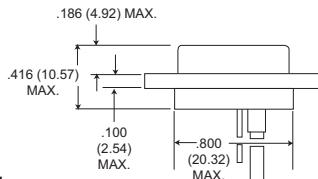
No Number - (Standard cadmium/yellow  
chromate over nickel  
A174 - Electroless nickel  
A172 - Gold over nickel  
A141 - Iridite/alodine  
A30 - Black anodize

\*See page 79 and 81 for additional Termination codes.

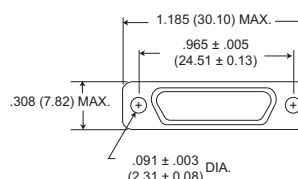
## 7C2/7P2



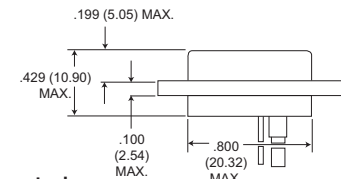
Plug



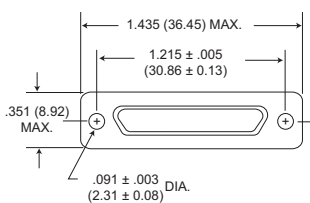
Receptacle



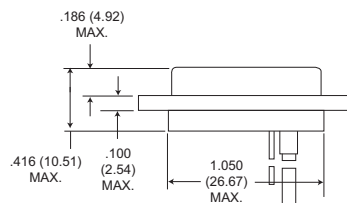
Receptacle



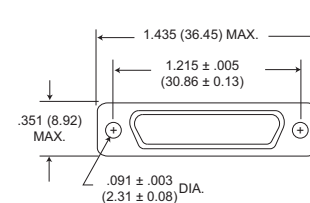
## 24C4/24P4



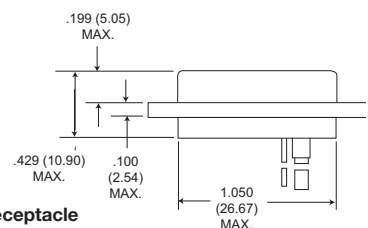
Plug



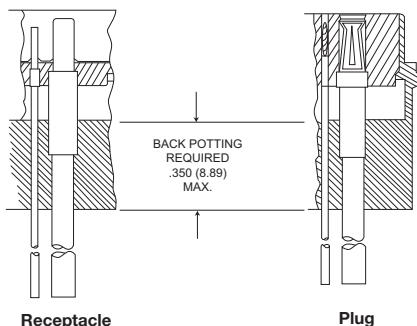
Receptacle



Receptacle



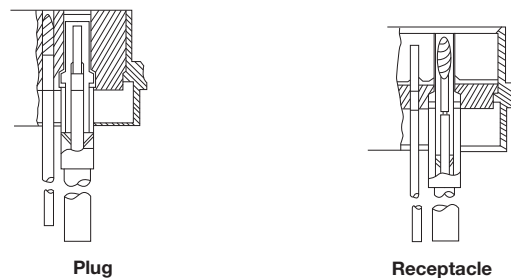
## Power Contacts



Receptacle

Plug

## Coaxial Contacts



Plug

Receptacle



Dimensions shown in inch (mm)  
Specifications and dimensions subject to change

www.ittcannon.com



MDMH connectors are ideal for applications requiring a better seal than can be achieved with epoxy resins.

The connector utilizes size 24 AWG contacts that are compression glass sealed through a steel shell and into a diallyl pthalate front end insulator. An interfacial seal provides environmental protection when mated. We recommend MDMH receptacles be soldered to the chassis or container for a completely leak-proof joint.

MDMH receptacles mate with standard MDM plugs.

### Features

- Hermetically sealed connector designed for those applications where a vacuum, inert gas or a constant controlled pressure are required to eliminate adverse effects created by atmospheric changes.
- Steel shells to provide greater strength, prevent chipping, cracking or breaking, offer electro-magnetic (EMI) and RFI shielding.
- Silicone elastomer compression interfacial seal to provide a moisture and humidity seal between each contact and between contacts and shell.

## Specifications

### Standard materials & finishes

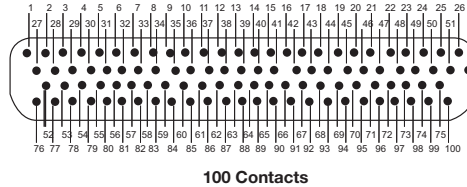
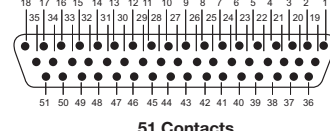
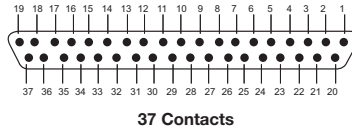
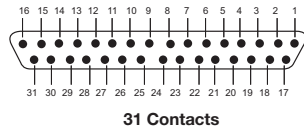
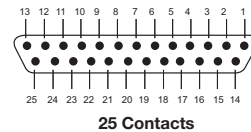
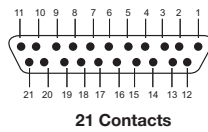
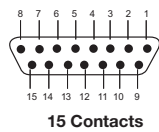
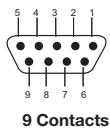
Shell	Mild steel, tin-lead plated
Insulator	Glass filled diallyl pthalate per MIL-M-14. Type SDGF
Contacts	Copper alloy, gold plated sockets on mild steel gold plated pins. Solder pots - mild steel gold plated
Hermetic seal	Compression glass
Leak rate	1 micron cubic ft/hr max (1.04 x 10 <sup>-5</sup> cc/sec at 1 ATM pressure differential)
<b>ELECTRICAL DATA</b>	
No. of contacts	9 to 100
Dielectric withstanding voltage	150 VAC
Insulation resistance	5000 Mohm minimum
Wire size	#26 through #30 AWG
Contact termination	Solder pot
<b>MECHANICAL FEATURES</b>	
Size or length	8 sizes
Service class	Hermetically sealed
Coupling	Friction/jacks
Polarization	Keystone shaped shells
Contact spacing	.050 (1,27) centers
Shell style	Receptacle, solder mount

## How to Order



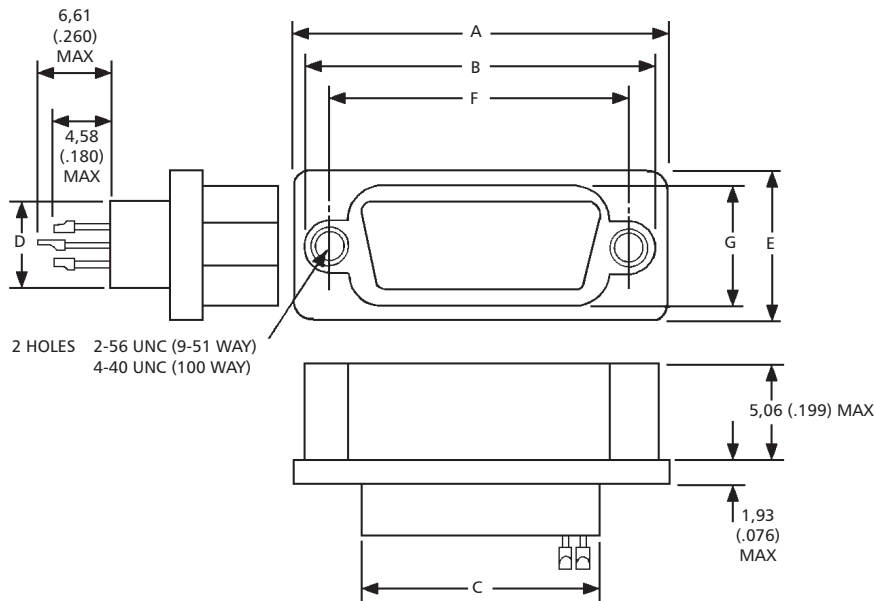
## Contact Arrangements

Face view of socket insert - use reverse order for wiring side.



Contact identification numbers are for reference only and do not appear on insulator or connector body.

## Shell Dimensions



Part Number by shell size	A max	B max	C max	D max	E max	F ±.005 (0,13)	G max
MDMH-9S	.885 (22,48)	.738 (18,74)	.400 (10,16)	.270 (6,86)	.430 (10,92)	.565 (14,35)	.261 (6,63)
MDMH-15S	1.035 (26,29)	.888 (22,55)	.550 (13,97)	.270 (6,86)	.430 (10,92)	.715 (18,16)	.261 (6,63)
MDMH-21S	1.185 (30,10)	1.038 (26,36)	.770 (17,78)	.270 (6,86)	.430 (10,92)	.865 (21,97)	.261 (6,63)
MDMH-25S	1.285 (32,64)	1.137 (28,87)	.800 (20,32)	.270 (6,86)	.430 (10,92)	.965 (24,51)	.261 (6,63)
MDMH-31S	1.435 (36,45)	1.288 (32,72)	.950 (24,13)	.270 (6,86)	.430 (10,92)	1.115 (28,32)	.261 (6,63)
MDMH-37S	1.585 (40,26)	1.438 (36,53)	1.100 (27,94)	.270 (6,86)	.430 (10,92)	1.265 (32,13)	.261 (6,63)
MDMH-51S	1.535 (38,99)	1.388 (35,26)	1.050 (26,67)	.310 (8,00)	.473 (12,01)	1.215 (30,86)	.315 (8,00)
MDMH-100S	2.275 (57,78)	2.078 (52,78)	1.455 (36,97)	.365 (9,27)	.522 (13,26)	1.800 (45,72)	.410 (10,41)



Dimensions shown in inch (mm)  
Specifications and dimensions subject to change

www.ittcannon.com



With an increasing number of MDM connectors being used in avionics and military equipment and with increasing emphasis being put on EMI, RFI and EMP shielding, Cannon have developed a range of filter connectors to suit most applications.

The TMDM receptacle accommodates from 8 to 37 sizes, 24 AWG socket contacts on 1,27 (.050) centres and mates with the standard MDM plugs.

### Features

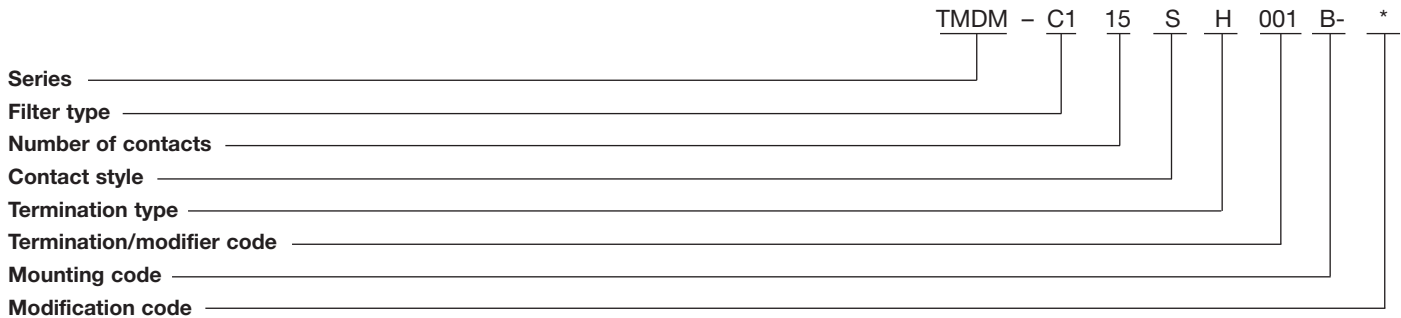
- Transverse monolith filter for EMI and RFI shielding.
- Rugged aluminum one piece shell.
- Silicone interfacial environmental seal.
- Glass filled diallyl phthalate insulator.
- A variety of filter types for each pin.

## Specifications

### Standard materials & finishes

Shell	Aluminum alloy per QQ-A-200/8 with electroless nickel finish per QQ-N-290
Insulator	Glass filled diallyl phthalate per MIL-M-14. Type SDGF
Contact, socket	Copper alloy, 50 microinch gold per MIL-G-45204, Type II, Class I
Interfacial seal	Silicone base rubber
<b>ELECTRICAL DATA</b>	
No. of contacts	9 to 37
Dielectric withstanding voltage	300 VAC
Insulation resistance	5000 Mohm at 100 VDC
Voltage rating (working)	100 VDC
Current rating	3 amps max.
Maximum capacitance	250, 500, 1000, 2000 picofarads
Filter type	C
<b>MECHANICAL FEATURES</b>	
Size or length	6 sizes
Coupling	Friction/jackscrews
Polarization	Keystone shaped shell
Contact spacing	.050 (1,27) centers
Shell style	Single piece receptacle

## How to Order



### Series:

Filter TMDM - Micro "D" - Metal housing

### Filter type:

- "C" capacitor type
- C1 150 - 250 pF capacitance
- C2 300 - 500 pF capacitance
- C3 700 - 1000 pF capacitance
- C4 1300 - 2000 pF capacitance

### Number of contacts:

9, 15, 21, 25, 31, 37 only

### Contact style:

- S - socket (receptacle)
- P - Pin (plug)

### Termination type:

- H - harness, insulated solid or stranded wire
- L - lead, solid uninsulated wire

### Termination:

Consult standard wire termination code for lead material and lead length

### Mounting code:

- A - Flange mounting, Ø.125 (3,18) mounting holes
- B - Flange mounting, Ø.092 (2,34) mounting holes
- L - Low profile (slotted head)
- M2 - Allen head jackscrew assembly,

low profile

- M3 - Allen head jackscrew assembly, high profile
- M5 - Slot head jackscrew assembly, low profile
- M6 - Slot head jackscrew assembly, high profile
- M7 - Jacknut assembly
- P - Jackpost

### Modification code:

Shell finish MOD. Codes. \*  
To be assigned as required

\* No number = Standard tin/lead finish

Dimensions shown in inch (mm)

Specifications and dimensions subject to change

www.ittcannon.com



## Guaranteed Minimum Attenuation

Filter designation	Capacitance range (pF)	Minimum Insertion Loss-decibels							
		10 MHz	15 MHz	30 MHz	50 MHz	100 MHz	200 MHz	500 MHz	1 GHz
C1	150 - 250				4	6	15	20	35
C2	300 - 500			3	6	12	18	25	40
C3	700 - 1000		3	7	13	17	25	38	48
C4	1300 - 2000	5	8	13	18	23	30	40	50

## Standard Wire Termination Codes

Cannon Modification Codes – (Not Mil Spec)

The following termination codes are listed for your information. For additional codes please refer to Appendix on page 79 and 81. **All wire lengths are minimum.**

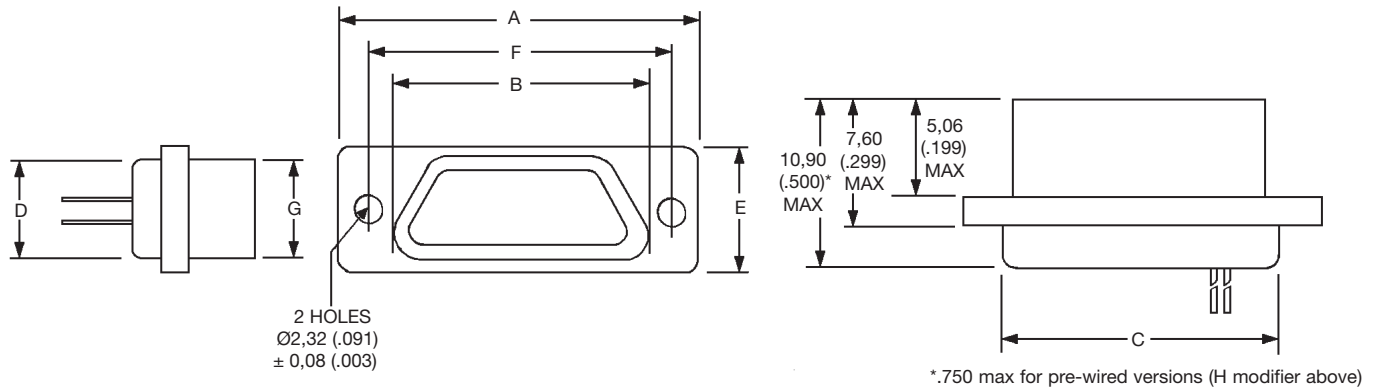
**Harness Type (H) #26 AWG per MIL-W-16878/4 Type E Teflon, stranded**

Length	All Yellow	Color Coded
3 (76.2)	H020	H027
6 (152.4)	H019	H016
8 (203.2)	H026	H034
10 (254.0)	H029	H025
12 (304.8)	H028	H002
18 (457.2)	H001	H003
20 (508.0)	H038	H023
24 (509.6)	H009	H004
30 (762.0)	H010	H005
36 (914.4)	H011	H006
48 (1219.2)	H013	H048
72 (1828.8)	H017	H046
120 (3048.0)	H042	H041

**Solid Uninsulated Type (L) #25 AWG gold plated copper.**

Code	Length
L61	.125 (.18)
L56	.150 (3.81)
L57	.190 (4.83)
L39	.250 (5.35)
L58	.375 (9.52)
L1	.500 (12.70)
L14	.750 (19.05)
L2	1.000 (25.40)
L7	1.500 (38.10)
L6	2.000 (50.80)
L6	2.500 (63.50)
L10	3.000 (76.20)

## Shell Dimensions



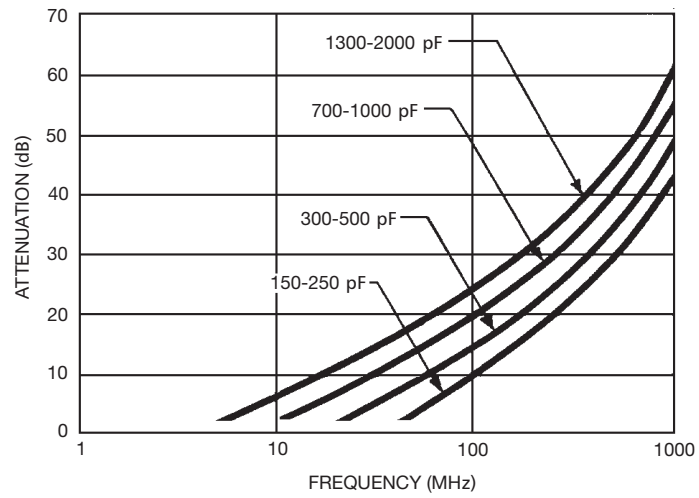
Part Number by shell size	A max	B max	C max	D max	E max	F max ±0,13 (.005)	G max
MDMT-9S*	.785 (19,94)	.400 (10,16)	.400 (10,16)	.270 (6,86)	.308 (7,83)	.565 (14,36)	.251 (6,38)
MDMT-15S*	.935 (23,75)	.550 (13,97)	.550 (13,97)	.270 (6,86)	.308 (7,83)	.715 (18,17)	.251 (6,38)
MDMT-21S*	1.085 (27,60)	.700 (17,78)	.700 (17,78)	.270 (6,86)	.308 (7,83)	.865 (21,98)	.251 (6,38)
MDMT-25S*	1.185 (30,10)	.800 (20,32)	.800 (20,32)	.270 (6,86)	.308 (7,83)	.965 (24,52)	.251 (6,38)
MDMT-31S*	1.335 (33,90)	.950 (24,13)	.950 (24,13)	.270 (6,86)	.308 (7,83)	1.115 (28,30)	.251 (6,38)
MDMT-37S*	1.485 (37,70)	1.100 (28,00)	1.100 (28,00)	.270 (6,86)	.308 (7,83)	1.265 (32,20)	.251 (6,38)



Dimensions shown in inch (mm)  
Specifications and dimensions subject to change

www.ittcannon.com

## Typical Filter Performance



Dimensions shown in inch (mm)  
Specifications and dimensions subject to change

[www.ittcannon.com](http://www.ittcannon.com)



# Micro-D Plastic Shell - .050" Contact Spacing

MD\*\*

## Microminiature Rectangular Connectors with MICRO-Pin Contacts on .050 (1.27) centers.

MICRO-D microminiature rack/panel connectors are used in applications requiring highly reliable, extremely small, lightweight connectors. These connectors are available in 2 insulator materials, 2 mounting variations, 7 shell sizes accommodating from 9 to 51 contacts and a special arrangement of 5 micro contacts and 2 coaxials. The insulator materials listed give the MICRO-D connector wide versatility in most applications required by industry.

ITT can also terminate a wide variety of stranded or solid wire directly to MICRO-D contacts, which is often desirable in high density arrangements.

MICRO-D connectors can also be custom harnessed to meet any customer requirement of single or multiple connectors. Pigtail lead and harness description must be given by the customer. A typical description would be: .5" #25 AWG, gold plated copper leads or 18" of #26 yellow, Teflon-insulated, Type E wire. Shown below are various methods of termination. Consult customer service for any routine or complex harnessing of MICRO-D connectors.

- Glass-filled diallyl phthalate thermoset material used in high temperature applications that is immune to cleaning solvents. It also has excellent dielectric properties. Temperature range: -65°F to +300°F (-55°C to +149°C).
- Glass-filled polyester thermoplastic that is not affected by cleaning solvents and exhibits excellent dielectric properties. Temperature range: -55°F to +257°F (-65°C to +125°C).

## Specifications

### MATERIALS AND FINISHES

Shell/Insulator (One Piece)	MD/MDB: Glass-filled thermoset plastic MDV/MDVB: Thermoplastic
Contacts	- Copper alloy, gold plate

### ELECTRICAL DATA

No of Contacts	- 9 to 51: (1 arrangement of 5 contacts and 2 coaxials - for screw mount only)
Coaxial Cable	- RG-178/U (Not available for MD clip mount)
Wire Size	- #24 thru #32 AWG
Contact Termination	- Multi-indent crimp

### MECHANICAL FEATURES

Size or Length	- 7 sizes
Coupling	- Friction/jackscrews
Polarization	- Keystone-shaped shells
Contact Spacing Centers	-.050 (1.27mm)
Shell Styles	- Plug and receptacle

Consult factory for availability.

## How to Order

PCB ordering information - page 30



RoHS COMPLIANCE

SERIES-INSULATOR STYLE-MATERIAL

CONTACT SPACING

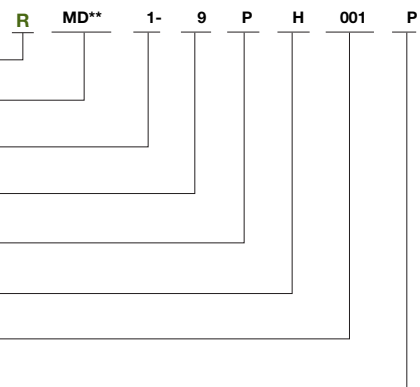
CONTACT ARRANGEMENT

CONTACT TYPE

TERMINATION TYPE

TERMINATION CODE

LOCKING HARDWARE



### SERIES-INSULATOR STYLE-MATERIAL

MDB - Screw mounting-Diallyl phthalate  
MDVB - Screw mounting-Polyester

### CONTACT SPACING

1 - .050 (1.27) centers

### CONTACT ARRANGEMENT

9-15-21-25-31-37-51. See page 9

### CONTACT TYPE

P - Pin S - Socket

### TERMINATION TYPE

H - Insulated solid or stranded wire  
L - Uninsulated solid wire  
S - Solder pot to accept #26 AWG max. harness wire.

### TERMINATION CODE

See page 79 and 81 for additional codes

(H) 001 - 18", 7/34 strand, #26 AWG, MIL-W-16878/4, Type E Teflon, Yellow.  
(H) 003 - 18", 7/34 strand, #26 AWG, MIL-W-16878/4, Type E Teflon, color coded to MIL-STD-681 System I.

(L) 1 - 1/2" uninsulated solid #25 AWG gold plated copper.  
(L) 2 - 1" uninsulated solid #25 AWG gold plated copper.

### LOCKING HARDWARE (SCREW MOUNTING ONLY)

P - Jackpost  
K - Jackscrew-standard  
L - Jackscrew-low profile  
F - Float mount  
M - Military specification hardware, see page 13.

No designator - No hardware - standard mounting  
.091 (2.31) hole diameter



Dimensions shown in inch (mm)  
Specifications and dimensions subject to change

www.ittcannon.com

## Standard Wire Termination Codes

The following termination codes are listed for your information. For additional codes please refer to Appendix on page 79 and 81. **All wire lengths are minimum.**

### Harness Type (H)

#26 AWG per MIL-W-16878 Type E Teflon, stranded.

Length	All Yellow	Color Coded*
3 (76.2)	H020	H027
6 (152.4)	H019	H016
8 (203.2)	H026	H034
10 (254.0)	H029	H025
12 (304.8)	H028	H002
18 (457.2)	H001	H003
20 (508.0)	H038	H023
24 (609.6)	H009	H004
30 (762.0)	H010	H005
36 (914.4)	H011	H006
48 (1219.2)	H013	H048
72 (1828.8)	H017	H046
120 (3048.0)	H042	H041

\*Cavity #1 black

### Solid Uninsulated Type (L)

#25 AWG Gold Plated Copper

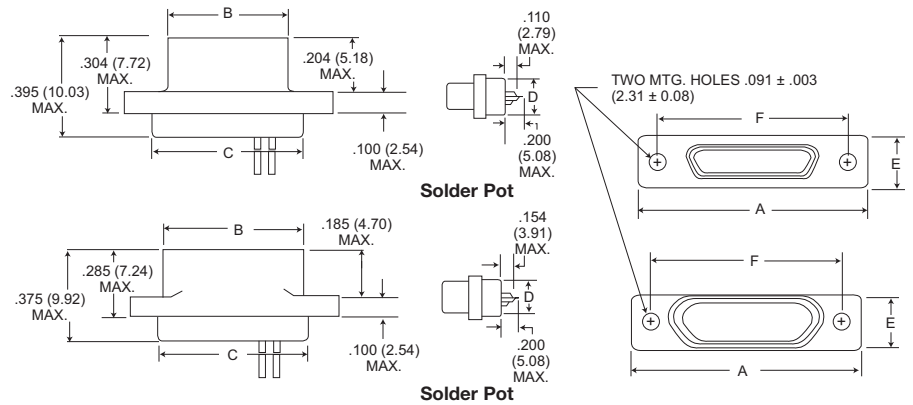
Termination Code	Length
L61	.125 (3.18)
L56	.150 (3.81)
L57	.190 (4.83)
L39	.250 (6.35)
L58	.375 (9.52)
L1	.500 (12.70)
L14	.750 (19.05)
L2	1.000 (25.40)
L7	1.500 (38.10)
L6	2.000 (50.80)
L16	2.500 (63.50)
L10	3.000 (76.20)

## With Screw Mounting Holes (Conforms to MIL-DTL-83513)



**MDB** Glass-filled Diallyl Phthalate Plastic Insulator

**MDVB** Glass-filled Polyester Plastic Insulator



Part Number by Shell Size		A Max.	B Max.	C Max.	D Max.	E Max.	F ±.005	Avg. Weight*** ±5% (oz.) ±5% (gm.)
<b>MDB1-9P**</b>	<b>MDVB1-9P**</b>	.788 (20.02)	.292 (7.42)	.408 (10.36)	.173 (4.39)	.218 (5.54)	.565 (14.35)	.026 (0.73)
<b>MDB1-9S**</b>	<b>MDVB1-9S**</b>	.788 (20.02)	.380 (9.65)	.408 (10.36)	.173 (4.39)	.218 (5.54)	.565 (14.35)	.025 (0.70)
<b>MDB1-15P**</b>	<b>MDVB1-15P**</b>	.938 (23.82)	.442 (11.23)	.588 (14.17)	.173 (4.39)	.218 (5.54)	.715 (18.16)	.038 (1.10)
<b>MDB1-15S**</b>	<b>MDVB1-15S**</b>	.938 (23.82)	.530 (13.46)	.588 (14.17)	.173 (4.39)	.218 (5.54)	.715 (18.16)	.035 (1.00)
<b>MDB1-21P**</b>	<b>MDVB1-21P**</b>	1.088 (27.64)	.592 (15.04)	.708 (17.98)	.173 (4.39)	.218 (5.54)	.865 (21.97)	.053 (1.50)
<b>MDB1-21S**</b>	<b>MDVB1-21S**</b>	1.088 (27.64)	.680 (17.27)	.708 (17.98)	.173 (4.39)	.218 (5.54)	.865 (21.97)	.050 (1.40)
<b>MDB1-25P**</b>	<b>MDVB1-25P**</b>	1.188 (30.18)	.692 (17.58)	.808 (20.56)	.173 (4.39)	.218 (5.54)	.965 (24.51)	.063 (1.80)
<b>MDB1-25S**</b>	<b>MDVB1-25S**</b>	1.188 (30.18)	.780 (19.81)	.808 (20.56)	.173 (4.39)	.218 (5.54)	.965 (24.51)	.056 (1.60)
<b>MDB1-31P**</b>	<b>MDVB1-31P**</b>	1.338 (33.98)	.842 (21.39)	.958 (24.33)	.173 (4.39)	.218 (5.54)	1.115 (28.32)	.080 (2.30)
<b>MDB1-31S**</b>	<b>MDVB1-31S**</b>	1.338 (33.98)	.930 (23.62)	.958 (24.33)	.173 (4.39)	.218 (5.54)	1.115 (28.32)	.073 (2.10)
<b>MDB1-37P**</b>	<b>MDVB1-37P**</b>	1.488 (37.80)	.992 (25.20)	1.108 (28.14)	.173 (4.39)	.218 (5.54)	1.265 (32.13)	.086 (2.45)
<b>MDB1-37S**</b>	<b>MDVB1-37S**</b>	1.488 (37.80)	1.080 (27.43)	1.108 (28.14)	.173 (4.39)	.218 (5.54)	1.265 (32.13)	.076 (2.15)
<b>MDB1-51P**</b>	<b>MDVB1-51P**</b>	1.438 (36.52)	.942 (23.93)	1.058 (26.87)	.220 (5.59)	.260 (6.60)	1.215 (30.86)	.109 (3.10)
<b>MDB1-51S**</b>	<b>MDVB1-51S**</b>	1.438 (36.52)	1.030 (26.16)	1.058 (26.87)	.220 (5.59)	.260 (6.60)	1.215 (30.86)	.093 (2.64)

\*\* Add lead type and length, see Part Number Explanation.

\*\*\* Weight given is with 1/2", uninsulated solid #25 AWG gold plated copper pigtailed.

Dimensions shown in inch (mm)

Specifications and dimensions subject to change

www.ittcannon.com



MD\*B-PCB connectors use standard MD\*B all plastic shells and are designed for use with flex circuitry, printed circuit and multi-layer boards. They are easily mounted and soldered and provide high density/high reliability in board-to-board and board-to-cable applications. While being similar to the MDM-PCB connectors, the MD\*B-PCB connectors are all plastic, extremely small, and lightweight yet rugged enough for use in the most demanding applications.

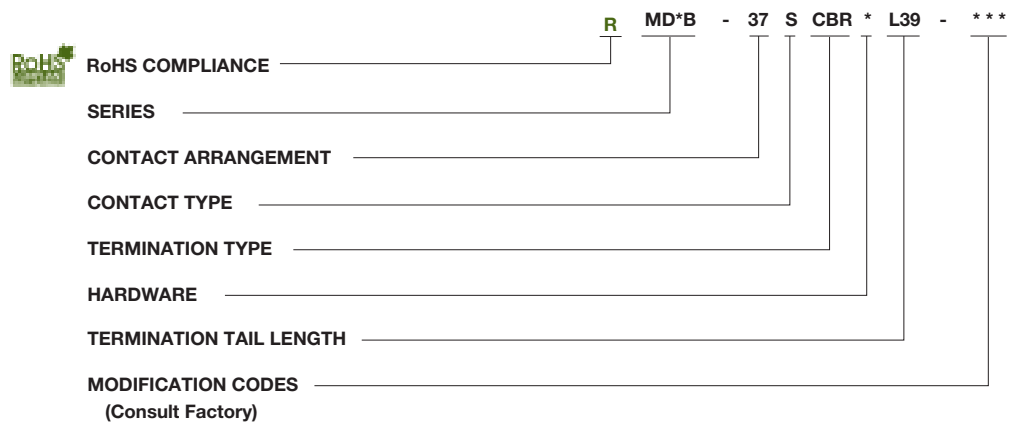
Jackpost mounting for use with locking hardware is also available.

If the connectors shown in the catalog do not meet the requirements of your applications, a special shape, size or layout using the basic all plastic shell can be made available. For further technical and applications information, contact customer service.



MD\*B-PCB connectors are available in seven shell sizes with 9 to 51 contacts in the popular 90° narrow profile PCB termination, with a variety of tail lengths for varying board thickness.

## How to Order



**CONNECTOR SERIES**  
MDVB, MDB

**CONNECTOR ARRANGEMENT**  
9, 15, 21, 25, 31, 51

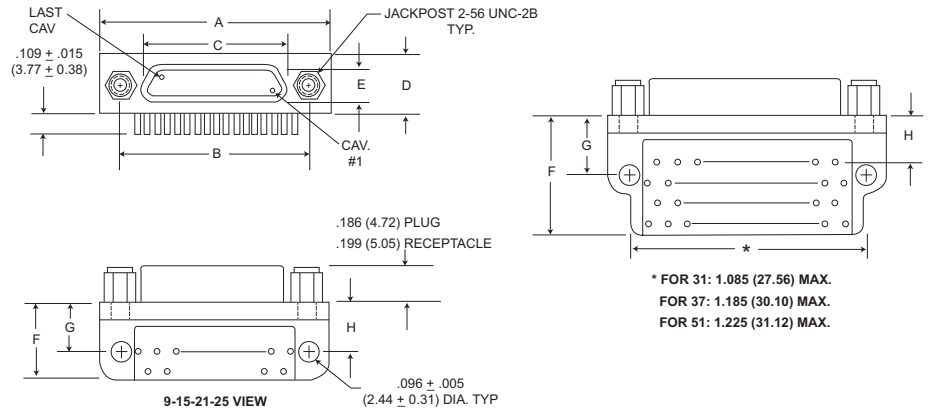
**CONTACT TYPE**  
S = Socket  
P = Pin

**TERMINATION TYPE**  
CBR = 90° Narrow Profile PCB Terminations

**HARDWARE**  
P = Jackpost  
M7 = Jackposts, M635135-07  
No Letter = Less Hardware

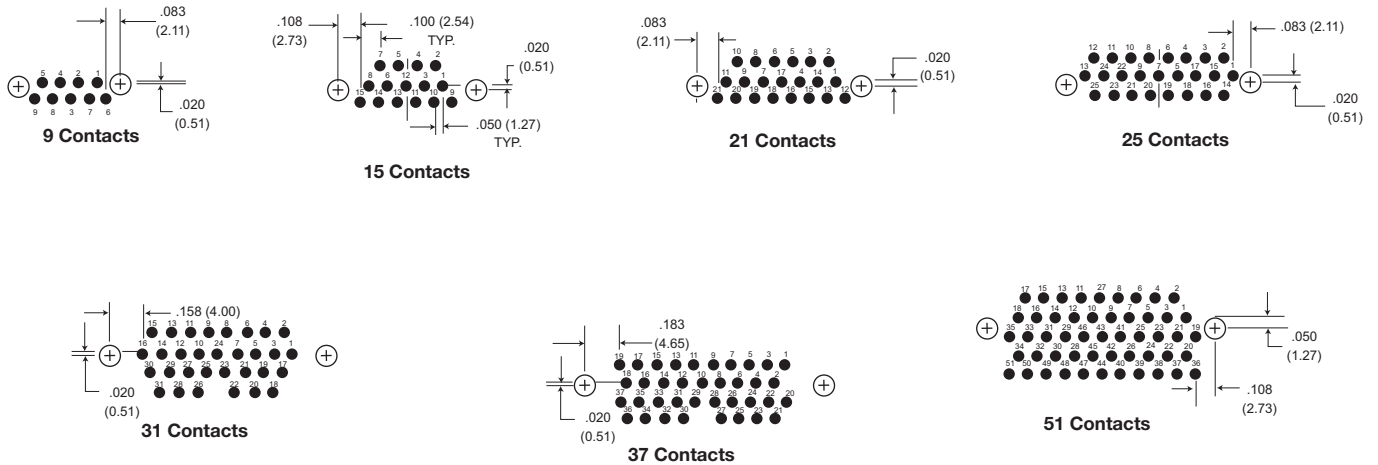
**TERMINATION TAIL LENGTH CODES**  
NONE - .109 (2.77) ± 0.15 (0.38) Standard  
L61 - .125 (3.18)  
L66 - .150 (3.81)  
L57 - .190 (4.83)  
L39 - .250 (6.35)  
L58 - .375 (9.52)

CBR Series (90° Mounting Narrow Profile)



### PCB Termination Arrangements (Viewed from bottom of connector, on PCB solder side.)

Identification number shown for plug connector, use reverse order for socket connector.



All Termination Configurations .100 (2.54) x .100 (2.54) Grid Pattern, Offset .050 (1.27)

Part Number By Shell Size	A Max.	B ± .005 (0.13)	C Max.	D Max.	E Max.	F Max.	G ± .010 (0.25)	H ± .010 (0.25)
MD*B-9PCBR*	.788 (20.01)	.565 (14.35)	.292 (7.42)	.218 (5.54)	.134 (3.40)	.420 (10.67)	.250 (6.35)	.230 (5.84)
MD*B-9SCBR*	.788 (20.01)	.565 (14.35)	.375 (9.52)	.218 (5.54)	.218 (5.54)	.420 (10.67)	.250 (6.35)	.230 (5.84)
MD*B-15PCBR*	.938 (23.82)	.715 (18.16)	.442 (11.23)	.218 (5.54)	.134 (3.40)	.420 (10.67)	.250 (6.35)	.130 (3.30)
MD*B-15SCBR*	.938 (23.82)	.715 (18.16)	.525 (13.34)	.218 (5.54)	.218 (5.54)	.420 (10.67)	.250 (6.35)	.130 (3.30)
MD*B-21PCBR*	1.088 (27.63)	.865 (21.97)	.592 (15.04)	.218 (5.54)	.134 (3.40)	.420 (10.67)	.250 (6.35)	.130 (3.30)
MD*B-21SCBR*	1.088 (27.63)	.865 (21.97)	.675 (17.14)	.218 (5.54)	.218 (5.54)	.420 (10.67)	.250 (6.35)	.130 (3.30)
MD*B-25PCBR*	1.188 (30.17)	.965 (24.51)	.692 (17.58)	.218 (5.54)	.134 (3.40)	.420 (10.67)	.250 (6.35)	.130 (3.30)
MD*B-25SCBR*	1.188 (30.17)	.965 (24.51)	.775 (19.68)	.218 (5.54)	.218 (5.54)	.420 (10.67)	.250 (6.35)	.130 (3.30)
MD*B-31PCBR*	1.338 (33.98)	1.115 (28.32)	.842 (21.39)	.218 (5.54)	.134 (3.40)	.420 (10.67)	.250 (6.35)	.130 (3.30)
MD*B-31SCBR*	1.338 (33.98)	1.115 (28.32)	.925 (23.50)	.218 (5.54)	.218 (5.54)	.420 (10.67)	.250 (6.35)	.130 (3.30)
MD*B-37PCBR*	1.488 (37.79)	1.265 (32.13)	.994 (25.25)	.218 (5.54)	.134 (3.40)	.520 (13.21)	.250 (6.35)	.130 (3.30)
MD*B-37SCBR	1.488 (37.79)	1.265 (32.13)	1.075 (27.30)	.218 (5.54)	.218 (5.54)	.520 (13.21)	.250 (6.35)	.130 (3.30)
MD*B-51PCBR*	1.438 (36.52)	1.215 (30.86)	.942 (23.93)	.258 (6.55)	.177 (4.50)	.550 (13.97)	.300 (7.62)	.150 (3.81)
MD*B-51SCBR	1.438 (36.52)	1.215 (30.86)	1.026 (26.06)	.258 (6.55)	.258 (6.55)	.550 (13.97)	.300 (7.62)	.150 (3.81)

\* For jackpost locking add letter "P" or "M7".

**NOTE: Standard lead termination is #24 AWG, solid copper, solder or tin dipped.**

Dimensions shown in inch (mm)  
 Specifications and dimensions subject to change

www.ittcannon.com

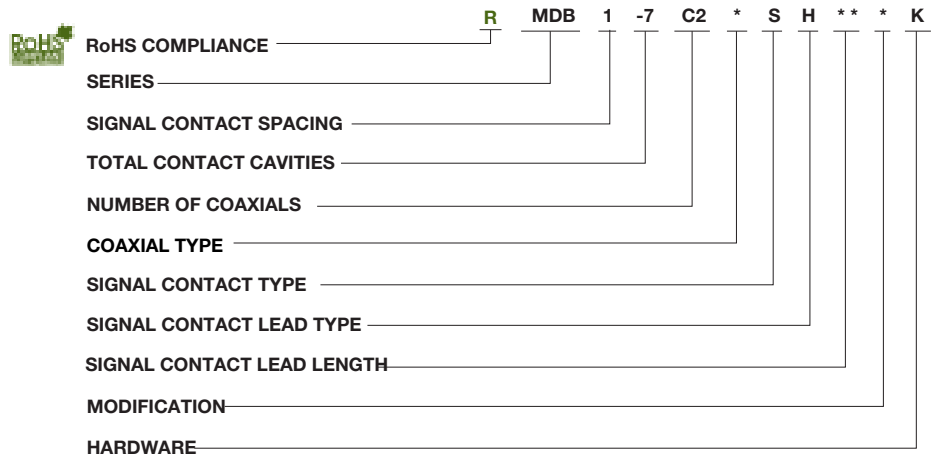


## MDB Coaxial Series with Screw Mounting Holes

MDB connectors with two coaxial and five MICRO-PIN™/MICROSOCKET™ contacts. Crimp-type coaxial contacts accommodate RG-178/U cables. A plastic insertion/extraction tool is supplied with each connector assembly having removable coaxial assembly.



## How to Order - MDB Coaxial



### SERIES

Micro-D Coaxial

### SIGNAL CONTACT SPACING

1 - .050 (1.27) centers

### TOTAL CONTACT CAVITIES

### NUMBER OF COAXIALS

### COAXIAL TYPE

No Letter - Coaxial assembly installed and nonremovable  
 RO - coaxial assembly ordered separately  
 RA - Coaxial shipped assembled but uninstalled

### SIGNAL CONTACT TYPE

P - Pin  
 S - Socket

### SIGNAL CONTACT LEAD TYPE

L - Uninsulated, solid wire  
 H - Insulated, solid or stranded  
 S - Solder pot\*

### SIGNAL CONTACT LEAD LENGTH

See Standard Wire Termination  
 Code on page 29. Coaxial cable will be RG-178U unless otherwise specified; length will be same as wire modification.

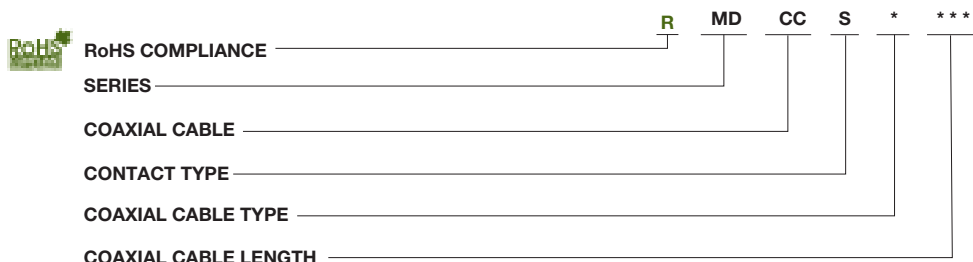
### MODIFICATION

Consult customer service

### HARDWARE

No letter - No hardware standard mounting. .091 (2.31) hole diameter  
 F - Float  
 K - Jackscrew (standard)  
 L - Jackscrew (low profile)  
 P - Jackpost  
 \* Not available with removalbe coax cable type connectors RO and RA.

## How to Order - Coaxial Cable Assemblies



### SERIES

MD

### COAXIAL CABLE

CC

### CONTACT TYPE

P - Pin (used with socket side connection)  
 S - Socket (used with pin type connection)

### COAXIAL CABLE TYPE

1 - RG178/U

### COAXIAL CABLE LENGTH

See Standard Wire Termination  
 Codes on page 29. Coaxial cable will be RG-178U unless otherwise specified; length will be the same as wire modification.



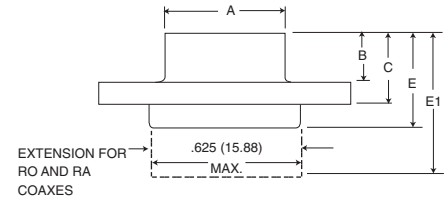
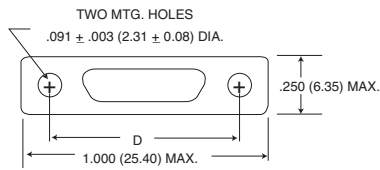
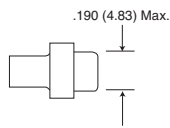
Dimensions shown in inch (mm)

www.ittcannon.com

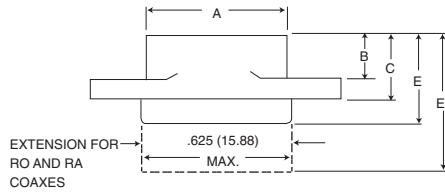
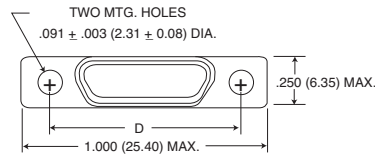
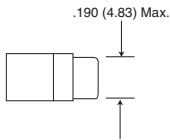
## Dimension - MDB Coaxial Series

(See page 9 for layouts)

### Plug



### Receptacle



Part Number by Shell Size	A Max.	B Max.	C Max.	D ± .005 (0.13)	E Max.	E1 Max.	Avg. Weight** (oz) ± 5% (gm.) ± 5%
<b>MDB1-7C2P*</b>	.510 (12.95)	.204 (5.18)	.298 (7.57)	.782 (19.86)	.395 (10.03)	.510 (12.95)	.290 (8.30)
<b>MDB1-7C2S*</b>	.602 (15.29)	.185 (4.70)	.279 (7.09)	.782 (19.86)	.375 (9.52)	.540 (13.72)	.273 (7.80)

\* Add lead type and length, see Part Number Explanation.

\*\* Weight given is with 7 inch (177.80) insulated leads, #26 AWG silver plated copper pigtailed and RG178/U coaxials.

## Mounting Hardware Views (Sizes 9-51)

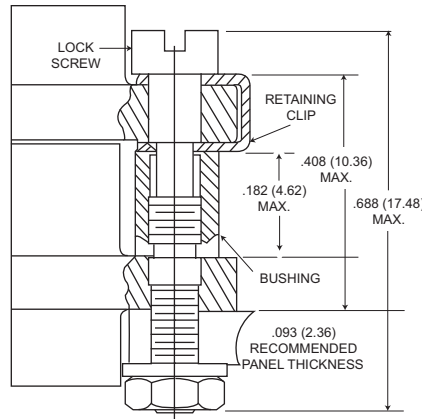
This hardware supplied unassembled.



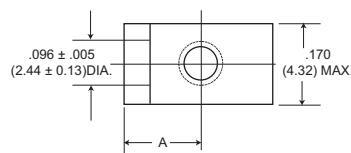
**Screw Lock Assembly**



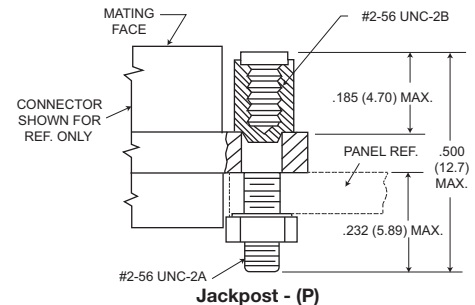
**90° Angle Mounting Bracket**



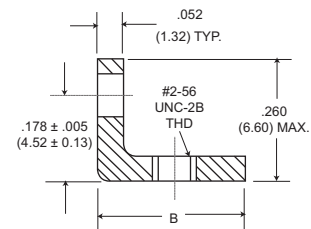
**Screw Lock Assembly\***



**90° Angle Mounting Bracket**



**Jackpost - (P)**

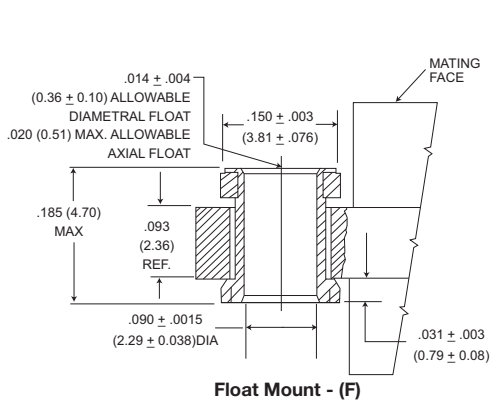


\*NOTE: Torque value is 4.0 in/lbs max.

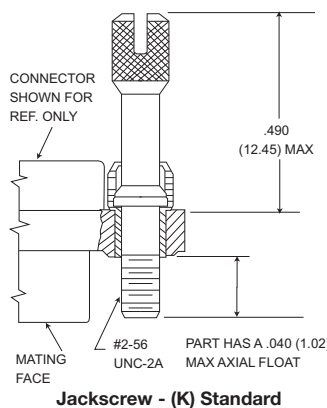
Description	Part Number	A ± .005 (0.13)	B Max.
Screw Lock Assembly	322-9500-000		
Jackpost Kit	320-9505-000		
Mounting Bracket, 90° Angle- MD*1 for 9 thru 37 Shell Sizes	015-9516-000	.100 (2.54)	.215 (5.46)
MD*1 for 51 Shell Size	015-9516-000	.122 (3.10)	.257 (6.53)

NOTES: Screw lock assembly (322-9500-000) can be used for front front mounting. Jackpost kit (320-9505-000) consists of 2 assemblies, shipped unassembled.

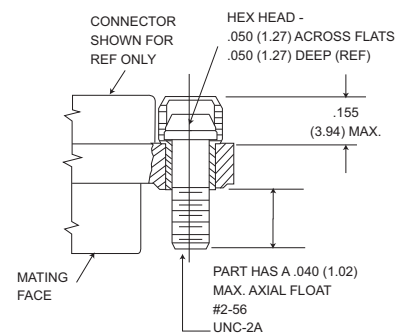
This hardware is factory installed.



**Float Mount - (F)**



**Jackscrew - (K) Standard**



**Jackscrew - (L) Low Profile**

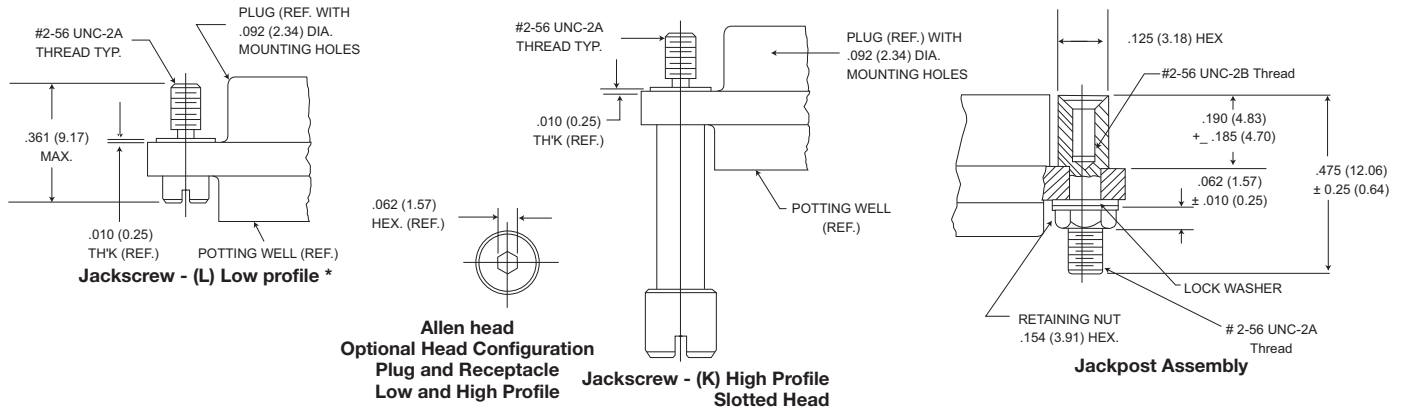
Shown here is a cutaway view of the float mount for the MD connector. The basic shell dimensions are the same for the float mount and the screw mounting hole configurations. View shown is for standard float mount front panel mounting. Reverse mounting is available on request.

\* NOTE: Torque values are as follows:  
Low Profile Jackscrew (L)-2.5 in/lbs  
Standard Jackscrew (K)-2.5 in/lbs



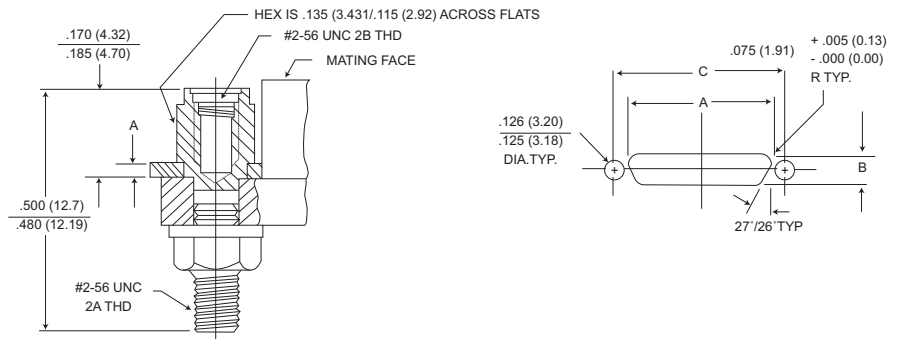
## Mounting Hardware to Military Specification (Sizes 9 - 51) PER MIL-DTL-83513/5

This hardware supplied unassembled.



Description	M83513/5	Mode Code	Part Number
Slotted Head Jackscrew Assy Low Profile	-05	M5	320-9508-025
Slotted Head Jackscrew Assy High Profile	-06	M6	320-9508-027
Allen Head Jackscrew Assy Low Profile	-02	M2	320-9508-026
Allen Head Jackscrew Assy High Profile	-03	M3	320-9508-028
Jackpost Assy	-07	M7	320-9505-033

## Jackpost Bushing (For Rear Panel Mounting)

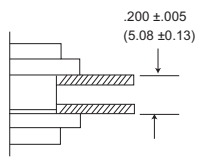


Panel Thickness	A Dim.	Jackpost Kit Number*
3/32 (2.4)	.092/.087 (2.34/2.21)	320-9505-007
1/16 (1.6)	.061/.056 (2.34/1.42)	320-9505-006
3/64 (1.2)	.047/.042 (1.19/1.07)	320-9505-005
1/32 (0.8)	.030/.025 (0.76/0.64)	320-9505-004

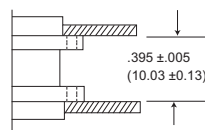
\*2 Jackposts, 2 nuts, 2 washers.  
NOTE: Torque value for jackpost 2.5 in/lbs

Shell Size	Plug and Receptacle Dimensions		
	A	B	C
	+.004 (0.10) -.000 (0.00)	+.004 (0.10) -.000 (0.00)	±.005 (0.13)
9	.379 (9.63)	.219 (5.56)	.565 (14.35)
15	.529 (13.44)	.219 (5.56)	.715 (18.16)
21	.679 (17.25)	.219 (5.56)	.865 (21.97)
25	.779 (19.79)	.219 (5.56)	.965 (24.51)
31	.929 (23.60)	.219 (5.56)	1.115 (28.32)
37	1.079 (27.41)	.219 (5.56)	1.265 (32.13)
51	1.029 (26.14)	.261 (6.63)	1.215 (30.86)

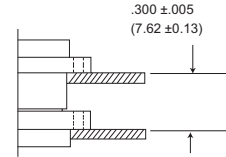
## Panel Mounting Dimensions



Plug and Receptacle Rear Mounted



Plug and Receptacle Front Mounted

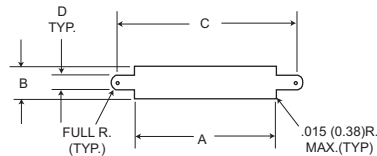


Plug Front Mounted Receptacle Rear Mounted

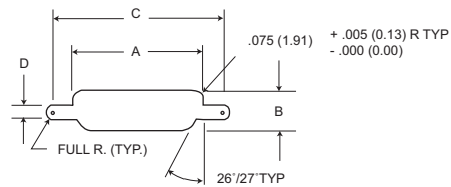
Dimensions shown in inch (mm)  
Specifications and dimensions subject to change

www.ittcannon.com

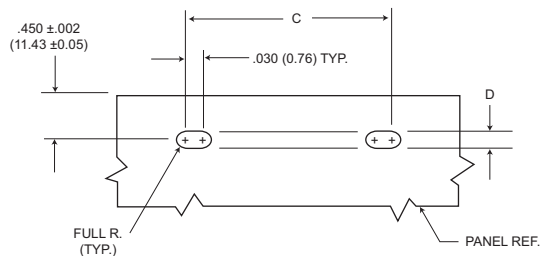




**Figure 1**  
**Front Mounting**



**Figure 2**  
**Rear Mounting**



**Figure 3**  
**Edgeboard Mounting**

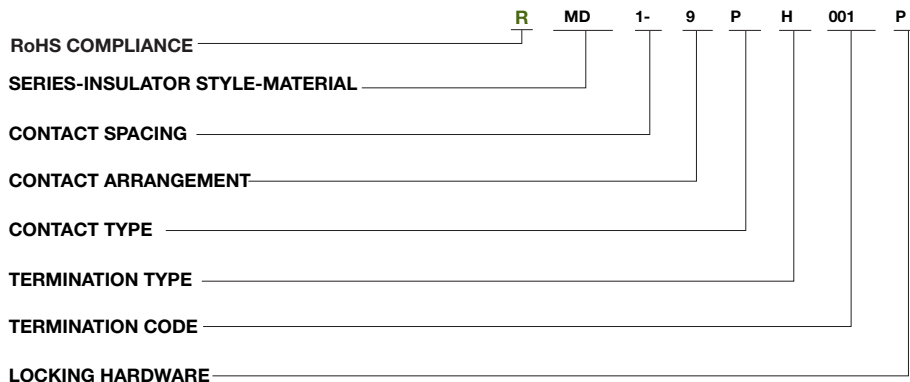
Size	Cutout Figure	A		B		C		D	
		+ .004 (0.10)	- .000 (0.00)	+ .004 (0.10)	- .000 (0.00)	+ .005 (0.13)	- .000 (0.00)	+ .005 (0.13)	- .000 (0.00)
9	1	.409 (10.39)		.172 (4.37)		.570 (14.48)		.089 (2.26)	
	2	.379 (9.63)		.219 (5.56)		.570 (14.48)		.089 (2.26)	
	3	-		-		.570 (14.48)		.089 (2.26)	
15	1	.559 (14.20)		.172 (4.37)		.720 (18.29)		.089 (2.26)	
	2	.529 (13.44)		.219 (5.56)		.720 (18.29)		.089 (2.26)	
	3	-		-		.720 (18.29)		.089 (2.26)	
21	1	.709 (18.00)		.172 (4.37)		.870 (22.10)		.089 (2.26)	
	2	.679 (17.25)		.219 (5.56)		.870 (22.10)		.089 (2.26)	
	3	-		-		.870 (22.10)		.089 (2.26)	
25	1	.809 (20.55)		.172 (4.37)		.970 (24.64)		.089 (2.26)	
	2	.779 (19.79)		.219 (5.56)		.970 (24.64)		.089 (2.26)	
	3	-		-		.970 (24.64)		.089 (2.26)	
31	1	.959 (24.36)		.172 (4.37)		1.120 (28.45)		.089 (2.26)	
	2	.929 (23.60)		.219 (5.56)		1.120 (28.45)		.089 (2.26)	
	3	-		-		1.120 (28.45)		.089 (2.26)	
37	1	1.109 (28.17)		.172 (4.37)		1.270 (32.26)		.089 (2.26)	
	2	1.079 (27.41)		.219 (5.56)		1.270 (32.26)		.089 (2.26)	
	3	-		-		1.270 (32.26)		.089 (2.26)	
51	1	1.059 (26.90)		.215 (5.46)		1.220 (30.99)		.089 (2.26)	
	2	1.029 (26.14)		.261 (6.63)		1.220 (30.99)		.089 (2.26)	
	3	-		-		1.220 (30.99)		.089 (2.26)	

**NOTES:**

1. Front mounting (figure 1) and rear mounting (figure 2) accommodates #2-56 screws.
2. Front mounting is preferred. However, when rear mounting is necessary, use detail on previous page.
3. Edgeboard mounting bracket (figure3) uses #2-56 screws. Dimension .450 ± .002 (11.43 ± 0.05) locates the MD receptacle flush with the end of the board.

## How to Order

PCB ordering information - page 30



### SERIES-INSULATOR STYLE-MATERIAL

MD - Clip mounting -Diallyl phthalate  
MDV - Clip mounting-Polyester

### CONTACT SPACING

1 - .050 (1.27) centers

### CONTACT ARRANGEMENT

9-15-21-25-31\*-37-51. See page 7

### CONTACT TYPE

P - Pin S - Socket

### TERMINATION TYPE

H - Insulated solid or stranded wire  
L - Uninsulated solid wire  
S - Solder pot to accept #26 AWG max. harness wire.

### TERMINATION CODE\*\*

(H) 001 - 18", 7/34 strand, #26 AWG, MIL-W-16878/4, Type E Teflon, Yellow.  
(H) 003 - 18", 7/34 strand, #26 AWG, MIL-W-16878/4, Type E Teflon, color coded to MIL-STD-681 System I.  
(L) 1 - 1/2" uninsulated solid #25 AWG gold plated copper.  
(L) 2 - 1" uninsulated solid #25 AWG gold plated copper.  
No designator - No hardware - standard mounting  
.091 (2.31) hole diameter

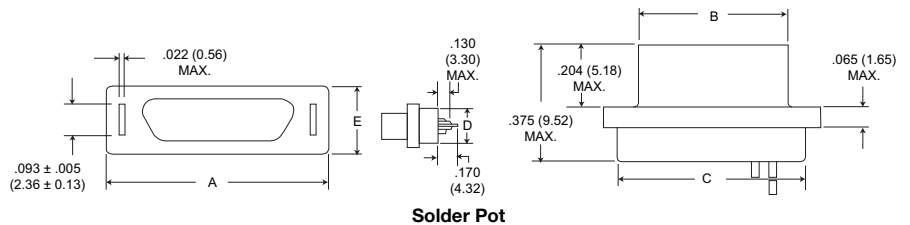
\* Not available in clip mounting.  
\*\* See page 79 and 81 for additional codes.

## With Clip Mounting Slots

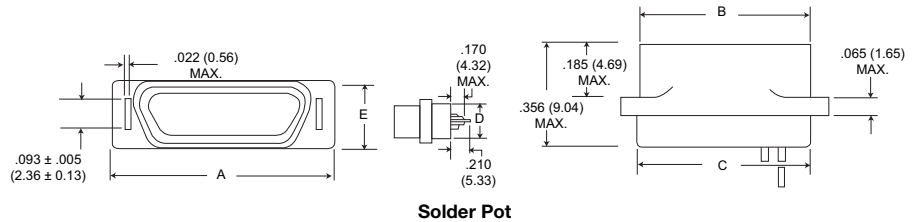
### Plug

**MD** Glass-filled Diallyl Phthalate Plastic Insulator

**MDV** Glass-filled Polyester Plastic Insulator



### Receptacle



Part Number by Shell Size	A Max.	B Max.	C Max.	D Max.	E Max.	Avg. Weight*** ±5% (oz.)/±5% (gm.)
MD1-9P** MDV1-9-P**	.512 (13.00)	.292 (7.42)	.405 (10.29)	.170 (4.32)	.215 (5.46)	.026 (0.73)
MD1-9S** MDV1-9S**	.512 (13.00)	.376 (9.55)	.405 (10.29)	.170 (4.32)	.215 (5.46)	.026 (0.73)
MD1-15P** MDV1-15P**	.662 (16.81)	.442 (11.23)	.555 (14.10)	.170 (4.32)	.215 (5.46)	.038 (1.10)
MD1-15S** MDV1-15S**	.662 (16.81)	.526 (13.36)	.555 (14.10)	.170 (4.32)	.215 (5.46)	.035 (1.00)
MD1-21P** MDV1-21P**	.812 (20.62)	.592 (15.04)	.705 (17.91)	.170 (4.32)	.215 (5.46)	.053 (1.50)
MD1-21S** MDV1-21S**	.812 (20.62)	.676 (17.17)	.705 (17.91)	.170 (4.32)	.215 (5.46)	.050 (1.40)
MD1-25P** MDV1-25P**	.912 (23.16)	.692 (17.58)	.805 (20.45)	.170 (4.32)	.215 (5.46)	.063 (1.80)
MD1-25S** MDV1-25S**	.912 (23.16)	.776 (19.71)	.805 (20.45)	.170 (4.32)	.215 (5.46)	.056 (1.60)
MD1-37P** MDV1-37P**	1.212 (30.78)	.992 (25.20)	1.105 (28.07)	.170 (4.32)	.215 (5.46)	.086 (2.45)
MD1-37S** MDV1-37S**	1.212 (30.78)	1.076 (27.33)	1.105 (28.07)	.170 (4.32)	.215 (5.46)	.076 (2.15)
MD1-51P** MDV1-51P**	1.162 (29.51)	.942 (23.93)	1.055 (26.80)	.213 (5.41)	.258 (6.55)	1.09 (3.10)
MD1-51S** MDV1-51S**	1.162 (29.51)	1.026 (26.06)	1.055 (26.80)	.213 (5.41)	.258 (6.55)	.093 (2.65)

\*\* Add lead type and length, see Part Number Explanation. \*\*\* Weight given is with 1/2", uninsulated solid #25 AWG gold plated copper pigtailed.

Dimensions shown in inch (mm)

Specifications and dimensions subject to change

www.ittcannon.com



## Panel Mounting Hardware

### Clip Mounting

Illustrated is the recommended method of front mounting with metal panel mounting keys. Panel mounting keys are available with or without coupling retention clips.

For front mounting, place the rear of the connector thru the panel cutout. With the mounting flange against the panel, fully insert the panel mounting keys thru the slots in the flange and thru the panel cutout. Retaining the keys in this position, bend them outward against the rear of the panel. When mating a front mounted connector with an unmounted connector, a coupling retention clip assembly may be used to securely lock the two together. Mounting screw brackets are available and may be used instead of the panel mounting keys.



**Coupling Retention Clip**  
(see Figure 2)



**Mounting Screw Brackets**  
(see Figures 1 and 3)



**Edgeboard Mounted**  
(see Figure 4)



**Panel Mounting Key**

Description	Part Number
Panel Mounting Key	201-9100-000
Mounting Key and Coupling Clip Assembly	294-9100-000
Mounting Screw Bracket	015-9100-000
* Edgeboard Mounting Bracket	015-5009-000

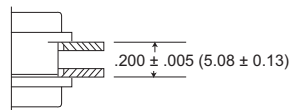
\*\* Edgeboard Mounting Bracket and

Coupling Clip Assembly **MD51428-1**

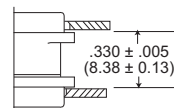
\* Must be ordered separately; specify left and right hand for complete assembly.

\*\* Must be ordered separately; assembly contains set of left and right hand types.

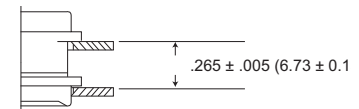
### Dimensions (Clip Mounting Only)



**Plug and Receptacle Rear Mounted**

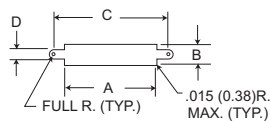


**Plug and Receptacle Front Mounted**



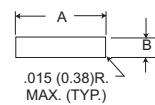
**Plug Front Mounted Receptacle Rear Mounted**

## Panel Cutouts

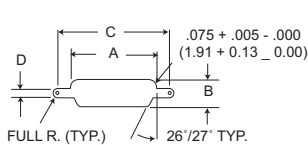


**Figure 1**

### Front Mounting

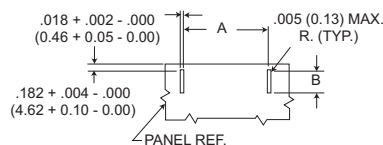


**Figure 2**



**Figure 3**

### Rear Mounting



**Figure 4**

### Edgeboard Mounting

1. A panel thickness of 1/8" (3.17mm) maximum is recommended for ease of tab bending when a panel mounting key & clip assembly or edgeboard mounting brackets are used.
2. Front mounting is preferred. However, when rear mounting is necessary, use figure 3 for dimensions.
3. Figure 4 is for edge board mounting bracket or edgeboard clip assembly. The .184 + .002 (2.67 + .05) dimension locates the MD socket insulator flush with the end of the board.
4. Screw brackets (015-9100-000) will accommodate #2-56 screws.
5. Front mounting (Figure 1) and rear mounting (Figure 3) accommodate #2-56 screws.

Shell Size	Cutout Figure	A	B	C	D
		+ .004 (0.10) - .000 (0.00)	+ .004 (0.10) - .000 (0.00)	+ .004 (0.10) - .000 (0.00)	+ .005 (0.13) - .000 (0.00)
9	1	.408 (10.36)	.172 (4.37)	.650 (16.51)	.089 (2.26)
	2	.408 (10.36)	.172 (4.37)	-	-
	3	.378 (9.60)	.217 (5.51)	.650 (16.51)	.089 (2.26)
	4	.400 (10.16)	.091 (2.31)	-	-
15	1	.588 (14.94)	.172 (4.37)	.795 (20.19)	.089 (2.26)
	2	.588 (14.94)	.172 (4.37)	-	-
	3	.528 (13.28)	.217 (5.51)	.795 (20.19)	.089 (2.26)
	4	.550 (13.97)	.091 (2.31)	-	-
21	1	.738 (18.75)	.172 (4.37)	.945 (24.00)	.089 (2.26)
	2	.738 (18.75)	.172 (4.37)	-	-
	3	.678 (17.27)	.217 (5.51)	.945 (24.00)	.089 (2.26)
	4	.700 (17.78)	.091 (2.31)	-	-
25	1	.838 (21.29)	.172 (4.37)	1.045 (26.54)	.089 (2.26)
	2	.838 (21.29)	.172 (4.37)	-	-
	3	.778 (19.76)	.217 (5.51)	1.045 (26.54)	.089 (2.26)
	4	.800 (20.32)	.091 (2.31)	-	-
37	1	1.138 (28.91)	.172 (4.37)	1.345 (34.16)	.089 (2.26)
	2	1.138 (28.91)	.172 (4.37)	-	-
	3	1.078 (27.38)	.217 (5.51)	1.345 (34.16)	.089 (2.26)
	4	1.100 (27.94)	.091 (2.31)	-	-
51	1	1.088 (27.64)	.215 (5.46)	1.295 (32.89)	.089 (2.26)
	2	1.088 (27.64)	.215 (5.46)	-	-
	3	1.028 (26.11)	.260 (6.60)	1.295 (32.89)	.089 (2.26)
	4	1.050 (26.67)	.091 (2.31)	-	-



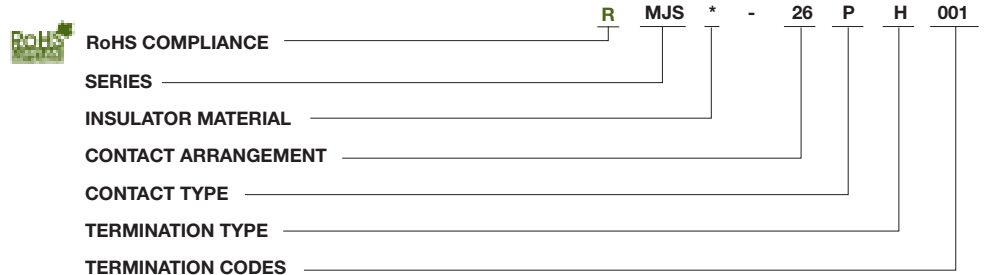
Dimensions shown in inch (mm)  
Specifications and dimensions subject to change

www.ittcannon.com



The MJS jackscrew series provides a reliable interconnect for board-to-board, board-to-cable and in-line cable-to-cable applications. Layouts accommodating up to 76 MICROPIN/MICROSOCKET™ contacts are available, with the same wide range of options as are offered with the other MICRO Line products offered in this catalog.

## How to Order



### SERIES

MJS - Micro Center Jackscrew

### INSULATOR MATERIAL

- B - Diallyl phthalate
- V - Polyester
- U - Polyetherimide
- R - Polyphenylene sulfide

### CONTACT ARRANGEMENTS

- Unshrouded Receptacle: 10, 26, 51, 66
- Shrouded Receptacle: 10, 26, 34, 38, 42, 76
- Low Profile Plug and Receptacle (shrouded): 28

### CONTACT TYPE

- P - Pin
- S - Socket

### TERMINATION TYPE

- H - Insulated wire harness.
- I - Integral tail (MJSV-28S only).
- L - Solid - uninsulated wire.
- S - Solder pot to accept #26 AWG harness wire.
- T - Thru bundle pigtail (MJSV-28P only).

### TERMINATION CODE\*

- (H) 001 - 18" , 7/34 strand, #26 AWG, MIL-W-16878/4, Type E Teflon, yellow.
- (H) 003 - 18" , 7/34 strand, #26 AWG, MIL-W-16878/4, Type E Teflon, color coded to MIL-STD-681 System I.
- (L) 1 - 1/2" uninsulated solid #25 AWG gold plated copper.
- (L) 2 - 1" uninsulated solid #25 AWG gold plated copper.

\* See Termination Codes shown below.

## Standard Wire Termination Codes

The following termination codes are listed for your information. For additional codes please refer to Appendix on page 79 and 81. **All wire lengths are minimum.**

### Harness Type (H)

#26 AWG per MIL-W-16878/4 Type E Teflon, 7/34 stranded.

Length	All Yellow	Color Coded
3 (76.2)	H 020	H 027
6 (152.4)	H 019	H 016
8 (203.2)	H 026	H 034
10 (254.0)	H 029	H 025
12 (304.8)	H 028	H 002
18 (457.2)	H 001	H 003
20 (508.0)	H 038	H 023

Length	All Yellow	Color Coded
24 (609.6)	H 009	H 004
30 (762.0)	H 010	H 005
36 (914.4)	H 011	H 006
48 (1219.2)	H 013	H 048
72 (1828.8)	H 017	H 046
120 (3048.0)	H 042	H 041

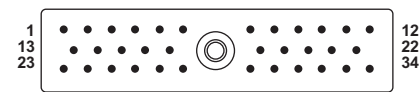
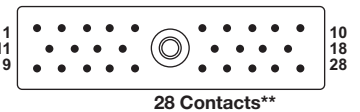
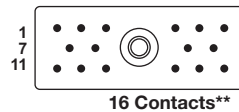
### Solid Uninsulated Type (L)

#25 AWG gold plated solid copper.

Termination Code	Length	Termination Code	Length
L61	.125 (3.18)	L14	.750 (19.05)
L56	.150 (3.81)	L2	1.000 (25.40)
L57	.190 (4.83)	L7	1.500 (38.10)
L39	.250 (6.35)	L6	2.000 (50.80)
L58	.375 (9.53)	L16	2.500 (63.50)
L1	.500 (12.70)	L10	3.000 (76.20)

## Contact Arrangements

### Face view of pin-use reverse order for socket



MJSB/MJSU (unshrouded)

MJSV (shrouded)

Identification numbers are for reference only and do not appear on connectors.

\*Low profile configuration  
\*\*MJSV & MJSR

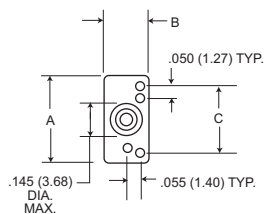
Dimensions shown in inch (mm)  
Specifications and dimensions subject to change

www.ittcannon.com

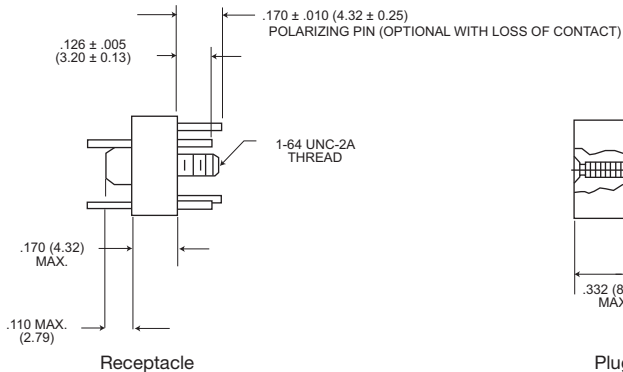


## Unshrouded Receptacle (10-26-51-66)

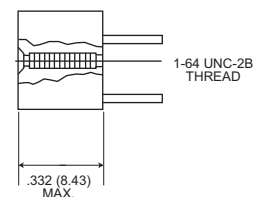
### MJSB/MJSU



Rear View



Receptacle



Plug

### UNSHROUDED

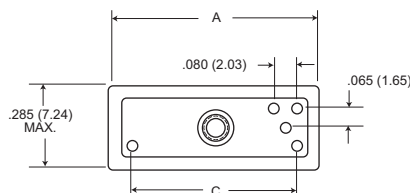
#### STANDARD MATERIALS AND FINISHES

Micropin	Copper alloy, 50 micro-inch gold
Microsocket	Copper alloy, 50 micro-inch gold
Insulator	Diallyl phthalate, green color or polyetherimide, natural color
Jackscrew	Stainless steel, passivated & lubricated
Retainer, Jackscrew	Stainless steel, passivated
Insert, Threaded	Stainless steel, passivated
Post, Polarizing	Stainless steel, passivated

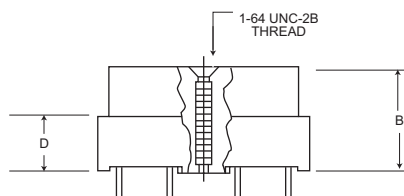
Part Number	A Max.	B Max.	C Bsc.
<b>MJSB or MJSU-10P</b>	.378 (9.60)	.190 (4.83)	.290 (7.37)
<b>MJSB or MJSU-10S</b>	.378 (9.60)	.190 (4.83)	.290 (7.37)
<b>MJSB or MJSU-26P</b>	.778 (19.76)	.190 (4.83)	.690 (17.53)
<b>MJSB or MJSU-26S</b>	.778 (19.76)	.190 (4.83)	.690 (17.53)
<b>MJSB or MJSU-51P</b>	1.028 (26.11)	.260 (6.60)	.940 (23.88)
<b>MJSB or MJSU-51S</b>	1.028 (26.11)	.260 (6.60)	.940 (23.88)
<b>MJSB or MJSU-66P</b>	1.280 (32.51)	.260 (6.60)	1.190 (30.23)
<b>MJSB or MJSU-66S</b>	1.280 (32.51)	.260 (6.60)	1.190 (30.23)

## Shrouded Receptacle (16-28\*-34)

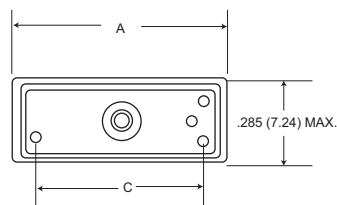
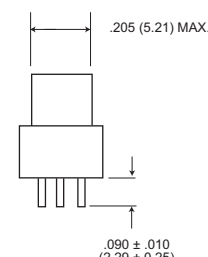
### MJSV/MJSR



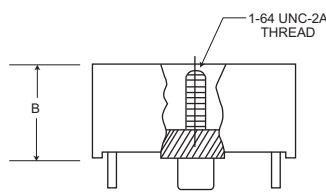
Face View



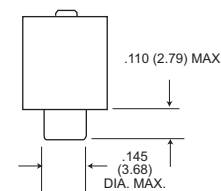
Plug



Face View



Receptacle



### SHROUDED

#### STANDARD MATERIALS AND FINISHES

Micropin	Copper alloy, 50 micro-inch gold
Microsocket	Copper alloy, 50 micro-inch gold
Insulator	Polyester, black color or Polyphenylene sulfide, black color
Jackscrew	Stainless steel, passivated
Retainer, Jackscrew	Stainless steel, passivated
Insert, Threaded	Stainless steel, passivated
Post, Polarizing	Stainless steel, passivated

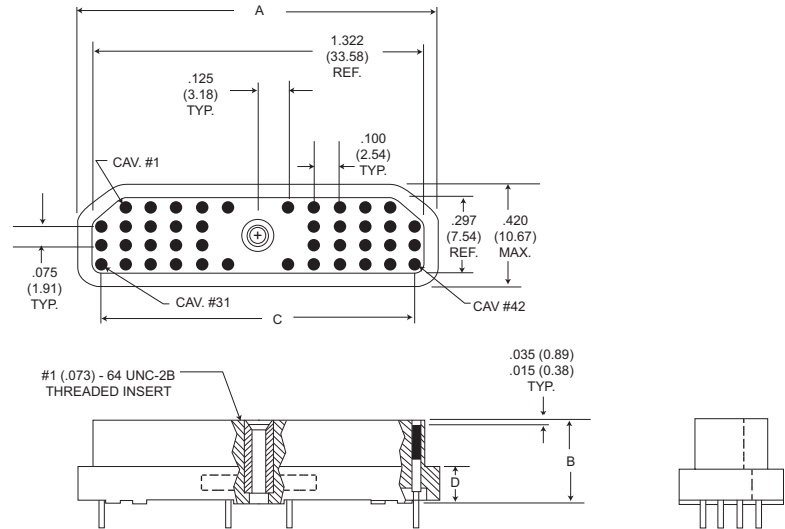
Part Number	A Max.	B Max.	C Ref.	D ± .006 (0.15)
<b>MJSV or MJSR-16P</b>	.700 (17.78)	.345 (8.76)	.545 (13.84)	.175 (4.45)
<b>MJSV or MJSR-16S</b>	.700 (17.78)	.320 (8.13)	.545 (13.84)	-
<b>MJSV-28P* or MJSR-28P*</b>	1.020 (25.91)	.232 (5.89)	.865 (21.97)	.062 (1.57)
<b>MJSV-28S* or MJSR-28S*</b>	1.020 (25.91)	.246 (6.25)	.865 (21.97)	-
<b>MJSV-34P or MJSR-34P</b>	1.180 (29.97)	.330 (8.38)	1.025 (26.04)	.160 (4.06)
<b>MJSV-34S or MJSR-34S</b>	1.180 (29.97)	.305 (7.75)	1.025 (26.04)	-

\*Low profile configuration, for "L" (uninsulated solid wire) termination add .090 (2.29) to the "B" dimension. For "H" (insulated wire) termination add .200 (5.08) to the "B" dimension. For special configurations with backpotted standoff consult factory.

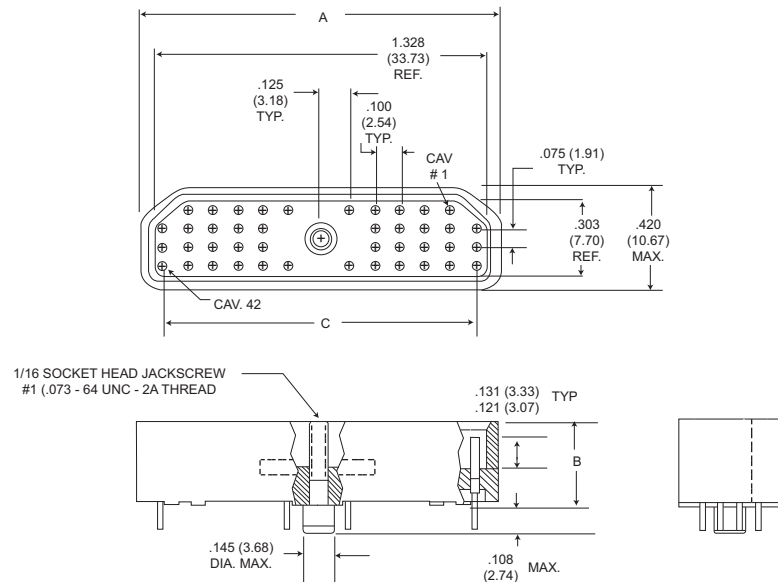


## Shrouded Receptacle (42)

### MJSR-42P



### MJSR-42S



Part Number	A Max.	B Max.	C Ref.	D ±.006 (0.15)
MJSR-42P	1.445 (36.70)	.345 (8.76)	1.250 (31.75)	.142 (3.61)
MJSR-42S	1.445 (36.70)	.357 (9.07)	1.250 (31.75)	-

#### STANDARD MATERIALS AND FINISHES

Micropin	Copper alloy, 50 micro-inch gold
Microsocket	Copper alloy, 50 micro-inch gold
Insulator	Polyphenylene sulfide, black color
Jackscrew	Stainless steel, passivated
Retainer, Jackscrew	Stainless steel, passivated
Insert, Threaded	Stainless steel, passivated

Dimensions shown in inch (mm)

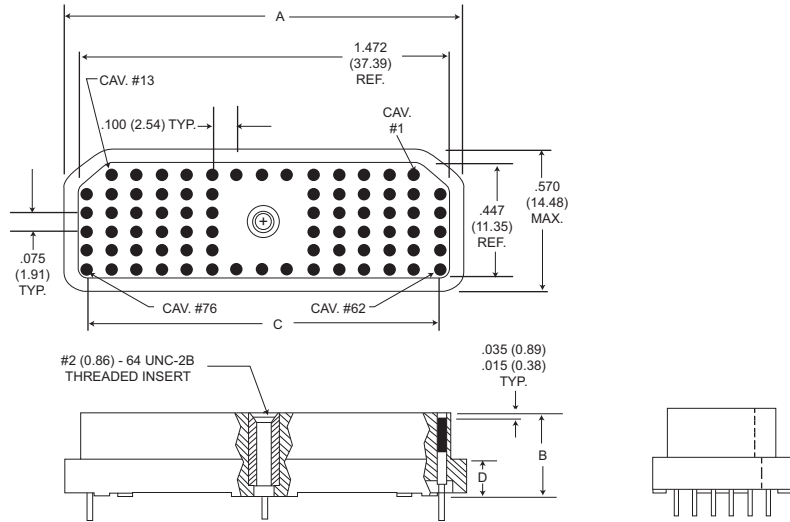
Specifications and dimensions subject to change

www.ittcannon.com

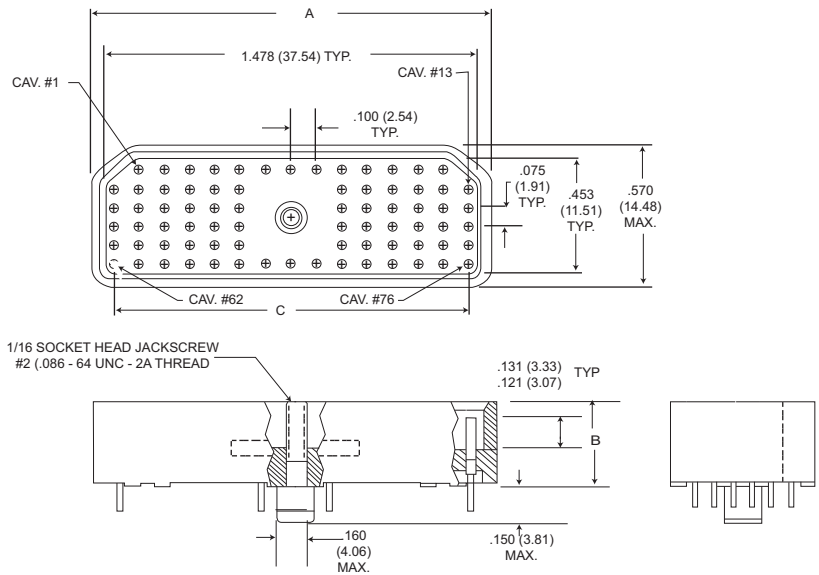


## Shrouded Receptacle (76)

### MJSR-76P



### MJSR-76S



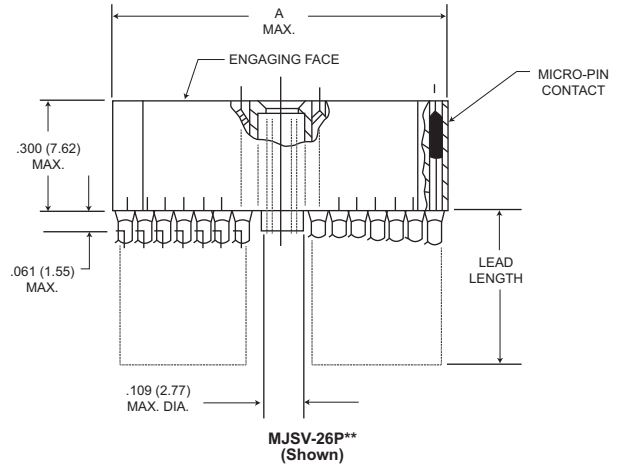
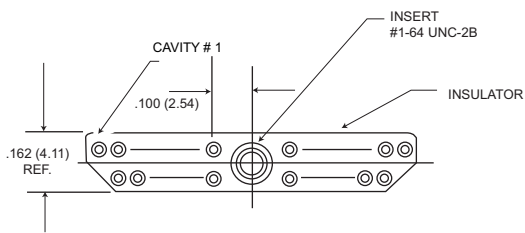
Part Number	A Max.	B Max.	C Ref.	D ±.006 (0.15)
MJSR-76P	1.595 (40.51)	.345 (8.76)	1.400 (35.56)	.142 (3.61)
MJSR-76S	1.595 (40.51)	.357 (9.07)	1.400 (35.56)	-

### STANDARD MATERIALS AND FINISHES

Micropin	Copper alloy, 50 micro-inch gold
Microsocket	Copper alloy, 50 micro-inch gold
Insulator	Polyphenylene sulfide, black color
Jackscrew	Stainless steel, passivated
Retainer, Jackscrew	Stainless steel, passivated
Insert, Threaded	Stainless steel, passivated

## Plug (Molded-In Insert - Special)

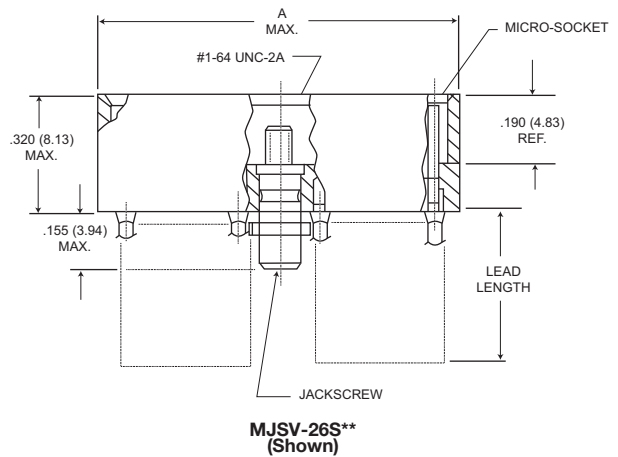
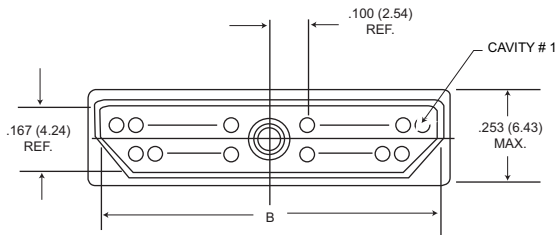
MJSV\*\*P



Part Number	A Ref.
MJSV-26P**	.868 (22.05)
MJSV-38P**	1.168 (29.67)

## Receptacle (Special)

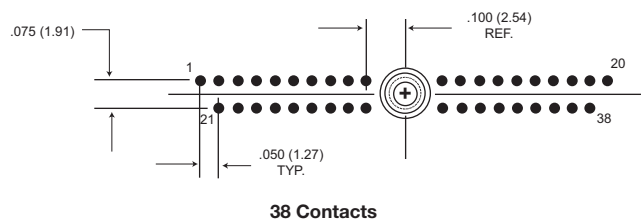
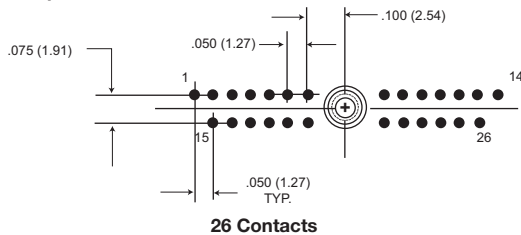
MJSV\*\*S\*



Part Number	A Max.	B Ref.
MJSV-26S**	.943 (23.95)	.874 (22.20)
MJSV-38S**	1.243 (31.57)	1.174 (29.82)

## Contact Arrangements

Face view of pin - use reverse order for socket



Identification numbers are for reference and do not appear on connectors.

Dimensions shown in inch (mm)  
Specifications and dimensions subject to change

www.ittcannon.com



# Microminiature Circular - .050" Contact Spacing

# MICRO-K

MICRO-K microminiature circular connectors are rugged yet lightweight - and meet or exceed the applicable requirements of MIL-DTL-83513. Applications include biomedical, instrumentation and miniature black boxes.

**MIK:** Accommodate up to 55 contacts on .050 (1.27) centers (equivalent to 420 contacts per square inch). Five keyway polarization prevents cross plugging. The threaded coupling nuts provide strong, reliable coupling. MIK receptacles can be either front or back panel mounted; in back mounting applications, panel thickness of up to 3/32" can be used on the larger sizes. Maximum temperature range - 55°C to + 125°C.

Standard MIK connectors are available in two shell sizes accommodating two contact arrangements pre-wired to your specific requirements.

**MIKM:** Similar to our MIK, except has a steel shell and receptacle for improved ruggedness and RFI resistance. It accommodates up to 85 twist pin contacts. Maximum temperature range - 55°C to + 125° C.

**MIKQ:** A quick disconnect metal shell and receptacle version that can be instantaneously disconnected yet provides a solid lock when engaged. Applications include commercial TV cameras, portable

radios, military gun sights, airborne landing systems and medical equipment. Maximum temperature range - 55°C to +125°C.



## Specifications

### STANDARD MATERIAL AND FINISHES

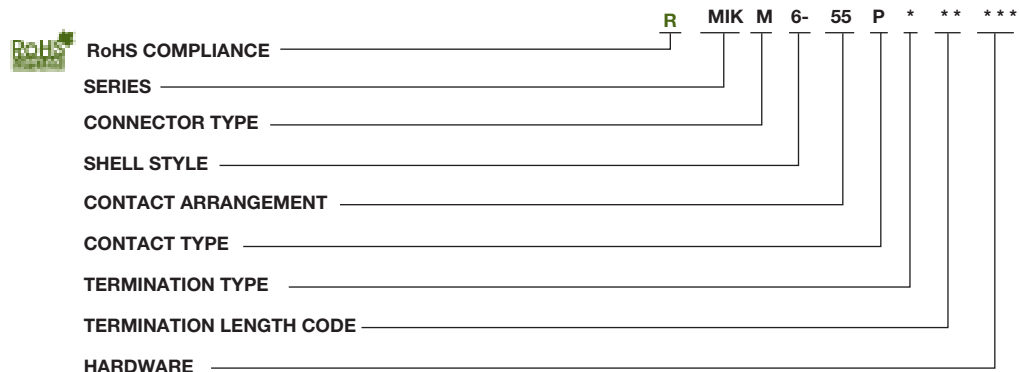
	MIK	MIKM	MIKQ
Shell	Thermoplastic	Stainless Steel	Brass
Coupling Nut	Stainless Steel Passivated	Stainless Steel Passivated	Brass, Electroless Nickel Plated*
Insulator	Glass-reinforced Thermoplastic	Glass-reinforced Thermoplastic	Glass-reinforced Thermoplastic
Contacts	50 Microinch Gold Plated Copper Alloy	50 Microinch Gold Plated Copper Alloy	50 Microinch Gold Plated Copper Alloy

\*For plug only  
Electrodeposited for receptacle.

### ELECTRO/MECHANICAL FEATURES

	MIK	MIKM	MIKQ
No. of Contacts	7,55	7,55, 85	7,19, 37
Wire Size	#24 AWG thru #32 AWG	#24 AWG thru #32 AWG	#24 AWG thru #32 AWG
Contact Termination	Crimp	Crimp	Crimp
Contact Rating	3 Amps	3 Amps	3 Amps
Coupling	Threaded	Threaded	Push/Pull
Polarization	Keyways	Keyways	Keyways
Contact Spacing	.050 (1.27) Centers	.050 (1.27) Centers	.050 (1.27) Centers
Shell Styles	0-Wall Mtg. 6-Straight Plug	0-Wall Mtg. 6-Straight Plug	7-Jam Nut 6-Straight Plug 9-Rear Panel Mtg. Receptacle

## How to Order



### SERIES

MIK: Microminiature Circular

### CONNECTOR TYPES

No Letter - Screw coupling, plastic shell  
M - Screw coupling, metal shell  
Q - Push/Pull, metal shell

### SHELL STYLES

0 - Wall mounting receptacle (MIK and MIKM only)  
6 - Straight plug (MIK, MIKM and MIKQ)  
7 - Jam nut mount (MIKQ only)  
9 - Rear panel mounted receptacle (MIKQ)

### CONTACT ARRANGEMENTS

7, 19, 37, 55, 85

### CONTACT TYPE

P - Pin  
S - Socket

### TERMINATION TYPES

H - Insulated round hook-up wire  
L - Uninsulated round solid wire

### TERMINATION LENGTH CODE (STANDARDS)

(H) 001 - 18", 7/34 strand, #26 AWG, MIL-W-16878/4, Type E Teflon, yellow.  
(H) 003 - 18", 7/34 strand, #26 AWG, MIL-W-16878/4, Type E Teflon, color coded to MIL-STD-681 System I.  
(L) 1 - 1/2" uninsulated solid #25 AWG gold plated copper.  
(L) 2 - 1" uninsulated solid #25 AWG gold plated copper.

### HARDWARE

G - Cable nut and grip (MIKQ plug only)  
N - Nut only (MIKQ plug only)

NOTE: Contact types cannot be interchanged between shell styles.



Dimensions shown in inch (mm)  
Specifications and dimensions subject to change

www.ittcannon.com

## Standard Wire Termination Codes

The following termination codes are listed for your information. For additional codes please refer to Appendix on page 79 and 81. **All wire lengths are minimum.**

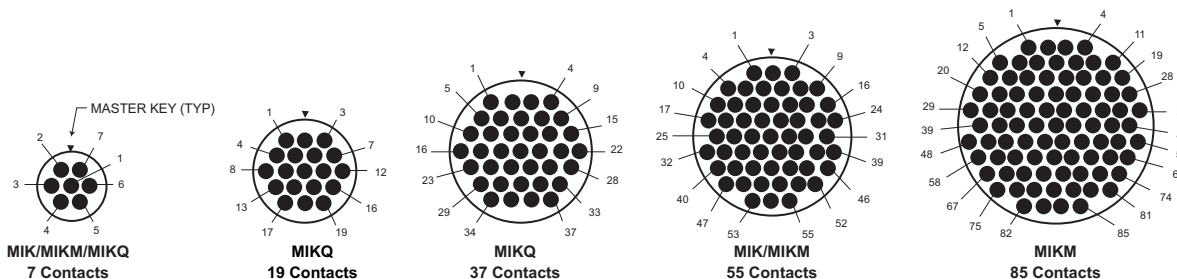
### HARNESS TYPES (H)

#26 AWG per MIL-W-16878 Type E, Teflon Stranded

Length	-All Yellow	Color Coded
3 (76.2)	020	027
6 (152.4)	019	016
8 (203.2)	026	034
10 (254.0)	029	025
12 (304.8)	028	002
18 (457.2)	001	003
20 (508.0)	038	023
24 (609.6)	009	004
30 (762.0)	010	005
36 (914.4)	011	006
48 (1219.2)	013	048
72 (1828.8)	017	046
120 (3048.0)	042	041

## Contact Arrangements

### Face View, Pin Side-(Male Twist Pin Contacts)

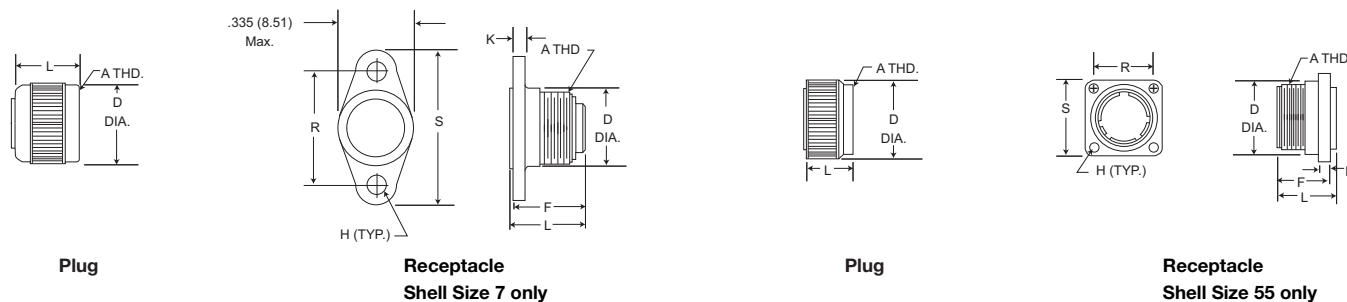


Cavity identification numbers are for reference only, they do not appear on connectors.

## Shell Dimensions

### MIK (Rear Panel Mount Thickness - see Tabulation "T")

Weight given is 1/2" uninsulated, solid #25 AWG gold plated copper pigtails



Plug Part Number by Shell Size	A Thread	D Max.	L Max.	Avg. Weight oz. (gm.) ±5%
MIK6-7P	5/16-24UNF-2B	.375 (9.52)	.315 (8.00)	.054 (1.54)
MIK6-55P	9/16-24UNF-2A	.755 (19.18)	.460 (11.68)	.202 (5.72)

### Receptacle

Part Number by Shell Size	A Thread	D ±.010 (0.25) Max.	F Max.	H ±.003 (0.08) Max.	K ±.010 (0.25) Max.	L Max.	R ±.005 (0.13) Max.	S Max.	T Max.	Avg. Weight oz. (gm.) ± 5%
MIK0-7S	5/16-24UNF-2B	.325 (8.26)	.315 (8.00)	.078 (1.98)	.062 (1.57)	.355 (9.02)	.460 (11.68)	.630 (16.00)	.032 (0.81)	.022 (.635)
MIK0-55S	9/16-24UNF-2A	.625 (15.88)	.440 (11.18)	.089 (2.26)	.100 (2.54)	.495 (12.57)	.580 (14.73)	.760 (19.30)	.062 (1.57)	.134 (3.81)

Dimensions shown in inch (mm)

Specifications and dimensions subject to change

www.ittcannon.com

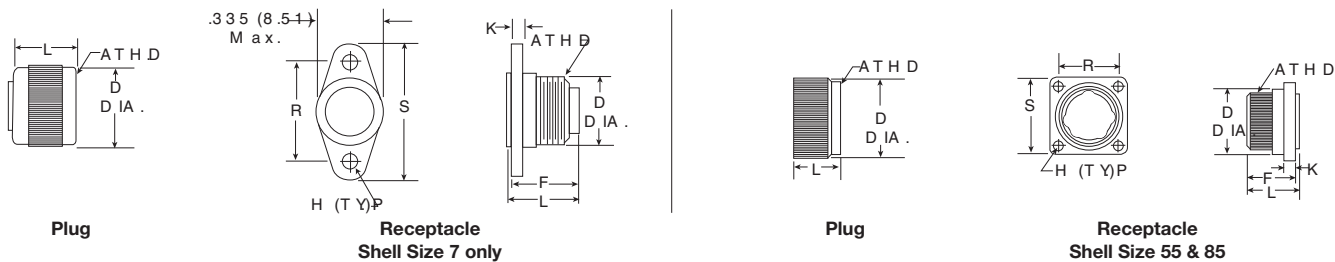


# Microminiature Circular - .050" Contact Spacing

# MIKM/MIKQ

## Shell Dimensions (Continued)

MIKM (Rear Panel Mount Thickness .335 (8.51) max. - see Tabulation "T")



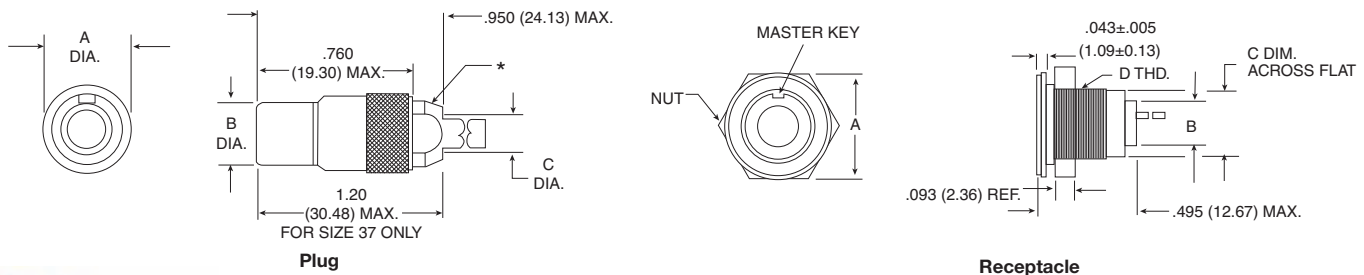
### Plug

Part Number by Shell Size	A Thread	D Max.	L Max.	Avg. Weight oz. (gm.)±5%
MIKM6-7P	5/16-24UNF-2A	.375 (9.52)	.315 (8.00)	.054 (1.54)
MIKM6-55P	5/8-24UNEF-2B	.775 (19.18)	.440 (11.18)	.333 (9.44)
MIKM6-85P	11/16-24UNEF-2B	.860 (21.84)	.460 (11.68)	.419 (11.88)

### Receptacle

Part Number by Shell Size	A Thread	D	F Max.	H ± .003 (0.08)	K	L Max.	R ± .005 (0.13)	S Max.	T Max.	Avg. Weight oz. (gm.)±5%
MIKM0-7S	5/16-24UNF-2A	.325 (8.26)	.320 (8.13)	.078 (1.98)	.062 (1.57)	.400 (10.16)	.460 (11.68)	.630 (16.00)	.032 (0.81)	.051 (1.45)
MIKM0-55S	5/8-24UNEF-2A	.625 (15.88)	.440 (11.18)	.091 (2.31)	.062 (1.57)	.490 (12.45)	.580 (14.73)	.760 (19.30)	.125 (3.18)	.269 (7.62)
MIKM0-85S	11/16-24UNEF-2A	.745 (18.92)	.440 (11.18)	.091 (2.31)	.062 (1.57)	.490 (12.45)	.674 (17.12)	.845 (21.46)	.125 (3.18)	.346 (9.80)

MIKQ (Front Panel Mounting Type Shown-.093 (2.36) Thickness)



### Plug

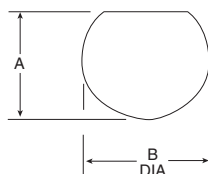
Part Number by Shell Size	A MAX.	B MAX.	C Ref.	Avg. Weight oz. (gm.)±5%
MIKQ6-7S	.385 (9.78)	.305 (7.75)	.180 (4.57)	.214 (6.08)
MIKQ6-19S	.515 (13.08)	.405 (10.29)	.260 (6.60)	.376 (10.70)
MIKQ6-37S	.760 (19.30)	.635 (16.13)	.350 (8.89)	.714 (20.23)

\*Std. Conn. not supplied with Cable Nut & Grip, See Mod Codes. Lanyard Release Is Available. Consult factory.

### Receptacle

Part Number by Shell Size	A MAX.	B MAX.	C MAX.	D Thread	Avg. Weight oz. (gm.)±5%
MIKQ6-7S	.510 (12.95)	.245 (6.22)	.359 (9.12)	3/8-32UNEF-2A	.128 (3.63)
MIKQ7-19P	.575 (14.60)	.345 (8.76)	.470 (11.94)	1/2-28UNEF-2A	.214 (6.08)
MIKQ7-37P	.855 (21.71)	.520 (13.20)	.740 (18.80)	3/4-20UNEF-2A	.300 (8.52)

MIKQ Front Panel Mounting



### Front Panel Mounting-MIKQ7

Shell Size	A ± .005 (0.13)	B DIA.
MIKQ7-7P	.364 (9.24)	.390 (9.91)
MIKQ7-19P	.475 (12.06)	.515 (13.08)
MIKQ7-37P	.740 (18.78)	.755 (19.17)

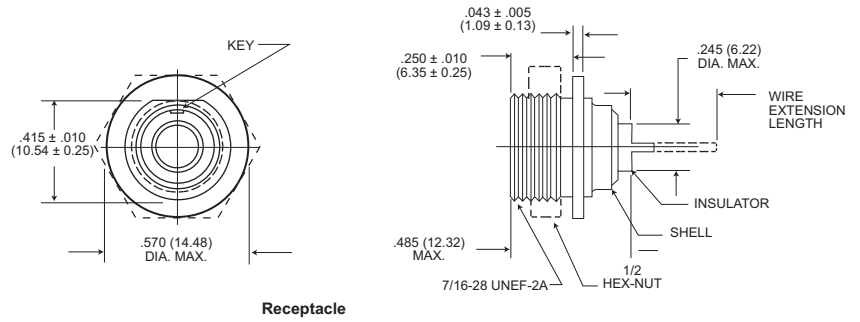


Dimensions shown in inch (mm)  
Specifications and dimensions subject to change

www.ittcannon.com

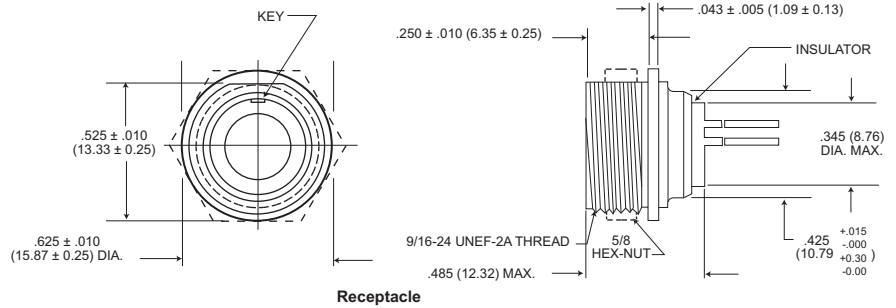
## Shell Dimensions (Continued)

### MIKQ9-7P (Back Panel Mounting)



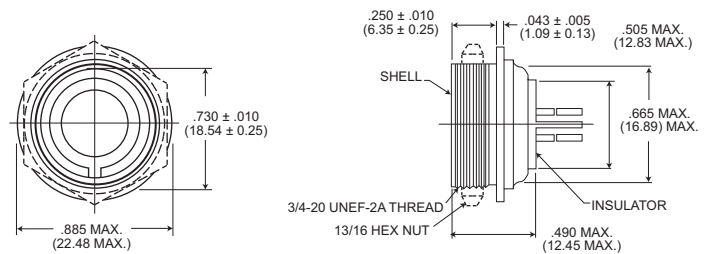
Receptacle

### MIKQ9-19P (Back Panel Mounting)



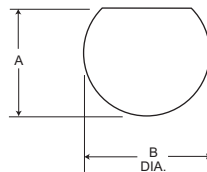
Receptacle

### MIKQ9-37P (Back Panel Mounting)



Receptacle

### MIKQ Rear Panel Mounting



### Rear Panel Mounting-MIKQ9

Shell Size	A ± .005 (0.13)	B Dia.
MIKQ9-7P	.425 (10.76)	.440 (11.18)
MIKQ9-19P	.535 (13.58)	.564 (14.33)
MIKQ9-37P	.740 (18.78)	.755 (19.17)

The Cannon Microstrips provide an extremely dense and reliable interconnection solution in a minimum profile package, giving great application flexibility. Available with latches or guide pins, Microstrips are frequently found in board-to-wire applications where high reliability is a primary concern.

Three termination styles are available: solder cup, pigtail, harness, or printed circuit leads. The MicroPin Contact System assures maximum performance in a minimum package.



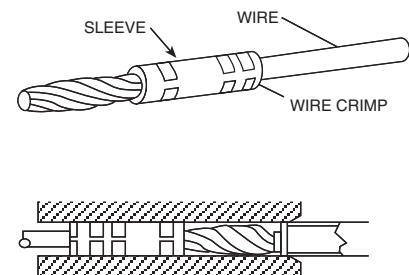
## Product Features

- High Performance MicroPin Contact System
- High-density .050" contact spacing
- Pre-wired for ease of installation
- Fully potted wire terminations
- Guide pins for alignment and polarizing
- Quick-disconnect latches
- 3 Amp current rating
- Precision crimp terminations
- Solder cup, pigtail or printed circuit terminations
- Surface mount leads

### MicroPin Contact System

The Cannon MicroPin Contact System offers uncompromised performance in downsized interconnects. The beryllium copper pin contact is fully recessed in the insulator, assuring positive contact alignment and robust performance. The socket contact is precision machined from high strength copper alloy and features a smooth lead-in chamfer.

The MicroPin features seven points of electrical contact. This contact system assures high normal force, excellent wipe and superior shock and vibration performance.



## Specifications

Current Rating	3 Amps max
Dielectric Withstanding Voltage	900 VAC @ sea level; 300 VAC @ 70,000 feet altitude
Insulation Resistance	5000 megohms min.
Contact Resistance	8 milliohms max.
Operating Temperature	MTV polyester -56°C to +125°C; MTB diallyl phthalate -55°C to +150°C
Durability	500 cycles min.
Shock/Vibration	50 G's/20 G's
Connector Mating Force	(8 oz.) x (# of contacts)
Latch Retention	5 lbs. min.
Wire Size	#26 AWG insulated wire, #25 AWG uninsulated solid wire. MT strips will also accommodate #24 AWG through #32 AWG. For other wiring options contact the factory for ordering information.
	General Performance requirements in accordance with MIL-DTL-83513

## Materials and Finishes

Insulator	MTV: Glass-filled polyester per MIL-M-24519; MTB: Glass-filled diallyl phthalate per MIL-M-14
Contact	Copper Alloy per MIL-C-83513
Contact Finish	50 Microinches Min. Gold Plated per MIL-G-45204
Insulated Wire	#26 AWG. 19/38 Stranded, silver-plated copper, TFE Teflon insulation per MIL-W-16878/4
Uninsulated Solid Wire	#25 AWG gold-plated copper per QQ-W-343
Potting Material/Contact Encapsulant	Epoxy
Latch	300 series stainless steel, passivated



Dimensions shown in inch (mm)  
Specifications and dimensions subject to change

www.ittcannon.com

## How to Order



**RoHS Compliance**

**Series**

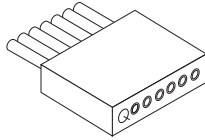
MTB1 – High Temperature Diallyl Phthalate 150°C (Recommended for severe environments)  
 MTV1 – Polyester 125°C (Recommended for general purpose use)

**Number of Cavities**

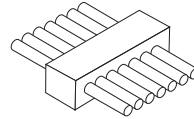
2 through 40.  
 This number is the total number of cavities including guide pins and latches. 40 positions is the maximum recommended size for standard strips, but sizes up to 120 positions are available on request.

**Contact Type**

P- Pin  
 S – Socket



Pin Strip



Socket Strip

**Termination Style**

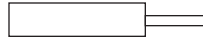
**Solder Cup** contacts for customer termination  
 S

**Pre-wired Pigtails**

H067 – Pre-wired pigtail with 18" of insulated Teflon wire per M22759/11, #26 AWG, 19 strand, yellow  
 HY01 – Pre-wired pigtail with 18" of insulated Teflon wire per M22759/11, #26 AWG, 19 strand, 10 color repeating

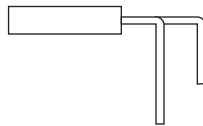
**Straight Terminals** .018" diameter, gold-plated

L1 – 5" extension  
 L2 – 1" extension  
 L57 – .190" extension  
 L61 – .125" extension



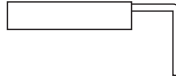
**Right Angle Terminals** staggered footprint .018" diameter, gold plated

AL57 – .190" extension  
 AL61 – .125" extension



**Right Angle Terminals** .050" in-line footprint .018" diameter, gold plated

BL57 – .190" extension  
 BL61 – .125" extension



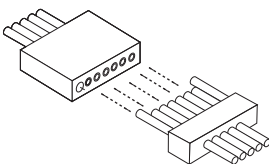
**Surface Mount** .018" diameter, gold-plated

CL1

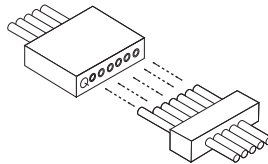


**Guide Pin and Latch Options**

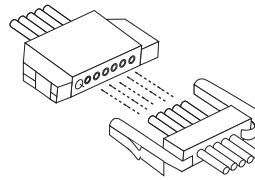
- 01 – Guide pin installed in end cavities of socket strip. Blank holes in end cavities of pin strip.
- 02 – Guide pin installed in cavity #1 of socket Strip. Blank holes in cavity #1 of pin strip.
- 03 – Spring latches installed in end cavities of socket strip. Latch clips installed in end cavities of pin strip. For use with MTV1 only.
- 04 – Spring latch installed in center cavity of socket strip. Spring latch installed in center cavity of pin strip. For use with MTV1 only.



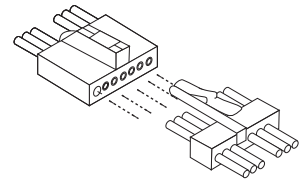
01  
 Guide Pins In End Cavities



02  
 Guide Pins In Cavity #1



03  
 End Latches



04  
 Center Latch

Dimensions shown in inch (mm)  
 Specifications and dimensions subject to change

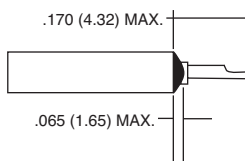
www.ittcannon.com



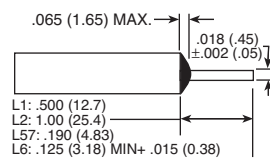
## Connector Weights

Contact (with std. 1/2" copper pigtails)			
			.040 gms.
	MTB	pin	.021 gms.
Insulator (per contact cavity)		socket	.006 gms.
	MTV	pin	.014 gms.
		socket	.004 gms.
Guide Post	Stainless Steel		
			.035 gms.
Latch	Male		.035 gms.
	Female		.074 gms.

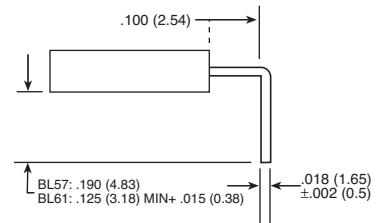
## Terminal Dimensions



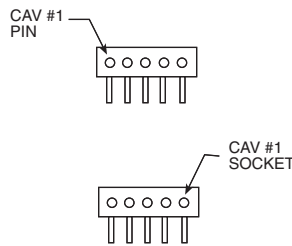
**Solder Cup**



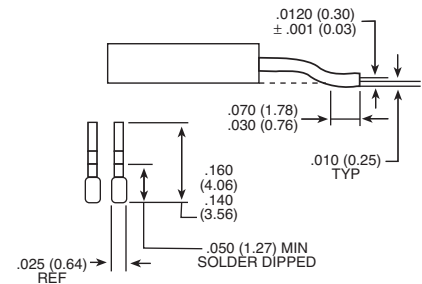
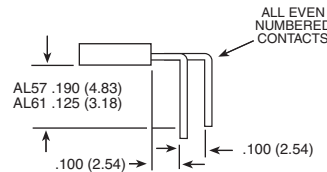
**Straight Terminals**



**Right Angle Terminals  
.050" Centers**

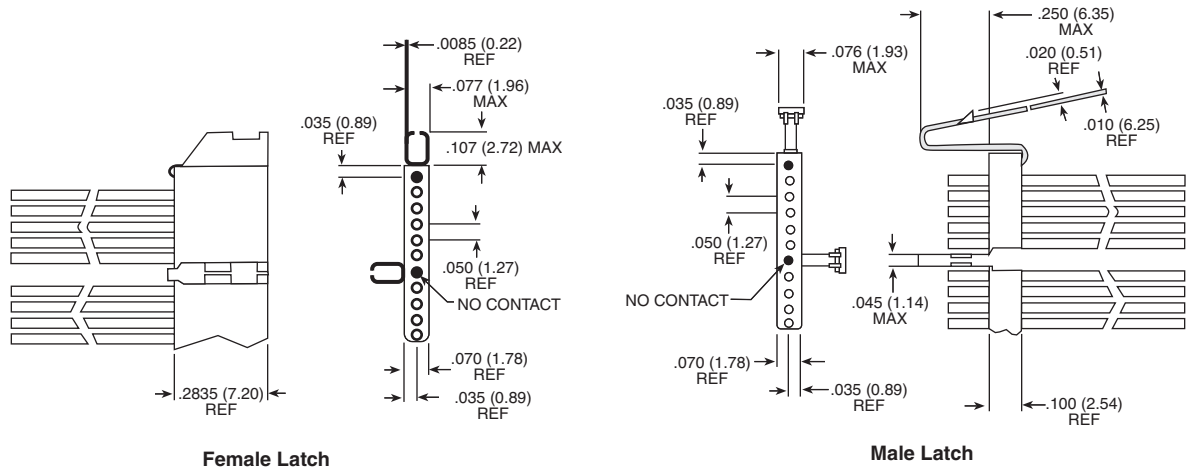


**Right Angle Terminals  
.100" Spacing Staggered**

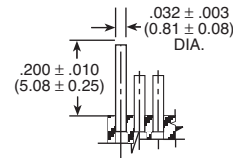


**Surface Mount Terminals**

## Latch Dimensions



## Guide Pin Dimensions



## Standard Wire Termination Codes

The following termination codes are listed for your information. For additional codes please refer to Appendix on page 79 and 81. **All wire lengths are minimum.**

### Harness Type - (H)

#26 AWG per MIL-W-16878 Type E; Teflon Stranded

Length	All Yellow	Color Coded
3 (76.2)	H020	H027
6 (152.4)	H019	H016
8 (203.2)	H026	H034
10 (254.0)	H029	H025
12 (304.8)	H028	H002
18 (457.2)	H001	H003
20 (508.0)	H033	H023
24 (609.6)	H009	H004
30 (762.0)	H010	H005
36 (914.4)	H011	H006
48 (1219.2)	H013	H048
72 (1828.5)	H017	H046
120 (3048.0)	H042	H041

### Solid Uninsulated Type - (L)

#25 AWG Gold Plated Copper

Termination Code	Length
L61	.125 (3.18)
L56	.150 (3.81)
L57	.190 (4.83)
L39	.250 (6.35)
L58	.375 (9.52)
L1	.500 (12.70)
L14	.750 (19.05)
L2	1.000 (25.40)
L7	1.500 (38.10)
L6	2.000 (50.80)
L16	2.500 (63.50)
L10	3.000 (76.20)

Dimensions shown in inch (mm)  
Specifications and dimensions subject to change

www.ittcannon.com



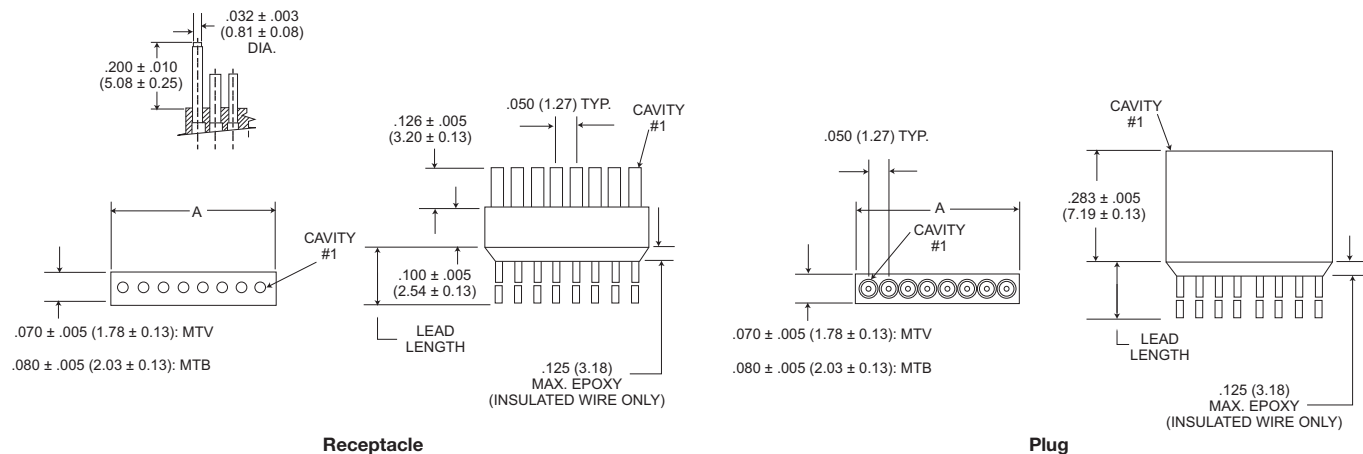
## Polarization



Modification code "-01" in the part number refers to guide posts located on both ends of the socket side of the 50-MIL STRIP connector and empty cavities on the pin side to accept the guide posts.

Although in many cases it is not necessary to polarize 50-MIL STRIP connectors, there are several ways to prevent cross plugging. One method is the use of guide posts that can be located in specified cavities to assure that the contacts will align when these post are positioned before mating.

## MTB1 and MTV1 - .050 (1.27) Contact Centers



Part Number by Size	A ±.015 (0.38)	Part Number by Size	A ±.015 (0.38)	Part Number by Size	A ±.015 (0.38)	Part Number by Size	A ±.015 (0.38)	Part Number by Size	A ±.015 (0.38)	Part Number by Size	A ±.015 (0.38)
MT*1-1**	.070 (1.78)	MT*1-21**	1.070 (27.18)	MT*1-41**	2.070 (52.58)	MT*1-61**	3.070 (77.98)	MT*1-81**	4.070 (103.38)	MT*1-101**	5.070 (128.78)
MT*1-2**	.120 (3.05)	MT*1-22**	1.120 (28.45)	MT*1-42**	2.120 (53.85)	MT*1-62**	3.120 (79.25)	MT*1-82**	4.120 (104.65)	MT*1-102**	5.120 (130.05)
MT*1-3**	.170 (4.32)	MT*1-23**	1.170 (29.72)	MT*1-43**	2.170 (55.12)	MT*1-63**	3.170 (80.52)	MT*1-83**	4.170 (105.92)	MT*1-103**	5.170 (131.32)
MT*1-4**	.220 (5.59)	MT*1-24**	1.220 (30.99)	MT*1-44**	2.220 (56.39)	MT*1-64**	3.220 (81.79)	MT*1-84**	4.220 (107.19)	MT*1-104**	5.220 (132.59)
MT*1-5**	.270 (6.85)	MT*1-25**	1.270 (32.36)	MT*1-45**	2.270 (57.66)	MT*1-65**	3.270 (83.06)	MT*1-85**	4.270 (108.46)	MT*1-105**	5.270 (133.86)
MT*1-6**	.320 (8.13)	MT*1-26**	1.320 (33.53)	MT*1-46**	2.320 (58.93)	MT*1-66**	3.320 (84.33)	MT*1-86**	4.320 (109.73)	MT*1-106**	5.320 (135.13)
MT*1-7**	.370 (9.40)	MT*1-27**	1.370 (34.80)	MT*1-47**	2.370 (60.20)	MT*1-67**	3.370 (85.60)	MT*1-87**	4.370 (111.00)	MT*1-107**	5.370 (136.40)
MT*1-8**	.420 (10.67)	MT*1-28**	1.420 (36.07)	MT*1-48**	2.420 (61.47)	MT*1-68**	3.420 (86.87)	MT*1-88**	4.420 (112.27)	MT*1-108**	5.420 (137.67)
MT*1-9**	.470 (11.94)	MT*1-29**	1.470 (37.34)	MT*1-49**	2.470 (62.74)	MT*1-69**	3.470 (88.14)	MT*1-89**	4.470 (113.54)	MT*1-109**	5.470 (138.94)
MT*1-10**	.520 (13.20)	MT*1-30**	1.520 (38.61)	MT*1-50**	2.520 (64.01)	MT*1-70**	3.520 (89.41)	MT*1-90**	4.520 (114.81)	MT*1-110**	5.520 (140.21)
MT*1-11**	.570 (14.48)	MT*1-31**	1.570 (39.88)	MT*1-51**	2.570 (65.28)	MT*1-71**	3.570 (90.68)	MT*1-91**	4.570 (116.08)	MT*1-111**	5.570 (141.48)
MT*1-12**	.620 (15.75)	MT*1-32**	1.620 (41.15)	MT*1-52**	2.620 (66.55)	MT*1-72**	3.620 (91.95)	MT*1-92**	4.620 (117.35)	MT*1-112**	5.620 (142.75)
MT*1-13**	.670 (17.02)	MT*1-33**	1.670 (42.42)	MT*1-53**	2.670 (67.82)	MT*1-73**	3.670 (93.22)	MT*1-93**	4.670 (118.62)	MT*1-113**	5.670 (144.02)
MT*1-14**	.720 (18.29)	MT*1-34**	1.720 (43.69)	MT*1-54**	2.720 (69.09)	MT*1-74**	3.720 (94.49)	MT*1-94**	4.720 (119.89)	MT*1-114**	5.720 (145.29)
MT*1-15**	.770 (19.56)	MT*1-35**	1.770 (44.96)	MT*1-55**	2.770 (70.36)	MT*1-75**	3.770 (95.76)	MT*1-95**	4.770 (121.16)	MT*1-115**	5.770 (146.56)
MT*1-16**	.820 (20.83)	MT*1-36**	1.820 (46.23)	MT*1-56**	2.820 (71.63)	MT*1-76**	3.820 (97.03)	MT*1-96**	4.820 (122.43)	MT*1-116**	5.820 (147.83)
MT*1-17**	.870 (22.10)	MT*1-37**	1.870 (47.50)	MT*1-57**	2.870 (72.90)	MT*1-77**	3.870 (98.30)	MT*1-97**	4.870 (123.70)	MT*1-117**	5.870 (149.10)
MT*1-18**	.920 (23.37)	MT*1-38**	1.920 (48.77)	MT*1-58**	2.920 (74.17)	MT*1-78**	3.920 (99.57)	MT*1-98**	4.920 (124.97)	MT*1-118**	5.920 (150.37)
MT*1-19**	.970 (24.64)	MT*1-39**	1.970 (50.04)	MT*1-59**	2.970 (75.44)	MT*1-79**	3.970 (100.84)	MT*1-99**	4.970 (126.24)	MT*1-119**	5.970 (151.64)
MT*1-20**	1.020 (25.91)	MT*1-40**	2.020 (51.31)	MT*1-60**	3.020 (76.71)	MT*1-80**	4.020 (102.11)	MT*1-100**	5.020 (127.50)	MT*1-120**	6.020 (152.91)

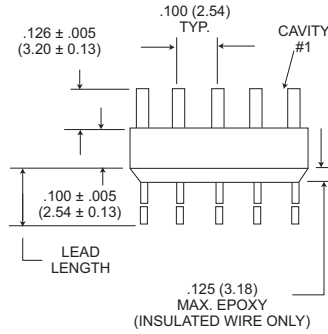
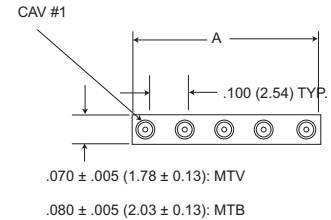
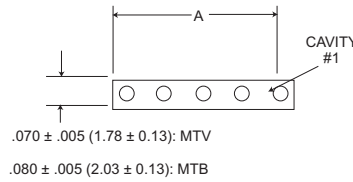
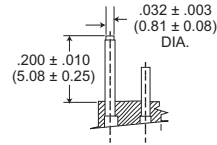
NOTE: MTB1 available in up to 120 contacts.



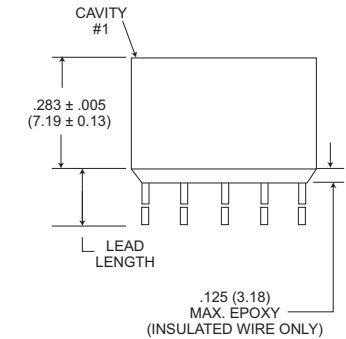
Dimensions shown in inch (mm)  
Specifications and dimensions subject to change

www.ittcannon.com

MTB2 and MTV2 - .100 (2.54) Contact Centers



Receptacle



Plug

Part Number by Size	A ±.015 (0.38)	Part Number by Size	A ±.015 (0.38)
MT*2-1**	.070 (1.78)	MT*2-31**	3.070 (77.98)
MT*2-2**	.170 (4.32)	MT*2-32**	3.170 (80.52)
MT*2-3**	.270 (6.86)	MT*2-33**	3.270 (83.06)
MT*2-4**	.370 (9.40)	MT*2-34**	3.370 (85.60)
MT*2-5**	.470 (11.94)	MT*2-35**	3.470 (88.14)
MT*2-6**	.570 (14.48)	MT*2-36**	3.570 (90.68)
MT*2-7**	.670 (17.02)	MT*2-37**	3.670 (93.22)
MT*2-8**	.770 (19.56)	MT*2-38**	3.770 (95.76)
MT*2-9**	.870 (22.10)	MT*2-39**	3.870 (98.30)
MT*2-10**	.970 (24.64)	MT*2-40**	3.970 (100.84)
MT*2-11**	1.070 (27.18)	MT*2-41**	4.070 (103.38)
MT*2-12**	1.170 (29.72)	MT*2-42**	4.170 (105.92)
MT*2-13**	1.270 (32.26)	MT*2-43**	4.270 (108.46)
MT*2-14**	1.370 (34.80)	MT*2-44**	4.370 (111.00)
MT*2-15**	1.470 (37.34)	MT*2-45**	4.470 (113.54)
MT*2-16**	1.570 (39.88)	MT*2-46**	4.570 (116.08)
MT*2-17**	1.670 (42.42)	MT*2-47**	4.670 (118.62)
MT*2-18**	1.770 (44.96)	MT*2-48**	4.770 (121.16)
MT*2-19**	1.870 (47.50)	MT*2-49**	4.870 (123.70)
MT*2-20**	1.970 (50.04)	MT*2-50**	4.970 (126.24)
MT*2-21**	2.070 (52.58)	MT*2-51**	5.070 (128.78)
MT*2-22**	2.170 (55.12)	MT*2-52**	5.170 (131.32)
MT*2-23**	2.270 (57.66)	MT*2-53**	5.270 (133.86)
MT*2-24**	2.370 (60.20)	MT*2-54**	5.370 (136.40)
MT*2-25**	2.470 (62.74)	MT*2-55**	5.470 (138.94)
MT*2-26**	2.570 (65.28)	MT*2-56**	5.570 (141.48)
MT*2-27**	2.670 (67.82)	MT*2-57**	5.670 (144.02)
MT*2-28**	2.770 (70.36)	MT*2-58**	5.770 (146.56)
MT*2-29**	2.870 (72.90)	MT*2-59**	5.870 (149.10)
MT*2-30**	2.970 (75.44)	MT*2-60**	5.970 (151.64)

Dimensions shown in inch (mm)  
Specifications and dimensions subject to change

www.ittcannon.com



# Micro Edgeboard - .050" Contact Spacing

# MEB



The Micro Edgeboard (MEB) connector series provides a combination of high density and high reliability for applications in airborne and space systems, computers and peripherals, and industrial /commercial control systems. This series incorporates the proven MICROPIN™/MICROSOCKET™ contact. This contact has an outstanding record of high reliability and millions of contacts are in use in various applications where electrical interconnects are used.

The MEB has machined aluminum shells for ruggedness, diallyl phthalate insulator for top electrical performance and a 36-position polarization key system to prevent cross plug-

ging. Contacts are on .050 (1.27) center spacings. A variety of termination types are available, including 90° or right angle pigtailed for multi-layered P.C. boards, "coke bottle" termination for double-sided P.C. boards. Harnessing capability is also available for both pin and socket sides.

The MEB, including the SBR 90° or right angle variation available for multi-layer boards, can be mounted on the female (daughter) side of double or single-sided P.C. boards. The mating male (mother) board side can have the terminations formed to meet the application demands.

Conforms to MIL-C-55302/120 thru 123. (not qualified)

## Specifications

### MATERIALS AND FINISHES

Shell:	6061-T6 Aluminum Alloy per QQ-A-200/8 or QQ-A-225/8, electroless nickel per SAE AMS-C-26074, Class 4, except .0010 to .0015 (0.03 to 0.04) thick or conversion coating per MIL-C-5541, Class 3, color gold.
Contact, Pin and Socket:	Copper Alloy, 50 microinch gold per ASTM B488, Type II, Code C, Class 1.25
Jackscrew/Jackpost:	303 stainless steel, passivated per QQ-P-35.
Insulator:	Glass-filled diallyl phthalate per MIL-M-14, Type SDG-F, color green Polyester per MIL-M-24519, Type GPT-30F, color black available for MEB-128 upon request.

### TERMINATION TYPES

Consult factory for stranded wire lead modifications codes.

### MECHANICAL FEATURES

Size or Length:	2 sizes
Coupling:	Friction/Jackscrew
Polarization:	Shells, polarizing keys (36 positions)
Contact Spacing Centers:	.050 (1.27)
Shell Styles:	Plug and receptacle

## How to Order



**RoHS COMPLIANCE**

**SERIES PREFIX**

**CONTACT SPACING**

**LAYOUT**

**CONTACT TYPE**

**TERMINATION MODIFICATIONS**

**LEAD LENGTH**

**OTHER MODIFICATIONS**

Not applicable for printed circuit board configurations shown on pages 55 & 56

R MEB 1 - 128 P \* \* \* \*

### SERIES PREFIX

MEB - Micro edgeboard, plug with twist pin contacts or recept. with microsocket contacts.

### CONTACT SPACING

1 - .050 (1.27) centers 128/184  
2 - .100 (2.54) centers 64/92  
(alternate contact holes)

### LAYOUT

64, 92, 128, 184

### CONTACT TYPE

P - Pin  
S - Socket

\* For other contact spacing accommodations consult customer service.

### TERMINATION MODIFICATIONS

L - Uninsulated solid wire  
H - Insulated stranded round harness wire  
S - Solder pots  
BR - PC board right angle, socket side only

### LEAD LENGTH

Consult factory for wire lead modification codes.

### OTHER MODIFICATIONS

Consult factory



Dimensions shown in inch (mm)  
Specifications and dimensions subject to change

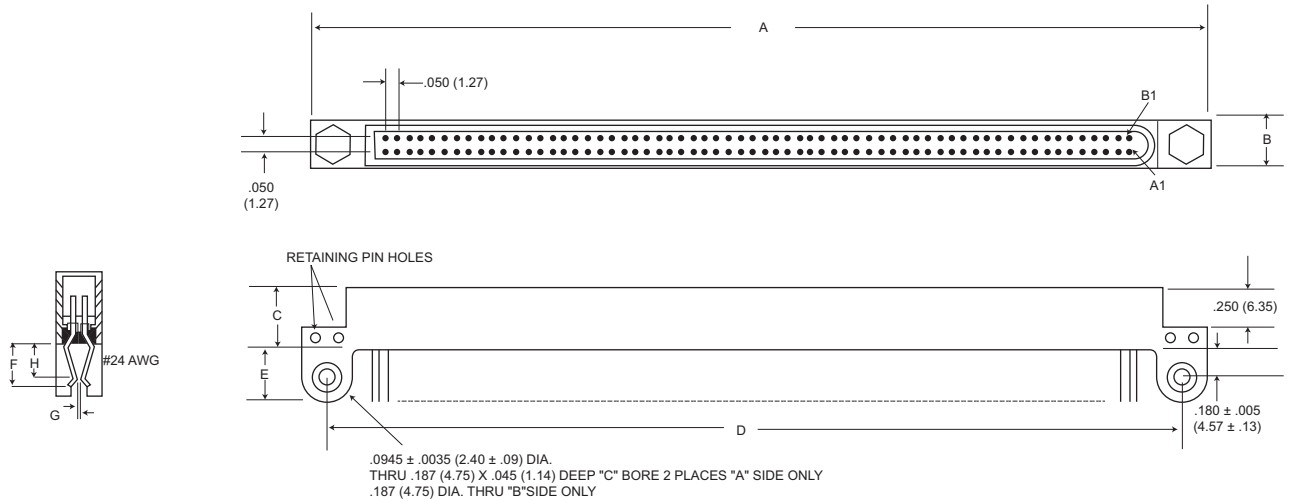
www.ittcannon.com

# Micro Edgeboard - .050" Contact Spacing

# MEB

## Plug (Mother Board)

MEB1-12BS

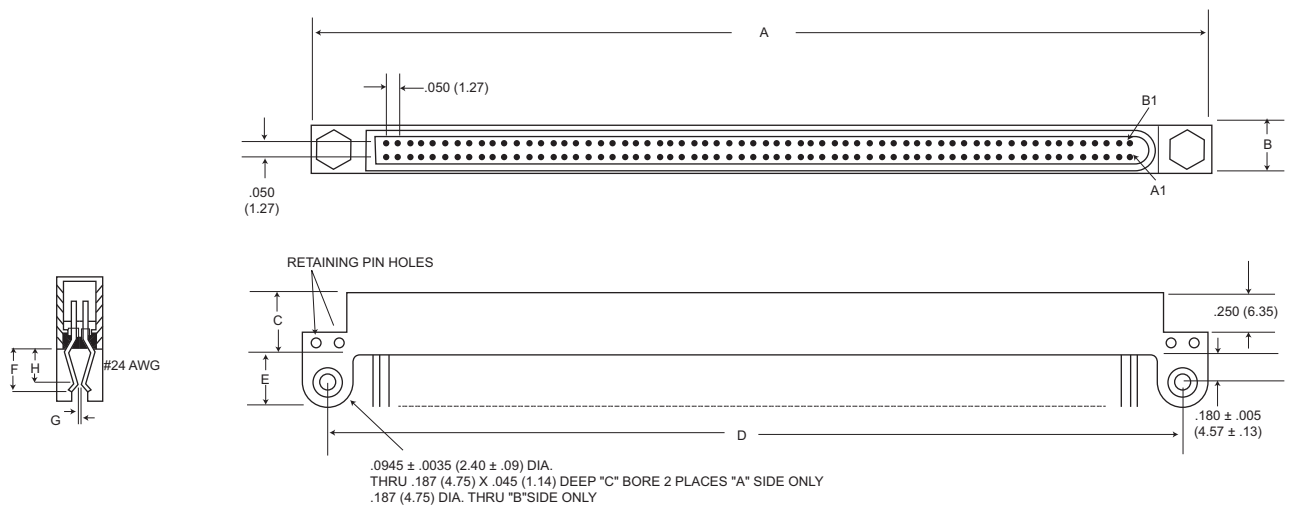


Part No.	Weight oz. (gm.) Max.	A ±.015 (0.38)	B ±.010 (0.25)	C ±.010 (0.25)	D ±.010 (0.25)	E ±.010 (0.25)	F Max.	G* Max.	H ±.020 (0.51)
128S	.5 (14.17)	3.950 (100.33)	.250 (6.35)	.400 (10.16)	3.700 (93.98)	.300 (7.62)	.280 (7.11)	.030 (0.76)	.200 (5.08)
128SBR	.5 (14.17)								

\*Will accept up to .093 (2.36) thick P.C. Board with shell modifications.

## Receptacle (Daughter Board)

MEB1-12BS



Part No.	Weight oz. (gm.) Max.	A ±.015 (0.38)	B ±.010 (0.25)	C ±.010 (0.25)	D ±.010 (0.25)	E ±.010 (0.25)	F Max.	G* Max.	H ±.020 (0.51)
128S	.5 (14.17)	3.950 (100.33)	.250 (6.35)	.400 (10.16)	3.700 (93.98)	.300 (7.62)	.280 (7.11)	.030 (0.76)	.200 (5.08)
128SBR	.5 (14.17)								

\*Will accept up to .093 (2.36) thick P.C. Board with shell modifications.

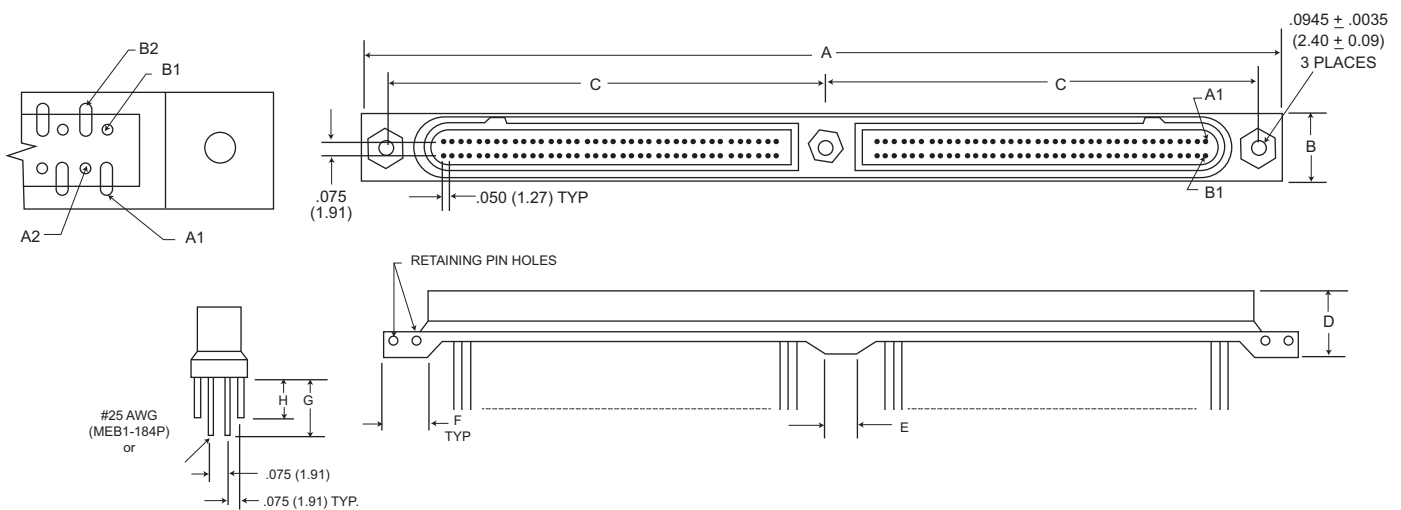
Dimensions shown in inch (mm)  
Specifications and dimensions subject to change

www.ittcannon.com



## Plug (Mother Board)

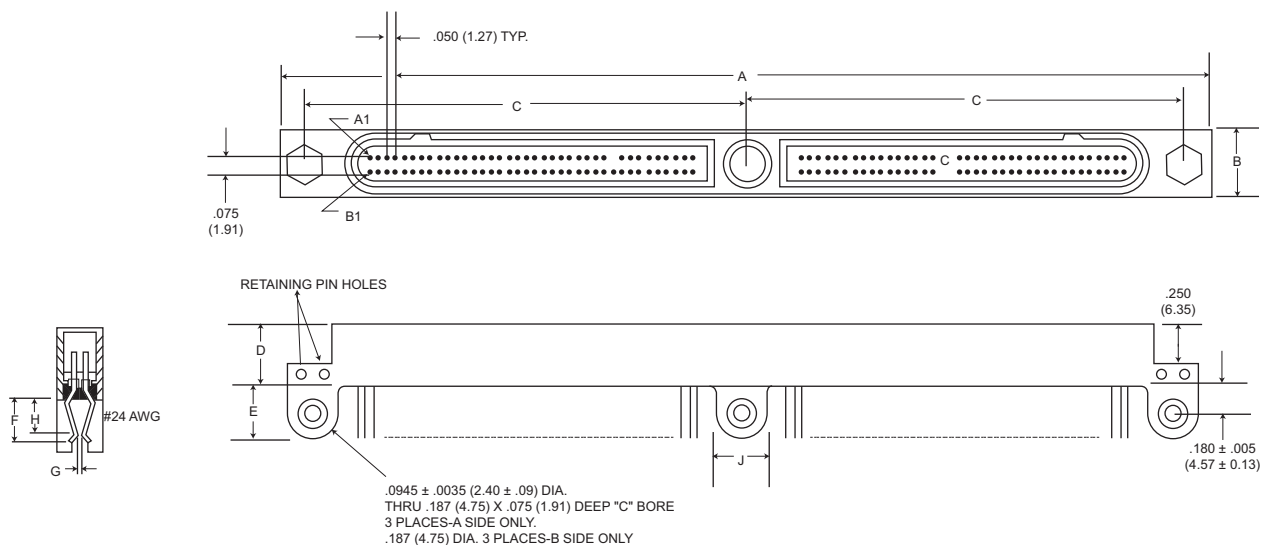
### MEB1-184P



Part No.	Weight oz. (gm.) Max.	A ±.015 (0.38)	B ±.010 (0.25)	C ±.005 (0.13)	D ±.010 (0.25)	E ±.010 (0.25)	F ±.010 (0.25)	G ±.025 (0.64)	H ±.025 (0.64)
184P	1.0 (28.35)	5.800 (147.32)	.343 (8.71)	2.775 (70.49)	.400 (10.16)	.250 (6.35)	.280 (7.11)	.350 (8.89)	.275 (6.99)

## Receptacle (Daughter Board)

### MEB1-184S



Part No.	Weight oz. (gm.) Max.	A ±.015 (0.38)	B ±.010 (0.25)	C ±.005 (0.13)	D ±.010 (0.25)	E ±.010 (0.25)	F Max.	G Max.	H ±.020 (0.51)	J ±.010 (0.25)
184S	1.0 (28.35)	5.800 (147.32)	.343 (8.71)	2.775 (70.49)	.400 (10.16)	.300 (7.62)	.280 (7.11)	.030 (0.76)	.200 (5.08)	.250 (6.35)
184SBR	1.0 (28.35)	5.800 (147.32)	.343 (8.71)	2.775 (70.49)	.400 (10.16)	.300 (7.62)	.280 (7.11)	.030 (0.76)	.200 (5.08)	.250 (6.35)

All round pigtail #25 AWG wire termination designs available for the MEB1-12B receptacle will apply on the MEB1-184 series also.

\*Will accept up to .093 (2.36) thick P.C. Board with shell modifications.

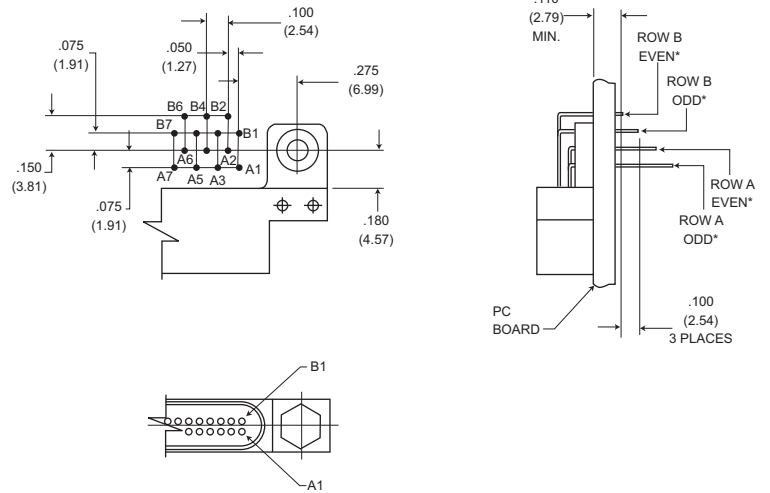


Dimensions shown in inch (mm)  
Specifications and dimensions subject to change

www.ittcannon.com

## PC Board Right Angle

### MEB1-128SBR

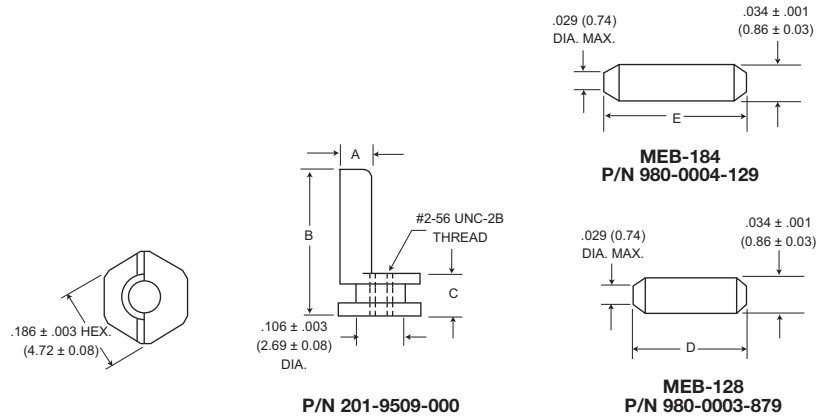


## Keying Accessory - Key and Retaining Pin

### Polarizing Hardware Kit

- MEB-128-P/N 320-9514-003
- MEB-184-P/N 320-9514-002

Contains 2 polarizing keys and 4 spiral pins.



A	B	C	D	E
± .003 (0.08)	± .005 (0.13)	± .003 (0.08)	± .010 (0.25)	± .010 (0.25)
.081 (2.06)	.325 (8.26)	.089 (2.26)	.250 (6.35)	.313 (7.95)

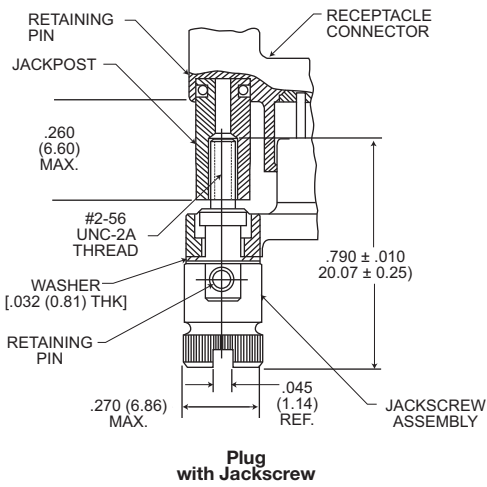
## JackscREW/ Jackpost Assembly (MEB 64 & 128 Sizes Only)

### Jackpost Kit

MEB plug or receptacle-P/N 320-9514-001  
 Contains 2 bushings and 4 spirals pins

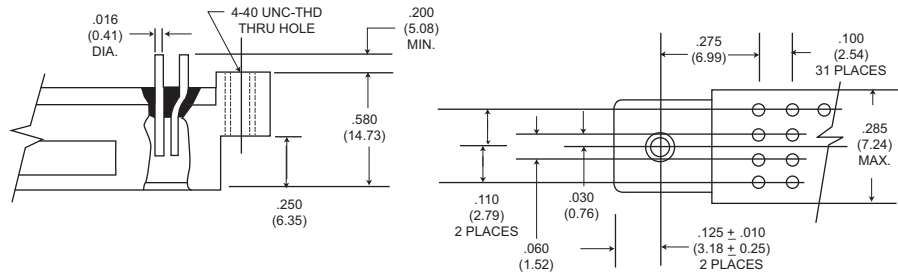
### JackscREW Kit

MEB plug-P/N 320-9521-001  
 MEB receptacle-P/N 320-9521-000  
 Contains 2 jackscrew assemblies



## Special Variations

### Alternative Receptacle Configuration



# The Centi Line - .075" Contact Spacing



The Cannon Centi connectors are especially suitable for commercial applications such as computers, instrumentation, communications and audio equipment. They are available in D subminiature size metal shell rectangular, plastic shell rectangular and strip configurations.

All Centi connectors use the reliable twist pin contact design in a 5 amp version terminated on .075 (1.91) and .100 (2.54) centers. The Centi contact is crimp removable, connectors are available for customer assembly. Standard crimp and assembly tools are available.

The twist pin contact is recessed within the insulator housing while the rugged cylindrical socket is exposed. When the connector halves are mated, the chamfered sockets guide the pins into positive alignment. The Centipin™ contact, now under compression, forms a multi-point contact with the Centisocket™ to provide a high degree of reliability.

## Standard Data

- Contact rating: 5 amps max, except BR Series (2 amps max.)
- Minimum contact centers: 0.075 (1.91).
- Wire sizes: #22 thru #26 AWG, stranded or solid.
- Contact termination: Multiple indent crimp.
- Contact retention: Crimp snap-in/removable.
- Contact materials and finish: Copper alloy, gold-plated per ASTM B488, Type II, Code C, Class 1.25.
- Mating/unmating force: 12 oz. per contact, max.

## Performance Data

Test	Method	Criteria of Acceptance
Dielectric Withstanding Voltage	Method 301: 1,000 VAC at sea level 300 VAC at 70,000' altitude	No breakdown No breakdown
Insulation Resistance	Method 302, Condition A	5,000 megohms minimum
Thermal Shock	Method 107, Condition A +55°C to +85°C	No physical damage
Physical Shock	Method 213, Condition I: 100 G's, 3 axes, 6 millisecond duration sawtooth pulse	No physical damage No loss of continuity > 1/μsec
Vibration	Method 204, Condition B: 15 G's, 10-2,000 Hz, 12 hours	No physical damage No loss of continuity > 1μsec
Durability	500 cycles of mating and unmating, 500 CPH max.	No mechanical or electrical defects
Moisture Resistance	Method 106, Omit 7a and 7b	Insulation resistance > 100 megohms
Salt Spray	Method 101, Condition B: 48 hours	Shall be capable of mating and unmating and meet contact resistance requirements
Contact Resistance	Method 307: At 5 amps	9 milliohms maximum
Contact Retention	-	4 lb. minimum axial load (after 10 insertion extraction cycles)

Dimensions shown in inch (mm)  
Specifications and dimensions subject to change

www.ittcannon.com



# Double Density D - .075" Contact Spacing

# 2D

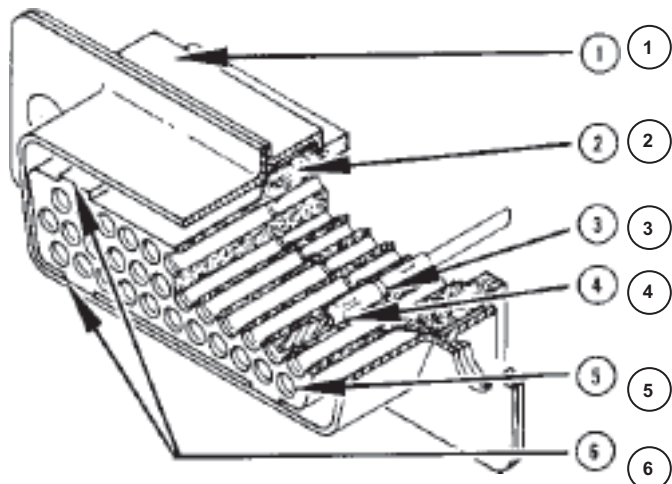
The Double Density D is a rectangular connector in the popular D Subminiature shell configuration featuring double the contact density in the same insert area. The Double Density D connector can thus accommodate up to 100 contacts instead of 50.

This double contact density is achieved by using field-proven, highly reliable Centipin™/Centisocket™ contacts on .075 (1.91) centers, in the positive contact alignment design. In this design contact

positions are reversed; the flexible Centipin™ contacts are recessed in the insulator and the more rugged Centisocket™ contacts are exposed. This reversal of positions, and the chamfered-entry of the sockets, assures positive mating even under severe misalignment conditions. The contacts are retained in the monobloc insulator by a resilient internal shoulder that snaps into a locking groove in the contact. The chamfered front of the contact will not damage the internal shoulder in the insulator.

Contacts are crimp removable type.

The Double Density D connector is available in the five popular shell and insert sizes accommodating up to 100 contacts. These connectors mate exclusively with other Double Density D connectors. A wide range of accessories can be used, including junction shells, potting cups, switching shells, guide pin plates, and dust caps.



- 1. STANDARD D HARDWARE-**  
Including full range of D-Subminiature accessories
- 2. ONE PIECE MONOBLOCK INSULATOR-**  
glass-filled nylon material
- 3. CONTACT RETENTION-**  
thermoplastic internal shoulder snaps into a locking groove in the contact.  
Retention Force: 8 lbs. min. initially, 4 lbs. min. after 10 cycles.
- 4. TWIST PIN CONTACTS-**  
seven outer wiping surfaces assure electrical continuity even under severe shock and vibration
- 5. POSITIVE CONTACT ALIGNMENT-**  
flexible pin is recessed in insulator cavity and rugged socket is exposed
- 6. GUIDE-IN KEYS AND KEYWAYS-**  
assure alignment during mating and prevent scooping

## Specifications

### WEIGHT

Part Number by shell size	Weight (in gr.)		Weight (in oz.)	
	Less With Contacts	Less With Contacts	Less With Contacts	Less With Contacts
2DE19P	4.05	5.02	.142	.177
2DE19S	3.75	5.17	.133	.182
2DA31P	5.20	6.78	.183	.239
2DA31S	4.90	7.22	.173	.255
2DB52P	8.75	11.40	.308	.402
2DB52S	7.15	11.05	.252	.390
2DC79P	11.70	15.73	.413	.555
2DC79S	9.70	15.62	.342	.551
2DD100P	12.85	17.95	.453	.633
2DD100S	10.95	18.45	.386	.651

### MATERIALS AND FINISHES

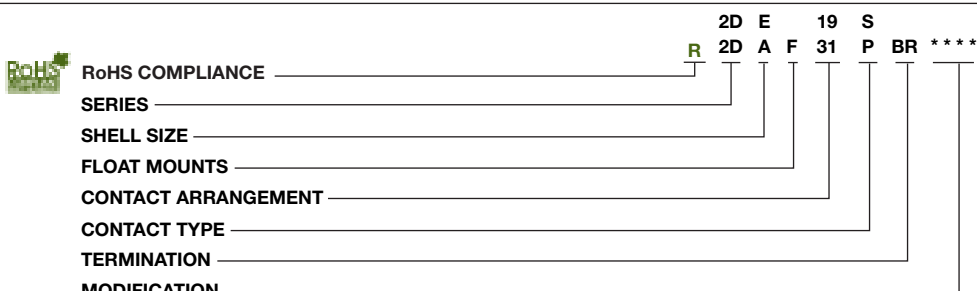
*Shell	- Steel, cadmium plated with yellow chromate supplementary coating
Mounting Hardware and Float Mounts	- Stainless steel
Insulator	- Glass-filled nylon
Contacts	- Copper alloy, gold plate
Alternate finish,	- A106 Gold over brass
Modification Code	A156 Gold over brass A197 Tin/Lead over steel

\*Brass non-magnetic also available

### MECHANICAL FEATURES

Sizes	- Five shell sizes: E, A, B, C, and D
Coupling	- Friction or jackscrew
Polarization	- Keystone-shaped shells
Contact Spacing	- .075 (1.91)
Contact Termination	- Crimp snap-in

## How to Order



### SERIES

2D - Double Density D

### SHELL SIZE

E, A, B, C and D

### FLOAT MOUNTS

Omit if not required

### CONTACT ARRANGEMENT

19, 31, 52, 79 and 100

### CONTACT TYPE\*

P - Pin  
S - Socket

### TERMINATION

BR - 90° right angle PCB mounting  
(For BR Series use "P" to designate jackpost)

### MODIFICATION

F171 - Jackpost assembly  
F172 - Standard jackscrew  
F173 - Low profile jackscrew

For other modifications consult factory  
Dimensions shown in inch (mm)

\* Accommodates AWG #26 thru #22

Specifications and dimensions subject to change

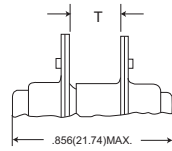
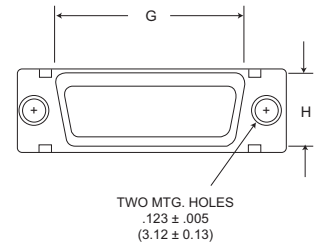
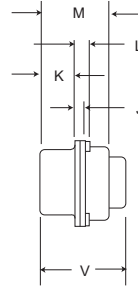
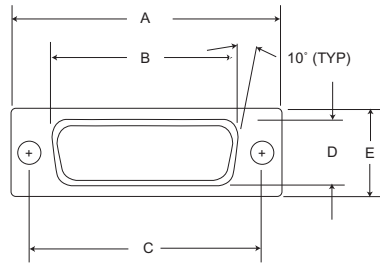


www.ittcannon.com

# Double Density D - .075" Contact Spacing

2D

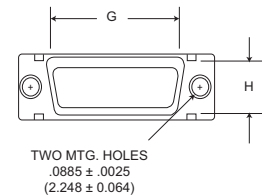
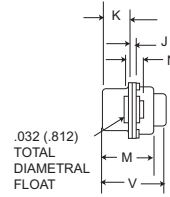
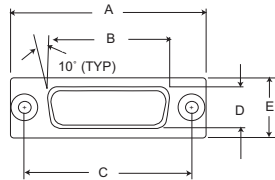
## Standard Shell



Part Number by Shell Size	T + .020 (0.51) - .000 (0.00)
2DE19P	.250 (6.35)
2DE19S	.250 (6.35)
2DA31P	.250 (6.35)
2DA31S	.250 (6.35)
2DB52P	.236 (5.99)

Part Number by Shell Size	T + .020 (0.51) - .000 (0.00)
2DB52S	.236 (5.99)
2DC79P	.236 (5.99)
2DC79S	.236 (5.99)
2DD100P	.236 (5.99)
2DD100S	.236 (5.99)

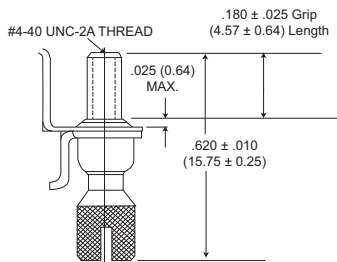
## Float Mount



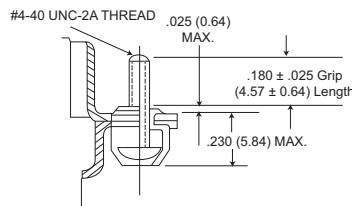
Part Number by Shell Size	A	B	C	D	E	G	H	J	K	L	M	N	V
	± .015 (0.38)	± .010 (0.25)	± .010 (0.25)	± .010 (0.25)	± .015 (0.38)	± .010 (0.25)	± .010 (0.25)	± .010 (0.25)	± .010 (0.25)	± .010 (0.25)	± .010 (0.25)	± .010 (0.25)	Max.
2DE19P	1.213 (30.81)	.697 (17.70)	.984 (24.99)	.360 (9.14)	.494 (12.55)	.759 (19.28)	.422 (10.72)	.036 (.914)	.236 (5.99)	.055 (1.40)	.422 (10.72)	.120 (3.05)	.555 (14.10)
2DE19S	1.213 (30.81)	.640 (16.26)	.984 (24.99)	.308 (7.82)	.494 (12.55)	.759 (19.28)	.422 (10.72)	.032 (.812)	.243 (6.17)	.047 (1.19)	.429 (10.90)	.120 (3.05)	.555 (14.10)
2DA31P	1.541 (39.14)	1.025 (26.03)	1.312 (33.32)	.360 (9.14)	.494 (12.55)	1.083 (27.51)	.422 (10.72)	.036 (.914)	.236 (5.99)	.055 (1.40)	.422 (10.72)	.120 (3.05)	.555 (14.10)
2DA31S	1.541 (39.14)	.968 (24.58)	1.312 (33.32)	.308 (7.82)	.494 (12.55)	1.083 (27.51)	.422 (10.72)	.032 (.812)	.243 (6.17)	.047 (1.19)	.429 (10.90)	.120 (3.05)	.555 (14.10)
2DB52P	2.088 (53.03)	1.583 (40.21)	1.852 (47.04)	.378 (9.60)	.494 (12.55)	1.625 (41.27)	.422 (10.72)	.036 (.914)	.231 (5.87)	.055 (1.40)	.426 (10.82)	.129 (3.28)	.555 (14.10)
2DB52S	2.088 (53.03)	1.508 (38.30)	1.852 (47.04)	.308 (7.82)	.494 (12.55)	1.625 (41.27)	.422 (10.72)	.032 (.812)	.243 (6.17)	.047 (1.19)	.429 (10.90)	.120 (3.05)	.555 (14.10)
2DC79P	2.729 (69.31)	2.231 (56.67)	2.500 (63.50)	.378 (9.60)	.494 (12.55)	2.272 (57.71)	.422 (10.72)	.036 (.914)	.231 (5.87)	.055 (1.40)	.426 (10.82)	.129 (3.28)	.555 (14.10)
2DC79S	2.729 (69.31)	2.156 (54.76)	2.500 (63.50)	.308 (7.82)	.494 (12.55)	2.272 (57.71)	.422 (10.72)	.032 (.812)	.243 (6.17)	.047 (1.19)	.429 (10.90)	.120 (3.05)	.555 (14.10)
2DD100P	2.635 (66.92)	2.127 (54.02)	2.406 (61.11)	.484 (12.29)	.605 (15.37)	2.178 (55.32)	.534 (13.56)	.036 (.914)	.231 (5.87)	.055 (1.40)	.426 (10.82)	.129 (3.28)	.555 (14.10)
2DD100S	2.635 (66.92)	2.062 (52.37)	2.406 (61.11)	.420 (10.67)	.605 (15.37)	2.178 (55.32)	.534 (13.56)	.032 (.812)	.243 (6.17)	.047 (1.19)	.429 (10.90)	.120 (3.05)	.555 (14.10)

For shell with float mounts, add letter F after shell size, e.g., 2DEF19P.

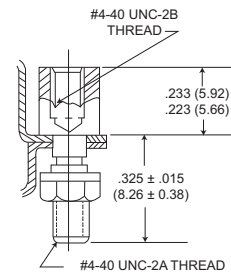
## JackscREW/Jackpost Assembly



Standard (F172) Jackscrew  
(factory installed)



Low Profile (F173) Jackscrew  
(factory installed)



Jackpost (F171)  
Front Panel Connector Mounting Only

Dimensions shown in inch (mm)  
Specifications and dimensions subject to change

www.ittcannon.com

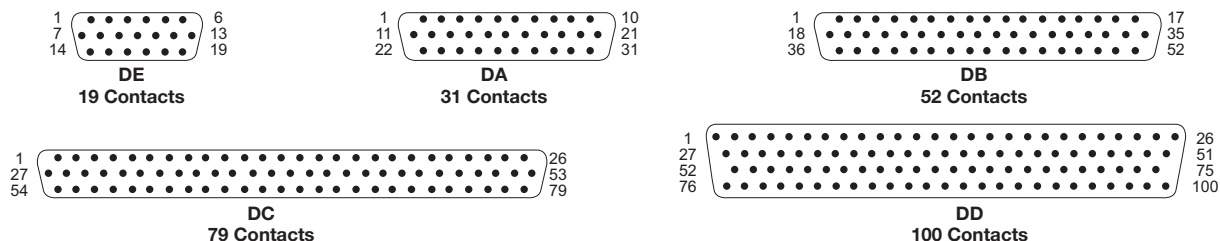


# Double Density D - .075" Contact Spacing

2D

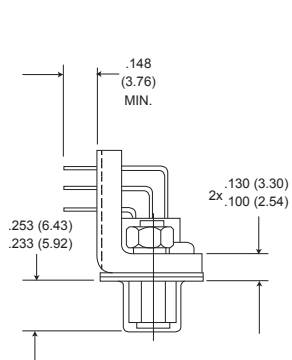
## Contact Arrangements

All views are pin front face. Use reverse order for socket side.



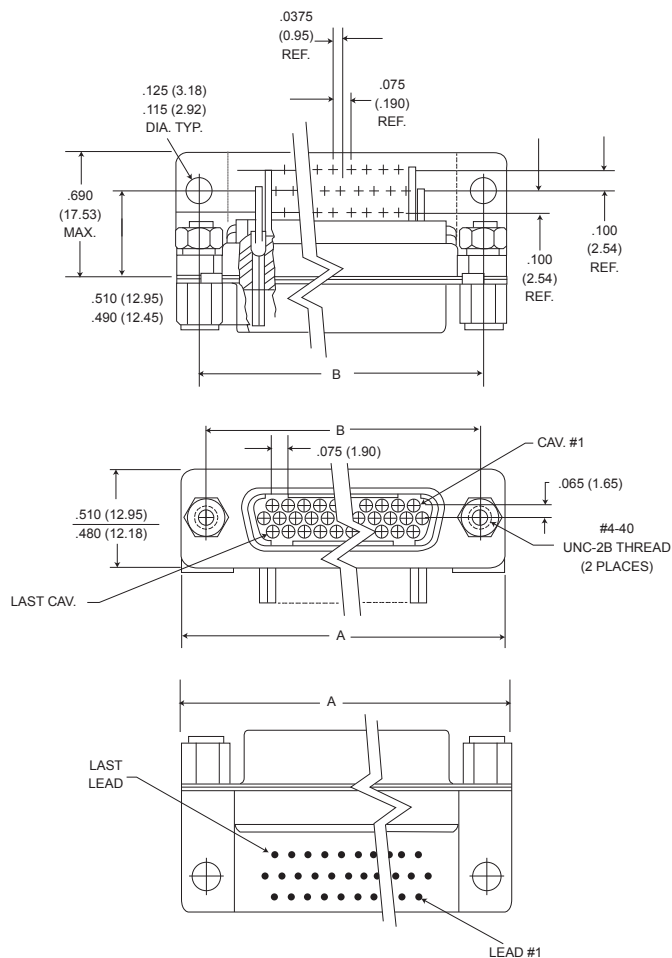
Cavity identification numbers are shown for reference only and do not appear on insulator front face. However they do appear on rear of insulator.

## 90° PCB Mounting - 3 Row



**PCB Termination Leads**  
(all contact arrangements)  
.024 (6.10) to .028 (7.11).

**Suggested finished PC hole**  
Size .033 (8.38) + .003 (0.08)



Part Number by Shell Size	A ± .015 (0.38)	B ± .010 (0.25)	C Max.
2DE19SBRP	1.215 (30.86)	.984 (24.99)	.690 (17.53)
2DA31SBRP	1.540 (39.12)	1.312 (33.32)	.690 (17.53)
2DB52SBRP	2.090 (53.09)	1.852 (47.04)	.690 (17.53)
2DC79SBRP	2.730 (69.34)	2.500 (63.50)	.690 (17.53)



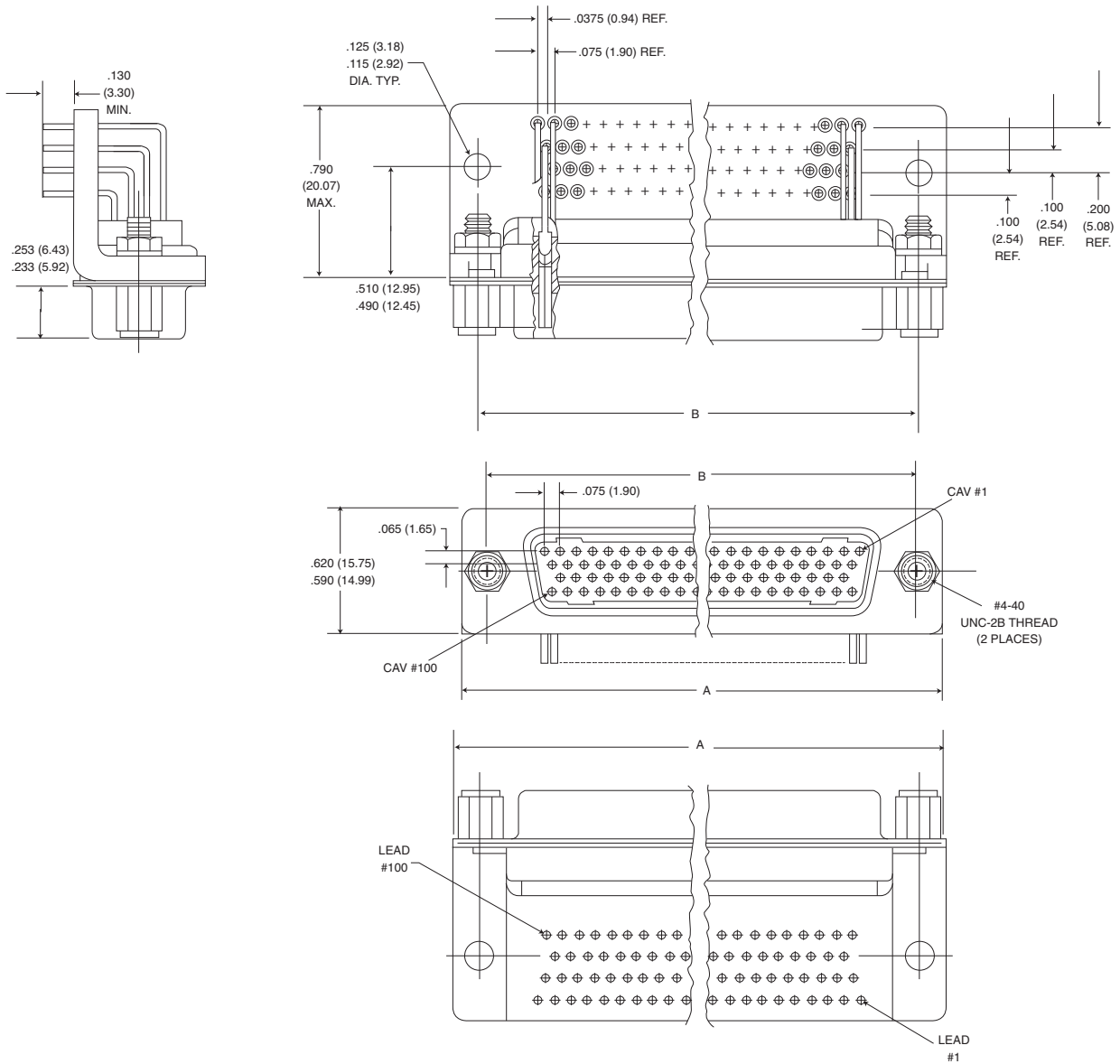
Dimensions shown in inch (mm)  
Specifications and dimensions subject to change

www.ittcannon.com

# Double Density D - .075" Contact Spacing

2D

90° PCB Mounting - 4 Row



Part Number by Shell Size	A ± .015 (0.38)	B ± .010 (0.25)	C Max.
2DD100SBRP	2.635 (66.93)	2.406 (61.11)	.790 (20.07)

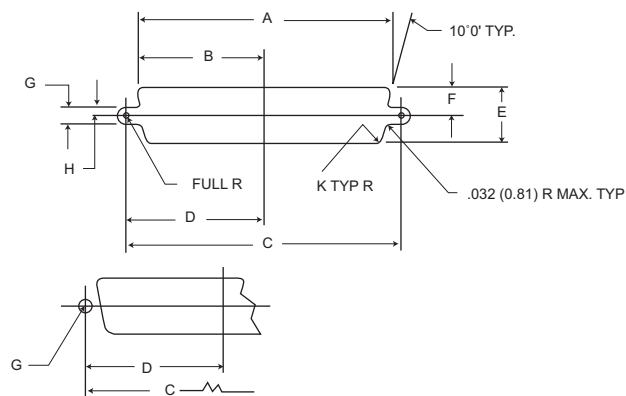
Contact Arrangements - Page 62

Dimensions shown in inch (mm)  
Specifications and dimensions subject to change

www.ittcannon.com



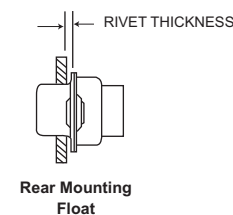
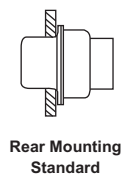
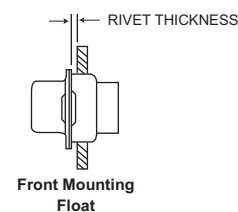
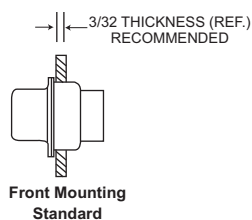
## Panel Cutouts



Conn.	Mtg. Method	A ± .005 (0.13)	B ± .005 (0.13)	C ± .005 (0.13)	D ± .005 (0.13)	E ± .005 (0.13)	F ± .005 (0.13)	G ± .002 (0.05)	H ± .002 (0.05)	K ± .002 (0.05)
<b>2DE</b>	Front	.874 (22.20)	.437 (11.10)	.984 (24.99)	.492 (12.50)	.513 (13.03)	.257 (6.53)	.120 (3.05)	.060 (1.52)	.083 (2.11)
	Rear	.806 (20.47)	.403 (10.24)	.984 (24.99)	.492 (12.50)	.449 (11.40)	.225 (5.71)	.120 (3.05)	.060 (1.52)	.132 (3.35)
<b>2DA</b>	Front	1.202 (30.53)	.601 (15.26)	1.312 (33.32)	.656 (16.66)	.513 (13.03)	.257 (6.53)	.120 (3.05)	.060 (1.52)	.083 (2.11)
	Rear	1.134 (28.80)	.567 (14.40)	1.312 (33.32)	.656 (16.66)	.449 (11.40)	.225 (5.71)	.120 (3.05)	.060 (1.52)	.132 (3.35)
<b>2DB</b>	Front	1.743 (44.27)	.872 (22.15)	1.852 (47.04)	.926 (23.52)	.513 (13.03)	.257 (6.53)	.120 (3.05)	.060 (1.52)	.083 (2.11)
	Rear	1.674 (42.52)	.837 (21.26)	1.852 (47.04)	.926 (23.52)	.449 (11.40)	.225 (5.71)	.120 (3.05)	.060 (1.52)	.132 (3.35)
<b>2DC</b>	Front	2.391 (60.73)	1.196 (30.38)	2.500 (63.50)	1.250 (31.75)	.513 (13.03)	.257 (6.53)	.120 (3.05)	.060 (1.52)	.083 (2.11)
	Rear	2.326 (59.08)	1.163 (29.54)	2.500 (63.50)	1.250 (31.75)	.449 (11.40)	.225 (5.71)	.120 (3.05)	.060 (1.52)	.132 (3.35)
<b>2DD</b>	Front	2.297 (58.34)	1.149 (29.18)	2.406 (61.11)	1.203 (30.56)	.623 (15.82)	.312 (7.92)	.120 (3.05)	.060 (1.52)	.083 (2.11)
	Rear	2.218 (56.34)	1.109 (28.17)	2.406 (61.11)	1.203 (30.56)	.555 (14.10)	.278 (7.06)	.120 (3.05)	.060 (1.52)	.132 (3.35)

For contact part numbers, termination tooling and assembly see pages 67-69.

## Panel Mounting



# Centi-D Loc-.075" Contact Spacing

# CDL

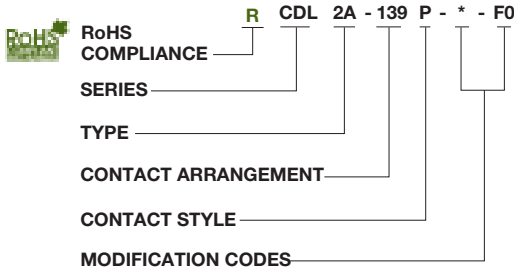


A subminiature all plastic high density "D" rectangular connector. The CDL is a general purpose connector with a peripheral o-ring and wire sealing gasket. Connector utilizes rear insertion, front release, crimp snap-in size 22, centi-loc contacts installable by the customer or, if preferred, by the factory.

### MATERIAL

Insulator:	Black Nylon
Dielectric Gasket:	Polychloroprene
Contact:	Copper Alloy, Gold Plated
Seal Ring:	Silicone

## How to Order



### SERIES

Centi-D Loc Series

### TYPE

- 2 - No lock (mtg. holes)
- 2A - No lock type with rear gasket

### CONTACT ARRANGEMENT

139  
(Consult customer service for other sizes)

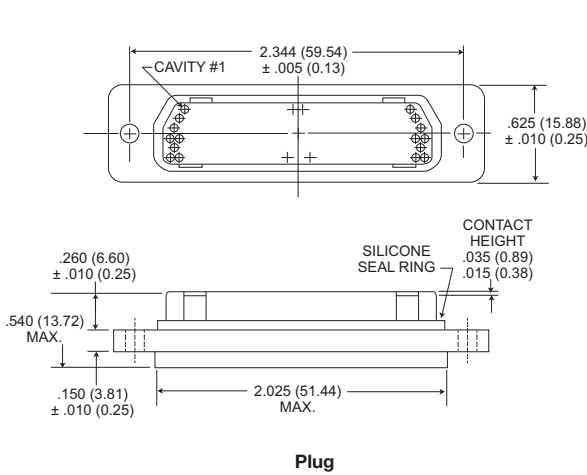
### CONTACT STYLE

- P - Centi-loc pin
- S - Centi-loc socket

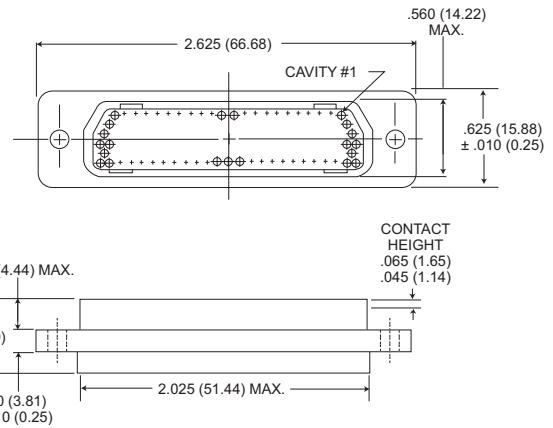
### MODIFICATION CODES

F0 - Less contacts

## Plug

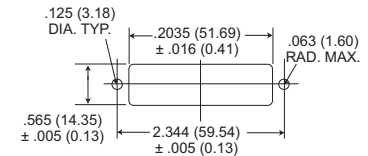


Plug



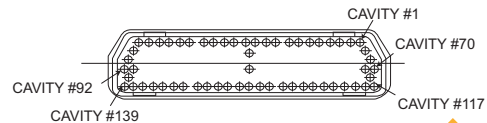
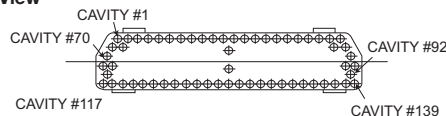
Receptacle

## Recommended Panel Cutouts



## Contact Arrangements

### Engaging Face View



Dimensions shown in inch (mm)  
Specifications and dimensions subject to change

www.ittcannon.com

Receptacle



# Strip Connectors - .100"/.075" Contact Spacing

# CTA



CENTI-LOC connectors are low-cost nylon strip connectors designed for commercial applications such as instrumentation, communications, and medical equipment. They are available in continuous strip form up to a maximum length of 6 inches (152.40mm), accommodating from 1 to 60 rear insertion, front release, crimp snap-in size 22 CENTIPIN™/CENTISOCKET™ contacts. These contacts utilize a proven positive contact alignment

design, giving additional contact strength and positive contact alignment during mating.

These connectors can be ordered in kit or bulk form. The kit comprises all the parts necessary to assemble one complete 6-inch (152.40) strip connector with 60 contacts on .100 (2.54) centers or a 4-inch (101.60mm) strip with 53 contacts on .075 (1.91) centers. If more than one connector is required, the parts can be ordered in bulk and assembled as desired.

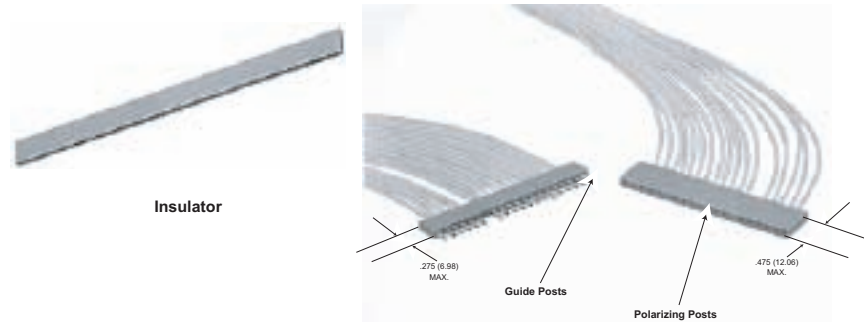
## Components and Accessories

The CENTI-LOC strip connector can be ordered in kit or bulk form. The kit includes mating insulators with a full complement of contacts and two guide posts. If more than one connector is required, the parts can be ordered in bulk and assembled as desired.

### Kit Form

Kits include mating insulators with full complement of contacts and two guide posts.

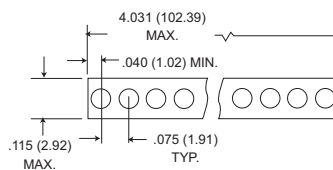
Part Number	Contact Center spacing
CTA3-KIT	.075 (1.91)
CTA4-KIT	.100 (2.54)
CTA3-CTA4-KIT	.075 (1.91) & .100 (2.54)



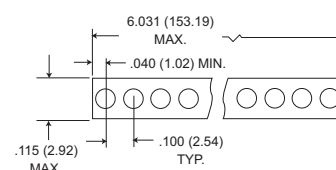
The guide posts and polarizing posts are inserted in the same manner as the contacts. The guide posts are inserted into the socket insulator and the polarizing posts are inserted into the pin insulator. The corresponding contact in the mating insulator must be removed for each. See assembly instructions.

	Part Number	Contact Center Spacing	Type	Material
Insulator	CTA3-IP-53	.075 (1.91)	Pin	Nylon
	CTA3-IS-53	.075 (1.91)	Socket	Nylon
	CTA4-IP-60	.100 (2.54)	Pin	Nylon
	CTA4-IS-60	.100 (2.54)	Socket	Nylon
Guide Post	CTA-GP	P/N 230-9507-000		Passivated Stainless Steel
Polarizing Post	CTA-PP	P/N 230-9506-000		Passivated Stainless Steel

## Dimensional Data



CTA3-.075(1.91) Centers



CTA4-.100(2.54) Centers

### Weights

Part Number	No. of Contacts	Contacts Type	Avy. Weight oz.	± 5% gm.
CTA3	53	pin	.185	5.25
		socket	.203	5.75
CTA4	60	pin	.230	6.30
		socket	.241	6.90



Dimensions shown in inch (mm)  
Specifications and dimensions subject to change

www.ittcannon.com

## Contacts




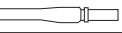




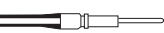










A resilient internal shoulder retains the contacts in the insulator housing. The front of the contact is chamfered to prevent damage to the internal shoulder as the contact is pushed into position.

### P.C. Tail Contacts

Subtract .064 (1.63) ± .010 (.25) from pigtail length when used in 2D pin insulator for potting well of connector assembly.

Subtract .081 (2.08) ± .010 (.25) from pigtail length when used in 2D socket insulator for potting well of connector assembly.

### Contact Part Number

Part Number		Type	Pin	Socket
Pin	Socket			
031-9540-000	030-9542-001	Standard 30µin. plating		
031-9540-004	030-9542-002	50µ in. plating		
031-9540-005	030-9542-004	With inspection hole; 50µ in. plating		
N/A	030-9542-011	P.C. tail .026 dia. x .083 lg. Soc.		
*031-9540-013	030-9542-012	P.C. tail .020 dia. x .183 lg. Soc. .183 lg. Pin		
031-9540-016	030-9542-014	Long crimp barrel **		
031-9540-022 ***	030-9556-000 ***	Small crimp bore For AWG #32 & 30		
031-9540-007	030-9542-022	Small crimp bore For AWG #28 & 30		
*031-9540-015	030-9542-015	P.C. tail .020 dia. x .232 lg. Soc. .255 lg. Pin		
*031-9540-019	030-9542-016	P.C. tail .018 dia. x .444 lg. Soc. .445 lg. Pin  50µ in. plating		

NOTE: Plating, except as noted, is 30 micro-inch gold.

\* Consult factory for any tail size or plating requirements.

\*\* Special crimp locator required. Part number: 995-0001-714. (L3198-CL-PSL)

\*\*\* Use special insertion tip (323-9510-016 &-017).

## 2D and Centi-Loc Crimp and Assembly Tools



M22520/2-01



CIET-CTA  
Handle



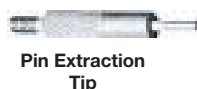
Insertion Tips



CTA-AB  
Assembly Holding  
Block  
Part Number: 328-9508-000



Socket Extraction  
Tip



Pin Extraction  
Tip

	Tool	Locators	
		Pin	Socket
Description	M22520/2-01	L3198-CLP	L3198-CLS
Part Number	995-0001-584	995-0001-338	995-0001-353

### Insertion Tools For Standard Contact

AWG Size*	Kit Part Number (handle and tip)	Tip Part Number**	Handle Part Number**
22	CIT-PS-CTA-22	323-9510-001	204-9500-000
24	CIT-PS-CTA-24	323-9510-002	204-9500-000
26	CIT-PS-CTA-26	323-9510-003	204-9500-000
28	CIT-PS-CTA-28	323-9510-004	204-9500-000
30/P.C. Tail	CIT-PS-CTA-30	323-9510-005	204-9500-000

\* Based on wire size per MIL-W-16878 with Type E insulation, use smaller tool for wire with thin insulation, larger tool for wire having thick insulation.

\*\* The 5 insertion tips (part numbers 323-9510-001 thru - 005). plus handle, and the pin and socket extraction tips may be ordered as a SINGLE KIT by specifying the part number CIET-CTA-2. [Part number: 070143-0002].

### Insertion Tools For Long Crimp barrel Contacts

AWG Size*	Tip Part Number *** Pin Contact	Tip Part Number *** Socket Contact	Handle Part Number***
22	323-9510-008	323-9510-012	204-9500-000
24	323-9510-009	323-9510-013	204-9500-000
26	323-9510-010	323-9510-014	204-9500-000

\*\*\* To order the SINGLE KIT for the long crimp barrel contact (tip part numbers 323-9510-008 thru -014, handle and pin and socket extraction tips) please specify CIET-CTA-3.

### Extraction Tools

Contact	Description	Kit Part Number (handle and tip)	Tip Part Number	Handle Part Number
CENTIPIN	CET-P-CTA-2	070112-0002	324-9502-000	204-9500-000
CENTISOCKET	CET-S-CTA-1	070113-0001	324-9501-000	204-9500-000

Dimensions shown in inch (mm)

Specifications and dimensions subject to change

www.ittcannon.com



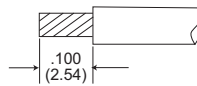
## 2D/CTA CENTI-LOC™ Connectors Assembly Instructions

The Double Density D/CTA CENTI-LOC Connectors are highly reliable and simple connectors to use. There are a few helpful suggestions that will assure complete satisfaction when followed:

1. The following instructions should be followed.
2. The proper crimp tool and locator (if required) must be used. These tools have been designed for use with this product. Substitutions of crimping equipment may result in connector failure at the assembly operation.
3. After crimping a contact to a lead it is of vital importance that the proper tool be used to assure seating the contact in the insulator in the proper position. Any substitution of insertion tools may result in over or under insertion of the contact which may damage the retention system of the insulator.
4. The female (socket) side of the connector has been designed with a controlled float to allow for ease of mating. To avoid reducing this float or causing a splaying of the contacts, any unnecessary strain caused by clamping the leads too close to the rear of the connector should be avoided.  
Use of recommended tooling together with proper assembly techniques will pay dividends in reliability and reduced costs.

## 2D Assembly Instructions

### WIRE STRIPPING



Cut the wires to length required and strip .100" of insulation from the end to be crimped. Check for cut or broken wires and frayed insulation.

### CONTACT CRIMPING



Using the proper crimp tool and locator, insert the contact into the locator. Insert the stripped end of the wire into the contact crimp pot, and crimp the contact to the wire. Squeeze the handles firmly to insure a proper crimp (tool will not release if crimping is incomplete).  
**NOTE:** Contact stop must be changed in tool locator when crimping pin and socket contacts.

### CONTACT INSERTION



1. Place the proper insertion tip in the insertion/-extraction handle and put the tip over the wire as shown. The tool tip will butt up against the crimp pot. Connector must be firmly supported during both insertion and extraction operations.



2. Using a firm, steady pressure, push the contact into the cavity until the resilient internal shoulder in the insulator snaps into the locking groove in the contact. The shoulder of the tool tip bottoms against the rear of the insulator, preventing over-insertion. Repeat for balance of contacts.

### CONTACT EXTRACTION



1. For contact extraction, remove the insertion tool tip and replace it with the proper extraction tool tip. (The socket tip will fit into the socket, and the pin tip will slide over the pin bundle). Insert the tool tip into the contact cavity: (the pin tip will butt up against the shoulder of the pin contact, and the socket tip will bottom out in the socket contact.)



2. Apply a firm, steady pressure until the contact is released from the internal shoulder in the insulator. The shoulder of the tool tip bottom against the insulator face to prevent damage to the internal shoulder. Remove the tool tip and pull the contact from the rear of the connector. Repeat for the balance of contacts to be removed.

## CTA Assembly Instructions

### INSERTION



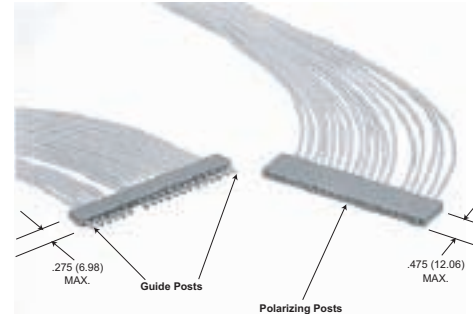
1. Place the connector into the slot in the assembly block with the arrows on the insulator pointing downward. The connector will bottom against the internal shoulder in the groove in the assembly block. Start contact insertion by placing the crimped contact in the cavity by hand.



3. With firm steady pressure, push the contact into the cavity until the resilient internal shoulder snaps into the locking groove in the contact. To prevent over insertion, the tool tip bottoms against the rear of the insulator.



2. Position the insertion tool tip on the rear of contact as shown. The insulation must be pulled back from the crimp pot approximately 1/32" to allow the tool tip to butt against the contact crimp pot.



4. The guide post and polarizing posts are inserted in the same manner as the contacts. The guide posts are inserted into the socket insulator, and the polarizing posts are inserted into the pin insulator. The corresponding contact in the mating insulator must be removed for each.

### EXTRACTION



1. To extract the contacts, place the connector face up in the assembly block so that the contact to be extracted is in the end of the block that has a fully slotted opening.



3. Insert the extraction tool into the cavity and apply firm pressure until the contact is pushed thru the rear of the connector.



2. The pin extraction tool tip is tubular, slides over the pin bundle and butts against the front shoulder of the pin. The socket extraction tool is a solid rod that fits into the socket contact, the external shoulder butts against the contact socket shoulder.



4. Lift the insulator from the groove and pull the contact out. Repeat for balance of contacts to be removed.

Dimensions shown in inch (mm)  
Specifications and dimensions subject to change

[www.ittcannon.com](http://www.ittcannon.com)



# The NANO Line - .025" Contact Spacing



NANO contacts incorporate the highly reliable Twist Pin concept, which allows continuity in very dense areas and under severe shock and vibration, requiring low engagement and separation forces. Termination can consist of uninsulated pigtailed or insulated wire all pre-harnessed at our factory to your specifications.

Due to various industry application requirements the NANO line is available in several different configurations, available in strip, metal shell and plastic, rectangular or circular configurations with center jackscrew.

Successful applications for NANO connectors are many and varied, from the Air Force's AIRS program to actual human implantations in the medical research field.

## Specifications

- Contact Rating - 1 amp max.
- Minimum contact centers - 0.025 (0.64).
- Wire sizes - #32 AWG stranded, #30 AWG solid.
- Contact termination - integral pigtail or multiple indent crimp.
- Contact retention - fixed via epoxy.
- Contact materials - socket: nickel silver.  
pin bundle: precious metal alloy or BeCu.  
pin Sleeve: nickel silver or cartridge brass.
- Mating/unmating force - 6oz. per contact max.

	NTP	NDM	NJS	NJSC	
Type	Single Row Strip	Metal Shell Rectangular	Rectangular Center Jackscrew	Circular Center Jackscrew	
Shell		Alum. alloy 2024 T351 per QQ-A-250 or 6061-T6 per QQ-A-200 nickel plate			
Insulator	Phenolic	Phenolic	Polyester	Polyester	
No. of Contacts	1-40 Contacts	9, 15, 21, 25, 31, 37	9, 24, 44	27, 72, 266	
Pin Bundle Material	- Precious metal per ASTM B477 and ASTM B541, or BeCu per CDA alloy 172 & 102 -				
Socket Sleeve Material	- Nickel silver/ASTM B122, Comp. B-				
Pin Sleeve Material	- Nickel silver per ASTM B122, Comp. B or Cartridge Brass per CDA alloy 260 -				

## Test Data

The table below summarizes the results of key tests performed in accordance with MIL-STD-202, where applicable. Data is applicable to standard connec-

tor with standard terminations. Variations may affect this data, so please consult the factory for further information on your requirements.

Test	Method	Criteria of Acceptance
Dielectric Withstanding Voltage	Method 301:	
	350 VAC at sea level 100 VAC at 70,000' altitude	No breakdown No breakdown
Insulation Resistance	Method 302, Condition A	5,000 megohms minimum
Thermal Shock	Method 107, Condition B: -65°C to +125°C	No physical damage
Physical Shock	Method 213, Condition I: 100 G's, 3-axes, 6 millisecond duration sawtooth pulse	No physical damage
		No loss of continuity > 1 μ sec
Vibration	Method 204, Condition D: 15 G's, 10-2,000 Hz, 12 hours	No physical damage No loss of continuity > 1 μ sec
Durability	500 cycles of mating and unmating, 500 CPH max.	No mechanical or electrical defect
Moisture Resistance	Method 106, omit 7b	Insulation resistance > 100 megohms
Salt Spray	Method 101, Condition B: 48 hours	Shall be capable of mating and unmating, and meet contact resistance requirements
Contact Resistance	Method 307:  At 1 amp At 100 milliamps	30 milliohms maximum } With gold plated Be-Cu Nanopin contact.
		60 milliohms maximum } With precious metal alloy Nanopin contact.
		80 milliohms maximum }
Contact Retention	-	3 lb. minimum axial load



Dimensions shown in inch (mm)  
Specifications and dimensions subject to change

www.ittcannon.com

# Strip Connectors - .025" Contact Spacing

NT

How to Order - NT



RoHS COMPLIANCE

SERIES

INSULATOR MATERIAL

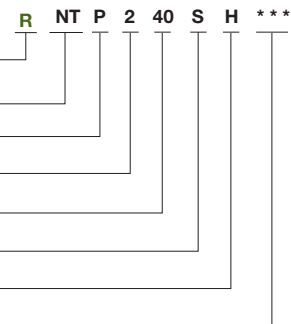
CONTACT LOCATION

CONTACT ARRANGEMENTS

CONTACT TYPE

TERMINATION TYPE

MODIFICATION CODE



## SERIES

Nano Strip

## INSULATOR MATERIAL

P - Phenolic

## CONTACT LOCATION

- 1 - Contacts on .025 (0.64) centers
- 2 - Contacts on .050 (1.27) centers

## CONTACT ARRANGEMENTS

- 40 Maximum - .025 (0.64) centers
- 20 Maximum - .050 (1.27) centers

## CONTACT TYPE

- P - Pin (Plug)
- S - Socket (Receptacle)

## TERMINATION MODIFICATION

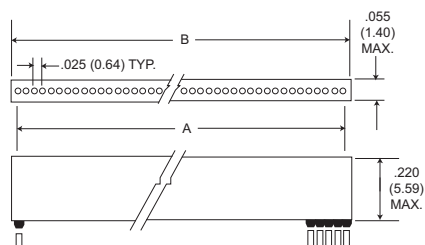
- L - Solid uninsulated wire
- T - One piece contact/lead
- H - Insulated harness wire

## MODIFICATION CODE

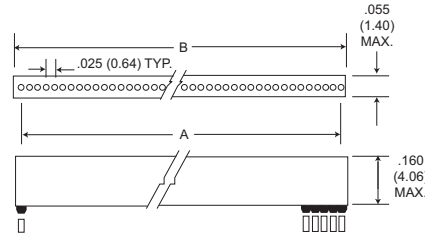
For termination code, see NJS section, page 73.

## Dimensions

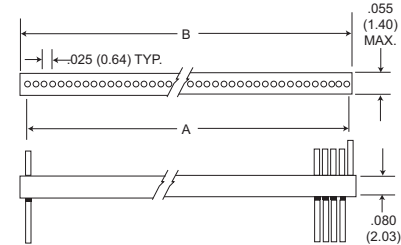
### NTP



Plug - "H" and "L" Termination Types



Plug - "T" Termination Types



Receptacle - "H", "L", and "T" Termination Types

Part Number by Insulator Size	A Ref.	B ±.010 (0.25)	Part Number by Insulator Size	A Ref.	B ±.010 (0.25)	Part Number by Insulator Size	A Ref.	B ±.010 (0.25)	Part Number by Insulator Size	A Ref.	B ±.010 (0.25)
NTPI-1*-**	-	.050 (1.27)	NTPI-11*-**	.250 (6.35)	.300 (7.62)	NTPI-21*-**	.500 (12.70)	.550 (13.97)	NTPI-31*-**	.750 (19.05)	.800 (20.32)
NTPI-2*-**	.025 (0.64)	.075 (1.91)	NTPI-12*-**	.275 (6.99)	.325 (8.26)	NTPI-22*-**	.525 (13.34)	.575 (14.61)	NTPI-32*-**	.775 (19.69)	.825 (20.96)
NTPI-3*-**	.050 (1.27)	.100 (2.54)	NTPI-13*-**	.300 (7.62)	.350 (8.89)	NTPI-23*-**	.550 (13.97)	.600 (15.24)	NTPI-33*-**	.800 (20.32)	.850 (21.59)
NTPI-4*-**	.075 (1.91)	.125 (3.18)	NTPI-14*-**	.325 (8.26)	.375 (9.53)	NTPI-24*-**	.575 (14.61)	.625 (15.88)	NTPI-34*-**	.825 (20.96)	.875 (22.23)
NTPI-5*-**	.100 (2.54)	.150 (3.81)	NTPI-15*-**	.350 (8.89)	.400 (10.16)	NTPI-25*-**	.600 (15.24)	.650 (16.51)	NTPI-35*-**	.850 (21.59)	.900 (22.86)
NTPI-6*-**	.125 (3.18)	.175 (4.45)	NTPI-16*-**	.375 (9.53)	.425 (10.80)	NTPI-26*-**	.625 (15.88)	.675 (17.15)	NTPI-36*-**	.875 (22.23)	.925 (23.50)
NTPI-7*-**	.150 (3.81)	.200 (5.08)	NTPI-17*-**	.400 (10.16)	.450 (11.43)	NTPI-27*-**	.650 (16.51)	.700 (17.78)	NTPI-37*-**	.900 (22.86)	.950 (24.13)
NTPI-8*-**	.175 (4.45)	.225 (5.72)	NTPI-18*-**	.425 (10.80)	.475 (12.07)	NTPI-28*-**	.675 (17.15)	.725 (18.42)	NTPI-38*-**	.925 (23.50)	.975 (24.77)
NTPI-9*-**	.200 (5.08)	.250 (6.35)	NTPI-19*-**	.450 (11.43)	.500 (12.70)	NTPI-29*-**	.700 (17.78)	.750 (19.05)	NTPI-39*-**	.950 (24.13)	1.000 (25.40)
NTPI-10*-**	.225 (5.72)	.275 (6.99)	NTPI-20*-**	.475 (12.07)	.525 (13.34)	NTPI-30*-**	.725 (18.42)	.775 (19.69)	NTPI-40*-**	.975 (24.77)	1.025 (26.04)

Dimensions shown in inch (mm)

Specifications and dimensions subject to change

www.ittcannon.com



How to Order - NDM



RoHS COMPLIANCE

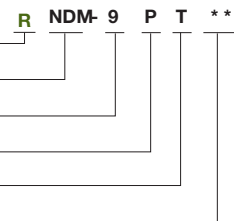
SERIES

CONTACT ARRANGEMENTS

CONTACT TYPE

TERMINATION TYPE

MODIFICATION CODE



**SERIES**

NDM - NANO D Metal Shell

**CONTACT ARRANGEMENTS**

9, 15, 21, 25, 31, 37

**CONTACT TYPE**

P = Pin (Plug)

S = Socket (Receptacle)

**TERMINATION TYPE**

H = Insulated harness wire

L = Solid copper

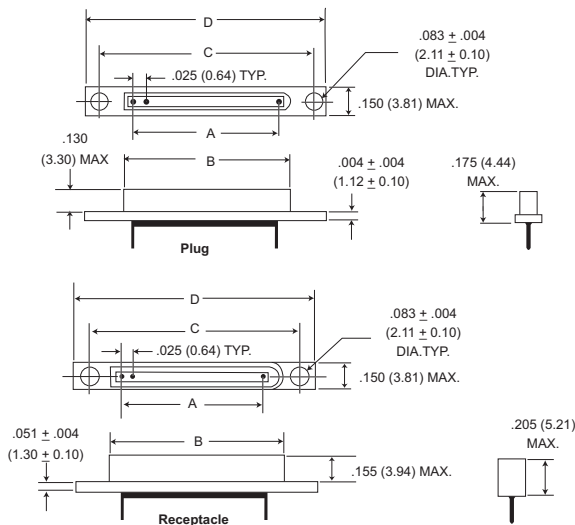
T = One piece contact/lead

**MODIFICATION CODE**

To specify lead lengths, type and mechanical modifications consult customer service.

## Dimensions

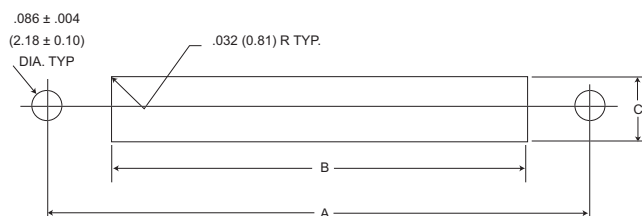
### NDM



Part Number By Shell Size	A Ref.	Plug B Ref.	Receptacle		D Max.
			B Ref.	C ±.005 (0.13)	
NDM-9P*/S*	.200 (5.08)	.317 (8.05)	.380 (9.65)	.565 (14.35)	.725 (18.42)
NDM-15P*/S*	.350 (8.89)	.467 (11.86)	.530 (13.46)	.715 (18.16)	.875 (22.23)
NDM-21P*/S*	.500 (12.7)	.617 (15.67)	.680 (17.27)	.865 (21.97)	1.025 (26.04)
NDM-25P*/S8	.600 (15.24)	.717 (18.21)	.780 (19.81)	.965 (24.51)	1.125 (28.58)
NDM-31P*/S*	.750 (19.05)	.867 (22.02)	.930 (23.62)	1.115 (28.32)	1.275 (32.39)
NDM-37P*/S*	.900 (22.86)	1.017 (25.83)	1.080 (27.43)	1.265 (32.13)	1.425 (36.20)

Consult customer service for availability of other sizes.

## Panel Mounting Dimensions



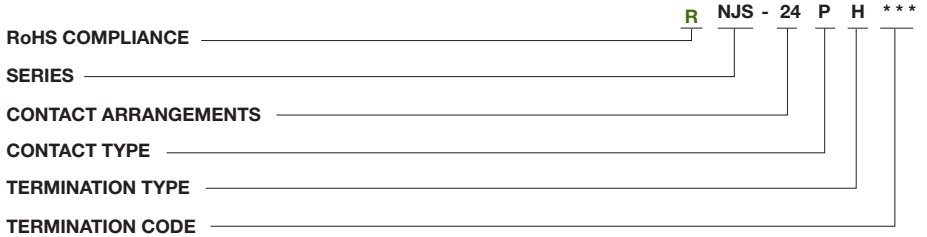
Size	A	B	C
	±.005 (0.13)	+ .005 (0.13) - .000 (0.00)	+ .005 (0.13) - .000 (0.00)
9	.565 (14.35)	.261 (6.63)	.095 (2.41)
15	.715 (18.16)	.411 (10.44)	.095 (2.41)
21	.865 (21.97)	.561 (14.25)	.095 (2.41)
25	.965 (24.51)	.661 (16.79)	.095 (2.41)
31	1.115 (28.32)	.811 (20.60)	.095 (2.41)
37	1.265 (32.13)	.961 (24.41)	.095 (2.41)



Dimensions shown in inch (mm)  
Specifications and dimensions subject to change

www.ittcannon.com

## How to Order - NJS



**SERIES**  
 NJS - Nano center jackscrew rectangular (9, 24, 44)  
 NJSC - Nano center jackscrew circular (27, 72, 266)

**CONTACT ARRANGEMENTS**  
 9, 24, 27, 44, 72, 266

**CONTACT TYPE**  
 P = Pin (Plug)  
 S = Socket (Receptacle)

**TERMINATION TYPE**  
 H = Insulated harness wire  
 L = Solid uninsulated wire  
 T = One piece contact/Lead

\* See Termination Codes shown below for additional length modification codes.

**TERMINATION CODE\***

(H) 001 = 18" #32 AWG 7/40 strd. Type "ET" Teflon per MIL-W-16878/6, color yellow.  
 (H) 003 = 18" #32 AWG 7/40 strd. Type "ET" Teflon per MIL-W-16878/6 color coded to MIL-STD-681, System 1.  
 (L) 1 = 1/2" uninsulated solid #30 AWG gold plated copper.  
 (L) 2 = 1" uninsulated solid #30 AWG gold plated copper  
 (T)\* = Consult customer service

## Standard Wire Termination Codes

The following termination codes are listed for your information. For additional codes please refer to Appendix on page 80 and 82. **All wire lengths are minimum.**

**Harness Type (H)**

#32 AWG, 7/40 stranded, Type "ET" per MIL-W-16878/6

Length	All Yellow	Color Coded
3 (76.2)	H 020	H 027
6 (152.4)	H 019	H 016
8 (203.2)	H 026	H 034
10 (254.0)	H 029	H 025
12 (304.8)	H 028	H 002
18 (457.2)	H 001	H 003
20 (508.0)	H 038	H 023

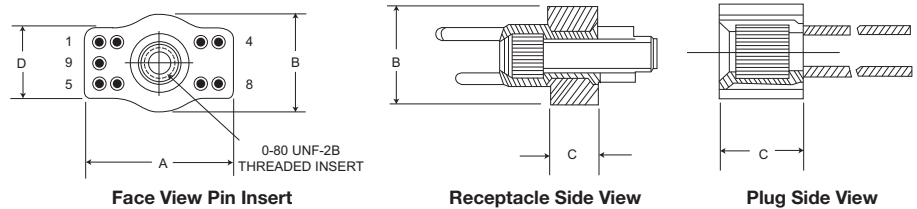
**Solid Uninsulated Type (L)**

#32 AWG gold plated copper.

Length	All Yellow	Color Coded	Code	Length	Code	Length
24 (609.6)	H 009	H 004	L61	.125 (3.18)	L14	.750 (19.05)
30 (762.0)	H 010	H 005	L56	.150 (3.81)	L2	1.000 (25.40)
36 (914.4)	H 011	H 006	L57	.190 (4.83)	L7	1.500 (38.10)
48 (1219.2)	H 013	H 048	L39	.250 (6.35)	L6	2.000 (50.80)
72 (1828.8)	H 017	H 046	L58	.375 (9.53)	L16	2.500 (63.50)
120 (3048.0)	H 042	H 041	L1	.500 (12.70)	L10	3.000 (76.20)

## Center Jackscrew/Rectangular

**NJS-9 & NJS-24**



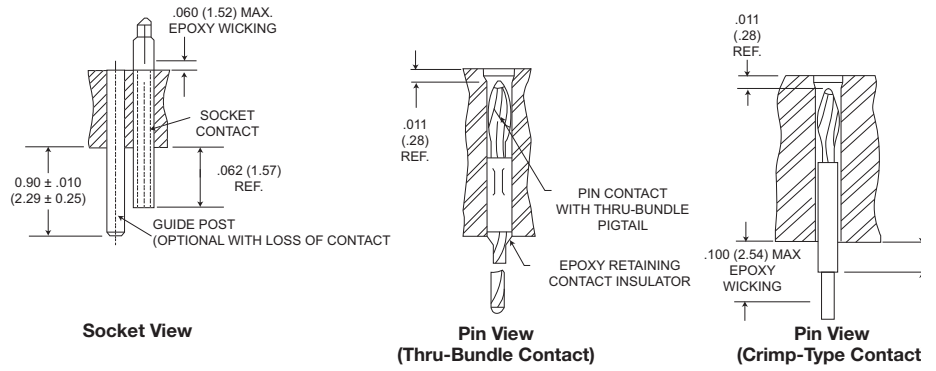
Part Number	A Max.	B Max.	C ±.005 (0.13)	D ±.005 (0.13)
NJS-9P*	.255 (6.48)	.165 (4.19)	.138 (3.51)	.116 (2.95)
NJS-9S*	.255 (6.48)	.165 (4.19)	.078 (1.98)	.116 (2.95)
NJS-24P*	.435 (11.05)	.165 (4.19)	.138 (3.51)	.116 (2.95)
NJS-24S*	.435 (11.05)	.165 (4.19)	.078 (1.98)	.116 (2.95)
NJSC-266		.165 (4.19)		.116 (2.95)
NJSC-72		.165 (4.19)		.116 (2.95)
NJSC-44		.165 (4.19)		.116 (2.95)
NJSC-27		.165 (4.19)		.116 (2.95)

Dimensions shown in inch (mm)  
 Specifications and dimensions subject to change

www.ittcannon.com



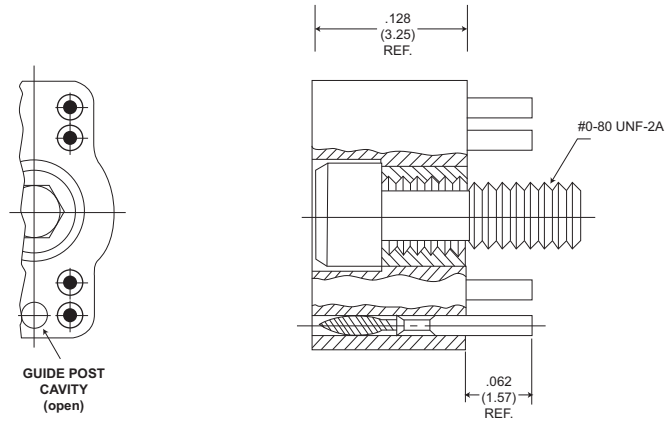
## Contacts



NOTE: Guide posts can be installed in any contact cavity for polarization purposes.

## Connector Saver

### NJS-9P & S



Part Number: NJS97294-835

# Custom Cable Assemblies



## Dynamic Custom Cable Assemblies for Harsh Environments

ITT has been a world leader in designing and manufacturing harsh environment micro interconnects and cable assemblies for over fifty years. In addition, our historical product and assembly expertise dates back over 85 years to the founding of the original ITT Cannon. Today, we provide complete turnkey cable assemblies for all of ITT's micro connector portfolio including: Cent Line Interconnects, MDM series, M83513 Series, MEB series, MDM Mixed Signal Packages, MT strip interconnects, micro miniature circular MIK series, and our high density Nano Connectors. Our cable assembly expertise has allowed ITT to develop innovative Six Sigma driven manufacturing processes that allows our customers a full breadth of tight pitch cable assemblies in 0.100, 0.075, 0.050, and 0.025 contact spacing.

ITT's harsh environment interconnects and cable assemblies are used in the most demanding applications and environments. You will find our products in such markets as: Aerospace, Defense Electronics, Geophysical Exploration, High Speed Computer Networking, Industrial Automation, Medical Electronics, Satellite and Space Communications, and Telecommunications. Our complete interconnect solutions have flown on every major Aircraft and Space platform since the 1940's. In fact, many aircraft mechanics still refer to ITT Cannon connector and cable assemblies as the Aviation standard.

Our product portfolio has been developed and is continuing to be developed to provide our customers with new and better technologies that offer superior system level performance while lowering overall system level costs. Our corporate culture in Six Sigma Methodologies allows ITT to continuously challenge our Engineering and Scientific professionals to develop new processes and technologies in Material Science, Automation, and Testing to ensure that our customers get the best cost effective harsh environment cable assemblies from ITT. You should expect no less from an Industry leader.

The following paragraphs highlight several examples of interconnect cable assemblies for various Market segments that ITT services. These examples represent just a snapshot of the many custom micro interconnects or cable assemblies that ITT can provide the industry.



## Custom Micro D and M83513 Interconnect cable assemblies

As one of the original developers of the Micro Interconnect technology, ITT has been an industry innovator in providing complete harsh environment cable assemblies and stretching the state of art in such areas as: Filtering, Hermetics, moisture barriers, High Speed and Mixed Signal Packages, EMI suppression, and multiple cable types. Most of ITT's custom cable assemblies utilize our standard Micro pin contact system. However, ITT does use other types of contact systems when manufacturing mixed signal interconnect systems where signal speed and power contacts will be incorporated into a complete cable assembly solution.

ITT manufactures complete cable assemblies worldwide at locations in Santa Ana California, Basingstoke UK, and Nogales Mexico. The various engineering and manufacturing centers of excellence are utilized to best fit various cable assembly and product platform specialties to provide our customers with the most cost effective solutions.



## Space Grade Micro Interconnect cable assemblies

ITT has been deciding and manufacturing Space Rated interconnects and cable assemblies since the beginning of the US space Program in the mid 20th century. Prior to the MIL DTL M83513 specification ITT had been qualified for all NASA GSFC performance and specification requirements, on numerous satellite and space launch systems. ITT's Engineering and Product teams have over 200 years of combined experience in design, manufacture, and test of Space flight interconnects and cable assemblies. Our expertise in material science, manufacturing processes, out gassing, testing and screening, Magnetic permeability, and Cryogenics has given ITT a tremendous understanding in developing high reliability space system interconnects and cable assemblies .

All of ITT's Space rated micro interconnect assemblies utilize ITT QPL M83513 connectors. These cable assemblies are tested to meet the most stringent performance requirements as outlined by numerous NASA GSFC specifications. Additional performance and test requirements beyond existing NASA GSFC guidelines can always be tailored so that additional custom test programs can be incorporated.

# Custom Cable Assemblies

## High Temperature Harsh Environment Interconnect Assemblies

The proliferation of deep water drilling prospects in the world's oceans has created increased performance demands for micro miniature interconnects and cable assemblies for down hole oil field exploration. Not only are new fields being discovered in ocean depths greater than five miles but the wells themselves are being drilled deeper into the earth's crust, sometimes to depths of 30,000 feet. Thus, the temperature extremes in excess of 200 degrees C are becoming the norm. In this the most demanding of environments, ITT has been designing and manufacturing such micro interconnect connector and cable assemblies for over forty years. Again our engineering and manufacturing expertise in the material science of Liquid Crystal Polymer (LCP), fluorosilicones, plating, metals, and high temperature epoxies is leading ITT to develop high temperature performance beyond 200 degree C operating temperatures.

Pictured below is an ITT high temperature nano interconnect assembly. ITT is developing new products around this nano interconnect platform that will not only increase signal density but will include new material's and processes for higher temperature applications.



## Medical Electronics Cable Assemblies:

As microminiaturization continues in the medical technologies field so the contributions of ITT's micro interconnect devices and assemblies. Our custom medical assemblies are utilized in such applications as: patient monitoring, diagnostics, imaging, and disposable systems. These types of application have been well served by ITT's Nano, MT strip and MIKQ series of interconnects. In addition to there specific connector types, ITT is well experienced in the careful selection of medical grade cables and termination materials to ensure fully compliant med. cal cable assemblies.

Shown below is an example of ITT's MIKQ high strength plastic circular quick disconnect connector cable assembly for a medical application.



# Flex Circuit Cable Assembly

## Terminating to Flexible Circuits



Ideally, for a low profile and a neat finish, it is best to terminate flexible circuits in line with the contacts. Since most Microminiature connectors have contacts set into two or three rows, termination is a simple process.

The diagrams opposite are basically a design guide for pad arrangements, to suit MDM connectors in particular and to ensure the circuits enter the potting well. The length of the pad is optional but of course it is important to provide enough coverlay, especially at the edges of the circuit, to avoid de-lamination. We suggest at least 0,51 mm (.020 inches). Our standard potting shrouds provide support to the circuit with a dimension of 7,00 mm (.275 inches) from the rear of the flange.

Please consult Customer Service for specific flex circuit assembly design considerations and requirements.

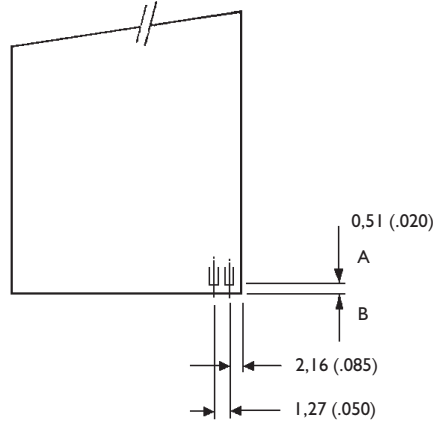
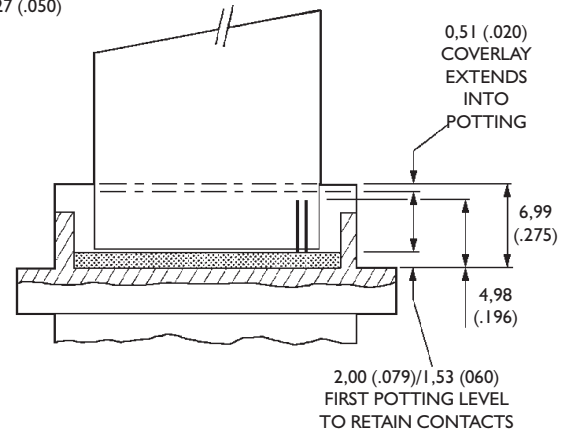


Diagram 1 shows details of the pad spacing and the suggested amount of material to be left between the end of the pad A and the edge of the flex B.

Diagram 2 illustrates how the connector is prepared with short pigtails and a special first pot which just captures the contacts. The final back potting for strength is controlled by our standard 7,00 (.275) potting fixtures.



## Custom Back Shell Systems

ITT has designed numerous back shell solutions for micro miniature interconnects for many harsh environment applications. Although ITT does not offer a standard back shell portfolio today, we can design and manufacture a range of back fittings for our MDM connector products depending on the customer requirements. Utilizing one of our partnership relationships, one of our UK based micro product groups of ITT can provide can provide custom designs utilizing proven banded systems in which the braid is captivated over a chimney style outlet. These types of back shell systems are available in

different material finishes and sizes and can be provided with special process termination methods. In addition, ITT has developed a method of riveting the back fitting to the shell within the jacking area. This option guarantees 360 degree shielding effectiveness even when jackscrews or jacking posts are not being used.

Where a conduit system is preferred such as for test box environments in field locations, back fittings and a fully screened weatherproof convoluted trunking can be provided

In addition to the above ITT can provide special back potting style termination systems for environmental protection and strain relief. These types of a back shell style system are typically filled with epoxy or other encapsulating materials to provide a robust and effective back shell system.

## Sealing Gaskets

We have received requests for gasket materials to seal the MDM connectors into various enclosures. We recommend that you consider wider flanged connectors together with a low cost conductive gasket to provide an adequate surface area. This combination will give you IP-66 sealing with good EMC compliance. The following dimensions for gaskets and flange dimensions are regarded as the minimum that you should consider.

Conductive elastomers generally offer a superior shielding performance when compared with alternatives as in table below.

Gasket Type	Neoprene (wire impregnated)	Silicone (wire impregnated)	Silicone (oriented wire)	Neoprene (fabric wrap)	Metallic finger stock	Metallic fibres	Conductive silicone rubber
Shielding performance	S	S	G	G	G	G	G
Temperature range	S	G	G	S	G	G	G
IP sealing	P	P	S	S	P	P	G
Compression force	G	G	G	G	G	S	S
Compression range	S	S	S	G	G	P	S
Surface texture	P	P	G	P	G	P	S
Compression set	S	S	S	S	G	P	G
Re-usability	S	S	S	S	G	P	G

\* Neoprene is a trademark of Dupont P = Poor S = Satisfactory G = Good

Conductive rubber gaskets can be loaded with many different metallic fillers but the choice of material is dependent upon a number of factors such as level of conductivity, shielding effectiveness, galvanic compatibility and cost.

Galvanic Corrosion can occur when two dissimilar metals are in contact with one another in the presence of an electrolyte. The type of gasket material has to be assessed because of the use of metallic fillers. Many applications are dry indoor environments where corrosion is not a major concern. However, for external use, particularly marine, it is recommended that consideration be given to compatibility. The table on the next page is a summary.

Enclosure Material	Silver/Nickel	Silver/Copper	Silver/aluminum	Inert aluminum	Silver/Glass	Silver	Nickel/Graphite	Nickel
aluminum alloys	X	X	□	▲	X	X	□	□
Magnesium alloys	X	X	□	□	X	X	□	□
Stainless steel	▲	▲	▲	▲	▲	▲	▲	▲
Copper alloys	▲	▲	▲	▲	▲	▲	▲	▲
Cadmium plating	X	X	□	□	X	X	□	□
Tin plating	□	X	□	▲	□	□	▲	▲
Nickel plating	▲	□	□	▲	▲	▲	▲	▲
Chromium plating	▲	▲	▲	▲	▲	▲	▲	▲
Silver plating	▲	▲	▲	▲	▲	▲	▲	▲
Zinc & galvanise plating	X	X	□	□	X	X	□	□
Titanium	▲	▲	▲	▲	▲	▲	▲	▲

▲ = good □ = Satisfactory X = Not recommended



Dimensions shown in inch (mm)  
Specifications and dimensions subject to change

www.ittcannon.com

# Appendix

## "L" Code Chart

SORTED BY LENGTH			SORTED BY CODE		
Wire Length, IN.			Wire Length, IN.		
Decimal	Fraction	Code	Code	Decimal	Fraction
0.080		L63	L1	0.500	1/2
0.094	3/32	L62	L2	1.000	
0.110		L65	L3	6.000	
0.125	1/8	L61	L4	12.000	
0.140		L67	L5	20.000	
0.150		L56	L6	2.000	
0.171		L66	L7	1.500	
0.187	3/16	L17	L8	7.000	
0.190		L57	L9	5.000	
0.210		L59	L10	3.000	
0.250	1/4	L39	L11	4.000	
0.312	3/8	L60	L12	0.625	5/8
0.375	3/8	L58	L13	10.000	
0.380		L64	L14	0.750	3/4
0.500	1/2	L1	L15	3.500	
0.625	5/8	L12	L16	2.500	
0.750	3/4	L4	L17	0.187	3/16
1.000		L2	L18	8.000	
1.500		L7	L25	2.250	
2.000		L6	L28	4.500	
2.250		L25	L39	0.250	1/4
2.500		L16	L45	9.000	
3.000		L10	L46	15.000	
3.500		L15	L52	11.500	
4.000		L11	L55	18.000	
4.500		L28	L56	0.150	
5.000		L9	L57	0.190	
6.000		L3	L58	0.375	3/8
7.000		L8	L59	0.210	
8.000		L18	L60	0.312	5/16
9.000		L45	L61	.0125	1/8
10.000		L13	L62	0.094	3/32
11.500		L52	L63	0.080	
12.000		L4	L64	0.380	
15.000		L46	L65	0.110	
18.000		L55	L66	0.171	
20.000		L5	L67	0.140	

#25AWG, SOLID COPPER WIRE PER QQ-W-343, TYPE "S", GOLD PLATED PER MIL-G-45204, TYPE II GRADE C OR D, CLASS 1 (50 MICROINCHES MINIMUM)

**Nano "L" Code Charts on page 80.**

# Appendix

## "L" Code Chart (for Nano products only)

SORTED BY LENGTH			SORTED BY CODE		
Wire Length, IN.			Wire Length, IN.		
Decimal	Fraction	Code	Code	Decimal	Fraction
0.080		L63	L1	0.500	1/2
0.094	3/32	L62	L2	1.000	
0.110		L65	L3	6.000	
0.125	1/8	L61	L4	12.000	
0.140		L67	L5	20.000	
0.150		L56	L6	2.000	
0.171		L66	L7	1.500	
0.187	3/16	L17	L8	7.000	
0.190		L57	L9	5.000	
0.210		L59	L10	3.000	
0.250	1/4	L39	L11	4.000	
0.312	3/8	L60	L12	0.625	5/8
0.375	3/8	L58	L13	10.000	
0.380		L64	L14	0.750	3/4
0.500	1/2	L1	L15	3.500	
0.625	5/8	L12	L16	2.500	
0.750	3/4	L4	L17	0.187	3/16
1.000		L2	L18	8.000	
1.500		L7	L25	2.250	
2.000		L6	L28	4.500	
2.250		L25	L39	0.250	1/4
2.500		L16	L45	9.000	
3.000		L10	L46	15.000	
3.500		L15	L52	11.500	
4.000		L11	L55	18.000	
4.500		L28	L56	0.150	
5.000		L9	L57	0.190	
6.000		L3	L58	0.375	3/8
7.000		L8	L59	0.210	
8.000		L18	L60	0.312	5/16
9.000		L45	L61	.0125	1/8
10.000		L13	L62	0.094	3/32
11.500		L52	L63	0.080	
12.000		L4	L64	0.380	
15.000		L46	L65	0.110	
18.000		L55	L66	0.171	
20.000		L5	L67	0.140	

#30AWG, SOLID COPPER WIRE PER QQ-W-343, TYPE "S", GOLD PLATED PER MIL-G-45204, TYPE II GRADE C OR D, CLASS 1 (50 MICROINCHES MINIMUM)



Dimensions shown in inch (mm)  
Specifications and dimensions subject to change

[www.ittcannon.com](http://www.ittcannon.com)

# Appendix

## "H" Code Charts

16878/4

Wire, Electrical, Polytetrafluorethylene (PTFE) Insulated, 200 Degrees C, 600 Volts, Extruded Insulation

Length	Yellow	White	System 1
1	030	C30	A30
2	024	C24	A24
3	020	C20	027
4	-	C33	033
5	031	C31	A31
6	019	047	016
8	026	C26	034
9	015	C15	A15
10	029	C29	025
12	028	008	002
16	039	C39	A39
17	036	C36	A36
18	001	044	003
20	038	C38	023
21	055	C55	A55
24	009	045	004
30	010	C10	005
35	018	C18	A18
36	011	058	006
40	037	C37	A37
42	012	021	A12
48	013	C13	048
50	040	C40	A40
60	014	C14	056
72	017	059	046
80	032	C32	A32
92	022	C22	A22
96	035	C35	A35
120	042	C42	041
180	043	C43	A43

22759/11-26

Wire, Electrical, Fluoropolymer-Insulated, Extruded TFE, Silver-Coated Copper Conductor, 600 Volt

Length	White	10 Color Repeat	System 1
1	G30	Y30	H30
2	G24	Y24	H24
3	G20	Y20	H20
4	G33	Y33	H33
5	G31	Y31	H31
6	065	Y19	072
8	G26	Y26	H26
9	G15	Y15	H15
10	G29	Y29	H29
12	066	Y28	073
16	G39	Y39	H39
17	G36	Y36	H36
18	067	Y01	074
20	G38	Y38	H38
21	G55	Y55	H55
24	068	Y09	075
30	G10	Y10	H10
35	G18	Y18	H18
36	069	Y11	076
40	G37	Y37	H37
42	G12	Y12	H12
48	070	Y13	077
50	G40	Y40	H40
60	G14	Y14	H14
72	071	Y17	078
80	G32	Y32	H32
92	G22	Y22	H22
96	G35	Y35	H35
120	G42	Y42	H42
180	G43	Y43	H43

22759/33-26

Wire, Electrical, Fluoropolymer-Insulated, Crosslinked Modified, ETFE, Lightweight, Silver-Coated, High-Strength Copper Alloy 200 Degrees C, 600 Volt

Length	White	10 Color Repeat	System 1
1	V30	W30	X30
2	V24	W24	X24
3	V20	W20	X20
4	V33	W33	X33
5	V31	W31	X31
6	V19	W19	X19
8	V26	W26	X26
9	V15	W15	X15
10	V29	W29	X29
12	V28	W28	X28
16	V39	W39	X39
17	V36	W36	X36
18	V01	W01	X01
20	V38	W38	X38
21	V55	W55	X55
24	V09	W09	X09
30	V10	W10	X10
35	V18	W18	X18
36	V11	W11	X11
40	V37	W37	X37
42	V12	W12	X12
48	V13	W13	X13
50	V40	W40	X40
60	V14	W14	X14
72	V17	W17	X17
80	V32	W32	X32
92	V22	W22	X22
96	V35	W35	X35
120	V42	W42	X42
180	V43	W43	X43

Nano "H" Code Charts on page 82.

Dimensions shown in inch (mm)  
Specifications and dimensions subject to change

www.ittcannon.com



# Appendix

## "H" Code Charts (for Nano products only)

MIL-W-16878/6

Wire, Electrical, Polytetrafluorethylene (PTFE)  
Insulated, 200 Degrees C, 250 Volts, Extruded  
Insulation

Length	Yellow	White	System 1
1	030	C30	A30
2	024	C24	A24
3	020	C20	027
4	-	C33	033
5	031	C31	A31
6	019	047	016
8	026	C26	034
9	015	C15	A15
10	029	C29	025
12	028	008	002
16	039	C39	A39
17	036	C36	A36
18	001	044	003
20	038	C38	023
21	055	C55	A55
24	009	045	004
30	010	C10	005
35	018	C18	A18
36	011	058	006
40	037	C37	A37
42	012	021	A12
48	013	C13	048
50	040	C40	A40
60	014	C14	056
72	017	059	046
80	032	C32	A32
92	022	C22	A22
96	035	C35	A35
120	042	C42	041
180	043	C43	A43

# Appendix

## MIL-STD-681 Wire Color Code

### Reference Data

PIN No.	MIL-STD-681 No.	Base Color	First Stripe	Second Stripe	Third Stripe	PIN No.	MIL-STD-681 No.	Base Color	First Stripe	Second Stripe	Third Stripe
1*	0	BLK				51	957	WHT	GRN	VIO	
2*	1	BRN				52	958	WHT	GRN	GRY	
3*	2	RED				53	967	WHT	BLU	VIO	
4*	3	ORN				54	968	WHT	BLU	GRY	
5*	4	YEL				55	978	WHT	VIO	GRY	
6*	5	GRN				56	9012	WHT	BLK	BRN	RED
7*	6	BLU				57	9013	WHT	BLK	BRN	ORN
8*	7	VIO				58	9014	WHT	BLK	BRN	YEL
9*	8	GRY				59	9015	WHT	BLK	BRN	GRN
10*	9	WHT				60	9016	WHT	BLK	BRN	BLU
11	90	WHT	BLK			61	9017	WHT	BLK	BRN	VIO
12	91	WHT	BRN			62	9018	WHT	BLK	BRN	GRY
13	92	WHT	RED			63	9023	WHT	BLK	RED	ORN
14	93	WHT	ORN			64	9024	WHT	BLK	RED	YEL
15	94	WHT	YEL			65	9025	WHT	BLK	RED	GRN
16	95	WHT	GRN			66	9026	WHT	BLK	RED	BLU
17	96	WHT	BLU			67	9027	WHT	BLK	RED	VIO
18	97	WHT	VIO			68	9028	WHT	BLK	RED	GRY
19	98	WHT	GRY			69	9034	WHT	BLK	ORN	YEL
20	901	WHT	BLK	BRN		70	9035	WHT	BLK	ORN	GRN
21	902	WHT	BLK	RED		71	9036	WHT	BLK	ORN	BLU
22	903	WHT	BLK	ORN		72	9037	WHT	BLK	ORN	VIO
23	904	WHT	BLK	YEL		73	9038	WHT	BLK	ORN	GRY
24	905	WHT	BLK	GRN		74	9045	WHT	BLK	YEL	GRN
25	906	WHT	BLK	BLU		75	9046	WHT	BLK	YEL	BLU
26	907	WHT	BLK	VIO		76	9047	WHT	BLK	YEL	VIO
27	908	WHT	BLK	GRY		77	9048	WHT	BLK	YEL	GRY
28	912	WHT	BRN	RED		78	9056	WHT	BLK	GRN	BLU
29	913	WHT	BRN	ORN		79	9057	WHT	BLK	GRN	VIO
30	914	WHT	BRN	YEL		80	9058	WHT	BLK	GRN	GRY
31	915	WHT	BRN	GRN		81	9067	WHT	BLK	BLU	VIO
32	916	WHT	BRN	BLU		82	9068	WHT	BLK	BLU	GRY
33	917	WHT	BRN	VIO		83	9078	WHT	BLK	VIO	GRY
34	918	WHT	BRN	GRY		84	9123	WHT	BRN	RED	ORN
35	923	WHT	RED	ORN		85	9124	WHT	BRN	RED	YEL
36	924	WHT	RED	YEL		86	9125	WHT	BRN	RED	GRN
37	925	WHT	RED	GRN		87	9126	WHT	BRN	RED	BLU
38	926	WHT	RED	BLU		88	9127	WHT	BRN	RED	VIO
39	927	WHT	RED	VIO		89	9128	WHT	BRN	RED	GRY
40	928	WHT	RED	GRY		90	9134	WHT	BRN	ORN	YEL
41	934	WHT	ORN	YEL		91	9135	WHT	BRN	ORN	GRN
42	935	WHT	ORN	GRN		92	9136	WHT	BRN	ORN	BLU
43	936	WHT	ORN	BLU		93	9137	WHT	BRN	ORN	VIO
44	937	WHT	ORN	VIO		94	9138	WHT	BRN	ORN	GRY
45	938	WHT	ORN	GRY		95	9145	WHT	BRN	YEL	GRN
46	945	WHT	YEL	GRN		96	9146	WHT	BRN	YEL	BLU
47	946	WHT	YEL	BLU		97	9147	WHT	BRN	YEL	VIO
48	947	WHT	YEL	VIO		98	9148	WHT	BRN	YEL	GRY
49	948	WHT	YEL	GRY		99	9156	WHT	BRN	GRN	BLU
50	956	WHT	GRN	BLU		100	9157	WHT	BRN	GRN	VIO

\* 10 colors repeat is the standard wire color code for MIL-DTL-83513 connectors.



# Terminology

---

**Adhesive dispensing:** a computer-controlled machine automatically dispenses epoxy adhesive.

**Backmolding:** this term refers to the process of transfer-molding epoxy performs into a mold. The epoxy is heated and pressurized, much like conventional plastic molding.

**Backpotting:** the application of epoxy to connector wire terminations for strain relief and sealing. Epoxy is dispensed with pneumatic syringes. Standard Micro products have built-in potting wells to contain the epoxy, but optional potting in custom configurations is accomplished with inexpensive molds.

**Brady labels:** wraparound adhesive labels for multi-conductor cable.

**Breakout:** the area where one or more cables are joined together. A breakout frequently requires splices and extra strain relief such as cable ties or tubing.

**Electrical testing:** Hi-pot, insulation resistance, and continuity testing are standard tests for cable assemblies.

**Etching:** etching is a chemical process to prepare certain types of Teflon insulated wire for potting. Without etching, the epoxy will not bond properly.

**Expando:** braided sleeving used to protect a wire bundle. The simplest and least expensive method of jacketing a cable, expando tubing is made of abrasion-resistant nylon or other materials. The ends of the tubing are usually encapsulated in epoxy.

**Header:** a general term for any printed circuit board mounted connector used as an I/O port.

**Hot stamping:** insulated wire is imprinted with identification numbers or text.

**Hot-stamped heat shrink tubing:** used for multi-conductor cables, heat shrink tubing is impression stamped, then installed on the cable and shrunk.

**Ink-jet marking:** dots of ink are sprayed through a stationary nozzle onto a part moving on a conveyor. Ink jet marking is now standard.

**Ink-stamping:** the traditional method of placing metal type in a marking machine which is inked with a roller. The metal type transfers the ink to a rubber pad, and the part is pressed onto the pad. Oven curing is required.

**Jumper Cable:** this term usually applies to a short cable assembly that plugs into a printed circuit board one end, with the other end mounted in an I/O panel.

**Lacing:** the process of tying individual wires together into bundles. Special lacing tape is used.

**Laser stripping:** insulation is removed from the wire by using a special laser stripping machine. Typically used on flat cable.

**Mass-termination:** simultaneous termination of multiple contacts. Normally associated with IDC termination, mass termination is also used on micropins in a special multi-contact crimp tool.

**Pigtail:** a single-ended cable assembly having one connector on one end and unterminated wire on the other end.

**Potting:** the application of various adhesives to a connector. Potting encapsulates the wires or terminals, providing environmental sealing and strain relief.

**Silkscreening:** Ink is transferred through a screen.

**Stripping:** insulation is removed from wire ends on automatic cut and strip equipment.

**Thermal Shock:** a conditioning environmental test that cycles a part repeatedly through a specified temperature range. Thermal shock is frequently performed prior to pressure testing.

**Tinning:** the application of molten solder to connector terminals. Micro products are tinned on a fully automatic machine with cleaning, pre-heating and inert gas tinning. Pre-tinned leads ensure excellent solderability.

**Wire marking:** individual numbered adhesive tags are attached to each wire.

**Wire striping:** insulated wire from #24 thru #28 AWG is striped with colors for circuit identification.

**Wiring fixtures:** flat wiring boards or more complicated three-dimensional fixtures are required for many multi-branched cable harnesses. Mating connectors are fixtured in the exact position of the end use equipment, and the cable assembly is built on the fixture.

# Product Safety Information

**THIS NOTE MUST BE READ IN CONJUNCTION WITH THE PRODUCT DATA SHEET/CATALOG. FAILURE TO OBSERVE THE ADVICE IN THIS INFORMATION SHEET AND THE OPERATING CONDITIONS SPECIFIED IN THE PRODUCT DATA SHEET/ CATALOG COULD RESULT IN HAZARDOUS SITUATIONS.**

## 1. MATERIAL CONTENT AND PHYSICAL FORM

Electrical connectors do not usually contain hazardous materials. They contain conducting and non-conducting materials and can be divided into two groups.

a) Printed circuit types and low cost audio types which employ all plastic insulators and casings.

b) Rugged, Fire Barrier and High Reliability types with metal casings and either natural rubber, synthetic rubber, plastic or glass insulating materials. Contact materials vary with type of connector and also application and are usually manufactured from either: Copper, copper alloys, nickel, alumel, chromel or steel. In special applications, other alloys may be specified.

## 2. FIRE CHARACTERISTICS AND ELECTRIC SHOCK HAZARD

**There is no fire hazard when the connector is correctly wired and used within the specified parameters. Incorrect wiring or assembly of the connector or careless use of metal tools or conductive fluids, or transit damage to any of the component parts may cause electric shock or burns. Live circuits must not be broken by separating mated connectors as this may cause arcing, ionization and burning.** Heat dissipation is greater at maximum resistance in a circuit. Hot spots may occur when resistance is raised locally by damage, e.g. cracked or deformed contacts, broken strands of wire. Local overheating may also result from the use of the incorrect application tools or from poor quality soldering or slack screw terminals. Overheating may occur if the ratings in the product Data Sheet/Catalog are exceeded and can cause breakdown of insulation and hence electric shock. If heating is allowed to continue it intensifies by further increasing the local resistance through loss of temper of spring contacts, formation of oxide film on contacts and wires and leakage currents through carbonization of insulation and tracking paths. Fire can then result in the presence of combustible materials and this may release noxious fumes. Overheating may not be visually apparent. Burns may result from touching overheated components.

## 3. HANDLING

Care must be taken to avoid damage to any component parts of electrical connectors during installation and use. Although there are normally no sharp edges, care must be taken when handling certain components to avoid injury to fingers. Electrical connectors may be damaged in transit to the customers, and damage may result in creation of hazards. Products should therefore be examined prior to installation/use and rejected if found to be damaged.

## 4. DISPOSAL

Incineration of certain materials may release noxious or even toxic fumes.

## 5. APPLICATION

Connectors with exposed contacts should not be selected for use on the current supply side of an electrical circuit, because an electric shock could result from touching exposed contacts on an unmated connector. Voltages in excess of 30 V ac or 42.5 V dc are potentially hazardous and care should be taken to ensure that such voltages cannot be transmitted in any way to exposed metal parts of the connector body. The connector and wiring should be checked, before making live, to have no damage to metal parts or insulators, no solder blobs, loose strands, conducting lubricants, swarf, or any other undesired conducting particles. Circuit resistance and continuity check should be made to make certain that there are no high resistance joints or spurious conducting paths. Always use the correct application tools as specified in the Data Sheet/Catalog. Do not permit untrained personnel to wire, assemble or tamper with connectors. For operation voltage please see appropriate national regulations.

## IMPORTANT GENERAL INFORMATION

**(i) Air and creepage paths/Operating voltage.** The admissible operating voltages depend on the individual applications and the valid national and other applicable safety regulations.

For this reason the air and creepage path data are only reference values. Observe reduction of air and creepage paths due to PC board and/or harnessing.

### (ii) Temperature

All information given are temperature limits. The operation temperature depends on the individual application.

### (iii) Other important information

Cannon continuously endeavors to improve their products. Therefore, Cannon products may deviate from the description, technical data and shape as shown in this catalog and data sheets.

“Engineered for life” is a registered trademark of ITT Corporation ©2006. All other trademarks or registered trademarks are property of their respective owners. All data subject to change without notice.

## Product Warranty

ITT Electronic Components, a Division of ITT Corporation manufactures the highest quality products available in the marketplace; however these products are intended to be used in accordance with the specifications in this publication. Any use or application that deviates from the stated operating specifications is not recommended and may be unsafe. No information and data contained in this publication shall be construed to create any liability on the part of Cannon. Any new issue of this publication shall automatically invalidate and supersede any and all previous issues. A limited warranty applies to Cannon products. Except for obligations assumed by Cannon under this warranty, Cannon shall not be liable for any loss, damage, cost of repairs, incidental or consequential damages of any kind, whether or not based on express or implied warranty, contract, negligence or strict liability arising in connection with the design, manufacture, sale, use or repair of the products. Product availability, prices and delivery dates are exclusively subject to our respective order confirmation form; the same applies to orders based on development samples delivered. This publication is not to be construed as an offer. It is intended merely as an invitation to make an offer. By this publication, Cannon does not assume responsibility or any liability for any patent infringements or other rights of third parties which may result from its use. Reprinting this publication is generally permitted, indicating the source. However, Cannon's prior consent must be obtained in all cases.

Dimensions shown in inch (mm)

Specifications and dimensions subject to change

[www.ittcannon.com](http://www.ittcannon.com)





## Rack & Panel Connectors

ITT is the world leader in rack and panel connectors, offering unmatched variety of shell configurations and insert arrangements, materials, plating and contact options. Many of our standard and custom designs meet the stringent requirements of ARINC 600, ARINC 404 (MIL-C-81659), and MIL-DTL-83733 standards.



[www.ittcannon.com/rackandpanel](http://www.ittcannon.com/rackandpanel)

## Circular/Filter/Hermetic Connectors

As a world leader in circular, filter and hermetic connectors, ITT can leverage its design and manufacturing expertise to fit virtually any application. Our expertise includes fast positive mating for a wide range of military applications, as well as numerous sizes and contact configuration for various harsh environments. ITT can also meet numerous specs, including NATO and MIL standards.



[www.ittcannon.com/circulars](http://www.ittcannon.com/circulars) • [www.ittcannon.com/filter](http://www.ittcannon.com/filter) • [www.ittcannon.com/hermetics](http://www.ittcannon.com/hermetics)

## D-Subminiature Connectors

Cannon invented D-sub connectors in 1952. Our family of D-Subs now includes combinations of signal, power and RF, as well as severe service sealed connectors. Cannon D-Subs are available with an extensive line of backshells and accessories and are one of the most economical shielded connector solutions available. Qualified to the MIL-DTL-24308 specification.



[www.ittcannon.com/dsubs](http://www.ittcannon.com/dsubs)

## Fiber Optic Connectors and Cable Assemblies

Cannon fiber optic solutions provide an excellent performance/cost value. Performance can be tailored to the end system, and our use of superior materials and bonding agents provides highly effective solutions. Our wide variety of products includes fiber optic hybrid contacts, multi-channel, rack and panel, and hi-rel assemblies, including MIL and ARINC standard solutions.



[www.ittcannon.com/fiberoptics](http://www.ittcannon.com/fiberoptics)

## Microminiature Connectors

Cannon microminiature connectors offer high performance and reliability with exceptional versatility. Available in rectangular, circular and strip configurations for countless applications, many of our connectors meet or exceed applicable requirements of the MIL-DTL-83513 specification.



[www.ittcannon.com/micro](http://www.ittcannon.com/micro)

ITT's Electronic Components business ([www.ittcannon.com](http://www.ittcannon.com)) is an international supplier of connectors, interconnects, cable assemblies, I/O card kits and smart card systems. As a worldwide leader in connector technology for nearly a century, ITT offers one of the industry's broadest product offerings, manufacturing capability worldwide, fast time to market, high volume/high yield capacity, robust design and Value-Based Product Development and an extensive sales and customer support network.





**ITT**



**ITT**

**Cannon Miniature  
Connectors Customer  
Support Locations**

*ASIA*

Tuopandun Industrial Area, Jinda Cheng,  
Xiner Village, Shajing Town,  
Baoan District, Shenzhen City,  
Guangdong, China 518125  
Phone: (86) 755 2726 7238  
Fax: (86) 755 2726 7515

*GERMANY*

Cannonstrasse 1  
Weinstadt, 71384  
phone: 49.7151.699.0  
fax: 49.7151.699.217

*ITALY*

Corso Europa 41/43  
Lainate (MI),  
Italy 20020  
phone: 39.02938721  
fax: 39.0293872300

*UK*

Jays Close, Viabes Estate  
Basingstoke, RG22 4BA  
phone: 44.1256.311200  
fax: 44.1256.323356

*USA*

666 East Dyer Road  
Santa Ana, CA 92705  
toll free: 1.800.854.3028  
phone: 1.714.557.4700  
fax: 1.714.628.2142

*Engine*

**[www.ittcannon.com](http://www.ittcannon.com)**

©2006 ITT Corporation. "Engineered for life" and "Cannon" are registered trademarks of ITT Corporation. Specification and other data are based on information available at the time of printing, and are subject to change without notice.

CMC-08-06



**Cannon  
Micro  
Conne**

## Looking for pricing, stock, or lifecycle information?

Click below to explore more details on WIN SOURCE:

[View MDM-9PMCBRM7-1-A174 on WIN SOURCE](#)

[ITT Cannon, LLC Information](#)

## Optimize Your Supply Chain with WIN SOURCE Solutions

- ✓ Global Sourcing Solution
- ✓ Obsolete Management
- ✓ Cost Control Management
- ✓ Shortage Management
- ✓ Alternative Solution
- ✓ Excess Inventory Management