



**THE DATASHEET OF  
AT93C56W-10SC-2.5**



## Features

- **Low-voltage and Standard-voltage Operation**
  - 5.0 ( $V_{CC} = 4.5V$  to 5.5V)
  - 2.7 ( $V_{CC} = 2.7V$  to 5.5V)
  - 2.5 ( $V_{CC} = 2.5V$  to 5.5V)
  - 1.8 ( $V_{CC} = 1.8V$  to 5.5V)
- **User-selectable Internal Organization**
  - 1K: 128 x 8 or 64 x 16
  - 2K: 256 x 8 or 128 x 16
  - 4K: 512 x 8 or 256 x 16
- **3-wire Serial Interface**
- **2 MHz Clock Rate (5V) Compatibility**
- **Self-timed Write Cycle (10 ms max)**
- **High Reliability**
  - **Endurance: 1 Million Write Cycles**
  - **Data Retention: 100 Years**
  - **ESD Protection: >4000V**
- **Automotive Grade and Extended Temperature Devices Available**
- **8-pin PDIP, 8-lead JEDEC and EIAJ SOIC, and 8-lead TSSOP Packages**

## Description

The AT93C46/56/57/66 provides 1024/2048/4096 bits of serial electrically erasable programmable read only memory (EEPROM) organized as 64/128/256 words of 16 bits each, when the ORG pin is connected to  $V_{CC}$  and 128/256/512 words of 8 bits each when it is tied to ground. The device is optimized for use in many industrial and commercial applications where low power and low voltage operations are essential. The AT93C46/56/57/66 is available in space saving 8-pin PDIP and 8-lead JEDEC and EIAJ SOIC packages.

*(continued)*

## Pin Configurations

Pin Name	Function
CS	Chip Select
SK	Serial Data Clock
DI	Serial Data Input
DO	Serial Data Output
GND	Ground
VCC	Power Supply
ORG	Internal Organization
DC	Don't Connect

8-pin PDIP

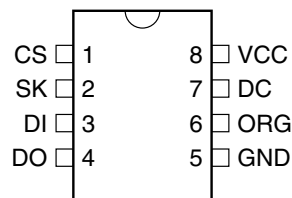

8-lead SOIC

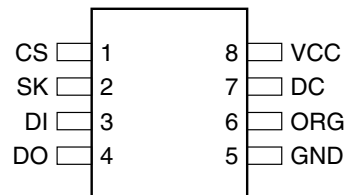

8-lead SOIC  
Rotated (R)  
(1K JEDEC Only)

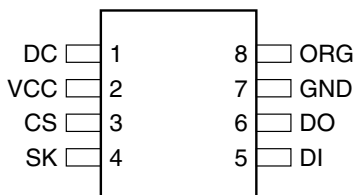

8-lead TSSOP

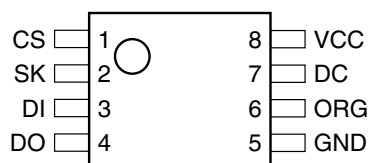

## 3-wire Serial EEPROMs

1K (128 x 8 or 64 x 16)

2K (256 x 8 or 128 x 16)

4K (512 x 8 or 256 x 16)

**AT93C46**

**AT93C56**

**AT93C57**

**AT93C66**



The AT93C46/56/57/66 is enabled through the Chip Select pin (CS), and accessed via a 3-wire serial interface consisting of Data Input (DI), Data Output (DO), and Shift Clock (SK). Upon receiving a READ instruction at DI, the address is decoded and the data is clocked out serially on the data output pin DO. The WRITE cycle is completely self-timed and no separate ERASE cycle is required before WRITE. The WRITE cycle is only enabled when the part is in the

ERASE/WRITE ENABLE state. When CS is brought “high” following the initiation of a WRITE cycle, the DO pin outputs the READY/BUSY status of the part.

The AT93C46 is available in 4.5V to 5.5V, 2.7V to 5.5V, 2.5V to 5.5V, and 1.8V to 5.5V versions. The AT93C56/57/66 is available in 4.5V to 5.5V, 2.7V to 5.5V, and 2.5V to 5.5V versions.

### Absolute Maximum Ratings\*

Operating Temperature.....	-55°C to +125°C
Storage Temperature .....	-65°C to +150°C
Voltage on Any Pin with Respect to Ground .....	-1.0V to +7.0V
Maximum Operating Voltage .....	6.25V
DC Output Current.....	5.0 mA

\*NOTICE: Stresses beyond those listed under “Absolute Maximum Ratings” may cause permanent damage to the device. This is a stress rating only and functional operation of the device at these or any other conditions beyond those indicated in the operational sections of this specification is not implied. Exposure to absolute maximum rating conditions for extended periods may affect device reliability

### Block Diagram



Note: 1. When the ORG pin is connected to  $V_{CC}$ , the x 16 organization is selected. When it is connected to ground, the x 8 organization is selected. If the ORG pin is left unconnected, then an internal pullup device (of approximately 1 M $\Omega$ ) will select the x 16 organization. This feature is not available on 1.8V devices.

## Pin Capacitance<sup>(1)</sup>

Applicable over recommended operating range from  $T_A = 25^\circ\text{C}$ ,  $f = 1.0\text{ MHz}$ ,  $V_{CC} = +5.0\text{V}$  (unless otherwise noted).

Symbol	Test Conditions	Max	Units	Conditions
$C_{OUT}$	Output Capacitance (DO)	5	pF	$V_{OUT} = 0\text{V}$
$C_{IN}$	Input Capacitance (CS, SK, DI)	5	pF	$V_{IN} = 0\text{V}$

Note: 1. This parameter is characterized and is not 100% tested.

## DC Characteristics

Applicable over recommended operating range from:  $T_{AI} = -40^\circ\text{C}$  to  $+85^\circ\text{C}$ ,  $V_{CC} = +1.8\text{V}$  to  $+5.5\text{V}$ ,  $T_{AC} = 0^\circ\text{C}$  to  $+70^\circ\text{C}$ ,  $V_{CC} = +1.8\text{V}$  to  $+5.5\text{V}$  (unless otherwise noted).

Symbol	Parameter	Test Condition	Min	Typ	Max	Unit	
$V_{CC1}$	Supply Voltage		1.8		5.5	V	
$V_{CC2}$	Supply Voltage		2.5		5.5	V	
$V_{CC3}$	Supply Voltage		2.7		5.5	V	
$V_{CC4}$	Supply Voltage		4.5		5.5	V	
$I_{CC}$	Supply Current	$V_{CC} = 5.0\text{V}$	READ at 1.0 MHz		0.5	2.0	mA
			WRITE at 1.0 MHz		0.5	2.0	mA
$I_{SB1}$	Standby Current	$V_{CC} = 1.8\text{V}$	CS = 0V		0	0.1	$\mu\text{A}$
$I_{SB2}$	Standby Current	$V_{CC} = 2.5\text{V}$	CS = 0V		6.0	10.0	$\mu\text{A}$
$I_{SB3}$	Standby Current	$V_{CC} = 2.7\text{V}$	CS = 0V		6.0	10.0	$\mu\text{A}$
$I_{SB4}$	Standby Current	$V_{CC} = 5.0\text{V}$	CS = 0V		17	30	$\mu\text{A}$
$I_{IL}$	Input Leakage	$V_{IN} = 0\text{V}$ to $V_{CC}$			0.1	1.0	$\mu\text{A}$
$I_{OL}$	Output Leakage	$V_{IN} = 0\text{V}$ to $V_{CC}$			0.1	1.0	$\mu\text{A}$
$V_{IL1}^{(1)}$ $V_{IH1}^{(1)}$	Input Low Voltage Input High Voltage	$4.5\text{V} \leq V_{CC} \leq 5.5\text{V}$		-0.6 2.0		0.8 $V_{CC} + 1$	V
$V_{IL2}^{(1)}$ $V_{IH2}^{(1)}$	Input Low Voltage Input High Voltage	$1.8\text{V} \leq V_{CC} \leq 2.7\text{V}$		-0.6 $V_{CC} \times 0.7$		$V_{CC} \times 0.3$ $V_{CC} + 1$	V
$V_{OL1}$ $V_{OH1}$	Output Low Voltage Output High Voltage	$4.5\text{V} \leq V_{CC} \leq 5.5\text{V}$	$I_{OL} = 2.1\text{ mA}$			0.4	V
			$I_{OH} = -0.4\text{ mA}$	2.4			V
$V_{OL2}$ $V_{OH2}$	Output Low Voltage Output High Voltage	$1.8\text{V} \leq V_{CC} \leq 2.7\text{V}$	$I_{OL} = 0.15\text{ mA}$			0.2	V
			$I_{OH} = -100\text{ }\mu\text{A}$	$V_{CC} - 0.2$			V

Note: 1.  $V_{IL}$  min and  $V_{IH}$  max are reference only and are not tested.



## AC Characteristics

Applicable over recommended operating range from  $T_A = -40^{\circ}\text{C}$  to  $+85^{\circ}\text{C}$ ,  $V_{CC} = \text{As Specified}$ ,  
 $CL = 1$  TTL Gate and  $100\text{ pF}$  (unless otherwise noted).

Symbol	Parameter	Test Condition	Min	Typ	Max	Units
$f_{SK}$	SK Clock Frequency	$4.5\text{V} \leq V_{CC} \leq 5.5\text{V}$	0		2	MHz
		$2.7\text{V} \leq V_{CC} \leq 5.5\text{V}$	0		1	
		$2.5\text{V} \leq V_{CC} \leq 5.5\text{V}$	0		0.5	
		$1.8\text{V} \leq V_{CC} \leq 5.5\text{V}$	0		0.25	
$t_{SKH}$	SK High Time	$4.5\text{V} \leq V_{CC} \leq 5.5\text{V}$	250			ns
		$2.7\text{V} \leq V_{CC} \leq 5.5\text{V}$	250			
		$2.5\text{V} \leq V_{CC} \leq 5.5\text{V}$	500			
		$1.8\text{V} \leq V_{CC} \leq 5.5\text{V}$	1000			
$t_{SKL}$	SK Low Time	$4.5\text{V} \leq V_{CC} \leq 5.5\text{V}$	250			ns
		$2.7\text{V} \leq V_{CC} \leq 5.5\text{V}$	250			
		$2.5\text{V} \leq V_{CC} \leq 5.5\text{V}$	500			
		$1.8\text{V} \leq V_{CC} \leq 5.5\text{V}$	1000			
$t_{CS}$	Minimum CS Low Time	$4.5\text{V} \leq V_{CC} \leq 5.5\text{V}$	250			ns
		$2.7\text{V} \leq V_{CC} \leq 5.5\text{V}$	250			
		$2.5\text{V} \leq V_{CC} \leq 5.5\text{V}$	500			
		$1.8\text{V} \leq V_{CC} \leq 5.5\text{V}$	1000			
$t_{CSS}$	CS Setup Time	Relative to SK	$4.5\text{V} \leq V_{CC} \leq 5.5\text{V}$	50		ns
			$2.7\text{V} \leq V_{CC} \leq 5.5\text{V}$	50		
			$2.5\text{V} \leq V_{CC} \leq 5.5\text{V}$	100		
			$1.8\text{V} \leq V_{CC} \leq 5.5\text{V}$	200		
$t_{DIS}$	DI Setup Time	Relative to SK	$4.5\text{V} \leq V_{CC} \leq 5.5\text{V}$	100		ns
			$2.7\text{V} \leq V_{CC} \leq 5.5\text{V}$	100		
			$2.5\text{V} \leq V_{CC} \leq 5.5\text{V}$	200		
			$1.8\text{V} \leq V_{CC} \leq 5.5\text{V}$	400		
$t_{CSH}$	CS Hold Time	Relative to SK		0		ns
$t_{DIH}$	DI Hold Time	Relative to SK	$4.5\text{V} \leq V_{CC} \leq 5.5\text{V}$	100		ns
			$2.7\text{V} \leq V_{CC} \leq 5.5\text{V}$	100		
			$2.5\text{V} \leq V_{CC} \leq 5.5\text{V}$	200		
			$1.8\text{V} \leq V_{CC} \leq 5.5\text{V}$	400		
$t_{PD1}$	Output Delay to '1'	AC Test	$4.5\text{V} \leq V_{CC} \leq 5.5\text{V}$		250	ns
			$2.7\text{V} \leq V_{CC} \leq 5.5\text{V}$		250	
			$2.5\text{V} \leq V_{CC} \leq 5.5\text{V}$		500	
			$1.8\text{V} \leq V_{CC} \leq 5.5\text{V}$		1000	
$t_{PD0}$	Output Delay to '0'	AC Test	$4.5\text{V} \leq V_{CC} \leq 5.5\text{V}$		250	ns
			$2.7\text{V} \leq V_{CC} \leq 5.5\text{V}$		250	
			$2.5\text{V} \leq V_{CC} \leq 5.5\text{V}$		500	
			$1.8\text{V} \leq V_{CC} \leq 5.5\text{V}$		1000	
$t_{SV}$	CS to Status Valid	AC Test	$4.5\text{V} \leq V_{CC} \leq 5.5\text{V}$		250	ns
			$2.7\text{V} \leq V_{CC} \leq 5.5\text{V}$		250	
			$2.5\text{V} \leq V_{CC} \leq 5.5\text{V}$		500	
			$1.8\text{V} \leq V_{CC} \leq 5.5\text{V}$		1000	
$t_{DF}$	CS to DO in High Impedance	AC Test CS = $V_{IL}$	$4.5\text{V} \leq V_{CC} \leq 5.5\text{V}$		100	ns
			$2.7\text{V} \leq V_{CC} \leq 5.5\text{V}$		100	
			$2.5\text{V} \leq V_{CC} \leq 5.5\text{V}$		200	
			$1.8\text{V} \leq V_{CC} \leq 5.5\text{V}$		400	
$t_{WP}$	Write Cycle Time		0.1		10	ms
		$4.5\text{V} \leq V_{CC} \leq 5.5\text{V}$		1		ms
Endurance <sup>(1)</sup>	5.0V, 25°C, Page Mode		1M			Write Cycles

Note: 1. This parameter is characterized and is not 100% tested.

**Instruction Set for the AT93C46**

Instruction	SB	Op Code	Address		Data		Comments
			x 8	x 16	x 8	x 16	
READ	1	10	A <sub>6</sub> - A <sub>0</sub>	A <sub>5</sub> - A <sub>0</sub>			Reads data stored in memory, at specified address.
EWEN	1	00	11XXXXXX	11XXXX			Write enable must precede all programming modes.
ERASE	1	11	A <sub>6</sub> - A <sub>0</sub>	A <sub>5</sub> - A <sub>0</sub>			Erase memory location A <sub>n</sub> - A <sub>0</sub> .
WRITE	1	01	A <sub>6</sub> - A <sub>0</sub>	A <sub>5</sub> - A <sub>0</sub>	D <sub>7</sub> - D <sub>0</sub>	D <sub>15</sub> - D <sub>0</sub>	Writes memory location A <sub>n</sub> - A <sub>0</sub> .
ERAL	1	00	10XXXXXX	10XXXX			Erases all memory locations. Valid only at V <sub>CC</sub> = 4.5V to 5.5V.
WRAL	1	00	01XXXXXX	01XXXX	D <sub>7</sub> - D <sub>0</sub>	D <sub>15</sub> - D <sub>0</sub>	Writes all memory locations. Valid only at V <sub>CC</sub> = 4.5V to 5.5V.
EWDS	1	00	00XXXXXX	00XXXX			Disables all programming instructions.

**Instruction Set for the AT93C57**

Instruction	SB	Op Code	Address		Data		Comments
			x 8	x 16	x 8	x 16	
READ	1	10	A <sub>7</sub> - A <sub>0</sub>	A <sub>6</sub> - A <sub>0</sub>			Reads data stored in memory, at specified address.
EWEN	1	00	11XXXXXXX	11XXXXXX			Write enable must precede all programming modes.
ERASE	1	11	A <sub>7</sub> - A <sub>0</sub>	A <sub>6</sub> - A <sub>0</sub>			Erase memory location A <sub>n</sub> - A <sub>0</sub> .
WRITE	1	01	A <sub>7</sub> - A <sub>0</sub>	A <sub>6</sub> - A <sub>0</sub>	D <sub>7</sub> - D <sub>0</sub>	D <sub>15</sub> - D <sub>0</sub>	Writes memory location A <sub>n</sub> - A <sub>0</sub> .
ERAL	1	00	10XXXXXXX	10XXXXXX			Erases all memory locations. Valid only at V <sub>CC</sub> = 4.5V to 5.5V.
WRAL	1	00	01XXXXXXX	01XXXXXX	D <sub>7</sub> - D <sub>0</sub>	D <sub>15</sub> - D <sub>0</sub>	Writes all memory locations. Valid only at V <sub>CC</sub> = 4.5V to 5.5V.
EWDS	1	00	00XXXXXXX	00XXXXXX			Disables all programming instructions.

## Instruction Set for the AT93C56 and AT93C66

Instruction	SB	Op Code	Address		Data		Comments
			x 8	x 16	x 8	x 16	
READ	1	10	A <sub>8</sub> - A <sub>0</sub>	A <sub>7</sub> - A <sub>0</sub>			Reads data stored in memory, at specified address.
EWEN	1	00	11XXXXXXXX	11XXXXXX			Write enable must precede all programming modes.
ERASE	1	11	A <sub>8</sub> - A <sub>0</sub>	A <sub>7</sub> - A <sub>0</sub>			Erases memory location A <sub>n</sub> - A <sub>0</sub> .
WRITE	1	01	A <sub>8</sub> - A <sub>0</sub>	A <sub>7</sub> - A <sub>0</sub>	D <sub>7</sub> - D <sub>0</sub>	D <sub>15</sub> - D <sub>0</sub>	Writes memory location A <sub>n</sub> - A <sub>0</sub> .
ERAL	1	00	10XXXXXXXX	10XXXXXX			Erases all memory locations. Valid only at V <sub>CC</sub> = 4.5V to 5.5V.
WRAL	1	00	01XXXXXXXX	01XXXXXX	D <sub>7</sub> - D <sub>0</sub>	D <sub>15</sub> - D <sub>0</sub>	Writes all memory locations. Valid when V <sub>CC</sub> = 5.0V ± 10% and Disable Register cleared.
EWDS	1	00	00XXXXXXXX	00XXXXXX			Disables all programming instructions.

### Functional Description

The AT93C46/56/57/66 is accessed via a simple and versatile 3-wire serial communication interface. Device operation is controlled by seven instructions issued by the host processor. **A valid instruction starts with a rising edge of CS** and consists of a Start Bit (logic “1”) followed by the appropriate Op Code and the desired memory Address location.

**READ (READ):** The Read (READ) instruction contains the Address code for the memory location to be read. After the instruction and address are decoded, data from the selected memory location is available at the serial output pin DO. Output data changes are synchronized with the rising edges of serial clock SK. It should be noted that a dummy bit (logic “0”) precedes the 8- or 16-bit data output string.

**ERASE/WRITE (EWEN):** To assure data integrity, the part automatically goes into the Erase/Write Disable (EWDS) state when power is first applied. An Erase/Write Enable (EWEN) instruction must be executed first before any programming instructions can be carried out. Please note that once in the Erase/Write Enable state, programming remains enabled until an Erase/Write Disable (EWDS) instruction is executed or V<sub>CC</sub> power is removed from the part.

**ERASE (ERASE):** The Erase (ERASE) instruction programs all bits in the specified memory location to the logical “1” state. The self-timed erase cycle starts once the ERASE instruction and address are decoded. The DO pin outputs the READY/BUSY status of the part if CS is brought high after being kept low for a minimum of 250 ns (t<sub>CS</sub>). A logic “1” at pin DO indicates that the selected memory location has been erased, and the part is ready for another instruction.

**WRITE (WRITE):** The Write (WRITE) instruction contains the 8 or 16 bits of data to be written into the specified memory location. The self-timed programming cycle, t<sub>WP</sub>, starts after the last bit of data is received at serial data input pin DI. The DO pin outputs the READY/BUSY status of the part if CS is brought high after being kept low for a minimum of 250 ns (t<sub>CS</sub>). A logic “0” at DO indicates that programming is still in progress. A logic “1” indicates that the memory location at the specified address has been written with the data pattern contained in the instruction and the part is ready for further instructions. **A READY/BUSY status cannot be obtained if the CS is brought high after the end of the self-timed programming cycle, t<sub>WP</sub>.**

**ERASE ALL (ERAL):** The Erase All (ERAL) instruction programs every bit in the memory array to the logic “1” state and is primarily used for testing purposes. The DO pin outputs the READY/BUSY status of the part if CS is brought high after being kept low for a minimum of 250 ns (t<sub>CS</sub>). The ERAL instruction is valid only at V<sub>CC</sub> = 5.0V ± 10%.

**WRITE ALL (WRAL):** The Write All (WRAL) instruction programs all memory locations with the data patterns specified in the instruction. The DO pin outputs the READY/BUSY status of the part if CS is brought high after being kept low for a minimum of 250 ns (t<sub>CS</sub>). The WRAL instruction is valid only at V<sub>CC</sub> = 5.0V ± 10%.

**ERASE/WRITE DISABLE (EWDS):** To protect against accidental data disturb, the Erase/Write Disable (EWDS) instruction disables all programming modes and should be executed after all programming operations. The operation of the READ instruction is independent of both the EWEN and EWDS instructions and can be executed at any time.

## Timing Diagrams

### Synchronous Data Timing



Note: 1. This is the minimum SK period.

### Organization Key for Timing Diagrams

I/O	AT93C46 (1K)		AT93C56 (2K)		AT93C57 (2K)		AT93C66 (4K)	
	x 8	x 16	x 8	x 16	x 8	x 16	x 8	x 16
$A_N$	$A_6$	$A_5$	$A_8^{(1)}$	$A_7^{(2)}$	$A_7$	$A_6$	$A_8$	$A_7$
$D_N$	$D_7$	$D_{15}$	$D_7$	$D_{15}$	$D_7$	$D_{15}$	$D_7$	$D_{15}$

Note: 1.  $A_8$  is a DON'T CARE value, but the extra clock is required.

2.  $A_7$  is a DON'T CARE value, but the extra clock is required.

### READ Timing



### EWEN Timing



### EWDS Timing



### WRITE Timing



### WRAL Timing<sup>(1)</sup>



Note: 1. Valid only at  $V_{CC} = 4.5V$  to  $5.5V$ .

**ERASE Timing**

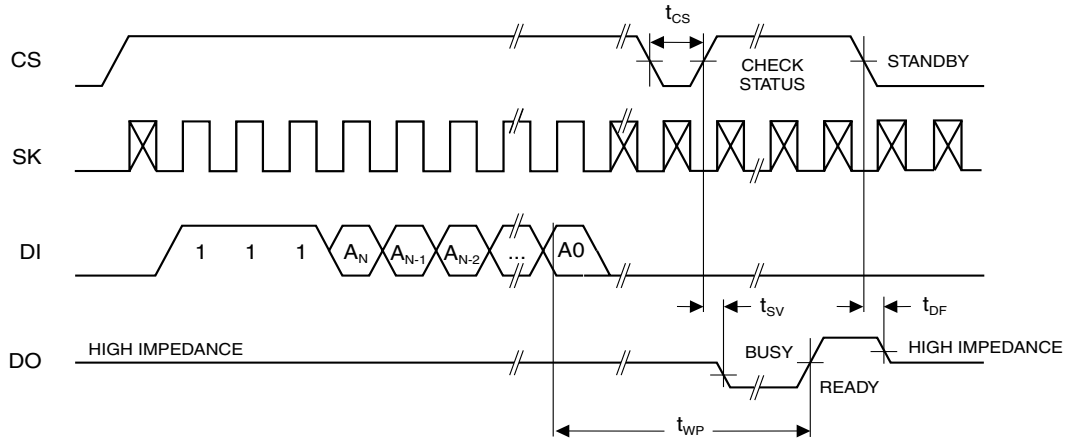

**TERAL Timing<sup>(1)</sup>**

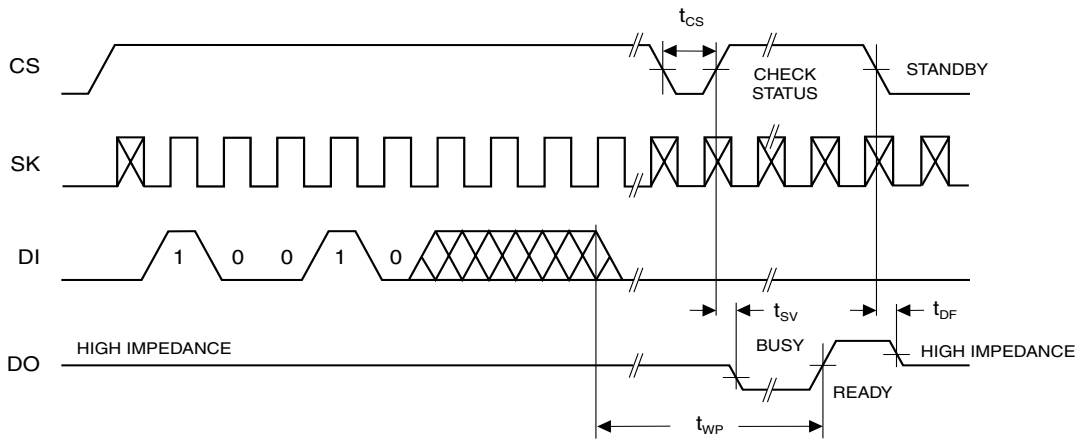

Note: 1. Valid only at  $V_{CC} = 4.5V$  to  $5.5V$ .



## AT93C46 Ordering Information

$t_{WP}$ (max) (ms)	$I_{CC}$ (max) ( $\mu$ A)	$I_{SB}$ (max) ( $\mu$ A)	$f_{MAX}$ (kHz)	Ordering Code	Package	Operation Range
10	2000	30.0	2000	AT93C46-10PC AT93C46-10SC AT93C46R-10SC AT93C46W-10SC AT93C46-10TC	8P3 8S1 8S1 8S2 8T	Commercial (0°C to 70°C)
		30.0	2000	AT93C46-10PI AT93C46-10SI AT93C46R-10SI AT93C46W-10SI AT93C46-10TI	8P3 8S1 8S1 8S2 8T	Industrial (-40°C to 85°C)
10	800	10.0	1000	AT93C46-10PC-2.7 AT93C46-10SC-2.7 AT93C46R-10SC-2.7 AT93C46W-10SC-2.7 AT93C46-10TC-2.7	8P3 8S1 8S1 8S2 8T	Commercial (0°C to 70°C)
		10.0	1000	AT93C46-10PI-2.7 AT93C46-10SI-2.7 AT93C46R-10SI-2.7 AT93C46W-10SI-2.7 AT93C46-10TI-2.7	8P3 8S1 8S1 8S2 8T	Industrial (-40°C to 85°C)

Package Type	
<b>8P3</b>	8-pin, 0.300" Wide, Plastic Dual Inline Package (PDIP)
<b>8S1</b>	8-lead, 0.150" Wide, Plastic Gull Wing Small Outline (JEDEC SOIC)
<b>8S2</b>	8-lead, 0.200" Wide, Plastic Gull Wing Small Outline (EIAJ SOIC)
<b>8T</b>	8-lead, 0.170" Wide, Thin Shrink Small Outline Package (TSSOP)
Options	
<b>Blank</b>	Standard Operation (4.5V to 5.5V)
<b>-2.7</b>	Low Voltage (2.7V to 5.5V)
<b>-2.5</b>	Low Voltage (2.5V to 5.5V)
<b>R</b>	Rotated Pinout

**AT93C46 Ordering Information (Continued)**

<b>t<sub>WP</sub> (max)</b> <b>(ms)</b>	<b>I<sub>CC</sub> (max)</b> <b>(μA)</b>	<b>I<sub>SB</sub> (max)</b> <b>(μA)</b>	<b>f<sub>MAX</sub></b> <b>(kHz)</b>	<b>Ordering Code</b>	<b>Package</b>	<b>Operation Range</b>
10	600	10.0	500	AT93C46-10PC-2.5 AT93C46-10SC-2.5 AT93C46R-10SC-2.5 AT93C46W-10SC-2.5 AT93C46-10TC-2.5	8P3 8S1 8S1 8S2 8T	Commercial (0°C to 70°C)
		10.0	500	AT93C46-10PI-2.5 AT93C46-10SI-2.5 AT93C46R-10SI-2.5 AT93C46W-10SI-2.5 AT93C46-10TI-2.5	8P3 8S1 8S1 8S2 8T	Industrial (-40°C to 85°C)
10	80	0.1	250	AT93C46-10PC-1.8 AT93C46-10SC-1.8 AT93C46R-10SC-1.8 AT93C46W-10SC-1.8 AT93C46-10TC-1.8	8P3 8S1 8S1 8S2 8T	Commercial (0°C to 70°C)
		0.1	250	AT93C46-10PI-1.8 AT93C46-10SI-1.8 AT93C46R-10SI-1.8 AT93C46W-10SI-1.8 AT93C46-10TI-1.8	8P3 8S1 8S1 8S2 8T	Industrial (-40°C to 85°C)

<b>Package Type</b>	
<b>8P3</b>	8-pin, 0.300" Wide, Plastic Dual Inline Package (PDIP)
<b>8S1</b>	8-lead, 0.150" Wide, Plastic Gull Wing Small Outline (JEDEC SOIC)
<b>8S2</b>	8-lead, 0.200" Wide, Plastic Gull Wing Small Outline (EIAJ SOIC)
<b>8T</b>	8-lead, 0.170" Wide, Thin Shrink Small Outline Package (TSSOP)
<b>Options</b>	
<b>Blank</b>	Standard Operation (4.5V to 5.5V)
<b>-2.7</b>	Low Voltage (2.7V to 5.5V)
<b>-2.5</b>	Low Voltage (2.5V to 5.5V)
<b>-1.8</b>	Low Voltage (1.8V to 5.5V)
<b>R</b>	Rotated Pinout





## AT93C56 Ordering Information

$t_{WP}$ (max) (ms)	$I_{CC}$ (max) ( $\mu A$ )	$I_{SB}$ (max) ( $\mu A$ )	$f_{MAX}$ (kHz)	Ordering Code	Package	Operation Range
10	2000	30.0	2000	AT93C56-10PC AT93C56-10SC AT93C56W-10SC	8P3 8S1 8S2	Commercial (0°C to 70°C)
		30.0	2000	AT93C56-10PI AT93C56-10SI AT93C56W-10SI	8P3 8S1 8S2	Industrial (-40°C to 85°C)
10	800	10.0	1000	AT93C56-10PC-2.7 AT93C56-10SC-2.7 AT93C56W-10SC-2.7	8P3 8S1 8S2	Commercial (0°C to 70°C)
		10.0	1000	AT93C56-10PI-2.7 AT93C56-10SI-2.7 AT93C56W-10SI-2.7	8P3 8S1 8S2	Industrial (-40°C to 85°C)
10	600	10.0	500	AT93C56-10PC-2.5 AT93C56-10SC-2.5 AT93C56W-10SC-2.5	8P3 8S1 8S2	Commercial (0°C to 70°C)
		10.0	500	AT93C56-10PI-2.5 AT93C56-10SI-2.5 AT93C56W-10SI-2.5	8P3 8S1 8S2	Industrial (-40°C to 85°C)

Package Type	
<b>8P3</b>	8-pin, 0.300" Wide, Plastic Dual Inline Package (PDIP)
<b>8S1</b>	8-lead, 0.150" Wide, Plastic Gull Wing Small Outline (JEDEC SOIC)
<b>8S2</b>	8-lead, 0.200" Wide, Plastic Gull Wing Small Outline (EIAJ SOIC)
Options	
<b>Blank</b>	Standard Operation (4.5V to 5.5V)
<b>-2.7</b>	Low Voltage (2.7V to 5.5V)
<b>-2.5</b>	Low Voltage (2.5V to 5.5V)

**AT93C57 Ordering Information**

<b>t<sub>WP</sub> (max)</b> <b>(ms)</b>	<b>I<sub>CC</sub> (max)</b> <b>(μA)</b>	<b>I<sub>SB</sub> (max)</b> <b>(μA)</b>	<b>f<sub>MAX</sub></b> <b>(kHz)</b>	<b>Ordering Code</b>	<b>Package</b>	<b>Operation Range</b>
10	2000	30.0	2000	AT93C57-10PC AT93C57-10SC AT93C57W-10SC	8P3 8S1 8S2	Commercial (0°C to 70°C)
		30.0	2000	AT93C57-10PI AT93C57-10SI AT93C57W-10SI	8P3 8S1 8S2	Industrial (-40°C to 85°C)
10	800	10.0	1000	AT93C57-10PC-2.7 AT93C57-10SC-2.7 AT93C57W-10SC-2.7	8P3 8S1 8S2	Commercial (0°C to 70°C)
		10.0	1000	AT93C57-10PI-2.7 AT93C57-10SI-2.7 AT93C57W-10SI-2.7	8P3 8S1 8S2	Industrial (-40°C to 85°C)

<b>Package Type</b>	
<b>8P3</b>	8-pin, 0.300" Wide, Plastic Dual Inline Package (PDIP)
<b>8S1</b>	8-lead, 0.150" Wide, Plastic Gull Wing Small Outline (JEDEC SOIC)
<b>8S2</b>	8-lead, 0.200" Wide, Plastic Gull Wing Small Outline (EIAJ SOIC)
<b>Options</b>	
<b>Blank</b>	Standard Operation (4.5V to 5.5V)
<b>-2.7</b>	Low Voltage (2.7V to 5.5V)
<b>-2.5</b>	Low Voltage (2.5V to 5.5V)





## AT93C66 Ordering Information

$t_{WP}$ (max) (ms)	$I_{CC}$ (max) ( $\mu$ A)	$I_{SB}$ (max) ( $\mu$ A)	$f_{MAX}$ (kHz)	Ordering Code	Package	Operation Range
10	2000	30.0	2000	AT93C66-10PC AT93C66-10SC AT93C66W-10SC AT93C66-10TC	8P3 8S1 8S2 8T	Commercial (0°C to 70°C)
		30.0	2000	AT93C66-10PI AT93C66-10SI AT93C66W-10SI AT93C66-10TI	8P3 8S1 8S2 8T	Industrial (-40°C to 85°C)
10	800	10.0	1000	AT93C66-10PC-2.7 AT93C66-10SC-2.7 AT93C66W-10SC-2.7 AT93C66-10TC-2.7	8P3 8S1 8S2 8T	Commercial (0°C to 70°C)
		10.0	1000	AT93C66-10PI-2.7 AT93C66-10SI-2.7 AT93C66W-10SI-2.7 AT93C66-10TI-2.7	8P3 8S1 8S2 8T	Industrial (-40°C to 85°C)
10	600	10.0	500	AT93C66-10PC-2.5 AT93C66-10SC-2.5 AT93C66W-10SC-2.5 AT93C66-10TC-2.5	8P3 8S1 8S2 8T	Commercial (0°C to 70°C)
		10.0	500	AT93C66-10PI-2.5 AT93C66-10SI-2.5 AT93C66W-10SI-2.5 AT93C66-10TI-2.5	8P3 8S1 8S2 8T	Industrial (-40°C to 85°C)

Package Type	
<b>8P3</b>	8-pin, 0.300" Wide, Plastic Dual Inline Package (PDIP)
<b>8S1</b>	8-lead, 0.150" Wide, Plastic Gull Wing Small Outline (JEDEC SOIC)
<b>8S2</b>	8-lead, 0.200" Wide, Plastic Gull Wing Small Outline (EIAJ SOIC)
<b>8T</b>	8-lead, 0.170" Wide, Thin Shrink Small Outline Package (TSSOP)
Options	
<b>Blank</b>	Standard Operation (4.5V to 5.5V)
<b>-2.7</b>	Low Voltage (2.7V to 5.5V)
<b>-2.5</b>	Low Voltage (2.5V to 5.5V)

Packaging Information

**8P3**, 8-pin, 0.300" Wide,  
Plastic Dual Inline Package (PDIP)  
Dimensions in Inches and (Millimeters)  
JEDEC STANDARD MS-001 BA



**8S1**, 8-lead, 0.150" Wide,  
Plastic Gull Wing Small Outline (JEDEC SOIC)  
Dimensions in Inches and (Millimeters)



**8S2**, 8-lead, 0.200" Wide,  
Plastic Gull Wing Small Outline (EIAJ SOIC)  
Dimensions in Inches and (Millimeters)

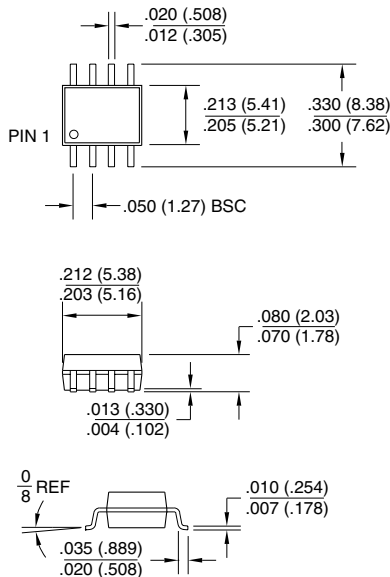

**8T**, 8-lead, 0.170" Wide,  
Thin Shrink Small Outline Package (TSSOP)  
Dimensions in Millimeters and (Inches)\*



\*Controlling dimension: millimeters



## Atmel Headquarters

### *Corporate Headquarters*

2325 Orchard Parkway  
San Jose, CA 95131  
TEL (408) 441-0311  
FAX (408) 487-2600

### *Europe*

Atmel U.K., Ltd.  
Coliseum Business Centre  
Riverside Way  
Camberley, Surrey GU15 3YL  
England  
TEL (44) 1276-686-677  
FAX (44) 1276-686-697

### *Asia*

Atmel Asia, Ltd.  
Room 1219  
Chinachem Golden Plaza  
77 Mody Road Tsimhatsui  
East Kowloon  
Hong Kong  
TEL (852) 2721-9778  
FAX (852) 2722-1369

### *Japan*

Atmel Japan K.K.  
9F, Tonetsu Shinkawa Bldg.  
1-24-8 Shinkawa  
Chuo-ku, Tokyo 104-0033  
Japan  
TEL (81) 3-3523-3551  
FAX (81) 3-3523-7581

## Atmel Operations

### *Atmel Colorado Springs*

1150 E. Cheyenne Mtn. Blvd.  
Colorado Springs, CO 80906  
TEL (719) 576-3300  
FAX (719) 540-1759

### *Atmel Rousset*

Zone Industrielle  
13106 Rousset Cedex  
France  
TEL (33) 4-4253-6000  
FAX (33) 4-4253-6001

---

### *Fax-on-Demand*

North America:  
1-(800) 292-8635  
International:  
1-(408) 441-0732

### *e-mail*

[literature@atmel.com](mailto:literature@atmel.com)

### *Web Site*

<http://www.atmel.com>

### *BBS*

1-(408) 436-4309

### © Atmel Corporation 1999.

Atmel Corporation makes no warranty for the use of its products, other than those expressly contained in the Company's standard warranty which is detailed in Atmel's Terms and Conditions located on the Company's web site. The Company assumes no responsibility for any errors which may appear in this document, reserves the right to change devices or specifications detailed herein at any time without notice, and does not make any commitment to update the information contained herein. No licenses to patents or other intellectual property of Atmel are granted by the Company in connection with the sale of Atmel products, expressly or by implication. Atmel's products are not authorized for use as critical components in life support devices or systems.

Marks bearing ® and/or ™ are registered trademarks and trademarks of Atmel Corporation.

Terms and product names in this document may be trademarks of others.



Printed on recycled paper.

0172L-10/99/xM

## Looking for pricing, stock, or lifecycle information?

Click below to explore more details on WIN SOURCE:

 [View AT93C56W-10SC-2.5 on WIN SOURCE](#)

 [Atmel Information](#)

## Optimize Your Supply Chain with WIN SOURCE Solutions

-  Global Sourcing Solution
-  Obsolete Management
-  Cost Control Management
-  Shortage Management
-  Alternative Solution
-  Excess Inventory Management