



**THE DATASHEET OF
MC74HCT366ADTG**



MC74HCT366A

Hex 3-State Inverting Buffer with Common Enables and LSTTL Compatible Inputs

High-Performance Silicon-Gate CMOS

The MC74HCT366A is identical in pinout to the LS366. The device inputs are compatible with standard CMOS or LSTTL outputs.

This device is a high-speed hex buffer with 3-state outputs and two common active-low Output Enables. When either of the enables is high, the buffer outputs are placed into high-impedance states. The HCT366A has inverting outputs.

Features

- Output Drive Capability: 15 LSTTL Loads
- Outputs Directly Interface to CMOS, NMOS, and TTL
- Operating Voltage Range: 2.0 to 6.0 V
- Low Input Current: 1.0 μ A
- High Noise Immunity Characteristic of CMOS Devices
- In Compliance with the Requirements Defined by JEDEC Standard No. 7A
- Chip Complexity: 90 FETs or 22.5 Equivalent Gates
- NLV Prefix for Automotive and Other Applications Requiring Unique Site and Control Change Requirements; AEC-Q100 Qualified and PPAP Capable
- These are Pb-Free Devices*



ON Semiconductor®

<http://onsemi.com>

MARKING DIAGRAMS

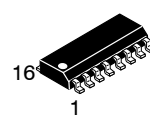

SOIC-16
D SUFFIX
CASE 751B

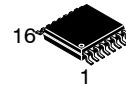
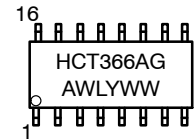

TSSOP-16
DT SUFFIX
CASE 948F

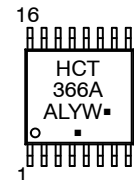

A = Assembly Location
WL, L = Wafer Lot
Y = Year
WW, W = Work Week
G or ■ = Pb-Free Package
(Note: Microdot may be in either location)

ORDERING INFORMATION

See detailed ordering and shipping information in the package dimensions section on page 2 of this data sheet.

*For additional information on our Pb-Free strategy and soldering details, please download the ON Semiconductor Soldering and Mounting Techniques Reference Manual, SOLDERRM/D.

MC74HCT366A

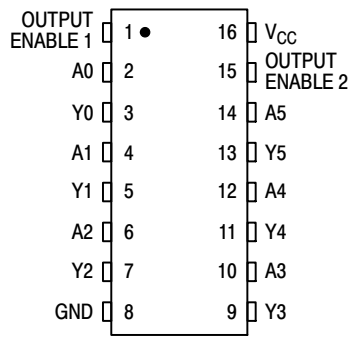

Figure 1. Pin Assignment

FUNCTION TABLE

Inputs			Output
Enable 1	Enable 2	A	Y
L	L	L	H
L	L	H	L
H	X	X	Z
X	H	X	Z

X = don't care

Z = high impedance

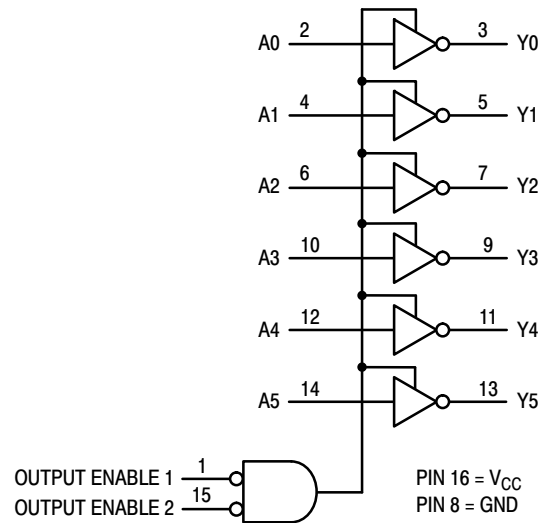

Figure 2. Logic Diagram

ORDERING INFORMATION

Device	Package	Shipping [†]
MC74HCT366ADG	SOIC-16 (Pb-Free)	48 Units / Rail
MC74HCT366ADR2G		2500 Units / Reel
MC74HCT366ADTR2G	TSSOP-16 (Pb-Free)	2500 Units / Reel
NLVHCT366ADTRG*		2500 Units / Reel

[†]For information on tape and reel specifications, including part orientation and tape sizes, please refer to our Tape and Reel Packaging Specifications Brochure, BRD8011/D.

*NLV Prefix for Automotive and Other Applications Requiring Unique Site and Control Change Requirements; AEC-Q100 Qualified and PPAP Capable.

MC74HCT366A

MAXIMUM RATINGS*

Symbol	Parameter	Value	Unit
V_{CC}	DC Supply Voltage (Referenced to GND)	- 0.5 to + 7.0	V
V_{in}	DC Input Voltage (Referenced to GND)	- 0.5 to $V_{CC} + 0.5$	V
V_{out}	DC Output Voltage (Referenced to GND)	- 0.5 to $V_{CC} + 0.5$	V
I_{in}	DC Input Current, per Pin	± 20	mA
I_{out}	DC Output Current, per Pin	± 25	mA
I_{CC}	DC Supply Current, V_{CC} and GND Pins	± 50	mA
P_D	Power Dissipation in Still Air, SOIC Package† TSSOP Package†	500 450	mW
T_{stg}	Storage Temperature	- 65 to + 150	°C

This device contains protection circuitry to guard against damage due to high static voltages or electric fields. However, precautions must be taken to avoid applications of any voltage higher than maximum rated voltages to this high-impedance circuit. For proper operation, V_{in} and V_{out} should be constrained to the range $GND \leq (V_{in} \text{ or } V_{out}) \leq V_{CC}$. Unused inputs must always be tied to an appropriate logic voltage level (e.g., either GND or V_{CC}). Unused outputs must be left open.

Stresses exceeding those listed in the Maximum Ratings table may damage the device. If any of these limits are exceeded, device functionality should not be assumed, damage may occur and reliability may be affected.

†Derating — SOIC Package: - 7 mW/°C from 65° to 125°C
TSSOP Package: - 6.1 mW/°C from 65° to 125°C

RECOMMENDED OPERATING CONDITIONS

Symbol	Parameter	Min	Max	Unit
V_{CC}	DC Supply Voltage (Referenced to GND)	2.0	6.0	V
V_{in}, V_{out}	DC Input Voltage, Output Voltage (Referenced to GND)	0	V_{CC}	V
T_A	Operating Temperature, All Package Types	- 55	+ 125	°C
t_p, t_f	Input Rise and Fall Time (Figure 1)	$V_{CC} = 2.0\text{ V}$ 0 $V_{CC} = 3.0\text{ V}$ 0 $V_{CC} = 4.5\text{ V}$ 0 $V_{CC} = 6.0\text{ V}$ 0	1000 600 500 400	ns

Functional operation above the stresses listed in the Recommended Operating Ranges is not implied. Extended exposure to stresses beyond the Recommended Operating Ranges limits may affect device reliability.

DC ELECTRICAL CHARACTERISTICS (Voltages Referenced to GND)

Symbol	Parameter	Test Conditions	V_{CC} V	Guaranteed Limit			Unit
				- 55 to 25°C	≤ 85°C	≤ 125°C	
V_{IH}	Minimum High-Level Input Voltage	$V_{out} = V_{CC} - 0.1\text{ V}$ $ I_{out} \leq 20\text{ }\mu\text{A}$	4.5 to 5.5	2.0	2.0	2.0	V
V_{IL}	Maximum Low-Level Input Voltage	$V_{out} = 0.1\text{ V}$ $ I_{out} \leq 20\text{ }\mu\text{A}$	4.5 to 5.5	0.80	0.80	0.80	V
V_{OH}	Minimum High-Level Output Voltage	$V_{in} = V_{IH}$ $ I_{out} \leq 20\text{ }\mu\text{A}$	2.0	1.9	1.9	1.9	V
			4.5	4.4	4.4	4.4	
			6.0	5.9	5.9	5.9	
		$V_{in} = V_{IH}$	$ I_{out} \leq 3.6\text{ mA}$	3.0	2.48	2.34	2.20
$ I_{out} \leq 6.0\text{ mA}$	4.5	3.98	3.84	3.70			
$ I_{out} \leq 7.8\text{ mA}$	6.0	5.48	5.34	5.20			
V_{OL}	Maximum Low-Level Output Voltage	$V_{in} = V_{IL}$ $ I_{out} \leq 20\text{ }\mu\text{A}$	2.0	0.1	0.1	0.1	V
			4.5	0.1	0.1	0.1	
			6.0	0.1	0.1	0.1	
		$V_{in} = V_{IL}$	$ I_{out} \leq 3.6\text{ mA}$	3.0	0.26	0.33	0.40
$ I_{out} \leq 6.0\text{ mA}$	4.5	0.26	0.33	0.40			
$ I_{out} \leq 7.8\text{ mA}$	6.0	0.26	0.33	0.40			
I_{in}	Maximum Input Leakage Current	$V_{in} = V_{CC}$ or GND	6.0	± 0.1	± 1.0	± 1.0	μA

MC74HCT366A

DC ELECTRICAL CHARACTERISTICS (Voltages Referenced to GND)

Symbol	Parameter	Test Conditions	V _{CC} V	Guaranteed Limit			Unit
				- 55 to 25°C	≤ 85°C	≤ 125°C	
I _{OZ}	Maximum Three-State Leakage Current	Output in High-Impedance State V _{in} = V _{IL} or V _{IH} V _{out} = V _{CC} or GND	6.0	± 0.5	± 5.0	± 10	μA
I _{CC}	Maximum Quiescent Supply Current (per Package)	V _{in} = V _{CC} or GND I _{out} = 0 μA	6.0	4	40	160	μA

Product parametric performance is indicated in the Electrical Characteristics for the listed test conditions, unless otherwise noted. Product performance may not be indicated by the Electrical Characteristics if operated under different conditions.

AC ELECTRICAL CHARACTERISTICS (C_L = 50 pF, Input t_r = t_f = 6 ns)

Symbol	Parameter	V _{CC} V	Guaranteed Limit			Unit
			- 55 to 25°C	≤ 85°C	≤ 125°C	
t _{PLH} , t _{PHL}	Maximum Propagation Delay, Input A to Output Y (Figures 1 and 3)	2.0	120	150	180	ns
		3.0	60	75	90	
		4.5	24	30	36	
		6.0	20	26	31	
t _{PLZ} , t _{PHZ}	Maximum Propagation Delay, Output Enable to Output Y (Figures 2 and 4)	2.0	220	275	330	ns
		3.0	110	140	170	
		4.5	44	55	66	
		6.0	37	47	56	
t _{PZL} , t _{PZH}	Maximum Propagation Delay, Output Enable to Output Y (Figures 2 and 4)	2.0	220	275	330	ns
		3.0	110	140	170	
		4.5	44	55	66	
		6.0	37	47	56	
t _{TLH} , t _{THL}	Maximum Output Transition Time, Any Output (Figures 1 and 3)	2.0	60	75	90	ns
		3.0	22	28	34	
		4.5	12	15	18	
		6.0	10	13	15	
C _{in}	Maximum Input Capacitance	—	10	10	10	pF
C _{out}	Maximum Three-State Output Capacitance (Output in High-Impedance State)	—	15	15	15	pF
C _{PD}	Power Dissipation Capacitance (Per Buffer)*	Typical @ 25°C, V _{CC} = 5.0 V			pF	
		60				

* Used to determine the no-load dynamic power consumption: $P_D = C_{PD} V_{CC}^2 f + I_{CC} V_{CC}$.

MC74HCT366A

SWITCHING WAVEFORMS

($V_I = 0$ to 3 V, $V_M = 1.3$ V)

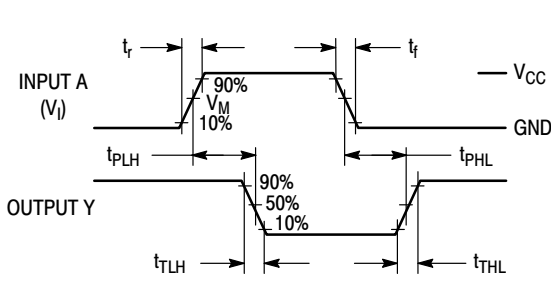

Figure 1.

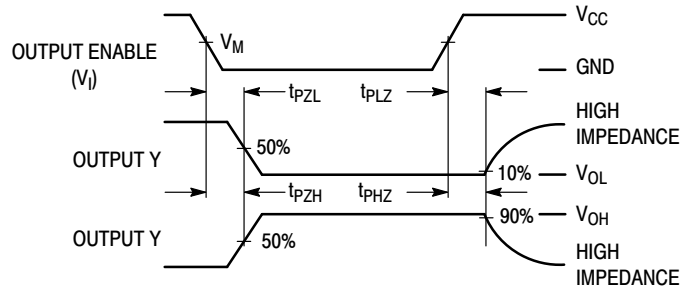
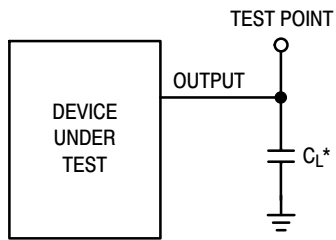

Figure 2.

TEST CIRCUITS



*Includes all probe and jig capacitance

Figure 3.

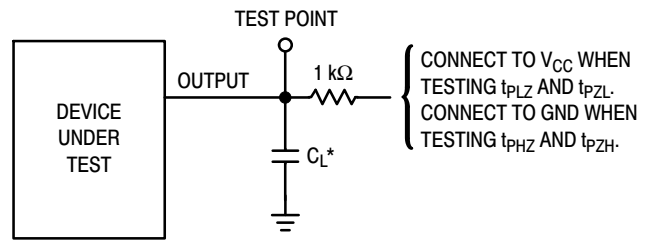

*Includes all probe and jig capacitance

Figure 4.

LOGIC DETAIL

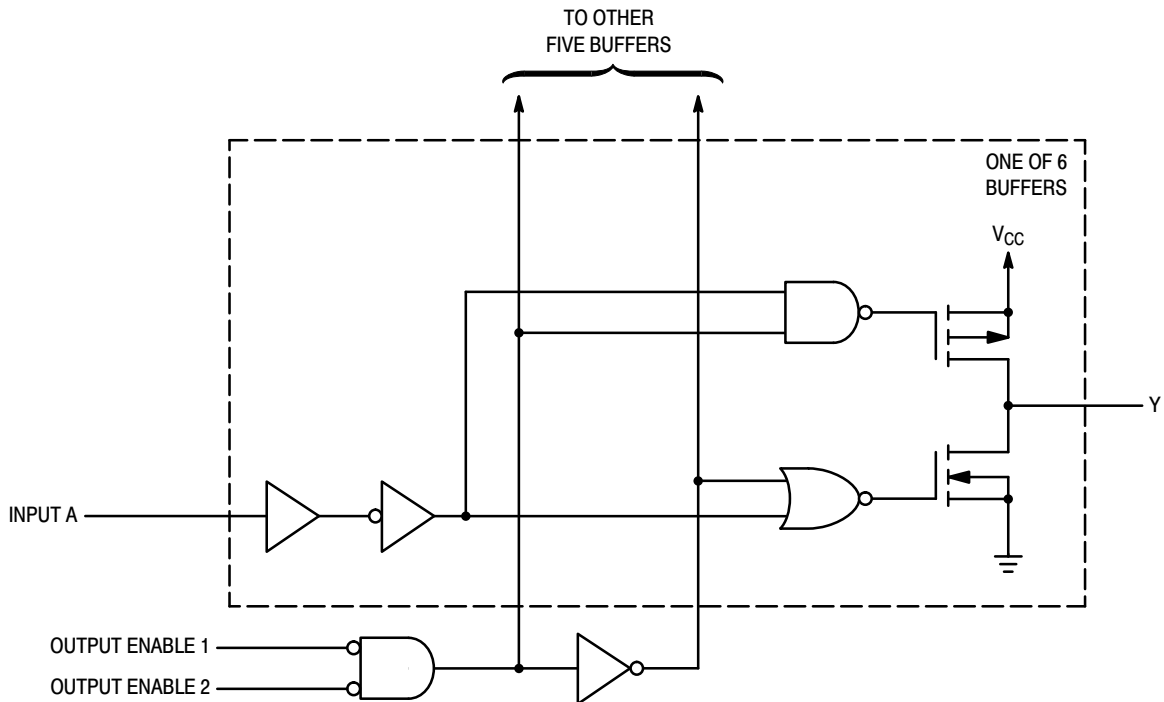

MC74HCT366A

PACKAGE DIMENSIONS

TSSOP-16
DT SUFFIX
CASE 948F
ISSUE B

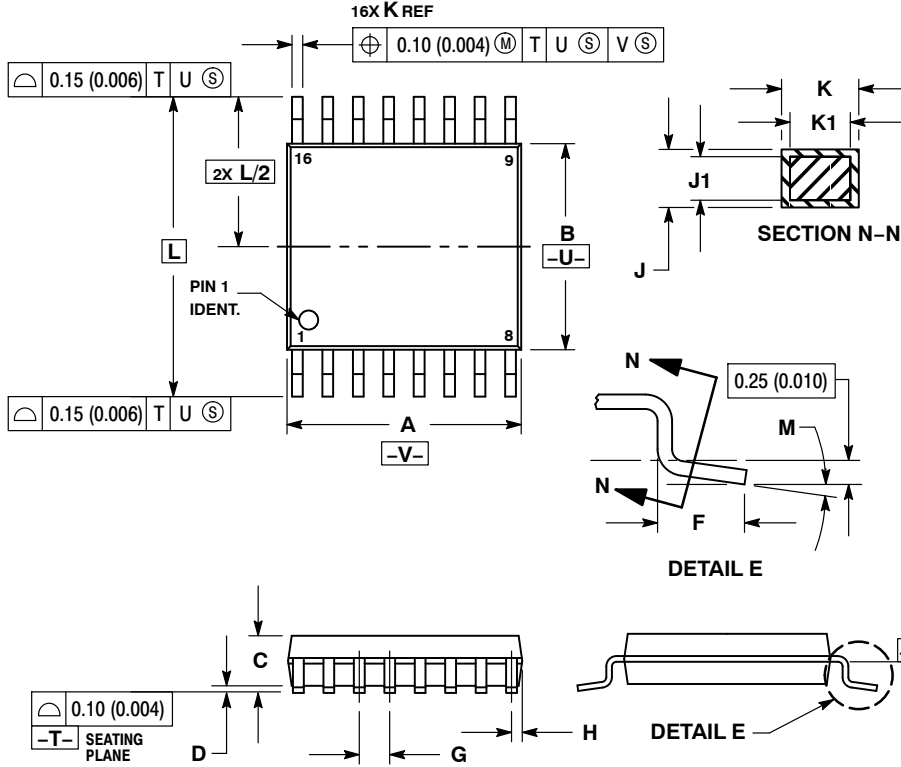

NOTES:

1. DIMENSIONING AND TOLERANCING PER ANSI Y14.5M, 1982.
2. CONTROLLING DIMENSION: MILLIMETER.
3. DIMENSION A DOES NOT INCLUDE MOLD FLASH, PROTRUSIONS OR GATE BURRS. MOLD FLASH OR GATE BURRS SHALL NOT EXCEED 0.15 (0.006) PER SIDE.
4. DIMENSION B DOES NOT INCLUDE INTERLEAD FLASH OR PROTRUSION. INTERLEAD FLASH OR PROTRUSION SHALL NOT EXCEED 0.25 (0.010) PER SIDE.
5. DIMENSION K DOES NOT INCLUDE DAMBAR PROTRUSION. ALLOWABLE DAMBAR PROTRUSION SHALL BE 0.08 (0.003) TOTAL IN EXCESS OF THE K DIMENSION AT MAXIMUM MATERIAL CONDITION.
6. TERMINAL NUMBERS ARE SHOWN FOR REFERENCE ONLY.
7. DIMENSION A AND B ARE TO BE DETERMINED AT DATUM PLANE -W-.

DIM	MILLIMETERS		INCHES	
	MIN	MAX	MIN	MAX
A	4.90	5.10	0.193	0.200
B	4.30	4.50	0.169	0.177
C	---	1.20	---	0.047
D	0.05	0.15	0.002	0.006
F	0.50	0.75	0.020	0.030
G	0.65 BSC		0.026 BSC	
H	0.18	0.28	0.007	0.011
J	0.09	0.20	0.004	0.008
J1	0.09	0.16	0.004	0.006
K	0.19	0.30	0.007	0.012
K1	0.19	0.25	0.007	0.010
L	6.40 BSC		0.252 BSC	
M	0°	8°	0°	8°

SOLDERING FOOTPRINT

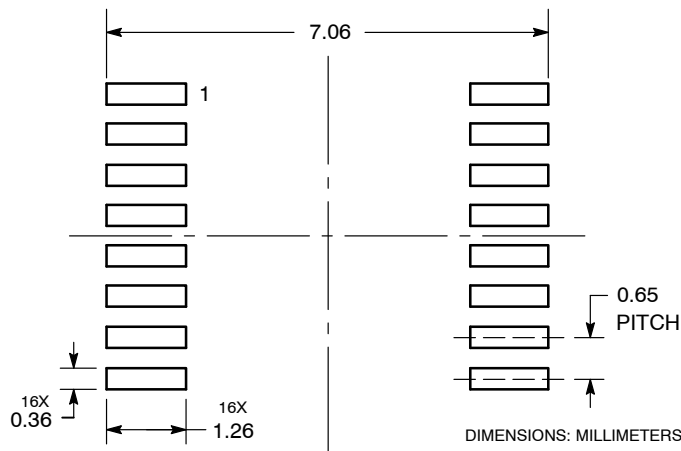

MC74HCT366A

PACKAGE DIMENSIONS

SOIC-16
D SUFFIX
CASE 751B-05
ISSUE K

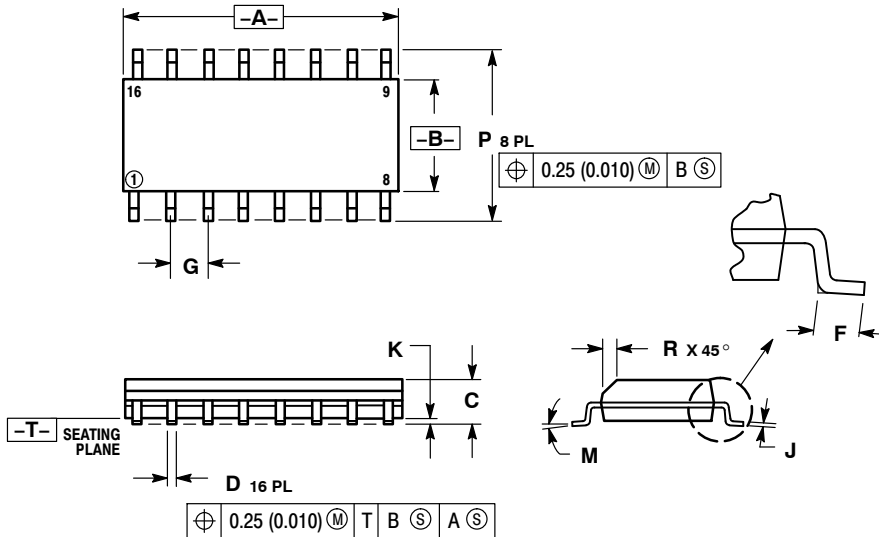

NOTES:

- DIMENSIONING AND TOLERANCING PER ANSI Y14.5M, 1982.
- CONTROLLING DIMENSION: MILLIMETER.
- DIMENSIONS A AND B DO NOT INCLUDE MOLD PROTRUSION.
- MAXIMUM MOLD PROTRUSION 0.15 (0.006) PER SIDE.
- DIMENSION D DOES NOT INCLUDE DAMBAR PROTRUSION. ALLOWABLE DAMBAR PROTRUSION SHALL BE 0.127 (0.005) TOTAL IN EXCESS OF THE D DIMENSION AT MAXIMUM MATERIAL CONDITION.

DIM	MILLIMETERS		INCHES	
	MIN	MAX	MIN	MAX
A	9.80	10.00	0.386	0.393
B	3.80	4.00	0.150	0.157
C	1.35	1.75	0.054	0.068
D	0.35	0.49	0.014	0.019
F	0.40	1.25	0.016	0.049
G	1.27 BSC		0.050 BSC	
J	0.19	0.25	0.008	0.009
K	0.10	0.25	0.004	0.009
M	0°	7°	0°	7°
P	5.80	6.20	0.229	0.244
R	0.25	0.50	0.010	0.019

SOLDERING FOOTPRINT

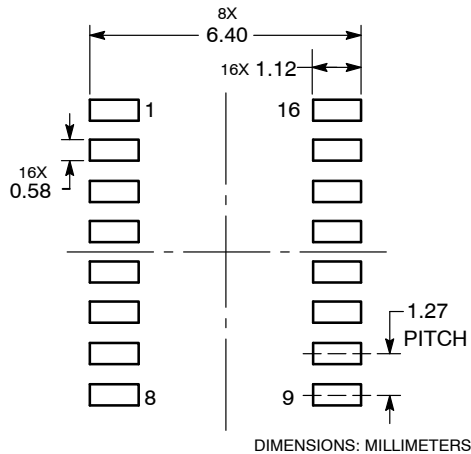

ON Semiconductor and are registered trademarks of Semiconductor Components Industries, LLC (SCILLC). SCILLC owns the rights to a number of patents, trademarks, copyrights, trade secrets, and other intellectual property. A listing of SCILLC's product/patent coverage may be accessed at www.onsemi.com/site/pdf/Patent-Marking.pdf. SCILLC reserves the right to make changes without further notice to any products herein. SCILLC makes no warranty, representation or guarantee regarding the suitability of its products for any particular purpose, nor does SCILLC assume any liability arising out of the application or use of any product or circuit, and specifically disclaims any and all liability, including without limitation special, consequential or incidental damages. "Typical" parameters which may be provided in SCILLC data sheets and/or specifications can and do vary in different applications and actual performance may vary over time. All operating parameters, including "Typicals" must be validated for each customer application by customer's technical experts. SCILLC does not convey any license under its patent rights nor the rights of others. SCILLC products are not designed, intended, or authorized for use as components in systems intended for surgical implant into the body, or other applications intended to support or sustain life, or for any other application in which the failure of the SCILLC product could create a situation where personal injury or death may occur. Should Buyer purchase or use SCILLC products for any such unintended or unauthorized application, Buyer shall indemnify and hold SCILLC and its officers, employees, subsidiaries, affiliates, and distributors harmless against all claims, costs, damages, and expenses, and reasonable attorney fees arising out of, directly or indirectly, any claim of personal injury or death associated with such unintended or unauthorized use, even if such claim alleges that SCILLC was negligent regarding the design or manufacture of the part. SCILLC is an Equal Opportunity/Affirmative Action Employer. This literature is subject to all applicable copyright laws and is not for resale in any manner.

PUBLICATION ORDERING INFORMATION

LITERATURE FULFILLMENT:

Literature Distribution Center for ON Semiconductor
P.O. Box 5163, Denver, Colorado 80217 USA
Phone: 303-675-2175 or 800-344-3860 Toll Free USA/Canada
Fax: 303-675-2176 or 800-344-3867 Toll Free USA/Canada
Email: orderlit@onsemi.com

N. American Technical Support: 800-282-9855 Toll Free
USA/Canada
Europe, Middle East and Africa Technical Support:
Phone: 421 33 790 2910
Japan Customer Focus Center
Phone: 81-3-5817-1050

ON Semiconductor Website: www.onsemi.com

Order Literature: <http://www.onsemi.com/orderlit>

For additional information, please contact your local Sales Representative

Looking for pricing, stock, or lifecycle information?

Click below to explore more details on WIN SOURCE:

 [View MC74HCT366ADTG on WIN SOURCE](#)

 [ON Semiconductor](#) Information

Optimize Your Supply Chain with WIN SOURCE Solutions

-  Global Sourcing Solution
-  Obsolete Management
-  Cost Control Management
-  Shortage Management
-  Alternative Solution
-  Excess Inventory Management