



**THE DATASHEET OF  
SN74AS158N**



# SN54ALS157A, SN54ALS158 SN74ALS157A, SN74ALS158, SN74AS157, SN74AS158 QUADRUPLE 1-OF-2 DATA SELECTORS/MULTIPLEXERS

SDAS081C – APRIL 1982 – REVISED DECEMBER 1994

- Buffered Inputs and Outputs
- Package Options Include Plastic Small-Outline (D) Packages, Ceramic Chip Carriers (FK), and Standard Plastic (N) and Ceramic (J) 300-mil DIPs

## description

These data selectors/multiplexers contain inverters and drivers to supply full data selection to the four output gates. A separate strobe ( $\bar{G}$ ) input is provided. A 4-bit word is selected from one of two sources and is routed to the four outputs. The 'ALS157A and SN74AS157 present true data. The 'ALS158 and SN74AS158 present inverted data to minimize propagation delay time.

The SN54ALS157A and SN54ALS158 are characterized for operation over the full military temperature range of  $-55^{\circ}\text{C}$  to  $125^{\circ}\text{C}$ . The SN74ALS157A, SN74ALS158, SN74AS157, and SN74AS158 are characterized for operation from  $0^{\circ}\text{C}$  to  $70^{\circ}\text{C}$ .

SN54ALS157A, SN54ALS158 . . . J PACKAGE  
SN74ALS157A, SN74ALS158,  
SN74AS157, SN74AS158 . . . D OR N PACKAGE  
(TOP VIEW)

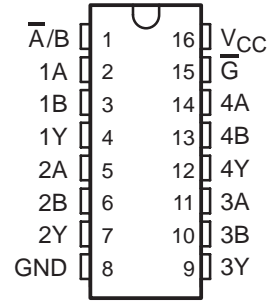

SN54ALS157A, SN54ALS158 . . . FK PACKAGE  
(TOP VIEW)

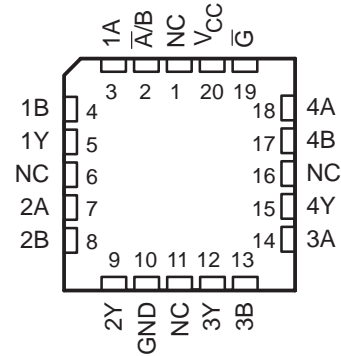

NC – No internal connection

FUNCTION TABLE

| INPUTS    |             | OUTPUT Y |   |                       |                      |
|-----------|-------------|----------|---|-----------------------|----------------------|
| $\bar{G}$ | $\bar{A/B}$ | DATA     |   | 'ALS157A<br>SN74AS157 | 'ALS158<br>SN74AS158 |
|           |             | A        | B |                       |                      |
| H         | X           | X        | X | L                     | H                    |
| L         | L           | L        | X | L                     | H                    |
| L         | L           | H        | X | H                     | L                    |
| L         | H           | X        | L | L                     | H                    |
| L         | H           | X        | H | H                     | L                    |

**SN54ALS157A, SN54ALS158**  
**SN74ALS157A, SN74ALS158, SN74AS157, SN74AS158**  
**QUAD 1-OF-2 DATA SELECTORS/MULTIPLEXERS**

SDAS081C – APRIL 1982 – REVISED DECEMBER 1994

**logic symbols†**

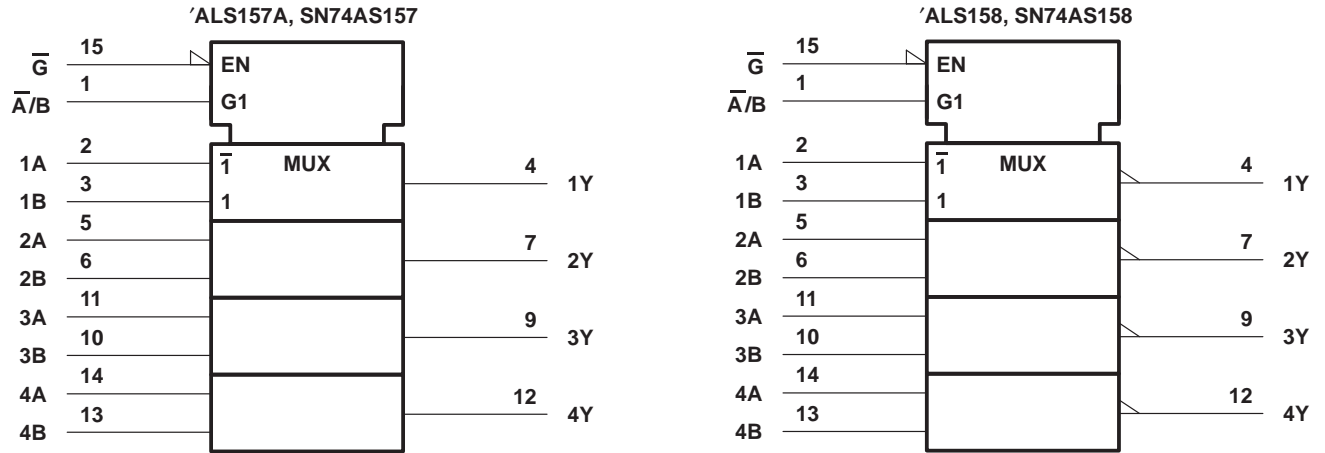

† These symbols are in accordance with ANSI/IEEE Std 91-1984 and IEC Publication 617-12.  
 Pin numbers shown are for the D, J, and N packages.

**SN54ALS157A, SN54ALS158**  
**SN74ALS157A, SN74ALS158, SN74AS157, SN74AS158**  
**QUAD 1-OF-2 DATA SELECTORS/MULTIPLEXERS**

SDAS081C - APRIL 1982 - REVISED DECEMBER 1994

**logic diagrams (positive logic)**

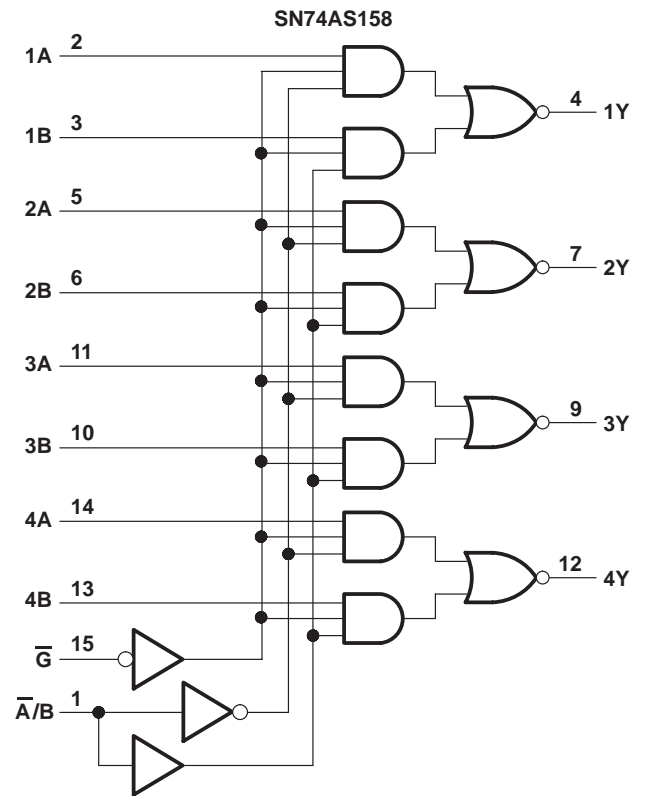
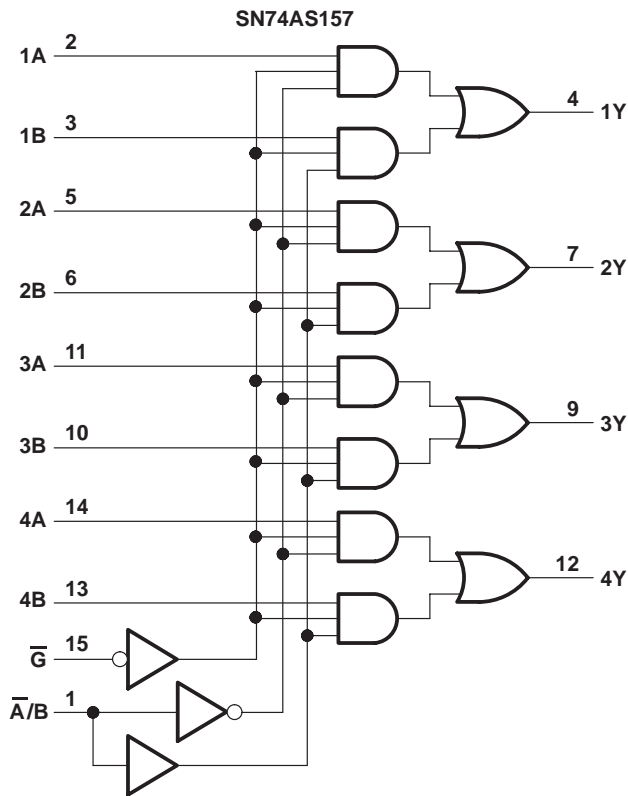
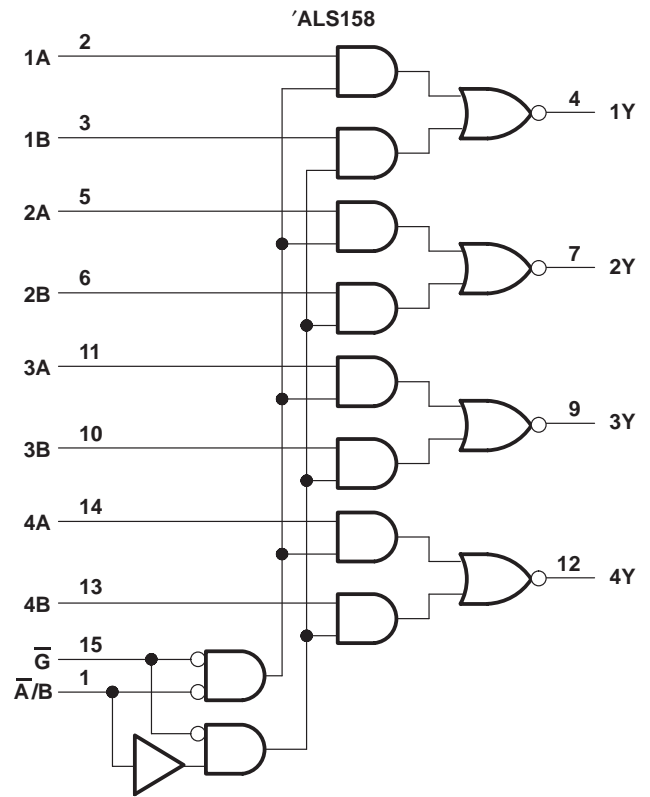
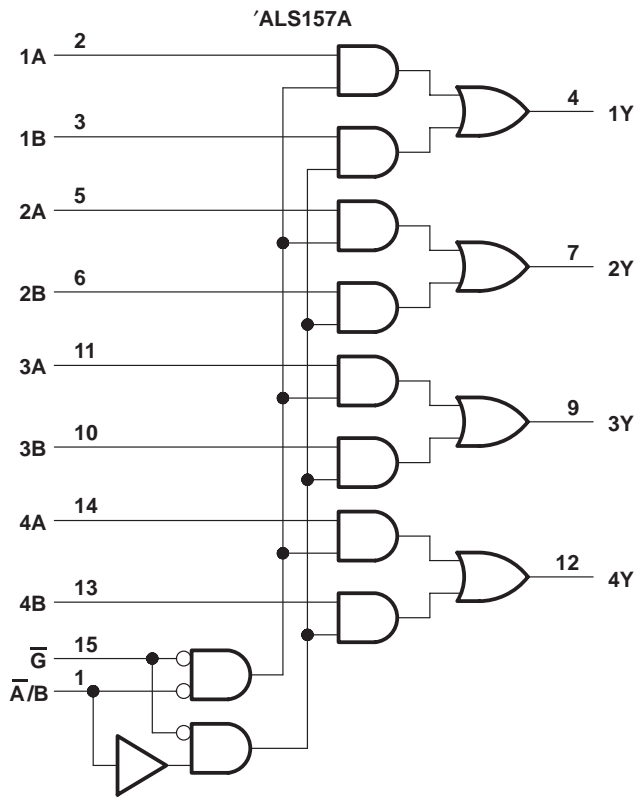

Pin numbers shown are for the D, J, and N packages.



**SN54ALS157A, SN54ALS158**  
**SN74ALS157A, SN74ALS158, SN74AS157, SN74AS158**  
**QUAD 1-OF-2 DATA SELECTORS/MULTIPLEXERS**

SDAS081C – APRIL 1982 – REVISED DECEMBER 1994

**absolute maximum ratings over operating free-air temperature range (unless otherwise noted)†**

|   |                |
|---|----------------|
| Supply voltage, $V_{CC}$ .....  | 7 V            |
| Input voltage, $V_I$ .....  | 7 V            |
| Operating free-air temperature range, $T_A$ : SN54ALS157A, SN54ALS158 ..... | -55°C to 125°C |
| SN74ALS157A, SN74ALS158 .....   | 0°C to 70°C    |
| Storage temperature range .....   | -65°C to 150°C |

† Stresses beyond those listed under “absolute maximum ratings” may cause permanent damage to the device. These are stress ratings only, and functional operation of the device at these or any other conditions beyond those indicated under “recommended operating conditions” is not implied. Exposure to absolute-maximum-rated conditions for extended periods may affect device reliability.

**recommended operating conditions**

|          |                                | SN54ALS157A<br>SN54ALS158 |     |      | SN74ALS157A<br>SN74ALS158 |     |      | UNIT |
|----------|--------------------------------|---------------------------|-----|------|---------------------------|-----|------|------|
|          |                                | MIN                       | NOM | MAX  | MIN                       | NOM | MAX  |      |
| $V_{CC}$ | Supply voltage                 | 4.5                       | 5   | 5.5  | 4.5                       | 5   | 5.5  | V    |
| $V_{IH}$ | High-level input voltage       | 2                         |     |      | 2                         |     |      | V    |
| $V_{IL}$ | Low-level input voltage        |                           |     | 0.7  |                           |     | 0.8  | V    |
| $I_{OH}$ | High-level output current      |                           |     | -0.4 |                           |     | -0.4 | mA   |
| $I_{OL}$ | Low-level output current       |                           |     | 4    |                           |     | 8    | mA   |
| $T_A$    | Operating free-air temperature | -55                       |     | 125  | 0                         |     | 70   | °C   |

**electrical characteristics over recommended operating free-air temperature range (unless otherwise noted)**

| PARAMETER    | TEST CONDITIONS                                  | SN54ALS157A<br>SN54ALS158        |      |      | SN74ALS157A<br>SN74ALS158 |      |      | UNIT |    |
|--------------|--|----------------------------------|------|------|---------------------------|------|------|------|----|
|              |  | MIN                              | TYP‡ | MAX  | MIN                       | TYP‡ | MAX  |      |    |
| $V_{IK}$     | $V_{CC} = 4.5 V$ , $I_I = -18 mA$                |                                  |      | -1.2 |                           |      | -1.2 | V    |    |
| $V_{OH}$     | $V_{CC} = 4.5 V$ to $5.5 V$ , $I_{OH} = -0.4 mA$ | $V_{CC} - 2$                     |      |      | $V_{CC} - 2$              |      |      | V    |    |
| $V_{OL}$     | $V_{CC} = 4.5 V$                                 |                                  | 0.25 | 0.4  |                           | 0.25 | 0.4  | V    |    |
|              |  |                                  |      |      |                           | 0.35 | 0.5  |      |    |
| $I_I$        | $V_{CC} = 5.5 V$ , $V_I = 7 V$                   |                                  |      | 0.1  |                           |      | 0.1  | mA   |    |
| $I_{IH}$     | $V_{CC} = 5.5 V$ , $V_I = 2.7 V$                 |                                  |      | 20   |                           |      | 20   | μA   |    |
| $I_{IL}$     | $V_{CC} = 5.5 V$ , $V_I = 0.4 V$                 |                                  |      | -0.1 |                           |      | -0.1 | mA   |    |
| $I_{O}^{\S}$ | $V_{CC} = 5.5 V$ , $V_O = 2.25 V$                | -20                              |      | -112 | -30                       |      | -112 | mA   |    |
| $I_{CC}$     | 'ALS157A   | $V_{CC} = 5.5 V$ ,<br>See Note 1 |      | 6    | 11                        |      | 6    | 11   | mA |
|              | 'ALS158  |                                  |      | 5    | 10                        |      | 5    | 10   |    |

‡ All typical values are at  $V_{CC} = 5 V$ ,  $T_A = 25^\circ C$ .

§ The output conditions have been chosen to produce a current that closely approximates one half of the true short-circuit output current,  $I_{OS}$ .

NOTE 1:  $I_{CC}$  is measured with 4.5 V applied to all inputs and all outputs open.



**SN54ALS157A, SN54ALS158**  
**SN74ALS157A, SN74ALS158, SN74ALS157, SN74ALS158**  
**QUAD 1-OF-2 DATA SELECTORS/MULTIPLEXERS**

SDAS081C – APRIL 1982 – REVISED DECEMBER 1994

**switching characteristics (see Figure 1)**

| PARAMETER        | FROM (INPUT) | TO (OUTPUT) | V <sub>CC</sub> = 5 V,<br>C <sub>L</sub> = 50 pF,<br>R <sub>L</sub> = 500 Ω,<br>T <sub>A</sub> = 25°C | V <sub>CC</sub> = 4.5 V to 5.5 V,<br>C <sub>L</sub> = 50 pF,<br>R <sub>L</sub> = 500 Ω,<br>T <sub>A</sub> = MIN to MAX† |             |     |             | UNIT |     |
|------------------|--------------|-------------|---|---|-------------|-----|-------------|------|-----|
|                  |              |             |   | ALS157A   | SN54ALS157A |     | SN74ALS157A |      |     |
|                  |              |             |   | TYP   | MIN         | MAX | MIN         |      | MAX |
| t <sub>PLH</sub> | A or B       | Y           | 9   | 4   | 17          | 4   | 14          | ns   |     |
| t <sub>PHL</sub> |              |             | 6   | 2   | 15          | 2   | 12          |      |     |
| t <sub>PLH</sub> | $\bar{A}/B$  | Y           | 15  | 7   | 28          | 7   | 24          | ns   |     |
| t <sub>PHL</sub> |              |             | 9   | 4   | 20          | 4   | 17          |      |     |
| t <sub>PLH</sub> | $\bar{G}$    | Y           | 14  | 7   | 25          | 7   | 20          | ns   |     |
| t <sub>PHL</sub> |              |             | 10  | 4   | 18          | 4   | 13          |      |     |

† For conditions shown as MIN or MAX, use the appropriate value specified under recommended operating conditions.

**switching characteristics (see Figure 1)**

| PARAMETER        | FROM (INPUT) | TO (OUTPUT) | V <sub>CC</sub> = 5 V,<br>C <sub>L</sub> = 50 pF,<br>R <sub>L</sub> = 500 Ω,<br>T <sub>A</sub> = 25°C | V <sub>CC</sub> = 4.5 V to 5.5 V,<br>C <sub>L</sub> = 50 pF,<br>R <sub>L</sub> = 500 Ω,<br>T <sub>A</sub> = MIN to MAX† |            |     |            | UNIT |     |
|------------------|--------------|-------------|---|---|------------|-----|------------|------|-----|
|                  |              |             |   | ALS158  | SN54ALS158 |     | SN74ALS158 |      |     |
|                  |              |             |   | TYP   | MIN        | MAX | MIN        |      | MAX |
| t <sub>PLH</sub> | A or B       | Y           | 9   | 4   | 18         | 4   | 15         | ns   |     |
| t <sub>PHL</sub> |              |             | 5   | 2   | 12         | 2   | 8          |      |     |
| t <sub>PLH</sub> | $\bar{A}/B$  | Y           | 13  | 5   | 22         | 5   | 18         | ns   |     |
| t <sub>PHL</sub> |              |             | 13  | 5   | 22         | 5   | 18         |      |     |
| t <sub>PLH</sub> | $\bar{G}$    | Y           | 13  | 5   | 22         | 5   | 18         | ns   |     |
| t <sub>PHL</sub> |              |             | 13  | 5   | 22         | 5   | 18         |      |     |

† For conditions shown as MIN or MAX, use the appropriate value specified under recommended operating conditions.



**SN54ALS157A, SN54ALS158**  
**SN74ALS157A, SN74ALS158, SN74AS157, SN74AS158**  
**QUAD 1-OF-2 DATA SELECTORS/MULTIPLEXERS**

SDAS081C – APRIL 1982 – REVISED DECEMBER 1994

**absolute maximum ratings over operating free-air temperature range (unless otherwise noted)†**

|  |                |
|--|----------------|
| Supply voltage, $V_{CC}$   | 7 V            |
| Input voltage, $V_I$   | 7 V            |
| Operating free-air temperature range, $T_A$ : SN74AS157, SN74AS158 | 0°C to 70°C    |
| Storage temperature range  | -65°C to 150°C |

† Stresses beyond those listed under “absolute maximum ratings” may cause permanent damage to the device. These are stress ratings only, and functional operation of the device at these or any other conditions beyond those indicated under “recommended operating conditions” is not implied. Exposure to absolute-maximum-rated conditions for extended periods may affect device reliability.

**recommended operating conditions**

|          |                                | SN74AS157<br>SN74AS158 |     |     | UNIT |
|----------|--------------------------------|------------------------|-----|-----|------|
|          |                                | MIN                    | NOM | MAX |      |
| $V_{CC}$ | Supply voltage                 | 4.5                    | 5   | 5.5 | V    |
| $V_{IH}$ | High-level input voltage       | 2                      |     |     | V    |
| $V_{IL}$ | Low-level input voltage        |                        |     | 0.8 | V    |
| $I_{OH}$ | High-level output current      |                        |     | -2  | mA   |
| $I_{OL}$ | Low-level output current       |                        |     | 20  | mA   |
| $T_A$    | Operating free-air temperature | 0                      |     | 70  | °C   |

**electrical characteristics over recommended operating free-air temperature range (unless otherwise noted)**

| PARAMETER    | TEST CONDITIONS                                | SN74AS157<br>SN74AS158           |      |      | UNIT    |
|--------------|--|----------------------------------|------|------|---------|
|              |  | MIN                              | TYP‡ | MAX  |         |
| $V_{IK}$     | $V_{CC} = 4.5 V$ , $I_I = -18 mA$              |                                  |      | -1.2 | V       |
| $V_{OH}$     | $V_{CC} = 4.5 V$ to $5.5 V$ , $I_{OH} = -2 mA$ | $V_{CC} - 2$                     |      |      | V       |
| $V_{OL}$     | $V_{CC} = 4.5 V$ , $I_{OL} = 20 mA$            |                                  | 0.35 | 0.5  | V       |
| $I_I$        | $\bar{A}/B$                                    | $V_{CC} = 5.5 V$ , $V_I = 7 V$   |      | 0.2  | mA      |
|              | A, B, or $\bar{G}$                             |                                  |      | 0.1  |         |
| $I_{IH}$     | $\bar{A}/B$                                    | $V_{CC} = 5.5 V$ , $V_I = 2.7 V$ |      | 40   | $\mu A$ |
|              | A, B, or $\bar{G}$                             |                                  |      | 20   |         |
| $I_{IL}$     | $\bar{A}/B$                                    | $V_{CC} = 5.5 V$ , $V_I = 0.4 V$ |      | -1   | mA      |
|              | A, B, or $\bar{G}$                             |                                  |      | -0.5 |         |
| $I_{O}^{\S}$ | $V_{CC} = 5.5 V$ , $V_O = 2.25 V$              | -30                              |      | -112 | mA      |
| $I_{CC}$     | SN74AS157                                      | $V_{CC} = 5.5 V$                 |      | 17.5 | mA      |
|              | SN74AS158                                      |                                  |      | 15.6 |         |

‡ All typical values are at  $V_{CC} = 5 V$ ,  $T_A = 25^\circ C$ .

§ The output conditions have been chosen to produce a current that closely approximates one half of the true short-circuit output current,  $I_{OS}$ .



**SN54ALS157A, SN54ALS158**  
**SN74ALS157A, SN74ALS158, SN74AS157, SN74AS158**  
**QUAD 1-OF-2 DATA SELECTORS/MULTIPLEXERS**

SDAS081C – APRIL 1982 – REVISED DECEMBER 1994

**switching characteristics (see Figure 1)**

| PARAMETER        | FROM<br>(INPUT) | TO<br>(OUTPUT) | V <sub>CC</sub> = 4.5 V to 5.5 V,<br>C <sub>L</sub> = 50 pF,<br>R <sub>L</sub> = 500 Ω,<br>T <sub>A</sub> = MIN to MAX† |      | UNIT |
|------------------|-----------------|----------------|---|------|------|
|                  |                 |                | SN74AS157   |      |      |
|                  |                 |                | MIN   | MAX  |      |
| t <sub>PLH</sub> | A or B          | Y              | 1   | 6    | ns   |
| t <sub>PHL</sub> |                 |                | 1   | 5.5  |      |
| t <sub>PLH</sub> | $\bar{A}/B$     | Y              | 2   | 11   | ns   |
| t <sub>PHL</sub> |                 |                | 2   | 10   |      |
| t <sub>PLH</sub> | $\bar{G}$       | Y              | 2   | 10.5 | ns   |
| t <sub>PHL</sub> |                 |                | 2   | 7.5  |      |

† For conditions shown as MIN or MAX, use the appropriate value specified under recommended operating conditions.

**switching characteristics (see Figure 1)**

| PARAMETER        | FROM<br>(INPUT) | TO<br>(OUTPUT) | V <sub>CC</sub> = 4.5 V to 5.5 V,<br>C <sub>L</sub> = 50 pF,<br>R <sub>L</sub> = 500 Ω,<br>T <sub>A</sub> = MIN to MAX† |      | UNIT |
|------------------|-----------------|----------------|---|------|------|
|                  |                 |                | SN74AS158   |      |      |
|                  |                 |                | MIN   | MAX  |      |
| t <sub>PLH</sub> | A or B          | Y              | 1   | 5    | ns   |
| t <sub>PHL</sub> |                 |                | 1   | 4.5  |      |
| t <sub>PLH</sub> | $\bar{A}/B$     | Y              | 2   | 9.5  | ns   |
| t <sub>PHL</sub> |                 |                | 2   | 10.5 |      |
| t <sub>PLH</sub> | $\bar{G}$       | Y              | 2   | 6.5  | ns   |
| t <sub>PHL</sub> |                 |                | 2   | 10   |      |

† For conditions shown as MIN or MAX, use the appropriate value specified under recommended operating conditions.



**SN54ALS157A, SN54ALS158**  
**SN74ALS157A, SN74ALS158, SN74AS157, SN74AS158**  
**QUAD 1-OF-2 DATA SELECTORS/MULTIPLEXERS**

SDAS081C – APRIL 1982 – REVISED DECEMBER 1994

**PARAMETER MEASUREMENT INFORMATION**  
**SERIES 54ALS/74ALS AND 54AS/74AS DEVICES**

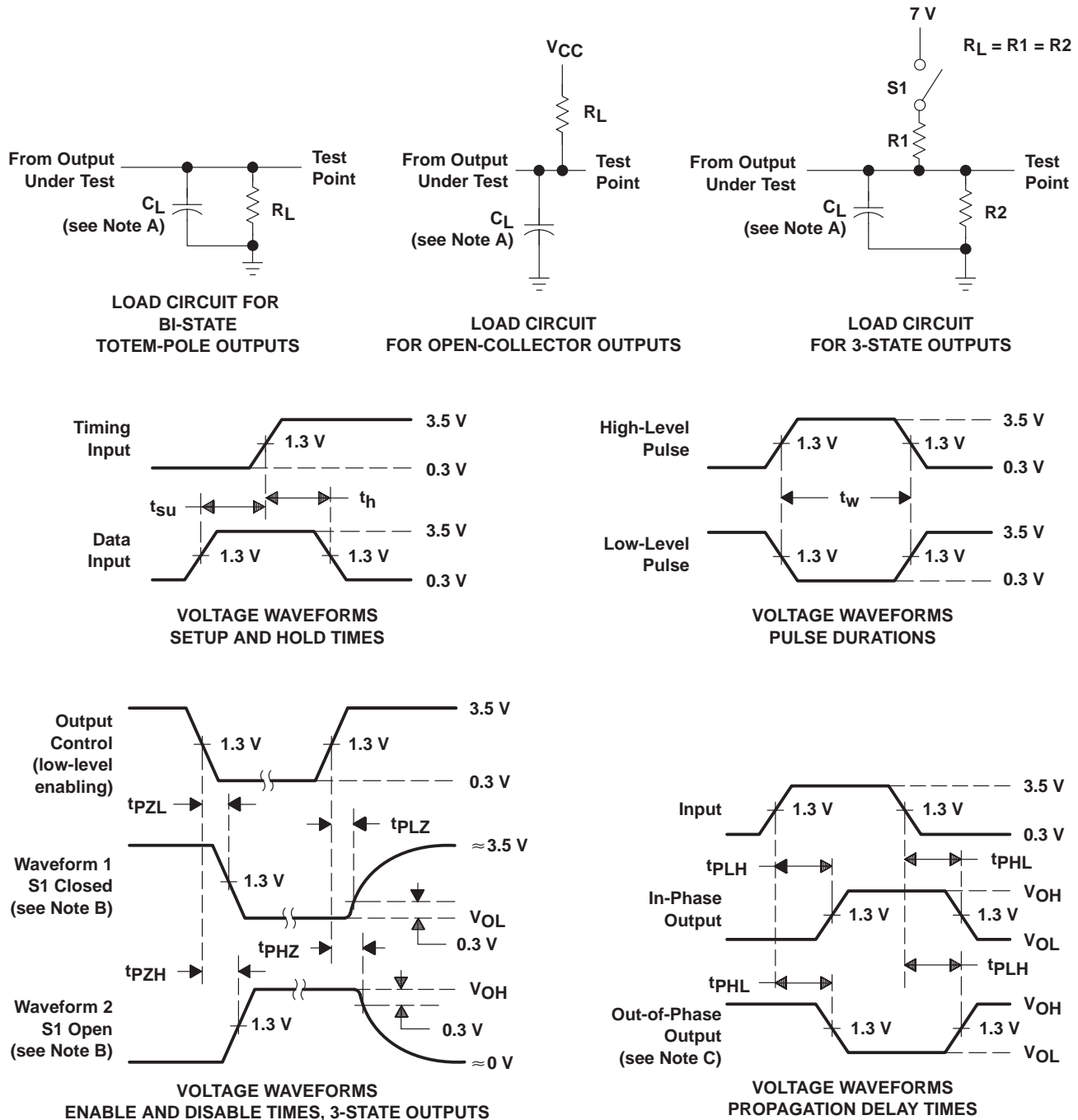



- NOTES: A.  $C_L$  includes probe and jig capacitance.  
 B. Waveform 1 is for an output with internal conditions such that the output is low except when disabled by the output control. Waveform 2 is for an output with internal conditions such that the output is high except when disabled by the output control.  
 C. When measuring propagation delay items of 3-state outputs, switch S1 is open.  
 D. All input pulses have the following characteristics: PRR  $\leq$  1 MHz,  $t_r = t_f = 2$  ns, duty cycle = 50%.  
 E. The outputs are measured one at a time with one transition per measurement.

**Figure 1. Load Circuits and Voltage Waveforms**



**PACKAGING INFORMATION**

| Orderable Device | Status<br>(1) | Package Type | Package Drawing | Pins | Package Qty | Eco Plan<br>(2)         | Lead/Ball Finish<br>(6) | MSL Peak Temp<br>(3) | Op Temp (°C) | Device Marking<br>(4/5)              | Samples                 |
|------------------|---------------|--------------|-----------------|------|-------------|-------------------------|-------------------------|----------------------|--------------|--------------------------------------|-------------------------|
| 5962-86869012A   | ACTIVE        | LCCC         | FK              | 20   | 1           | TBD                     | POST-PLATE              | N / A for Pkg Type   | -55 to 125   | 5962-86869012A<br>SNJ54ALS<br>157AFK | <a href="#">Samples</a> |
| 5962-8686901EA   | ACTIVE        | CDIP         | J               | 16   | 1           | TBD                     | A42                     | N / A for Pkg Type   | -55 to 125   | 5962-8686901EA<br>SNJ54ALS157AJ      | <a href="#">Samples</a> |
| 5962-8862501EA   | ACTIVE        | CDIP         | J               | 16   | 1           | TBD                     | A42                     | N / A for Pkg Type   | -55 to 125   | 5962-8862501EA<br>SNJ54ALS158J       | <a href="#">Samples</a> |
| SN54ALS157AJ     | ACTIVE        | CDIP         | J               | 16   | 1           | TBD                     | A42                     | N / A for Pkg Type   | -55 to 125   | SN54ALS157AJ                         | <a href="#">Samples</a> |
| SN74ALS157AD     | ACTIVE        | SOIC         | D               | 16   | 40          | Green (RoHS & no Sb/Br) | CU NIPDAU               | Level-1-260C-UNLIM   | 0 to 70      | ALS157A                              | <a href="#">Samples</a> |
| SN74ALS157ADR    | ACTIVE        | SOIC         | D               | 16   | 2500        | Green (RoHS & no Sb/Br) | CU NIPDAU               | Level-1-260C-UNLIM   | 0 to 70      | ALS157A                              | <a href="#">Samples</a> |
| SN74ALS157AN     | ACTIVE        | PDIP         | N               | 16   | 25          | Green (RoHS & no Sb/Br) | CU NIPDAU               | N / A for Pkg Type   | 0 to 70      | SN74ALS157AN                         | <a href="#">Samples</a> |
| SN74ALS157ANSR   | ACTIVE        | SO           | NS              | 16   | 2000        | Green (RoHS & no Sb/Br) | CU NIPDAU               | Level-1-260C-UNLIM   | 0 to 70      | ALS157A                              | <a href="#">Samples</a> |
| SN74ALS158D      | ACTIVE        | SOIC         | D               | 16   | 40          | Green (RoHS & no Sb/Br) | CU NIPDAU               | Level-1-260C-UNLIM   | 0 to 70      | ALS158                               | <a href="#">Samples</a> |
| SN74ALS158N      | ACTIVE        | PDIP         | N               | 16   | 25          | Green (RoHS & no Sb/Br) | CU NIPDAU               | N / A for Pkg Type   | 0 to 70      | SN74ALS158N                          | <a href="#">Samples</a> |
| SN74ALS158NE4    | ACTIVE        | PDIP         | N               | 16   | 25          | Green (RoHS & no Sb/Br) | CU NIPDAU               | N / A for Pkg Type   | 0 to 70      | SN74ALS158N                          | <a href="#">Samples</a> |
| SN74ALS158NSR    | ACTIVE        | SO           | NS              | 16   | 2000        | Green (RoHS & no Sb/Br) | CU NIPDAU               | Level-1-260C-UNLIM   | 0 to 70      | ALS158                               | <a href="#">Samples</a> |
| SN74AS157D       | ACTIVE        | SOIC         | D               | 16   | 40          | Green (RoHS & no Sb/Br) | CU NIPDAU               | Level-1-260C-UNLIM   | 0 to 70      | AS157                                | <a href="#">Samples</a> |
| SN74AS157N       | ACTIVE        | PDIP         | N               | 16   | 25          | Green (RoHS & no Sb/Br) | CU NIPDAU               | N / A for Pkg Type   | 0 to 70      | SN74AS157N                           | <a href="#">Samples</a> |
| SN74AS158D       | ACTIVE        | SOIC         | D               | 16   | 40          | Green (RoHS & no Sb/Br) | CU NIPDAU               | Level-1-260C-UNLIM   | 0 to 70      | AS158                                | <a href="#">Samples</a> |
| SN74AS158N       | ACTIVE        | PDIP         | N               | 16   | 25          | Green (RoHS & no Sb/Br) | CU NIPDAU               | N / A for Pkg Type   | 0 to 70      | SN74AS158N                           | <a href="#">Samples</a> |

| Orderable Device | Status<br>(1) | Package Type | Package Drawing | Pins | Package Qty | Eco Plan<br>(2) | Lead/Ball Finish<br>(6) | MSL Peak Temp<br>(3) | Op Temp (°C) | Device Marking<br>(4/5)          | Samples   |
|------------------|---------------|--------------|-----------------|------|-------------|-----------------|-------------------------|----------------------|--------------|----------------------------------|---|
| SNJ54ALS157AFK   | ACTIVE        | LCCC         | FK              | 20   | 1           | TBD             | POST-PLATE              | N / A for Pkg Type   | -55 to 125   | 5962-86869012A<br>SNJ54ALS157AFK |  |
| SNJ54ALS157AJ    | ACTIVE        | CDIP         | J               | 16   | 1           | TBD             | A42                     | N / A for Pkg Type   | -55 to 125   | 5962-8686901EA<br>SNJ54ALS157AJ  |  |
| SNJ54ALS158J     | ACTIVE        | CDIP         | J               | 16   | 1           | TBD             | A42                     | N / A for Pkg Type   | -55 to 125   | 5962-8862501EA<br>SNJ54ALS158J   |  |

(1) The marketing status values are defined as follows:

**ACTIVE:** Product device recommended for new designs.

**LIFEBUY:** TI has announced that the device will be discontinued, and a lifetime-buy period is in effect.

**NRND:** Not recommended for new designs. Device is in production to support existing customers, but TI does not recommend using this part in a new design.

**PREVIEW:** Device has been announced but is not in production. Samples may or may not be available.

**OBSOLETE:** TI has discontinued the production of the device.

(2) **RoHS:** TI defines "RoHS" to mean semiconductor products that are compliant with the current EU RoHS requirements for all 10 RoHS substances, including the requirement that RoHS substance do not exceed 0.1% by weight in homogeneous materials. Where designed to be soldered at high temperatures, "RoHS" products are suitable for use in specified lead-free processes. TI may reference these types of products as "Pb-Free".

**RoHS Exempt:** TI defines "RoHS Exempt" to mean products that contain lead but are compliant with EU RoHS pursuant to a specific EU RoHS exemption.

**Green:** TI defines "Green" to mean the content of Chlorine (Cl) and Bromine (Br) based flame retardants meet JS709B low halogen requirements of <=1000ppm threshold. Antimony trioxide based flame retardants must also meet the <=1000ppm threshold requirement.

(3) MSL, Peak Temp. - The Moisture Sensitivity Level rating according to the JEDEC industry standard classifications, and peak solder temperature.

(4) There may be additional marking, which relates to the logo, the lot trace code information, or the environmental category on the device.

(5) Multiple Device Markings will be inside parentheses. Only one Device Marking contained in parentheses and separated by a "~" will appear on a device. If a line is indented then it is a continuation of the previous line and the two combined represent the entire Device Marking for that device.

(6) Lead/Ball Finish - Orderable Devices may have multiple material finish options. Finish options are separated by a vertical ruled line. Lead/Ball Finish values may wrap to two lines if the finish value exceeds the maximum column width.

**Important Information and Disclaimer:**The information provided on this page represents TI's knowledge and belief as of the date that it is provided. TI bases its knowledge and belief on information provided by third parties, and makes no representation or warranty as to the accuracy of such information. Efforts are underway to better integrate information from third parties. TI has taken and continues to take reasonable steps to provide representative and accurate information but may not have conducted destructive testing or chemical analysis on incoming materials and chemicals. TI and TI suppliers consider certain information to be proprietary, and thus CAS numbers and other limited information may not be available for release.

In no event shall TI's liability arising out of such information exceed the total purchase price of the TI part(s) at issue in this document sold by TI to Customer on an annual basis.

**OTHER QUALIFIED VERSIONS OF SN54ALS157A, SN54ALS158, SN74ALS157A, SN74ALS158 :**

- Catalog: [SN74ALS157A](#), [SN74ALS158](#)
- Military: [SN54ALS157A](#), [SN54ALS158](#)

NOTE: Qualified Version Definitions:

- Catalog - TI's standard catalog product
- Military - QML certified for Military and Defense Applications

**TAPE AND REEL INFORMATION**

**QUADRANT ASSIGNMENTS FOR PIN 1 ORIENTATION IN TAPE**

\*All dimensions are nominal

| Device         | Package Type | Package Drawing | Pins | SPQ  | Reel Diameter (mm) | Reel Width W1 (mm) | A0 (mm) | B0 (mm) | K0 (mm) | P1 (mm) | W (mm) | Pin1 Quadrant |
|----------------|--------------|-----------------|------|------|--------------------|--------------------|---------|---------|---------|---------|--------|---------------|
| SN74ALS157ADR  | SOIC         | D               | 16   | 2500 | 330.0              | 16.4               | 6.5     | 10.3    | 2.1     | 8.0     | 16.0   | Q1            |
| SN74ALS157ANSR | SO           | NS              | 16   | 2000 | 330.0              | 16.4               | 8.2     | 10.5    | 2.5     | 12.0    | 16.0   | Q1            |
| SN74ALS158NSR  | SO           | NS              | 16   | 2000 | 330.0              | 16.4               | 8.2     | 10.5    | 2.5     | 12.0    | 16.0   | Q1            |

**TAPE AND REEL BOX DIMENSIONS**



\*All dimensions are nominal

| Device         | Package Type | Package Drawing | Pins | SPQ  | Length (mm) | Width (mm) | Height (mm) |
|----------------|--------------|-----------------|------|------|-------------|------------|-------------|
| SN74ALS157ADR  | SOIC         | D               | 16   | 2500 | 333.2       | 345.9      | 28.6        |
| SN74ALS157ANSR | SO           | NS              | 16   | 2000 | 367.0       | 367.0      | 38.0        |
| SN74ALS158NSR  | SO           | NS              | 16   | 2000 | 367.0       | 367.0      | 38.0        |

FK (S-CQCC-N\*\*)

LEADLESS CERAMIC CHIP CARRIER

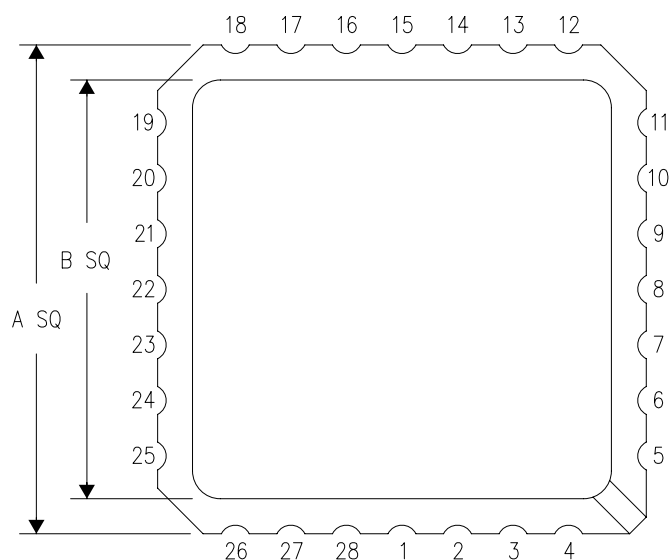
28 TERMINAL SHOWN



| NO. OF TERMINALS ** | A                |                  | B                |                  |
|---------------------|------------------|------------------|------------------|------------------|
|                     | MIN              | MAX              | MIN              | MAX              |
| 20                  | 0.342<br>(8,69)  | 0.358<br>(9,09)  | 0.307<br>(7,80)  | 0.358<br>(9,09)  |
| 28                  | 0.442<br>(11,23) | 0.458<br>(11,63) | 0.406<br>(10,31) | 0.458<br>(11,63) |
| 44                  | 0.640<br>(16,26) | 0.660<br>(16,76) | 0.495<br>(12,58) | 0.560<br>(14,22) |
| 52                  | 0.740<br>(18,78) | 0.761<br>(19,32) | 0.495<br>(12,58) | 0.560<br>(14,22) |
| 68                  | 0.938<br>(23,83) | 0.962<br>(24,43) | 0.850<br>(21,6)  | 0.858<br>(21,8)  |
| 84                  | 1.141<br>(28,99) | 1.165<br>(29,59) | 1.047<br>(26,6)  | 1.063<br>(27,0)  |

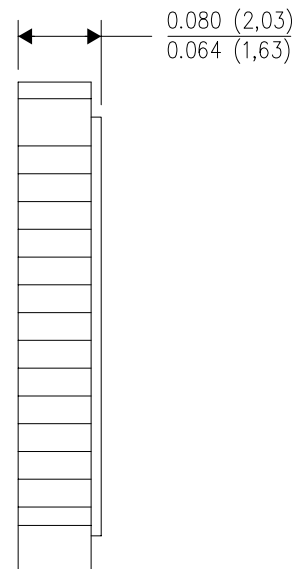
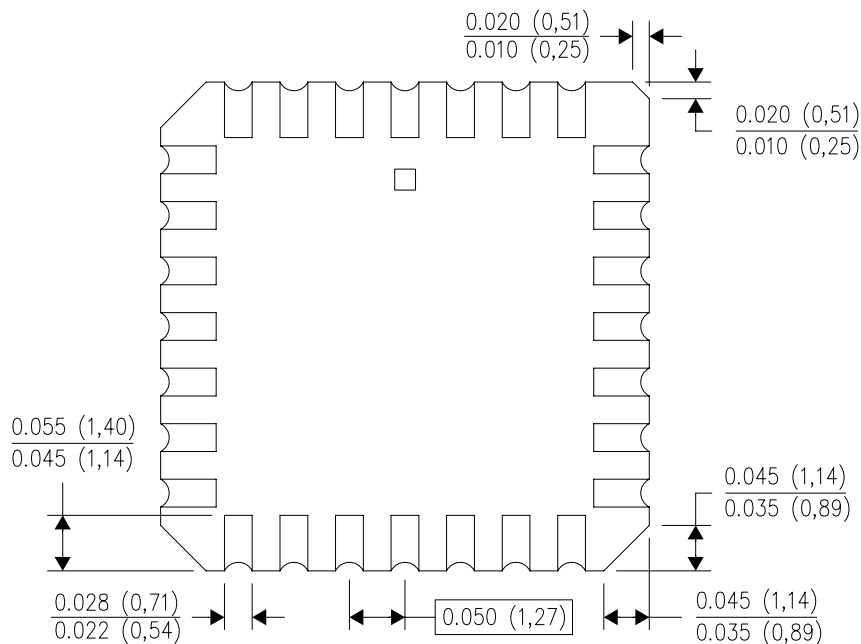

4040140/D 01/11

- NOTES:
- A. All linear dimensions are in inches (millimeters).
  - B. This drawing is subject to change without notice.
  - C. This package can be hermetically sealed with a metal lid.
  - D. Falls within JEDEC MS-004

D (R-PDSO-G16)

PLASTIC SMALL OUTLINE



- NOTES:
- A. All linear dimensions are in inches (millimeters).
  - B. This drawing is subject to change without notice.
  - C. Body length does not include mold flash, protrusions, or gate burrs. Mold flash, protrusions, or gate burrs shall not exceed 0.006 (0,15) each side.
  - D. Body width does not include interlead flash. Interlead flash shall not exceed 0.017 (0,43) each side.
  - E. Reference JEDEC MS-012 variation AC.

D (R-PDSO-G16)

PLASTIC SMALL OUTLINE

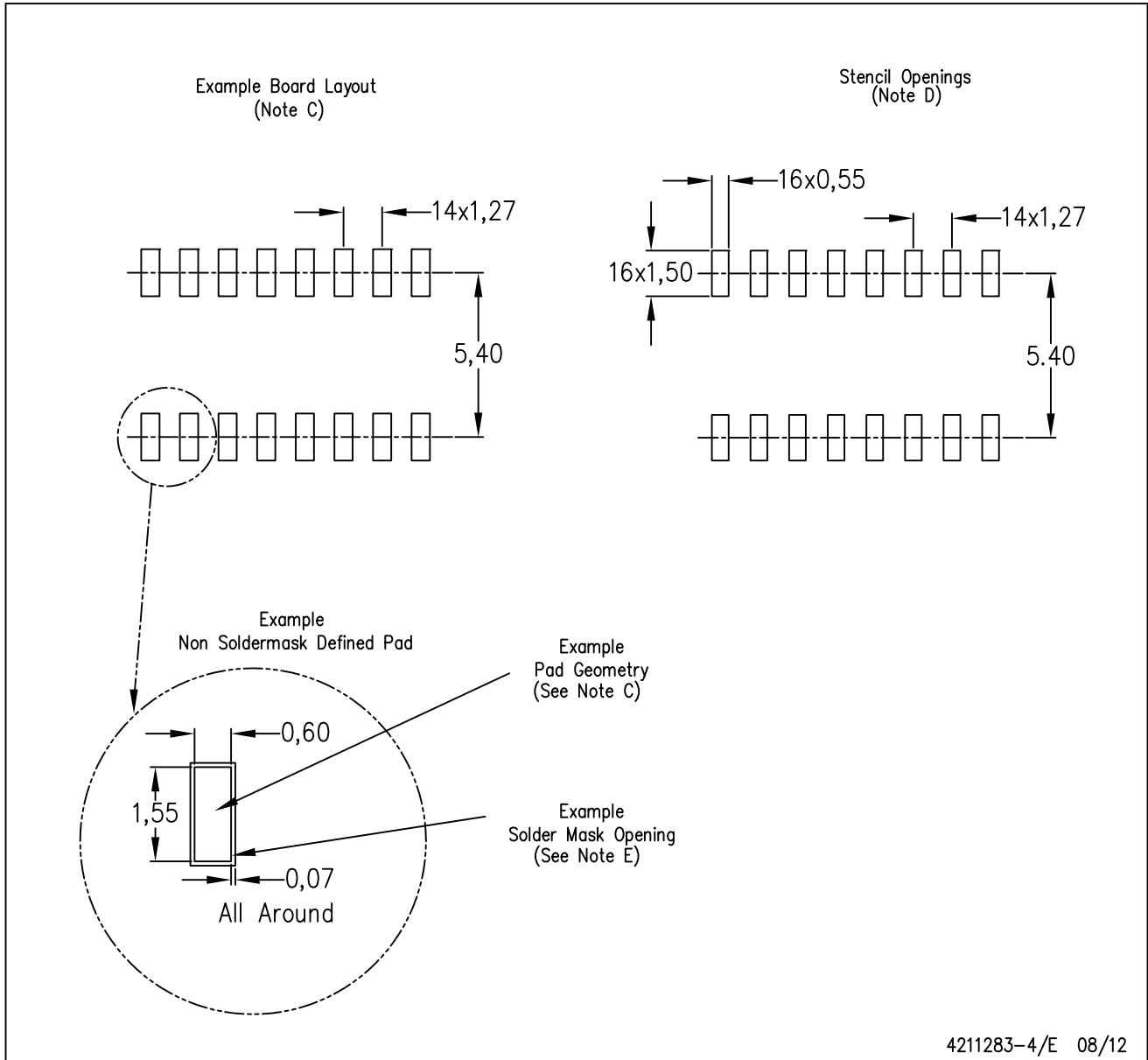

- NOTES:
- All linear dimensions are in millimeters.
  - This drawing is subject to change without notice.
  - Publication IPC-7351 is recommended for alternate designs.
  - Laser cutting apertures with trapezoidal walls and also rounding corners will offer better paste release. Customers should contact their board assembly site for stencil design recommendations. Refer to IPC-7525 for other stencil recommendations.
  - Customers should contact their board fabrication site for solder mask tolerances between and around signal pads.

## MECHANICAL DATA

**NS (R-PDSO-G\*\*)**

**PLASTIC SMALL-OUTLINE PACKAGE**

**14-PINS SHOWN**



- NOTES:
- A. All linear dimensions are in millimeters.
  - B. This drawing is subject to change without notice.
  - C. Body dimensions do not include mold flash or protrusion, not to exceed 0,15.

J (R-GDIP-T\*\*)

14 LEADS SHOWN

CERAMIC DUAL IN-LINE PACKAGE



| DIM \ PINS ** | 14                     | 16                     | 18                     | 20                     |
|---------------|------------------------|------------------------|------------------------|------------------------|
| A             | 0.300<br>(7,62)<br>BSC | 0.300<br>(7,62)<br>BSC | 0.300<br>(7,62)<br>BSC | 0.300<br>(7,62)<br>BSC |
| B MAX         | 0.785<br>(19,94)       | .840<br>(21,34)        | 0.960<br>(24,38)       | 1.060<br>(26,92)       |
| B MIN         | —                      | —                      | —                      | —                      |
| C MAX         | 0.300<br>(7,62)        | 0.300<br>(7,62)        | 0.310<br>(7,87)        | 0.300<br>(7,62)        |
| C MIN         | 0.245<br>(6,22)        | 0.245<br>(6,22)        | 0.220<br>(5,59)        | 0.245<br>(6,22)        |



4040083/F 03/03

- NOTES:
- All linear dimensions are in inches (millimeters).
  - This drawing is subject to change without notice.
  - This package is hermetically sealed with a ceramic lid using glass frit.
  - Index point is provided on cap for terminal identification only on press ceramic glass frit seal only.
  - Falls within MIL STD 1835 GDIP1-T14, GDIP1-T16, GDIP1-T18 and GDIP1-T20.

N (R-PDIP-T\*\*)

PLASTIC DUAL-IN-LINE PACKAGE

16 PINS SHOWN



- NOTES:
- A. All linear dimensions are in inches (millimeters).
  - B. This drawing is subject to change without notice.
  - Falls within JEDEC MS-001, except 18 and 20 pin minimum body length (Dim A).
  - The 20 pin end lead shoulder width is a vendor option, either half or full width.

## IMPORTANT NOTICE

Texas Instruments Incorporated (TI) reserves the right to make corrections, enhancements, improvements and other changes to its semiconductor products and services per JESD46, latest issue, and to discontinue any product or service per JESD48, latest issue. Buyers should obtain the latest relevant information before placing orders and should verify that such information is current and complete.

TI's published terms of sale for semiconductor products (<http://www.ti.com/sc/docs/stdterms.htm>) apply to the sale of packaged integrated circuit products that TI has qualified and released to market. Additional terms may apply to the use or sale of other types of TI products and services.

Reproduction of significant portions of TI information in TI data sheets is permissible only if reproduction is without alteration and is accompanied by all associated warranties, conditions, limitations, and notices. TI is not responsible or liable for such reproduced documentation. Information of third parties may be subject to additional restrictions. Resale of TI products or services with statements different from or beyond the parameters stated by TI for that product or service voids all express and any implied warranties for the associated TI product or service and is an unfair and deceptive business practice. TI is not responsible or liable for any such statements.

Buyers and others who are developing systems that incorporate TI products (collectively, "Designers") understand and agree that Designers remain responsible for using their independent analysis, evaluation and judgment in designing their applications and that Designers have full and exclusive responsibility to assure the safety of Designers' applications and compliance of their applications (and of all TI products used in or for Designers' applications) with all applicable regulations, laws and other applicable requirements. Designer represents that, with respect to their applications, Designer has all the necessary expertise to create and implement safeguards that (1) anticipate dangerous consequences of failures, (2) monitor failures and their consequences, and (3) lessen the likelihood of failures that might cause harm and take appropriate actions. Designer agrees that prior to using or distributing any applications that include TI products, Designer will thoroughly test such applications and the functionality of such TI products as used in such applications.

TI's provision of technical, application or other design advice, quality characterization, reliability data or other services or information, including, but not limited to, reference designs and materials relating to evaluation modules, (collectively, "TI Resources") are intended to assist designers who are developing applications that incorporate TI products; by downloading, accessing or using TI Resources in any way, Designer (individually or, if Designer is acting on behalf of a company, Designer's company) agrees to use any particular TI Resource solely for this purpose and subject to the terms of this Notice.

TI's provision of TI Resources does not expand or otherwise alter TI's applicable published warranties or warranty disclaimers for TI products, and no additional obligations or liabilities arise from TI providing such TI Resources. TI reserves the right to make corrections, enhancements, improvements and other changes to its TI Resources. TI has not conducted any testing other than that specifically described in the published documentation for a particular TI Resource.

Designer is authorized to use, copy and modify any individual TI Resource only in connection with the development of applications that include the TI product(s) identified in such TI Resource. NO OTHER LICENSE, EXPRESS OR IMPLIED, BY ESTOPPEL OR OTHERWISE TO ANY OTHER TI INTELLECTUAL PROPERTY RIGHT, AND NO LICENSE TO ANY TECHNOLOGY OR INTELLECTUAL PROPERTY RIGHT OF TI OR ANY THIRD PARTY IS GRANTED HEREIN, including but not limited to any patent right, copyright, mask work right, or other intellectual property right relating to any combination, machine, or process in which TI products or services are used. Information regarding or referencing third-party products or services does not constitute a license to use such products or services, or a warranty or endorsement thereof. Use of TI Resources may require a license from a third party under the patents or other intellectual property of the third party, or a license from TI under the patents or other intellectual property of TI.

TI RESOURCES ARE PROVIDED "AS IS" AND WITH ALL FAULTS. TI DISCLAIMS ALL OTHER WARRANTIES OR REPRESENTATIONS, EXPRESS OR IMPLIED, REGARDING RESOURCES OR USE THEREOF, INCLUDING BUT NOT LIMITED TO ACCURACY OR COMPLETENESS, TITLE, ANY EPIDEMIC FAILURE WARRANTY AND ANY IMPLIED WARRANTIES OF MERCHANTABILITY, FITNESS FOR A PARTICULAR PURPOSE, AND NON-INFRINGEMENT OF ANY THIRD PARTY INTELLECTUAL PROPERTY RIGHTS. TI SHALL NOT BE LIABLE FOR AND SHALL NOT DEFEND OR INDEMNIFY DESIGNER AGAINST ANY CLAIM, INCLUDING BUT NOT LIMITED TO ANY INFRINGEMENT CLAIM THAT RELATES TO OR IS BASED ON ANY COMBINATION OF PRODUCTS EVEN IF DESCRIBED IN TI RESOURCES OR OTHERWISE. IN NO EVENT SHALL TI BE LIABLE FOR ANY ACTUAL, DIRECT, SPECIAL, COLLATERAL, INDIRECT, PUNITIVE, INCIDENTAL, CONSEQUENTIAL OR EXEMPLARY DAMAGES IN CONNECTION WITH OR ARISING OUT OF TI RESOURCES OR USE THEREOF, AND REGARDLESS OF WHETHER TI HAS BEEN ADVISED OF THE POSSIBILITY OF SUCH DAMAGES.

Unless TI has explicitly designated an individual product as meeting the requirements of a particular industry standard (e.g., ISO/TS 16949 and ISO 26262), TI is not responsible for any failure to meet such industry standard requirements.

Where TI specifically promotes products as facilitating functional safety or as compliant with industry functional safety standards, such products are intended to help enable customers to design and create their own applications that meet applicable functional safety standards and requirements. Using products in an application does not by itself establish any safety features in the application. Designers must ensure compliance with safety-related requirements and standards applicable to their applications. Designer may not use any TI products in life-critical medical equipment unless authorized officers of the parties have executed a special contract specifically governing such use. Life-critical medical equipment is medical equipment where failure of such equipment would cause serious bodily injury or death (e.g., life support, pacemakers, defibrillators, heart pumps, neurostimulators, and implantables). Such equipment includes, without limitation, all medical devices identified by the U.S. Food and Drug Administration as Class III devices and equivalent classifications outside the U.S.

TI may expressly designate certain products as completing a particular qualification (e.g., Q100, Military Grade, or Enhanced Product). Designers agree that it has the necessary expertise to select the product with the appropriate qualification designation for their applications and that proper product selection is at Designers' own risk. Designers are solely responsible for compliance with all legal and regulatory requirements in connection with such selection.

Designer will fully indemnify TI and its representatives against any damages, costs, losses, and/or liabilities arising out of Designer's non-compliance with the terms and provisions of this Notice.

## Looking for pricing, stock, or lifecycle information?

Click below to explore more details on WIN SOURCE:

 [View SN74AS158N on WIN SOURCE](#)

 [Texas Instruments](#) Information

## Optimize Your Supply Chain with WIN SOURCE Solutions

-  Global Sourcing Solution
-  Obsolete Management
-  Cost Control Management
-  Shortage Management
-  Alternative Solution
-  Excess Inventory Management