



**THE DATASHEET OF  
7006L20PFI8**





## Description

The IDT7006 is a high-speed 16K x 8 Dual-Port Static RAM. The IDT7006 is designed to be used as a stand-alone 128K-bit Dual-Port RAM or as a combination MASTER/SLAVE Dual-Port RAM for 16-bit-or-more word systems. Using the IDT MASTER/SLAVE Dual-Port RAM approach in 16-bit or wider memory system applications results in full-speed, error-free operation without the need for additional discrete logic.

This device provides two independent ports with separate control, address, and I/O pins that permit independent, asynchronous access for reads or writes to any location in memory. An automatic power down feature controlled by  $\overline{CE}$  permits the on-chip circuitry of each port to enter

a very low standby power mode.

Fabricated using IDT's CMOS high-performance technology, these devices typically operate on only 750mW of power. Low-power (L) versions offer battery backup data retention capability with typical power consumption of 500 $\mu$ W from a 2V battery.

The IDT7006 is packaged in a ceramic 68-pin PGA, an 68-pin quad flatpack, a PLCC, and a 64-pin thin quad flatpack, TQFP. Military grade product is manufactured in compliance with the latest revision of MIL-PRF-38535 QML, Class B, making it ideally suited to military temperature applications demanding the highest level of performance and reliability.

## Pin Configurations<sup>(1,2,3)</sup>

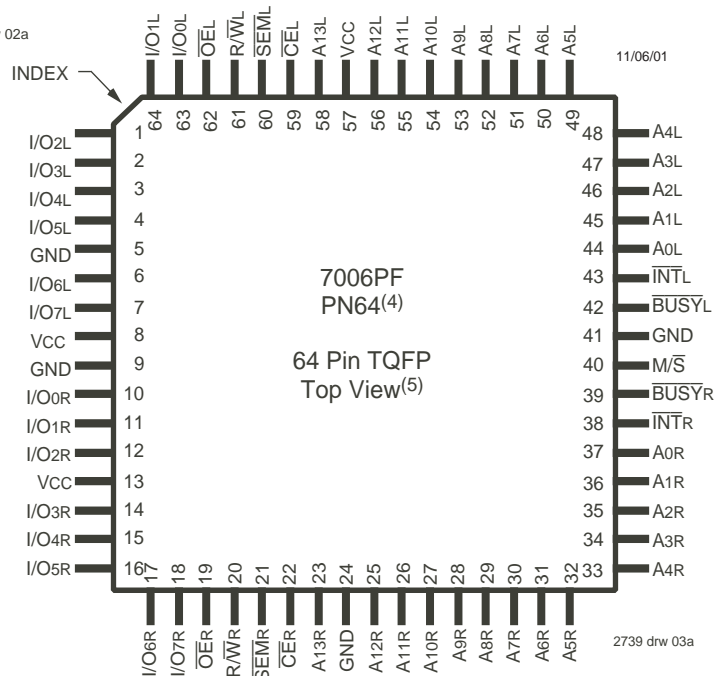
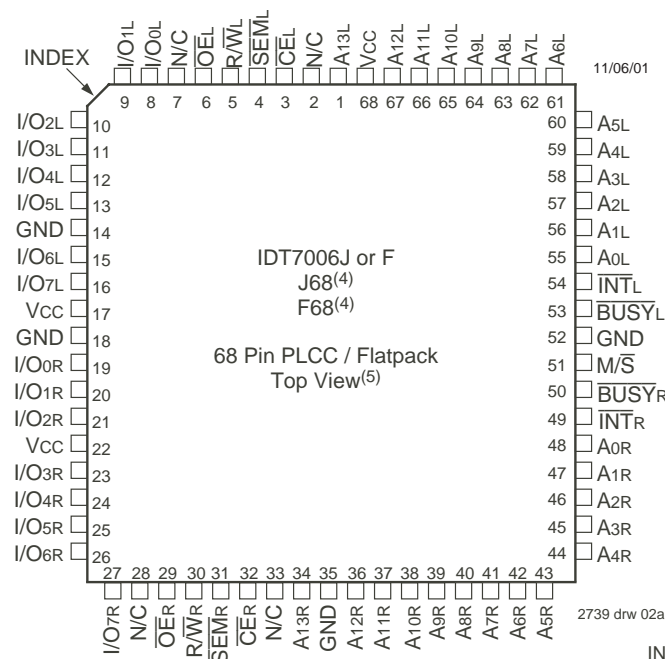

### NOTES:

1. All Vcc pins must be connected to power supply.
2. All GND pins must be connected to ground supply.
3. J68-1 package body is approximately .95 in x .95 in x .17 in.  
F68-1 package body is approximately .97 in x .97 in x .08 in.  
PN64-1 package body is approximately 14mm x 14mm x 1.4mm.
4. This package code is used to reference the package diagram.
5. This text does not indicate orientation of the actual part-marking

Pin Configurations<sup>(1,2,3)</sup> (con't.)

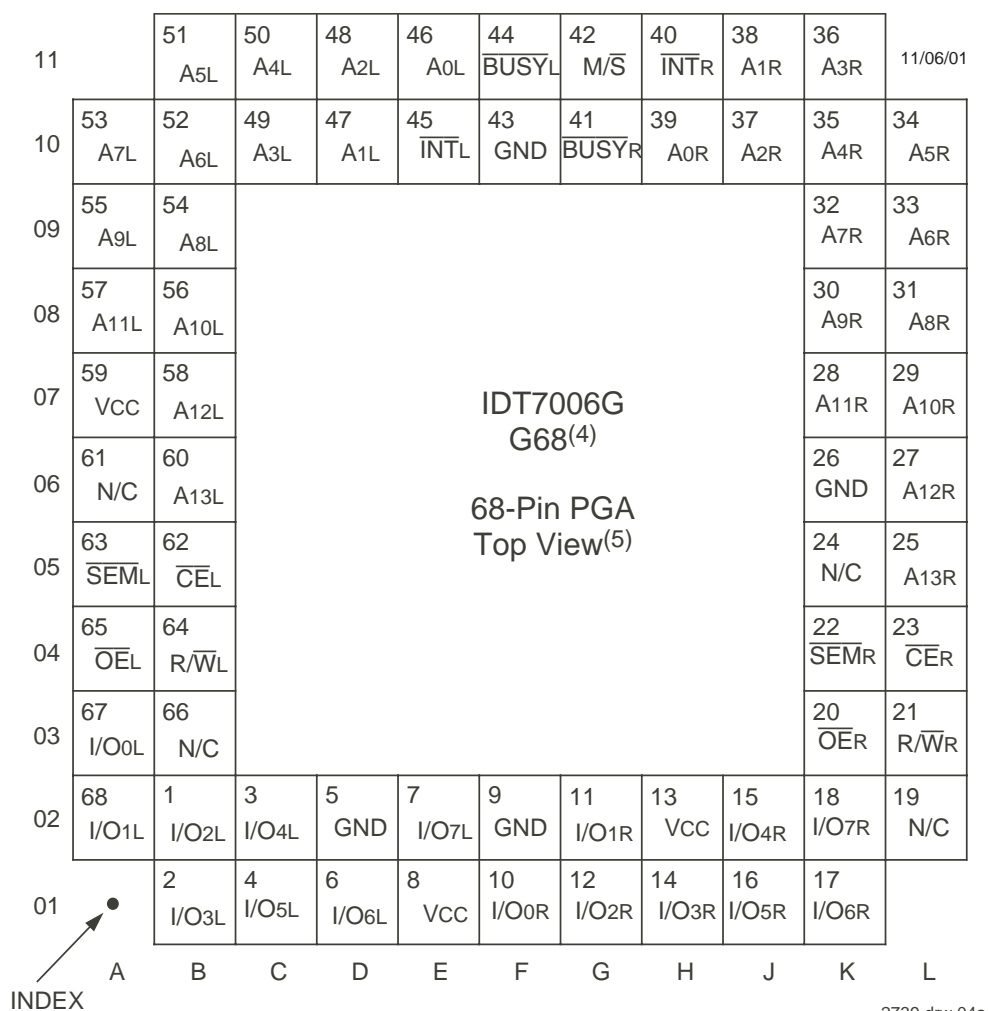

2739 drw 04a

NOTES:

1. All Vcc pins must be connected to power supply.
2. All GND pins must be connected to ground supply.
3. Package body is approximately 1.18 in x 1.18 in x .16 in.
4. This package code is used to reference the package diagram.
5. This text does not indicate orientation of the actual part-marking

Pin Names

Left Port	Right Port	Names
CE <sub>L</sub>	CE <sub>R</sub>	Chip Enable
R/W <sub>L</sub>	R/W <sub>R</sub>	Read/Write Enable
OE <sub>L</sub>	OE <sub>R</sub>	Output Enable
A <sub>0L</sub> - A <sub>13L</sub>	A <sub>0R</sub> - A <sub>13R</sub>	Address
I/O <sub>0L</sub> - I/O <sub>7L</sub>	I/O <sub>0R</sub> - I/O <sub>7R</sub>	Data Input/Output
SEM <sub>L</sub>	SEM <sub>R</sub>	Semaphore Enable
INT <sub>L</sub>	INT <sub>R</sub>	Interrupt Flag
BUSY <sub>L</sub>	BUSY <sub>R</sub>	Busy Flag
	M/S	Master or Slave Select
	Vcc	Power
	GND	Ground

2739 tbl 01

## Truth Table I: Non-Contention Read/Write Control

Inputs <sup>(1)</sup>				Outputs	Mode
$\overline{CE}$	R/ $\overline{W}$	$\overline{OE}$	$\overline{SEM}$	I/O <sub>0-7</sub>	
H	X	X	H	High-Z	Deselected: Power-Down
L	L	X	H	DATA <sub>IN</sub>	Write to Memory
L	H	L	H	DATA <sub>OUT</sub>	Read Memory
X	X	H	X	High-Z	Outputs Disabled

2739 tbl 02

## NOTE:

- A<sub>0L</sub> - A<sub>13L</sub> is not equal to A<sub>0R</sub> - A<sub>13R</sub>

Truth Table II: Semaphore Read/Write Control<sup>(1)</sup>

Inputs <sup>(1)</sup>				Outputs	Mode
$\overline{CE}$	R/ $\overline{W}$	$\overline{OE}$	$\overline{SEM}$	I/O <sub>0-7</sub>	
H	H	L	L	DATA <sub>OUT</sub>	Read in Semaphore Flag Data Out
H	↑	X	L	DATA <sub>IN</sub>	Write I/O <sub>0</sub> into Semaphore Flag
L	X	X	L	—	Not Allowed

2739 tbl 03

## NOTE:

- There are eight semaphore flags written to via I/O<sub>0</sub> and read from I/O<sub>0</sub> - I/O<sub>7</sub>. These eight semaphores are addressed by A<sub>0</sub> - A<sub>7</sub>.

Absolute Maximum Ratings<sup>(1)</sup>

Symbol	Rating	Commercial & Industrial	Military	Unit
V <sub>TERM</sub> <sup>(2)</sup>	Terminal Voltage with Respect to GND	-0.5 to +7.0	-0.5 to +7.0	V
T <sub>BIAS</sub>	Temperature Under Bias	-55 to +125	-65 to +135	°C
T <sub>STG</sub>	Storage Temperature	-65 to +150	-65 to +150	°C
I <sub>OUT</sub>	DC Output Current	50	50	mA

2739 tbl 04

## NOTES:

- Stresses greater than those listed under ABSOLUTE MAXIMUM RATINGS may cause permanent damage to the device. This is a stress rating only and functional operation of the device at these or any other conditions above those indicated in the operational sections of this specification is not implied. Exposure to absolute maximum rating conditions for extended periods may affect reliability.
- V<sub>TERM</sub> must not exceed V<sub>CC</sub> + 10% for more than 25% of the cycle time or 10ns maximum, and is limited to ≤ 20mA for the period of V<sub>TERM</sub> ≤ V<sub>CC</sub> + 10%.

Capacitance<sup>(1)</sup> (T<sub>A</sub> = +25°C, f = 1.0mhz)

Symbol	Parameter	Conditions <sup>(2)</sup>	Max	Unit
C <sub>IN</sub>	Input Capacitance	V <sub>IN</sub> = 3dV	9	pF
C <sub>OUT</sub>	Output Capacitance	V <sub>OUT</sub> = 3dV	10	pF

2739 tbl 05

## NOTES:

- These parameters are determined by device characterization, but are not production tested (TQFP Package Only).
- 3dV references the interpolated capacitance when the input and output signals switch from 0V to 3V or from 3V to 0V.

## Recommended DC Operating Conditions

Symbol	Parameter	Min.	Typ.	Max.	Unit
V <sub>CC</sub>	Supply Voltage	4.5	5.0	5.5	V
GND	Ground	0	0	0	V
V <sub>HI</sub>	Input High Voltage	2.2	—	6.0 <sup>(2)</sup>	V
V <sub>LI</sub>	Input Low Voltage	-0.5 <sup>(1)</sup>	—	0.8	V

2739 tbl 06

## NOTES:

- V<sub>LI</sub> ≥ -1.5V for pulse width less than 10ns.
- V<sub>TERM</sub> must not exceed V<sub>CC</sub> + 10%.

Maximum Operating Temperature and Supply Voltage<sup>(1)</sup>

Grade	Ambient Temperature	GND	V <sub>CC</sub>
Military	-55°C to +125°C	0V	5.0V ± 10%
Commercial	0°C to +70°C	0V	5.0V ± 10%
Industrial	40°C to +85°C	0V	5.0V ± 10%

2739 tbl 07

## NOTES:

- This is the parameter T<sub>A</sub>. This is the "instant on" case temperature.

DC Electrical Characteristics Over the Operating Temperature and Supply Voltage Range ( $V_{CC} = 5.0V \pm 10\%$ )

Symbol	Parameter	Test Conditions	7006S		7006L		Unit
			Min.	Max.	Min.	Max.	
$ I_{LI} $	Input Leakage Current <sup>(1)</sup>	$V_{CC} = 5.5V, V_{IN} = 0V \text{ to } V_{CC}$	—	10	—	5	$\mu A$
$ I_{LO} $	Output Leakage Current	$\overline{CE} = V_{IH}, V_{OUT} = 0V \text{ to } V_{CC}$	—	10	—	5	$\mu A$
$V_{OL}$	Output Low Voltage	$I_{OL} = 4mA$	—	0.4	—	0.4	V
$V_{OH}$	Output High Voltage	$I_{OH} = -4mA$	2.4	—	2.4	—	V

2739 tbl 08

NOTE:

- At  $V_{CC} \leq 2.0V$  input leakages are undefined.

Data Retention Characteristics Over All Temperature Ranges (L Version Only) ( $V_{LC} = 0.2V, V_{HC} = V_{CC} - 0.2V$ )

Symbol	Parameter	Test Condition	Min.	Typ. <sup>(1)</sup>	Max.	Unit
$V_{DR}$	$V_{CC}$ for Data Retention	$V_{CC} = 2V$	2.0	—	—	V
$I_{CCDR}$	Data Retention Current	$\overline{CE} \geq V_{HC}$ $V_{IN} \geq V_{HC} \text{ or } \leq V_{LC}$	Mil. & Ind. — Com'l. —	100	4000 1500	$\mu A$
$t_{CDR}^{(2)}$	Chip Deselect to Data Retention Time	$\overline{SEM} \geq V_{HC}$	0	—	—	ns
$t_{r}^{(3)}$	Operation Recovery Time		$t_{rc}^{(2)}$	—	—	ns

2739 tbl 09

NOTES:

- $T_A = +25^\circ C, V_{CC} = 2V$ , and are not production tested.
- $t_{rc}$  = Read Cycle Time
- This parameter is guaranteed by characterization, but is not production tested.

Data Retention Waveform

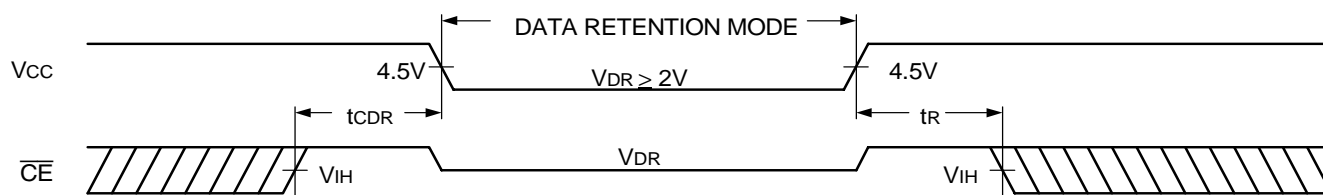

2739 drw 05

### DC Electrical Characteristics Over the Operating Temperature and Supply Voltage Range<sup>(1)</sup> (V<sub>CC</sub> = 5.0V ± 10%)

Symbol	Parameter	Test Condition	Version	7006X15 Com'l Only		7006X17 Com'l Only		7006X20 Com'l, Ind & Military		7006X25 Com'l & Military		Unit	
				Typ. <sup>(2)</sup>	Max.	Typ. <sup>(2)</sup>	Max.	Typ. <sup>(2)</sup>	Max.	Typ. <sup>(2)</sup>	Max.		
I <sub>CC</sub>	Dynamic Operating Current (Both Ports Active)	$\overline{CE} = V_{IL}$ , Outputs Disabled $SEM = V_{IH}$ $f = f_{MAX}^{(3)}$	COM'L	S	170	310	170	310	160	290	155	265	mA
				L	160	260	160	260	150	240	145	220	
ISB1	Standby Current (Both Ports - TTL Level Inputs)	$\overline{CE} = \overline{CE} = V_{IH}$ $SEMR = SEML = V_{IH}$ $f = f_{MAX}^{(3)}$	COM'L	S	20	60	20	60	20	60	16	60	mA
				L	10	50	10	50	10	50	10	50	
ISB2	Standby Current (One Port - TTL Level Inputs)	$\overline{CE}^A = V_{IL}$ and $\overline{CE}^B = V_{IH}^{(6)}$ Active Port Outputs Disabled, $f = f_{MAX}^{(3)}$ $SEMR = SEML = V_{IH}$	COM'L	S	105	190	105	190	95	180	90	170	mA
				L	95	160	95	160	85	150	80	140	
ISB3	Full Standby Current (Both Ports - All CMOS Level Inputs)	Both Ports $\overline{CE}$ and $\overline{CE} \geq V_{CC} - 0.2V$ $V_{IN} \geq V_{CC} - 0.2V$ or $V_{IN} < 0.2V$ , $f = 0^{(4)}$ $SEMR = SEML \geq V_{CC} - 0.2V$	COM'L	S	1.0	15	1.0	15	1.0	15	1.0	15	mA
				L	0.2	5	0.2	5	0.2	5	0.2	5	
ISB4	Full Standby Current (One Port - All CMOS Level Inputs)	$\overline{CE}^A \leq 0.2V$ and $\overline{CE}^B \geq V_{CC} - 0.2V^{(6)}$ $SEMR = SEML \geq V_{CC} - 0.2V$ $V_{IN} \geq V_{CC} - 0.2V$ or $V_{IN} < 0.2V$ Active Port Outputs Disabled $f = f_{MAX}^{(3)}$	COM'L	S	100	170	100	170	90	155	85	145	mA
				L	90	140	90	140	80	130	75	120	
			MIL & IND	S	—	—	—	—	160	370	155	340	
				L	—	—	—	—	150	320	145	280	
			MIL & IND	S	—	—	—	—	20	90	16	80	
				L	—	—	—	—	10	70	10	65	
			MIL & IND	S	—	—	—	—	95	240	90	215	
				L	—	—	—	—	85	210	80	180	
			MIL & IND	S	—	—	—	—	1.0	30	1.0	30	
				L	—	—	—	—	0.2	10	0.2	10	
			MIL & IND	S	—	—	—	—	90	225	85	200	
				L	—	—	—	—	80	200	75	170	

2739 tbl 10

Symbol	Parameter	Test Condition	Version	7006X35 Com'l & Military		7006X55 Com'l, Ind & Military		7006X70 Military Only		Unit	
				Typ. <sup>(2)</sup>	Max.	Typ. <sup>(2)</sup>	Max.	Typ. <sup>(2)</sup>	Max.		
I <sub>CC</sub>	Dynamic Operating Current (Both Ports Active)	$\overline{CE} = V_{IL}$ , Outputs Disabled $SEM = V_{IH}$ $f = f_{MAX}^{(3)}$	COM'L	S	150	250	150	250	—	—	mA
				L	140	210	140	210	—	—	
ISB1	Standby Current (Both Ports - TTL Level Inputs)	$\overline{CE} = \overline{CE} = V_{IH}$ $SEMR = SEML = V_{IH}$ $f = f_{MAX}^{(3)}$	COM'L	S	13	60	13	60	—	—	mA
				L	10	50	10	50	—	—	
ISB2	Standby Current (One Port - TTL Level Inputs)	$\overline{CE}^A = V_{IL}$ and $\overline{CE}^B = V_{IH}^{(6)}$ Active Port Outputs Disabled, $f = f_{MAX}^{(3)}$ $SEMR = SEML = V_{IH}$	COM'L	S	85	155	85	155	—	—	mA
				L	75	130	75	130	—	—	
ISB3	Full Standby Current (Both Ports - All CMOS Level Inputs)	Both Ports $\overline{CE}$ and $\overline{CE} \geq V_{CC} - 0.2V$ $V_{IN} \geq V_{CC} - 0.2V$ or $V_{IN} < 0.2V$ , $f = 0^{(4)}$ $SEMR = SEML \geq V_{CC} - 0.2V$	COM'L	S	1.0	15	1.0	15	—	—	mA
				L	0.2	5	0.2	5	—	—	
ISB4	Full Standby Current (One Port - All CMOS Level Inputs)	$\overline{CE}^A \leq 0.2V$ and $\overline{CE}^B \geq V_{CC} - 0.2V^{(6)}$ $SEMR = SEML \geq V_{CC} - 0.2V$ $V_{IN} \geq V_{CC} - 0.2V$ or $V_{IN} < 0.2V$ Active Port Outputs Disabled $f = f_{MAX}^{(3)}$	COM'L	S	80	135	80	135	—	—	mA
				L	70	110	70	110	—	—	
			MIL & IND	S	—	—	—	—	—		
				L	—	—	—	—	—		
			MIL & IND	S	80	175	80	175	75	175	
				L	70	150	70	150	65	150	

2739 tbl 11

**NOTES:**

- 'X' in part numbers indicates power rating (S or L)
- V<sub>CC</sub> = 5V, T<sub>A</sub> = +25°C, and are not production tested. I<sub>CC</sub> DC = 120ma (typ)
- At f = f<sub>MAX</sub>, address and I/O's are cycling at the maximum frequency read cycle of 1/trc, and using "AC Test Conditions" of input levels of GND to 3V.
- f = 0 means no address or control lines change.
- Port "A" may be either left or right port. Port "B" is the opposite from port "A".

## AC Test Conditions

Input Pulse Levels	GND to 3.0V
Input Rise/Fall Times	5ns Max.
Input Timing Reference Levels	1.5V
Output Reference Levels	1.5V
Output Load	Figures 1 and 2

2739 tbl 12

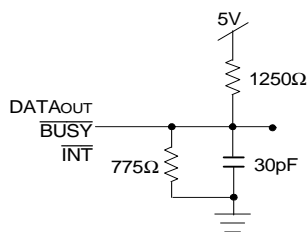
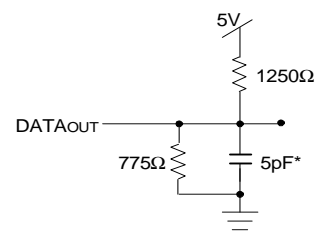

Figure 1. AC Output Test Load



2739 drw 06

Figure 2. Output Test Load  
(5pF for tLZ, tHZ, tWZ, tOW)  
\*Including scope and jig.

## AC Electrical Characteristics Over the Operating temperature and Supply Voltage Range<sup>(4)</sup>

Symbol	Parameter	7006X15 Com'l Only		7006X17 Com'l Only		7006X20 Com'l, Ind & Military		7006X25 Com'l & Military		Unit
		Min.	Max.	Min.	Max.	Min.	Max.	Min.	Max.	
<b>READ CYCLE</b>										
t <sub>RC</sub>	Read Cycle Time	15	—	17	—	20	—	25	—	ns
t <sub>AA</sub>	Address Access Time	—	15	—	17	—	20	—	25	ns
t <sub>ACE</sub>	Chip Enable Access Time <sup>(3)</sup>	—	15	—	17	—	20	—	25	ns
t <sub>AOE</sub>	Output Enable Access Time	—	10	—	10	—	12	—	13	ns
t <sub>OH</sub>	Output Hold from Address Change	3	—	3	—	3	—	3	—	ns
t <sub>LZ</sub>	Output Low-Z Time <sup>(1,2)</sup>	3	—	3	—	3	—	3	—	ns
t <sub>HZ</sub>	Output High-Z Time <sup>(1,2)</sup>	—	10	—	10	—	12	—	15	ns
t <sub>PU</sub>	Chip Enable to Power Up Time <sup>(2,5)</sup>	0	—	0	—	0	—	0	—	ns
t <sub>PD</sub>	Chip Disable to Power Down Time <sup>(2,5)</sup>	—	15	—	17	—	20	—	25	ns
t <sub>SOP</sub>	Semaphore Flag Update Pulse ( $\overline{OE}$ or $\overline{SEM}$ )	10	—	10	—	10	—	10	—	ns
t <sub>SAA</sub>	Semaphore Address Access Time	—	15	—	17	—	20	—	25	ns

2739 tbl 13a

Symbol	Parameter	7006X35 Com'l & Military		7006X55 Com'l, Ind & Military		7006X70 Military Only		Unit
		Min.	Max.	Min.	Max.	Min.	Max.	
<b>READ CYCLE</b>								
t <sub>RC</sub>	Read Cycle Time	35	—	55	—	70	—	ns
t <sub>AA</sub>	Address Access Time	—	35	—	55	—	70	ns
t <sub>ACE</sub>	Chip Enable Access Time <sup>(3)</sup>	—	35	—	55	—	70	ns
t <sub>AOE</sub>	Output Enable Access Time	—	20	—	30	—	35	ns
t <sub>OH</sub>	Output Hold from Address Change	3	—	3	—	3	—	ns
t <sub>LZ</sub>	Output Low-Z Time <sup>(1,2)</sup>	3	—	3	—	3	—	ns
t <sub>HZ</sub>	Output High-Z Time <sup>(1,2)</sup>	—	15	—	25	—	30	ns
t <sub>PU</sub>	Chip Enable to Power Up Time <sup>(2,5)</sup>	0	—	0	—	0	—	ns
t <sub>PD</sub>	Chip Disable to Power Down Time <sup>(2,5)</sup>	—	35	—	50	—	50	ns
t <sub>SOP</sub>	Semaphore Flag Update Pulse ( $\overline{OE}$ or $\overline{SEM}$ )	15	—	15	—	15	—	ns
t <sub>SAA</sub>	Semaphore Address Access Time	—	35	—	55	—	70	ns

2739 tbl 13b

### NOTES:

1. Transition is measured 0mV from Low or High-impedance voltage with load (Figures 1 and 2).
2. This parameter is guaranteed by device characterization, but is not production tested.
3. To access RAM,  $\overline{CE} = V_{IL}$  and  $\overline{SEM} = V_{IH}$ . To access semaphore,  $\overline{CE} = V_{IH}$  and  $\overline{SEM} = V_{IL}$ .
4. 'X' in part numbers indicates power rating (S or L).

### Waveform of Read Cycles<sup>(5)</sup>

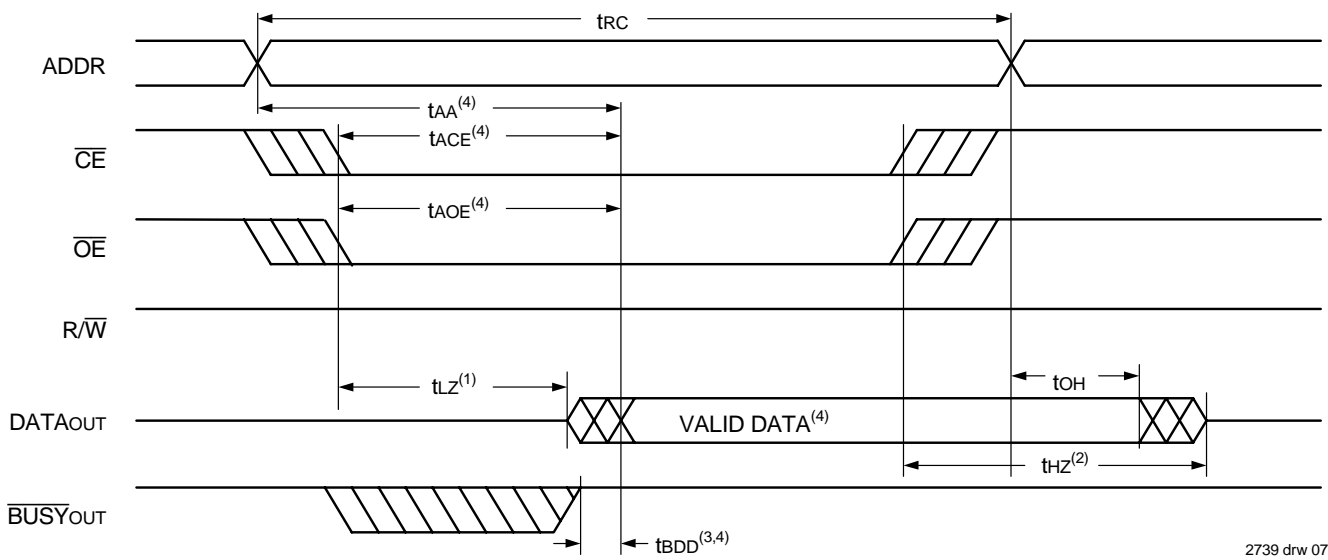

2739 drw 07

#### NOTES:

1. Timing depends on which signal is asserted last,  $\overline{OE}$  or  $\overline{CE}$ .
2. Timing depends on which signal is de-asserted first  $\overline{CE}$  or  $\overline{OE}$ .
3. t<sub>BDD</sub> delay is required only in cases where the opposite port is completing a write operation to the same address location. For simultaneous read operations  $\overline{BUSY}$  has no relation to valid output data.
4. Start of valid data depends on which timing becomes effective last t<sub>AOE</sub>, t<sub>ACE</sub>, t<sub>AA</sub> or t<sub>BDD</sub>.
5.  $\overline{SEM} = V_{IH}$ .

### Timing of Power-Up Power-Down

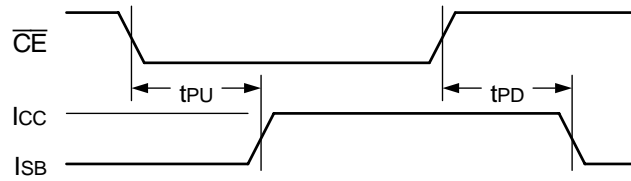

2739 drw 08

## AC Electrical Characteristics Over the Operating Temperature and Supply Voltage<sup>(5)</sup>

Symbol	Parameter	7006X15 Com'l Only		7006X17 Com'l Only		7006X20 Com'l, Ind & Military		7006X25 Com'l & Military		Unit
		Min.	Max.	Min.	Max.	Min.	Max.	Min.	Max.	
<b>WRITE CYCLE</b>										
t <sub>WC</sub>	Write Cycle Time	15	—	17	—	20	—	25	—	ns
t <sub>EW</sub>	Chip Enable to End-of-Write <sup>(6)</sup>	12	—	12	—	15	—	20	—	ns
t <sub>AW</sub>	Address Valid to End-of-Write	12	—	12	—	15	—	20	—	ns
t <sub>AS</sub>	Address Set-up Time <sup>(6)</sup>	0	—	0	—	0	—	0	—	ns
t <sub>WP</sub>	Write Pulse Width	12	—	12	—	15	—	20	—	ns
t <sub>WR</sub>	Write Recovery Time	0	—	0	—	0	—	0	—	ns
t <sub>DW</sub>	Data Valid to End-of-Write	10	—	10	—	15	—	15	—	ns
t <sub>HZ</sub>	Output High-Z Time <sup>(1,2)</sup>	—	10	—	10	—	12	—	15	ns
t <sub>DH</sub>	Data Hold Time <sup>(4)</sup>	0	—	0	—	0	—	0	—	ns
t <sub>WZ</sub>	Write Enable to Output in High-Z <sup>(1,2)</sup>	—	—	—	—	—	12	—	15	ns
t <sub>OW</sub>	Output Active from End-of-Write <sup>(1,2,4)</sup>	0	—	0	—	0	—	0	—	ns
t <sub>SWRD</sub>	$\overline{\text{SEM}}$ Flag Write to Read Time	5	—	5	—	5	—	5	—	ns
t <sub>SPS</sub>	$\overline{\text{SEM}}$ Flag Contention Window	5	—	5	—	5	—	5	—	ns

2739 tbl 14a

Symbol	Parameter	7006X35 Com'l & Military		7006X55 Com'l, Ind & Military		7006X70 Military Only		Unit
		Min.	Max.	Min.	Max.	Min.	Max.	
<b>WRITE CYCLE</b>								
t <sub>WC</sub>	Write Cycle Time	35	—	55	—	70	—	ns
t <sub>EW</sub>	Chip Enable to End-of-Write <sup>(6)</sup>	30	—	45	—	50	—	ns
t <sub>AW</sub>	Address Valid to End-of-Write	30	—	45	—	50	—	ns
t <sub>AS</sub>	Address Set-up Time <sup>(6)</sup>	0	—	0	—	0	—	ns
t <sub>WP</sub>	Write Pulse Width	25	—	40	—	50	—	ns
t <sub>WR</sub>	Write Recovery Time	0	—	0	—	0	—	ns
t <sub>DW</sub>	Data Valid to End-of-Write	15	—	30	—	40	—	ns
t <sub>HZ</sub>	Output High-Z Time <sup>(1,2)</sup>	—	15	—	25	—	30	ns
t <sub>DH</sub>	Data Hold Time <sup>(4)</sup>	0	—	0	—	0	—	ns
t <sub>WZ</sub>	Write Enable to Output in High-Z <sup>(1,2)</sup>	—	15	—	25	—	30	ns
t <sub>OW</sub>	Output Active from End-of-Write <sup>(1,2,4)</sup>	0	—	0	—	0	—	ns
t <sub>SWRD</sub>	$\overline{\text{SEM}}$ Flag Write to Read Time	5	—	5	—	5	—	ns
t <sub>SPS</sub>	$\overline{\text{SEM}}$ Flag Contention Window	5	—	5	—	5	—	ns

2739 tbl 14b

### NOTES:

1. Transition is measured 0mV from Low or High-impedance voltage with load (Figure 2).
2. This parameter is guaranteed by device characterization, but is not production tested but not tested.
3. To access RAM,  $\overline{\text{CE}} = \text{V}_{\text{IL}}$ ,  $\overline{\text{SEM}} = \text{V}_{\text{IH}}$ . To access semaphore,  $\overline{\text{CE}} = \text{V}_{\text{IH}}$  and  $\overline{\text{SEM}} = \text{V}_{\text{IL}}$ . Either condition must be valid for the entire t<sub>ew</sub> time.
4. The specification for t<sub>DH</sub> must be met by the device supplying write data to the RAM under all operating conditions. Although t<sub>DH</sub> and t<sub>ow</sub> values will vary over voltage and temperature, the actual t<sub>DH</sub> will always be smaller than the actual t<sub>ow</sub>.
5. 'X' in part numbers indicates power rating (S or L).

### Timing Waveform of Write Cycle No. 1, R/W Controlled Timing<sup>(1,5,8)</sup>

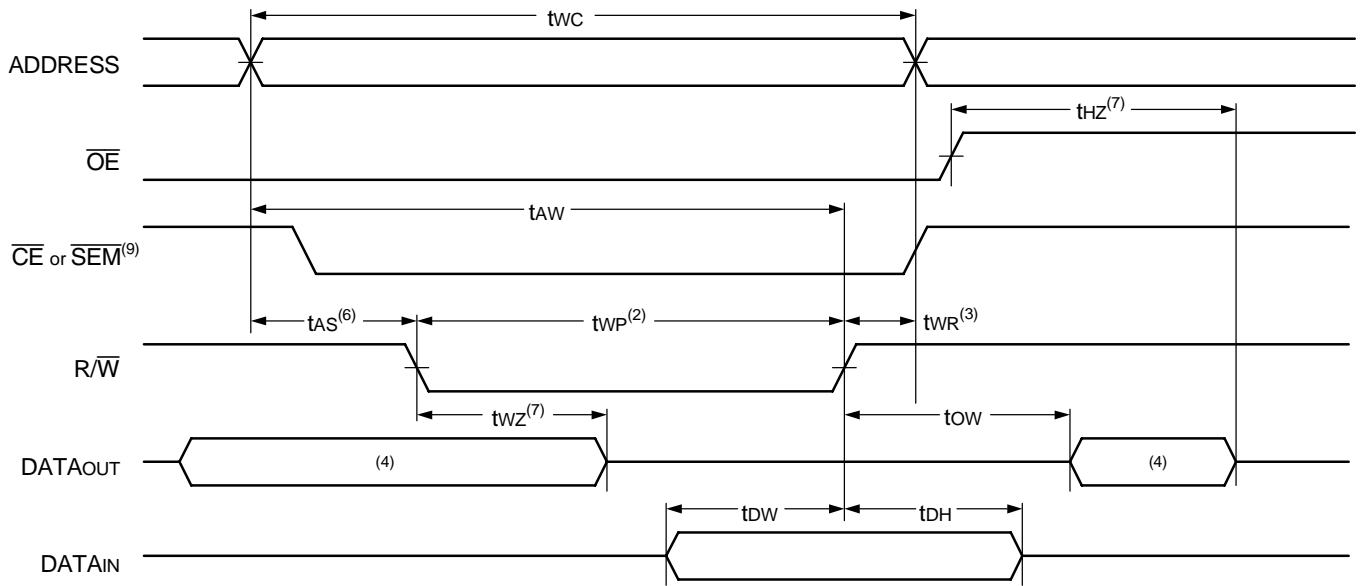

2739 drw 09

### Timing Waveform of Write Cycle No. 2, CE Controlled Timing<sup>(1,5)</sup>

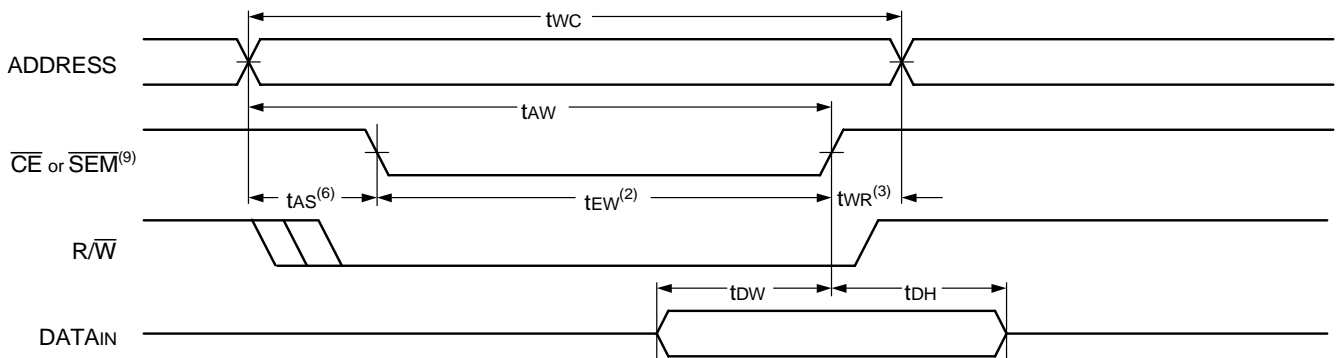

2739 drw 10

**NOTES:**

1. R/W or CE must be HIGH during all address transitions.
2. A write occurs during the overlap (tEW or twp) of a LOW CE and a LOW R/W for memory array writing cycle.
3. tWR is measured from the earlier of CE or R/W (or SEM or R/W) going HIGH to the end of write cycle.
4. During this period, the I/O pins are in the output state and input signals must not be applied.
5. If the CE or SEM LOW transition occurs simultaneously with or after the R/W low transition, the outputs remain in the High-impedance state.
6. Timing depends on which enable signal is asserted last, CE or R/W.
7. This parameter is guaranteed by device characterization, but is not production tested. Transition is measured by 0mV from steady state with the Output Test Load (Figure 2).
8. If OE is LOW during R/W controlled write cycle, the write pulse width must be the larger of twp or (twz + tow) to allow the I/O drivers to turn off and data to be placed on the bus for the required tdw. If OE is HIGH during an R/W controlled write cycle, this requirement does not apply and the write pulse can be as short as the specified twp.
9. To access RAM, CE = VIL and SEM = VIH. To access semaphore CE = VIH and SEM = VIL. tEW must be met for either condition.

### Timing Waveform of Semaphore Read after Write Timing, Either Side<sup>(1)</sup>

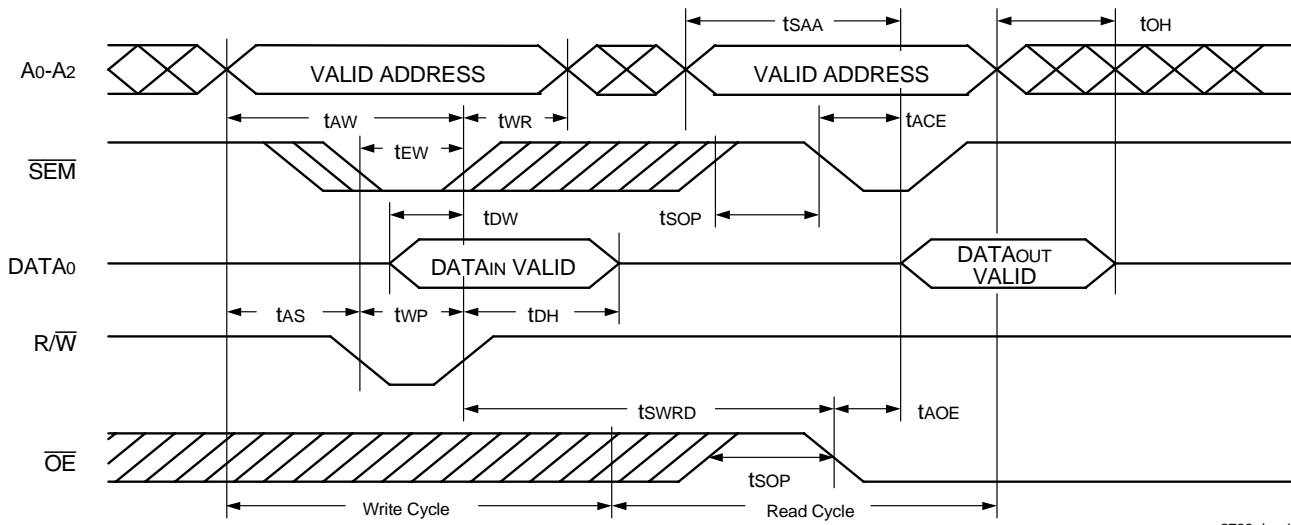

2739 drw 11

**NOTE:**

1.  $\overline{CE} = V_{IH}$  for the duration of the above timing (both write and read cycle).

### Timing Waveform of Semaphore Write Contention<sup>(1,3,4)</sup>

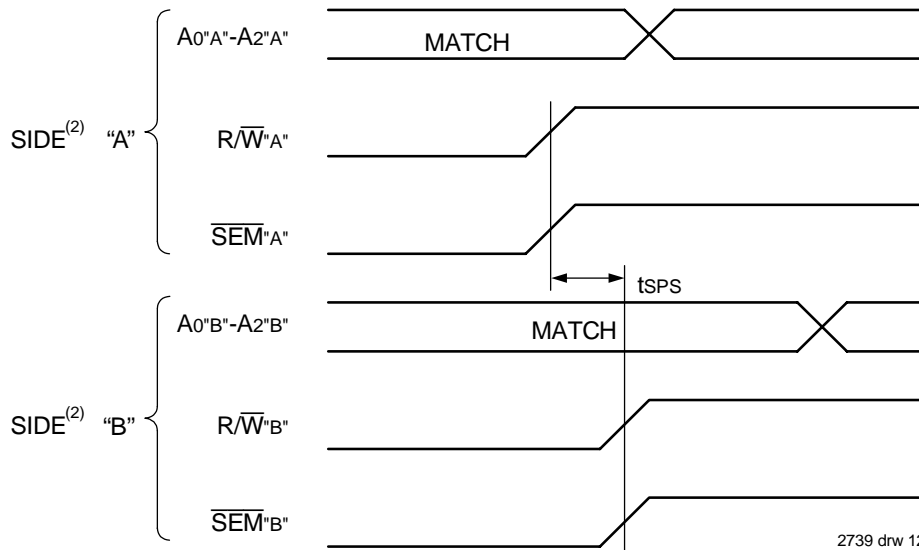

2739 drw 12

**NOTES:**

1.  $D_{OR} = D_{OL} = V_{IL}$ ,  $\overline{CE}_R = \overline{CE}_L = V_{IH}$ , Semaphore Flag is released from both sides (reads as ones from both sides) at cycle start.
2. All timing is the same for left and right ports. Port "A" may be either left or right port. Port "B" is the opposite from port "A".
3. This parameter is measured from  $R/\overline{W}^A$  or  $\overline{SEM}^A$  going HIGH to  $R/\overline{W}^B$  or  $\overline{SEM}^B$  going HIGH.
4. If  $t_{SPS}$  is not satisfied, the semaphore will fall positively to one side or the other, but there is no guarantee which side will obtain the flag.

## AC Electrical Characteristics Over the Operating Temperature and Supply Voltage Range<sup>(6)</sup>

Symbol	Parameter	7006X15 Com'l Only		7006X17 Com'l Only		7006X20 Com'l, Ind & Military		7006X25 Com'l & Military		Unit
		Min.	Max.	Min.	Max.	Min.	Max.	Min.	Max.	
<b>BUSY TIMING (M/S=V<sub>IH</sub>)</b>										
t <sub>BAA</sub>	$\overline{\text{BUSY}}$ Access Time from Address Match	—	15	—	17	—	20	—	20	ns
t <sub>BDA</sub>	$\overline{\text{BUSY}}$ Disable Time from Address Not Matched	—	15	—	17	—	20	—	20	ns
t <sub>BAC</sub>	$\overline{\text{BUSY}}$ Access Time from Chip Enable Low	—	15	—	17	—	20	—	20	ns
t <sub>BDC</sub>	$\overline{\text{BUSY}}$ Access Time from Chip Enable High	—	15	—	17	—	17	—	17	ns
t <sub>APS</sub>	Arbitration Priority Set-up Time <sup>(2)</sup>	5	—	5	—	5	—	5	—	ns
t <sub>BDD</sub>	$\overline{\text{BUSY}}$ Disable to Valid Data <sup>(3)</sup>	—	18	—	18	—	30	—	30	ns
t <sub>WH</sub>	Write Hold After $\overline{\text{BUSY}}$ <sup>(6)</sup>	12	—	13	—	15	—	17	—	ns
<b>BUSY TIMING (M/S=V<sub>IL</sub>)</b>										
t <sub>WB</sub>	$\overline{\text{BUSY}}$ Input to Write <sup>(4)</sup>	0	—	0	—	0	—	0	—	ns
t <sub>WH</sub>	Write Hold After $\overline{\text{BUSY}}$ <sup>(6)</sup>	12	—	13	—	15	—	17	—	ns
<b>PORT-TO-PORT DELAY TIMING</b>										
t <sub>WDD</sub>	Write Pulse to Data Delay <sup>(1)</sup>	—	30	—	30	—	45	—	50	ns
t <sub>DDD</sub>	Write Data Valid to Read Data Delay <sup>(1)</sup>	—	25	—	25	—	35	—	35	ns

2739 tbl 15a

Symbol	Parameter	7006X35 Com'l & Military		7006X55 Com'l, Ind & Military		7006X70 Military Only		Unit
		Min.	Max.	Min.	Max.	Min.	Max.	
<b>BUSY TIMING (M/S=V<sub>IH</sub>)</b>								
t <sub>BAA</sub>	$\overline{\text{BUSY}}$ Access Time from Address Match	—	20	—	45	—	45	ns
t <sub>BDA</sub>	$\overline{\text{BUSY}}$ Disable Time from Address Not Matched	—	20	—	40	—	40	ns
t <sub>BAC</sub>	$\overline{\text{BUSY}}$ Access Time from Chip Enable Low	—	20	—	40	—	40	ns
t <sub>BDC</sub>	$\overline{\text{BUSY}}$ Access Time from Chip Enable High	—	20	—	35	—	35	ns
t <sub>APS</sub>	Arbitration Priority Set-up Time <sup>(2)</sup>	5	—	5	—	5	—	ns
t <sub>BDD</sub>	$\overline{\text{BUSY}}$ Disable to Valid Data <sup>(3)</sup>	—	35	—	40	—	45	ns
t <sub>WH</sub>	Write Hold After $\overline{\text{BUSY}}$ <sup>(6)</sup>	25	—	25	—	25	—	ns
<b>BUSY TIMING (M/S=V<sub>IL</sub>)</b>								
t <sub>WB</sub>	$\overline{\text{BUSY}}$ Input to Write <sup>(4)</sup>	0	—	0	—	0	—	ns
t <sub>WH</sub>	Write Hold After $\overline{\text{BUSY}}$ <sup>(6)</sup>	25	—	25	—	25	—	ns
<b>PORT-TO-PORT DELAY TIMING</b>								
t <sub>WDD</sub>	Write Pulse to Data Delay <sup>(1)</sup>	—	60	—	80	—	95	ns
t <sub>DDD</sub>	Write Data Valid to Read Data Delay <sup>(1)</sup>	—	45	—	65	—	80	ns

2739 tbl 15b

**NOTES:**

- Port-to-port delay through RAM cells from writing port to reading port, refer to "Timing Waveform of Write with Port-to-Port Read and  $\overline{\text{BUSY}}$ ".
- To ensure that the earlier of the two ports wins.
- t<sub>BDD</sub> is a calculated parameter and is the greater of 0, t<sub>WDD</sub> – t<sub>WP</sub> (actual) or t<sub>DDD</sub> – t<sub>DW</sub> (actual).
- To ensure that the write cycle is inhibited with port "B" during contention on port "A".
- To ensure that a write cycle is completed on port "B" after contention with port "A".
- 'X' is part numbers indicates power rating (S or L).

Timing Waveform of Write with Port-to-Port Read and **BUSY**<sup>(2,5)</sup> ( $M/\bar{S} = V_{IH}$ )<sup>(4)</sup>

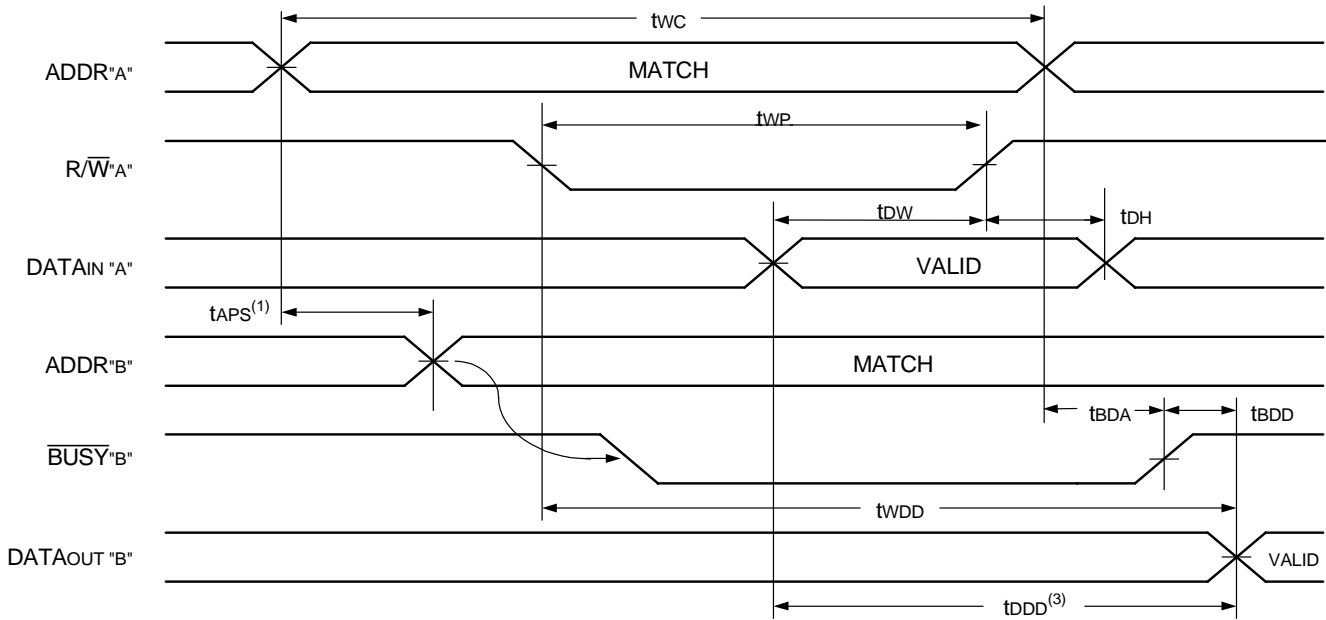

2739 drw 13

NOTES:

1. To ensure that the earlier of the two ports wins.  $t_{APS}$  is ignored for  $M/\bar{S} = V_{IL}$  (SLAVE).
2.  $\bar{CE}_L = \bar{CE}_R = V_{IL}$
3.  $\bar{OE} = V_{IL}$  for the reading port.
4. If  $M/\bar{S} = V_{IL}$  (slave) then  $\bar{BUSY}'A' = V_{IH}$  and  $\bar{BUSY}'B' = \text{"don't care"}$ , for this example.
5. All timing is the same for left and right port. Port "A" may be either left or right port. Port "B" is the port opposite from Port "A".

Timing Waveform of Write with **BUSY**

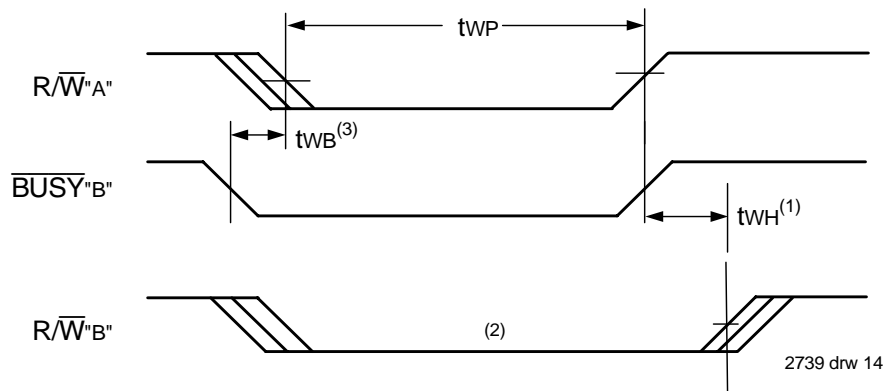

2739 drw 14

NOTES:

1.  $t_{WH}$  must be met for both  $\bar{BUSY}$  input (slave) and output (master).
2.  $\bar{BUSY}$  is asserted on Port "B", blocking  $R/\bar{W}'B'$ , until  $\bar{BUSY}'B'$  goes HIGH.
3.  $t_{WB}$  is only for the 'Slave' Version.

Waveform of **BUSY** Arbitration Controlled by **CE** Timing<sup>(1)</sup> ( $M/\bar{S} = V_{IH}$ )

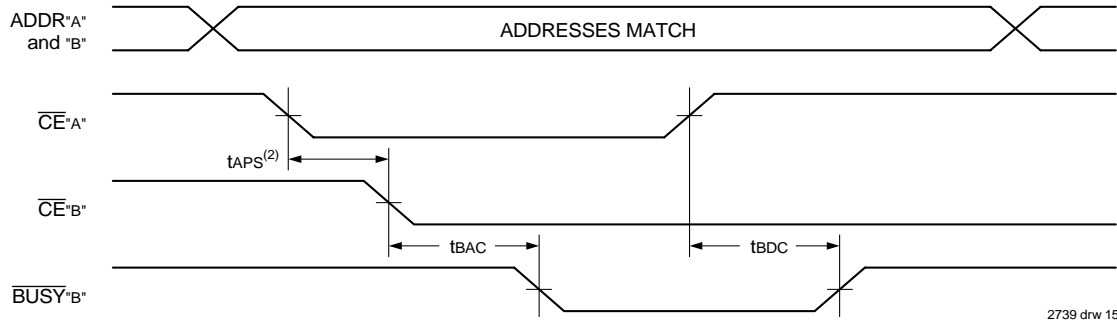

Waveform of **BUSY** Arbitration Cycle Controlled by Address Match Timing<sup>(1)</sup> ( $M/\bar{S} = V_{IH}$ )

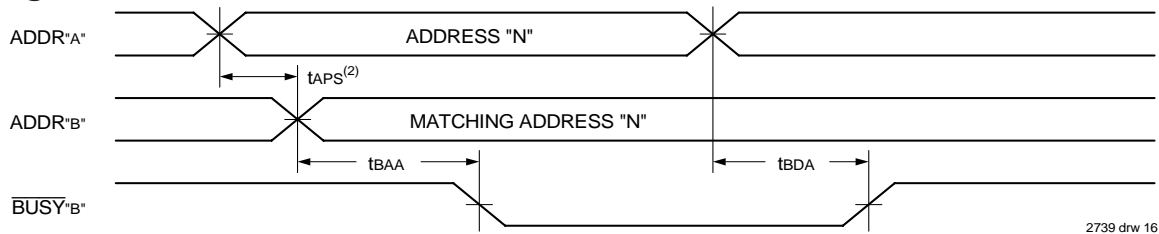

NOTES:

1. All timing is the same for left and right ports. Port "A" may be either the left or right port. Port "B" is the port opposite from port "A".
2. If tAPS is not satisfied, the **BUSY** signal will be asserted on one side or another but there is no guarantee on which side **BUSY** will be asserted.

AC Electrical Characteristics Over the Operating Temperature and Supply Voltage Range<sup>(1)</sup>

Symbol	Parameter	7006X15 Com'l Only		7006X17 Com'l Only		7006X20 Com'l, Ind & Military		7006X25 Com'l & Military		Unit
		Min.	Max.	Min.	Max.	Min.	Max.	Min.	Max.	
<b>INTERRUPT TIMING</b>										
tAS	Address Set-up Time	0	—	0	—	0	—	0	—	ns
tWR	Write Recovery Time	0	—	0	—	0	—	0	—	ns
tINS	Interrupt Set Time	—	15	—	15	—	20	—	20	ns
tINR	Interrupt Reset Time	—	15	—	15	—	20	—	20	ns

2739 tbl 16a

Symbol	Parameter	7006X35 Com'l & Military		7006X55 Com'l, Ind & Military		7006X70 Military Only		Unit
		Min.	Max.	Min.	Max.	Min.	Max.	
<b>INTERRUPT TIMING</b>								
tAS	Address Set-up Time	0	—	0	—	0	—	ns
tWR	Write Recovery Time	0	—	0	—	0	—	ns
tINS	Interrupt Set Time	—	25	—	40	—	50	ns
tINR	Interrupt Reset Time	—	25	—	40	—	50	ns

2739 tbl 16b

NOTES:

1. 'X' in part numbers indicates power rating (S or L).

## Waveform of Interrupt Timing<sup>(1)</sup>

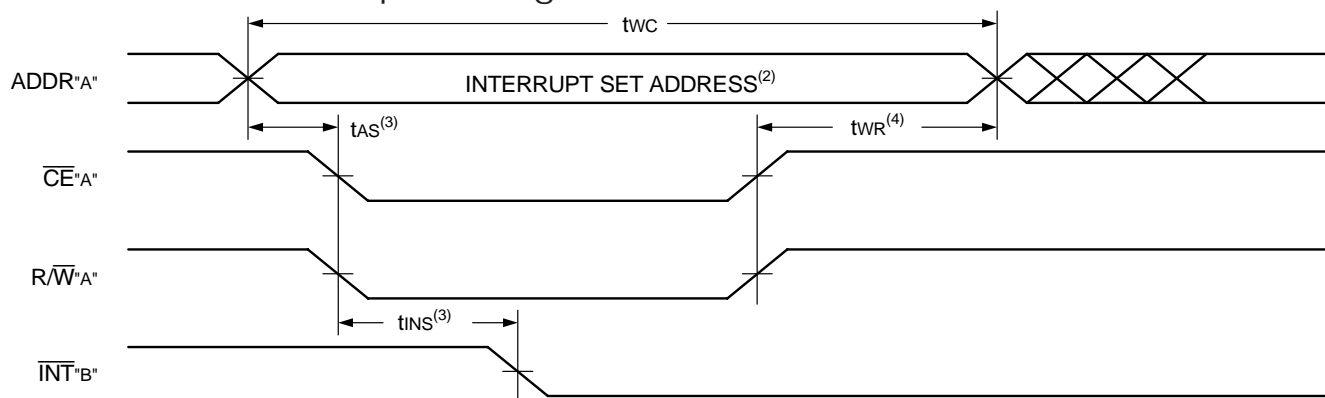

2739 drw 17

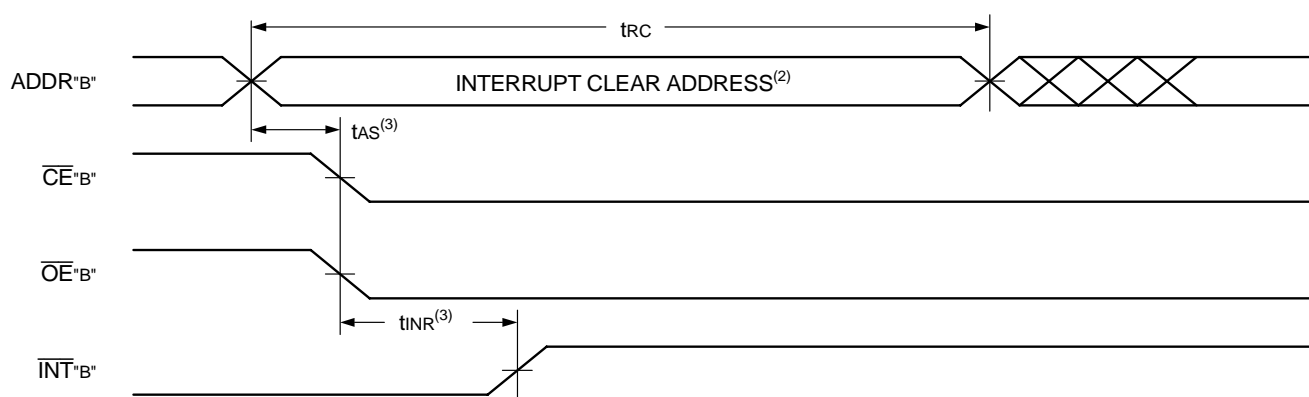

2739 drw 18

### NOTES:

1. All timing is the same for left and right ports. Port "A" may be either the left or right port. Port "B" is the port opposite from port "A".
2. See Interrupt Truth Table III.
3. Timing depends on which enable signal ( $\overline{CE}$  or  $R/\overline{W}$ ) is asserted last.
4. Timing depends on which enable signal ( $\overline{CE}$  or  $R/\overline{W}$ ) is de-asserted first.

## Truth Tables

Truth Table III — Interrupt Flag<sup>(1,4)</sup>

Left Port					Right Port					Function
$R/\overline{W}_L$	$\overline{CE}_L$	$\overline{OE}_L$	A13L-A0L	$\overline{INT}_L$	$R/\overline{W}_R$	$\overline{CE}_R$	$\overline{OE}_R$	A13R-A0R	$\overline{INT}_R$	
L	L	X	3FFF	X	X	X	X	X	L <sup>(2)</sup>	Set Right $\overline{INT}_R$ Flag
X	X	X	X	X	X	L	L	3FFF	H <sup>(3)</sup>	Reset Right $\overline{INT}_R$ Flag
X	X	X	X	L <sup>(3)</sup>	L	L	X	3FFE	X	Set Left $\overline{INT}_L$ Flag
X	L	L	3FFE	H <sup>(2)</sup>	X	X	X	X	X	Reset Left $\overline{INT}_L$ Flag

2739 tbl 17

### NOTES:

1. Assumes  $\overline{BUSY}_L = \overline{BUSY}_R = V_{IH}$ .
2. If  $\overline{BUSY}_L = V_{IL}$ , then no change.
3. If  $\overline{BUSY}_R = V_{IL}$ , then no change.
4.  $\overline{INTR}$  and  $\overline{INT}_L$  must be initialized at power-up.

Truth Table IV — Address **BUSY** Arbitration

Inputs			Outputs		Function
$\overline{CE}_L$	$\overline{CE}_R$	AOL-A13L AOR-A13R	$\overline{BUSY}_L^{(1)}$	$\overline{BUSY}_R^{(1)}$	
X	X	NO MATCH	H	H	Normal
H	X	MATCH	H	H	Normal
X	H	MATCH	H	H	Normal
L	L	MATCH	(2)	(2)	Write Inhibit <sup>(3)</sup>

2739 tbl 18

## NOTES:

1. Pins  $\overline{BUSY}_L$  and  $\overline{BUSY}_R$  are both outputs when the part is configured as a master. Both are inputs when configured as a slave.  $\overline{BUSY}_x$  outputs on the IDT7006 are push pull, not open drain outputs. On slaves the  $\overline{BUSY}_x$  input internally inhibits writes.
2. "L" if the inputs to the opposite port were stable prior to the address and enable inputs of this port. "H" if the inputs to the opposite port became stable after the address and enable inputs of this port. If  $t_{APS}$  is not met, either  $\overline{BUSY}_L$  or  $\overline{BUSY}_R = \text{LOW}$  will result.  $\overline{BUSY}_L$  and  $\overline{BUSY}_R$  outputs cannot be low simultaneously.
3. Writes to the left port are internally ignored when  $\overline{BUSY}_L$  outputs are driving low regardless of actual logic level on the pin. Writes to the right port are internally ignored when  $\overline{BUSY}_R$  outputs are driving LOW regardless of actual logic level on the pin.

Truth Table V — Example of Semaphore Procurement Sequence<sup>(1,2,3)</sup>

Functions	Do - D7 Left	Do - D7 Right	Status
No Action	1	1	Semaphore free
Left Port Writes "0" to Semaphore	0	1	Left port has semaphore token
Right Port Writes "0" to Semaphore	0	1	No change. Right side has no write access to semaphore
Left Port Writes "1" to Semaphore	1	0	Right port obtains semaphore token
Left Port Writes "0" to Semaphore	1	0	No change. Left port has no write access to semaphore
Right Port Writes "1" to Semaphore	0	1	Left port obtains semaphore token
Left Port Writes "1" to Semaphore	1	1	Semaphore free
Right Port Writes "0" to Semaphore	1	0	Right port has semaphore token
Right Port Writes "1" to Semaphore	1	1	Semaphore free
Left Port Writes "0" to Semaphore	0	1	Left port has semaphore token
Left Port Writes "1" to Semaphore	1	1	Semaphore free

2739 tbl 19

## NOTES:

1. This table denotes a sequence of events for only one of the eight semaphores on the IDT7006.
2. There are eight semaphore flags written to via I/O<sub>0</sub> and read from all I/O's. These eight semaphores are addressed by A<sub>0</sub> - A<sub>2</sub>.
3.  $\overline{CE} = V_{IH}$ ,  $\overline{SEM} = V_{IL}$  to access the semaphores. Refer to the Semaphore Read/Write Control Truth Table.

## Functional Description

The IDT7006 provides two ports with separate control, address and I/O pins that permit independent access for reads or writes to any location in memory. The IDT7006 has an automatic power down feature controlled by  $\overline{CE}$ . The  $\overline{CE}$  controls on-chip power down circuitry that permits the respective port to go into a standby mode when not selected ( $\overline{CE}$  HIGH). When a port is enabled, access to the entire memory array is permitted.

## Interrupts

If the user chooses the interrupt function, a memory location (mail box or message center) is assigned to each port. The left port interrupt flag ( $\overline{INT}_L$ ) is asserted when the right port writes to memory location 3FFE (HEX) where a write is defined as  $\overline{CE} = R/\overline{W} = V_{IL}$  per the Truth Table.

The left port clears the interrupt by reading address location 3FFE access when  $\overline{CE}_R = OER = V_{IL}$ ,  $R/\overline{W}$  is a "don't care". Likewise, the right port interrupt flag ( $\overline{INT}_R$ ) is asserted when the left port writes to memory location 3FFF (HEX) and to clear the interrupt flag ( $\overline{INT}_R$ ), the right port must read the memory location 3FFF. The message (8 bits) at 3FFE or 3FFF is user-defined, since it is an addressable SRAM location. If the interrupt function is not used, address locations 3FFE and 3FFF are not used as mail boxes, but as part of the random access memory. Refer to Truth Table III for the interrupt operation.

## Busy Logic

Busy Logic provides a hardware indication that both ports of the RAM

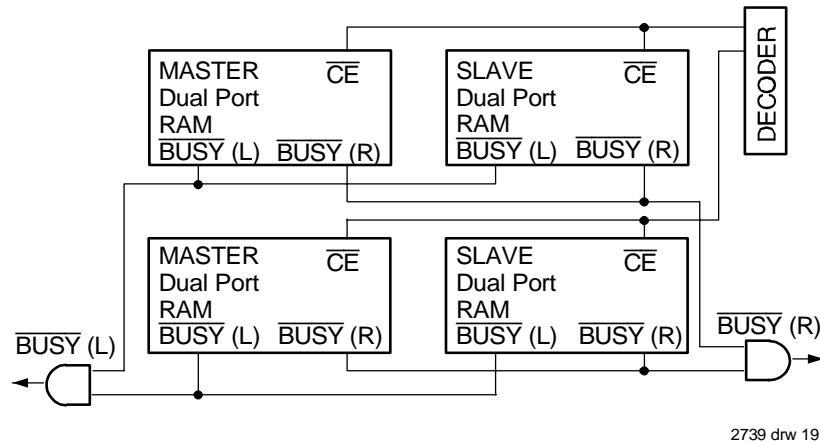

Figure 3. Busy and chip enable routing for both width and depth expansion with IDT7006 RAMs.

have accessed the same location at the same time. It also allows one of the two accesses to proceed and signals the other side that the RAM is “busy”. The  $\overline{\text{BUSY}}$  pin can then be used to stall the access until the operation on the other side is completed. If a write operation has been attempted from the side that receives a  $\overline{\text{BUSY}}$  indication, the write signal is gated internally to prevent the write from proceeding.

The use of  $\overline{\text{BUSY}}$  logic is not required or desirable for all applications. In some cases it may be useful to logically OR the  $\overline{\text{BUSY}}$  outputs together and use any  $\overline{\text{BUSY}}$  indication as an interrupt source to flag the event of an illegal or illogical operation. If the write inhibit function of  $\overline{\text{BUSY}}$  logic is not desirable, the  $\overline{\text{BUSY}}$  logic can be disabled by placing the part in slave mode with the  $\overline{\text{M/S}}$  pin. Once in slave mode the  $\overline{\text{BUSY}}$  pin operates solely as a write inhibit input pin. Normal operation can be programmed by tying the  $\overline{\text{BUSY}}$  pins HIGH. If desired, unintended write operations can be prevented to a port by tying the  $\overline{\text{BUSY}}$  pin for that port LOW.

The  $\overline{\text{BUSY}}$  outputs on the IDT 7006 RAM in master mode, are push-pull type outputs and do not require pull up resistors to operate. If these RAMs are being expanded in depth, then the  $\overline{\text{BUSY}}$  indication for the resulting array requires the use of an external AND gate.

## Width Expansion with Busy Logic Master/Slave Arrays

When expanding an IDT7006 RAM array in width while using  $\overline{\text{BUSY}}$  logic, one master part is used to decide which side of the RAMs array will receive a  $\overline{\text{BUSY}}$  indication, and to output that indication. Any number of slaves to be addressed in the same address range as the master, use the  $\overline{\text{BUSY}}$  signal as a write inhibit signal. Thus on the IDT7006 RAM the  $\overline{\text{BUSY}}$  pin is an output if the part is used as a master ( $\overline{\text{M/S}}$  pin =  $V_{IH}$ ), and the  $\overline{\text{BUSY}}$  pin is an input if the part used as a slave ( $\overline{\text{M/S}}$  pin =  $V_{IL}$ ) as shown in Figure 3.

If two or more master parts were used when expanding in width, a split decision could result with one master indicating  $\overline{\text{BUSY}}$  on one side of the array and another master indicating  $\overline{\text{BUSY}}$  on one other side of the array. This would inhibit the write operations from one port for part of a word and inhibit the write operations from the other port for the other part of the word.

The  $\overline{\text{BUSY}}$  arbitration, on a master, is based on the chip enable and address signals only. It ignores whether an access is a read or write. In

a master/slave array, both address and chip enable must be valid long enough for a  $\overline{\text{BUSY}}$  flag to be output from the master before the actual write pulse can be initiated with the  $\overline{\text{RW}}$  signal. Failure to observe this timing can result in a glitched internal write inhibit signal and corrupted data in the slave.

## SEMAPHORES

The IDT7006 is an extremely fast Dual-Port 16K x 8 CMOS Static RAM with an additional 8 address locations dedicated to binary semaphore flags. These flags allow either processor on the left or right side of the Dual-Port RAM to claim a privilege over the other processor for functions defined by the system designer’s software. As an example, the semaphore can be used by one processor to inhibit the other from accessing a portion of the Dual-Port RAM or any other shared resource.

The Dual-Port RAM features a fast access time, and both ports are completely independent of each other. This means that the activity on the left port in no way slows the access time of the right port. Both ports are identical in function to standard CMOS Static RAM and can be read from, or written to, at the same time with the only possible conflict arising from the simultaneous writing of, or a simultaneous READ/WRITE of, a non-semaphore location. Semaphores are protected against such ambiguous situations and may be used by the system program to avoid any conflicts in the non-semaphore portion of the Dual-Port RAM. These devices have an automatic power-down feature controlled by  $\overline{\text{CE}}$ , the Dual-Port RAM enable, and  $\overline{\text{SEM}}$ , the semaphore enable. The  $\overline{\text{CE}}$  and  $\overline{\text{SEM}}$  pins control on-chip power down circuitry that permits the respective port to go into standby mode when not selected. This is the condition which is shown in Truth Table I where  $\overline{\text{CE}}$  and  $\overline{\text{SEM}}$  are both HIGH.

Systems which can best use the IDT7006 contain multiple processors or controllers and are typically very high-speed systems which are software controlled or software intensive. These systems can benefit from a performance increase offered by the IDT7006s hardware semaphores, which provide a lockout mechanism without requiring complex programming.

Software handshaking between processors offers the maximum in system flexibility by permitting shared resources to be allocated in varying configurations. The IDT7006 does not use its semaphore flags to control

any resources through hardware, thus allowing the system designer total flexibility in system architecture.

An advantage of using semaphores rather than the more common methods of hardware arbitration is that wait states are never incurred in either processor. This can prove to be a major advantage in very high-speed systems.

## How the Semaphore Flags Work

The semaphore logic is a set of eight latches which are independent of the Dual-Port RAM. These latches can be used to pass a flag, or token, from one port to the other to indicate that a shared resource is in use. The semaphores provide a hardware assist for a use assignment method called "Token Passing Allocation." In this method, the state of a semaphore latch is used as a token indicating that shared resource is in use. If the left processor wants to use this resource, it requests the token by setting the latch. This processor then verifies its success in setting the latch by reading it. If it was successful, it proceeds to assume control over the shared resource. If it was not successful in setting the latch, it determines that the right side processor has set the latch first, has the token and is using the shared resource. The left processor can then either repeatedly request that semaphore's status or remove its request for that semaphore to perform another task and occasionally attempt again to gain control of the token via the set and test sequence. Once the right side has relinquished the token, the left side should succeed in gaining control.

The semaphore flags are active LOW. A token is requested by writing a zero into a semaphore latch and is released when the same side writes a one to that latch.

The eight semaphore flags reside within the IDT7006 in a separate memory space from the Dual-Port RAM. This address space is accessed by placing a LOW input on the  $\overline{SEM}$  pin (which acts as a chip select for the semaphore flags) and using the other control pins (Address,  $\overline{OE}$ , and  $R/\overline{W}$ ) as they would be used in accessing a standard Static RAM. Each of the flags has a unique address which can be accessed by either side through address pins A0 – A2. When accessing the semaphores, none of the other address pins has any effect.

When writing to a semaphore, only data pin D0 is used. If a LOW level is written into an unused semaphore location, that flag will be set to a zero on that side and a one on the other side (see Truth Table V). That semaphore can now only be modified by the side showing the zero. When a one is written into the same location from the same side, the flag will be set to a one for both sides (unless a semaphore request from the other side is pending) and then can be written to by both sides. The fact that the side which is able to write a zero into a semaphore subsequently locks out writes from the other side is what makes semaphore flags useful in interprocessor communications. (A thorough discussion on the use of this feature follows shortly.) A zero written into the same location from the other side will be stored in the semaphore request latch for that side until the semaphore is freed by the first side.

When a semaphore flag is read, its value is spread into all data bits so that a flag that is a one reads as a one in all data bits and a flag containing a zero reads as all zeros. The read value is latched into one side's output register when that side's semaphore select ( $\overline{SEM}$ ) and output enable ( $\overline{OE}$ ) signals go active. This serves to disallow the semaphore from changing state in the middle of a read cycle due to a write cycle from the other side. Because of this latch, a repeated read of a semaphore in a test loop must

cause either signal ( $\overline{SEM}$  or  $\overline{OE}$ ) to go inactive or the output will never change.

A sequence WRITE/READ must be used by the semaphore in order to guarantee that no system level contention will occur. A processor requests access to shared resources by attempting to write a zero into a semaphore location. If the semaphore is already in use, the semaphore request latch will contain a zero, yet the semaphore flag will appear as one, a fact which the processor will verify by the subsequent read (see Truth Table V). As an example, assume a processor writes a zero to the left port at a free semaphore location. On a subsequent read, the processor will verify that it has written successfully to that location and will assume control over the resource in question. Meanwhile, if a processor on the right side attempts to write a zero to the same semaphore flag it will fail, as will be verified by the fact that a one will be read from that semaphore on the right side during subsequent read. Had a sequence of READ/WRITE been used instead, system contention problems could have occurred during the gap between the read and write cycles.

It is important to note that a failed semaphore request must be followed by either repeated reads or by writing a one into the same location. The reason for this is easily understood by looking at the simple logic diagram of the semaphore flag in Figure 4. Two semaphore request latches feed into a semaphore flag. Whichever latch is first to present a zero to the semaphore flag will force its side of the semaphore flag LOW and the other side HIGH. This condition will continue until a one is written to the same semaphore request latch. Should the other side's semaphore request latch have been written to a zero in the meantime, the semaphore flag will flip over to the other side as soon as a one is written into the first side's request latch. The second side's flag will now stay LOW until its semaphore request latch is written to a one. From this it is easy to understand that, if a semaphore is requested and the processor which requested it no longer needs the resource, the entire system can hang up until a one is written into that semaphore request latch.

The critical case of semaphore timing is when both sides request a single token by attempting to write a zero into it at the same time. The semaphore logic is specially designed to resolve this problem. If simultaneous requests are made, the logic guarantees that only one side receives the token. If one side is earlier than the other in making the request, the first side to make the request will receive the token. If both requests arrive at the same time, the assignment will be arbitrarily made to one port or the other.

One caution that should be noted when using semaphores is that semaphores alone do not guarantee that access to a resource is secure. As with any powerful programming technique, if semaphores are misused or misinterpreted, a software error can easily happen.

Initialization of the semaphores is not automatic and must be handled via the initialization program at power-up. Since any semaphore request flag which contains a zero must be reset to a one, all semaphores on both sides should have a one written into them at initialization from both sides to assure that they will be free when needed.

## Using Semaphores—Some Examples

Perhaps the simplest application of semaphores is their application as resource markers for the IDT7006's Dual-Port RAM. Say the 16K x 8 RAM was to be divided into two 8K x 8 blocks which were to be dedicated at any one time to servicing either the left or right port. Semaphore 0 could be used

to indicate the side which would control the lower section of memory, and Semaphore 1 could be defined as the indicator for the upper section of memory.

To take a resource, in this example the lower 8K of Dual-Port RAM, the processor on the left port could write and then read a zero into Semaphore 0. If this task were successfully completed (a zero was read back rather than a one), the left processor would assume control of the lower 8K. Meanwhile the right processor was attempting to gain control of the resource after the left processor, it would read back a one in response to the zero it had attempted to write into Semaphore 0. At this point, the software could choose to try and gain control of the second 8K section by writing, then reading a zero into Semaphore 1. If it succeeded in gaining control, it would lock out the left side.

Once the left side was finished with its task, it would write a one to Semaphore 0 and may then try to gain access to Semaphore 1. If Semaphore 1 was still occupied by the right side, the left side could undo its semaphore request and perform other tasks until it was able to write, then read a zero into Semaphore 1. If the right processor performs a similar task with Semaphore 0, this protocol would allow the two processors to swap 8K blocks of Dual-Port RAM with each other.

The blocks do not have to be any particular size and can even be variable, depending upon the complexity of the software using the semaphore flags. All eight semaphores could be used to divide the Dual-Port RAM or other shared resources into eight parts. Semaphores can

even be assigned different meanings on different sides rather than being given a common meaning as was shown in the example above.

Semaphores are a useful form of arbitration in systems like disk interfaces where the CPU must be locked out of a section of memory during a transfer and the I/O device cannot tolerate any wait states. With the use of semaphores, once the two devices has determined which memory area was "off-limits" to the CPU, both the CPU and the I/O devices could access their assigned portions of memory continuously without any wait states.

Semaphores are also useful in applications where no memory "WAIT" state is available on one or both sides. Once a semaphore handshake has been performed, both processors can access their assigned RAM segments at full speed.

Another application is in the area of complex data structures. In this case, block arbitration is very important. For this application one processor may be responsible for building and updating a data structure. The other processor then reads and interprets that data structure. If the interpreting processor reads an incomplete data structure, a major error condition may exist. Therefore, some sort of arbitration must be used between the two different processors. The building processor arbitrates for the block, locks it and then is able to go in and update the data structure. When the update is completed, the data structure block is released. This allows the interpreting processor to come back and read the complete data structure, thereby guaranteeing a consistent data structure.

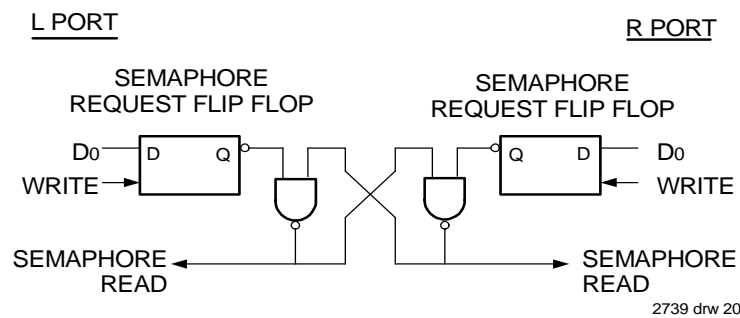
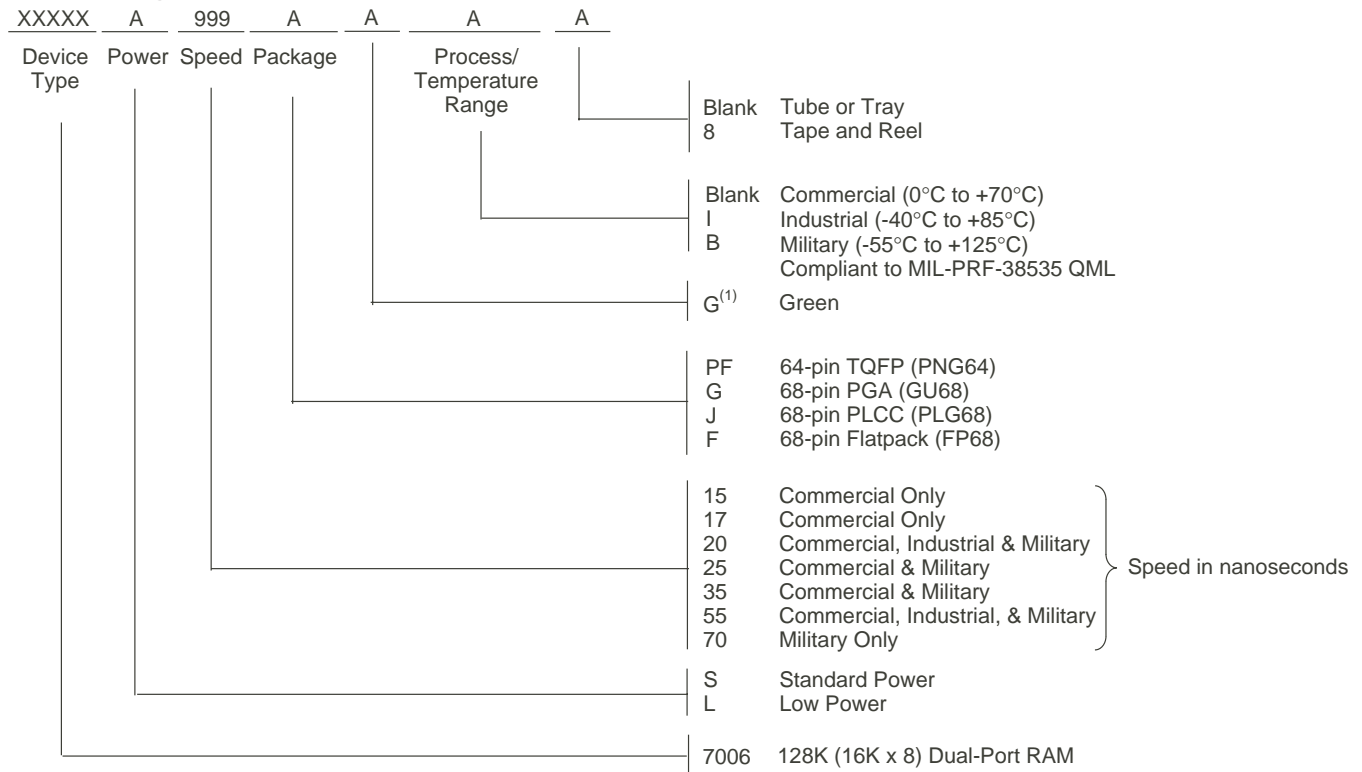

Figure 4. IDT7006 Semaphore Logic

### Ordering Information



**NOTES:**

- 1. Green parts available. For specific speeds, packages and powers contact your local sales office.  
**LEAD FINISH (SnPb) parts are in EOL process. Product Discontinuation Notice - PDN# SP-17-02**

2739 drw 21

### Datasheet Document History

01/04/99:		Initiated datasheet document history Converted to new format Cosmetic and typographical corrections Added additional notes to pin configurations
06/03/99:		Changed drawing format
09/14/99:	Page 15	Changed 3FFF to 3FFE in Truth Table III
11/10/99:		Replaced IDT logo
12/22/99:	Page 1	Corrected drawing error
05/08/00:	Page 1	Added copyright info
	Page 4	Increased storage temperature parameter Clarified TA parameter
	Page 6	DC Electrical parameters—changed wording from "open" to "disabled" Changed ±500mV to 0mV in notes
09/12/01:	Page 2 & 3	Added date revision for pin configurations
	Page 6	Added Industrial temp to the column heading for 20ns to DC Electrical Characteristics
	Pages 7,9,12&14	Added Industrial temp to the column headings for 20ns to AC Electrical Characteristics
	Page 7	Table 13a appeared twice, corrected and placed table 13b for 35, 55 & 70ns speeds
	Pages 4,6,7,9, 12 & 14	Removed Industrial temp note from all tables
	Page 20	Added Industrial temp to 20ns in ordering information

## Datasheet Document History (cont'd)

01/31/06:	Page 1	Added green availability to features
	Page 20	Added green indicator to ordering information
10/21/08:	Page 20	Removed "IDT" from orderable part number
08/07/14:	Page 20	Added Tape and Reel to Ordering Information
	Page 2, 3 & 20	The package codes changed from PN64-1, G68-1, J68-1 & F68-1 to PN64, G68, J68 & F68 respectively to match the standard package codes
07/10/18:		Updated Ordering information package names to (PNG64), (GU68), (PLG68), (FP68) Product Discontinuation Notice - PDN# SP-17-02 Last time buy expires June 15, 2018

**CORPORATE HEADQUARTERS**

6024 Silver Creek Valley Road  
San Jose, CA 95138

**for SALES:**

800-345-7015 or 408-284-8200  
fax: 408-284-2775  
www.idt.com

**for Tech Support:**

408-284-2794  
DualPortHelp@idt.com

The IDT logo is a registered trademark of Integrated Device Technology, Inc.

## Looking for pricing, stock, or lifecycle information?

Click below to explore more details on WIN SOURCE:

- ⊖ [View 7006L20PF18 on WIN SOURCE](#)
- ⊖ [IDT, Integrated Device Technology Inc Information](#)

## Optimize Your Supply Chain with WIN SOURCE Solutions

- ✓ Global Sourcing Solution
- ✓ Obsolete Management
- ✓ Cost Control Management
- ✓ Shortage Management
- ✓ Alternative Solution
- ✓ Excess Inventory Management