

Enhanced Differential Mode Performance K Series RFI Line Filters

DK Series

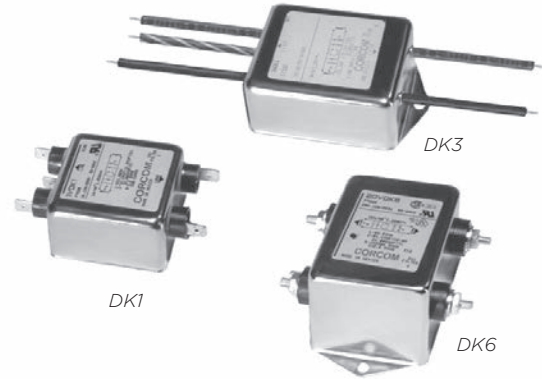

UL Recognized
CSA Certified
VDE Approved



DK Series

- Higher performance Line to Line attenuation than the K Series
- E version meets the low leakage current requirements of VDE portable equipment and non-patient care equipment
- V version features same high performance with more cost-effective design

Ordering Information

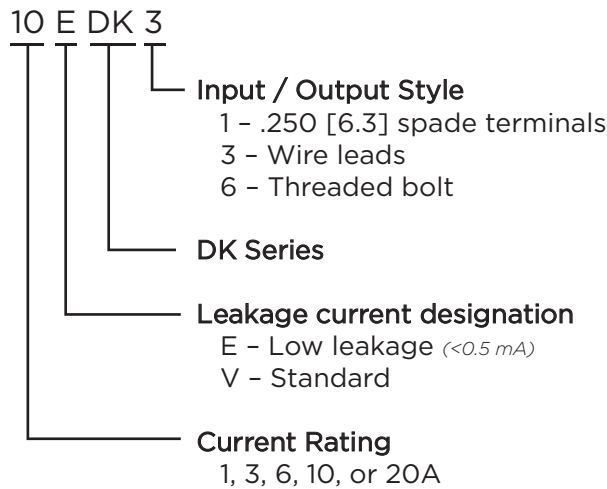

Electrical Schematic

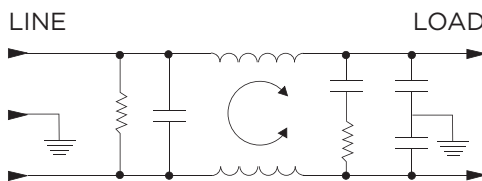

Specifications

Maximum leakage current each Line to Ground:

	VDK Models	EDK Models
@ 120 VAC 60 Hz:	.4 mA	.22 mA
@ 250 VAC 50 Hz:	.7 mA	.38 mA

Hipot rating (one minute):

Line to Ground:	2250 VDC
Line to Line:	1450 VDC

Rated Voltage (max):

250 VAC

Operating Frequency:

50/60 Hz

Rated Current:

1 to 20A

Operating Ambient Temperature Range

(at rated current I_r): -10°C to $+40^{\circ}\text{C}$
In an ambient temperature (T_a) higher than $+40^{\circ}\text{C}$ the maximum operating current (I_o) is calculated as follows: $I_o = I_r \sqrt{(85-T_a)/45}$

Available Part Numbers

1VVK1	1EDK1
1VVK3	1EDK3
3VVK1	3EDK1
3VVK3	3EDK3
6VVK1	6EDK1
6VVK3	6EDK3
10VVK1	10EDK1
10VVK3	10EDK3
20VVK1	20EDK1
20VVK6	

Enhanced Differential Mode K Series RFI Power Line Filters *(continued)*

DK Series

Case Styles

VDK1 / EDK1

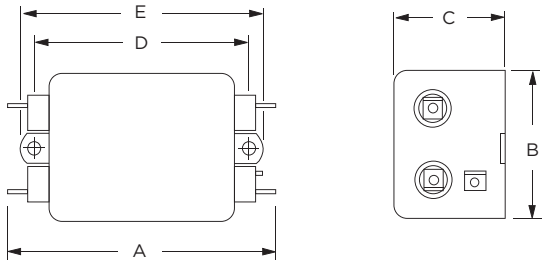

Typical Dimensions:
 Line/Load Terminals (4): .250 [6.3] with .07 [1.8] Dia. hole
 Ground Terminal (1): .250 [6.3] with .07 x .16 [1.8 x 3.8] slot
 Mounting Holes (2): .188 [4.75] Dia.

VDK3 / EDK3

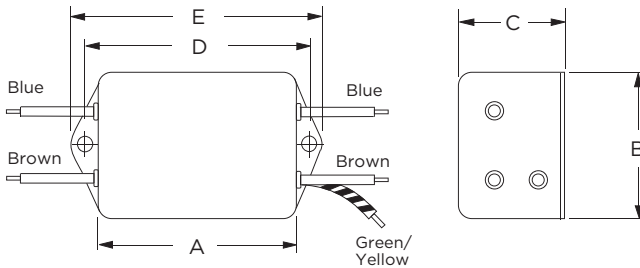

Typical Dimensions:
 Wire leads (5): 4.0 [101.6] Min., AWG18 (AWG16 for 10A)
 Mounting Holes (2): .188 [4.75] Dia.

20VVDK1 / 20VEDK1

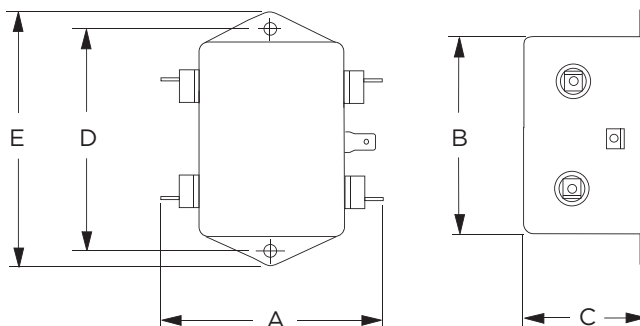

Typical Dimensions:
 Line/Load Terminals (4): .250 [6.3] with .07 [1.8] Dia. hole
 Ground Terminal (1): .250 [6.3] with .07 x .16 [1.8 x 3.8] slot
 Mounting Holes (4): .188 [4.75] Dia.

20VVDK6

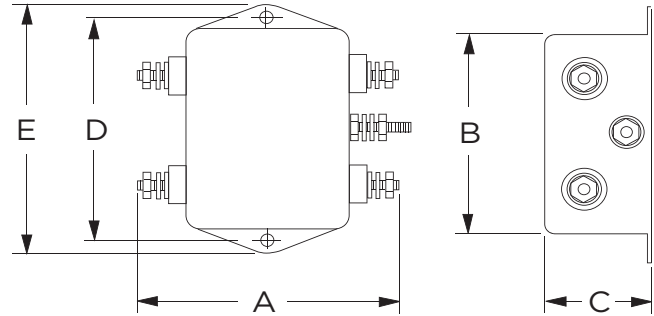

Typical Dimensions:
 Terminals (5): 8-32, Torque 18 lbf-in. [2.03 N-m] max. ± 2 [22]
 Mounting Holes (2): .188 [4.75] Dia.

Case Dimensions

Part No.	A (max)	B (max)	C (max)	D $\pm .015$ $\pm .38$	E (max)
1VVDK1, 1VEDK1	3.35 85.1	2.07 52.6	1.16 29.5	2.375 60.33	2.81 71.4
1VVDK3, 1VEDK3	2.07 52.6	2.07 52.6	1.16 29.5	2.375 60.33	2.81 71.4
3VVDK1, 3VEDK1, 6VVDK1, 6VEDK1	3.85 97.8	2.07 52.6	1.16 29.5	2.938 74.63	3.35 85.1
3VVDK3, 3VEDK3, 6VVDK3, 6VEDK3	2.56 65.0	2.07 52.6	1.16 29.5	2.938 74.63	3.35 85.1
10VVDK1, 10VEDK1	3.85 97.8	2.07 52.6	1.32 33.5	2.938 74.63	3.35 85.1
10VVDK3, 10VEDK3	2.57 65.3	2.07 52.6	1.32 33.5	2.938 74.63	3.35 85.1
20VVDK1, 20VEDK1	3.85 97.8	2.58 65.5	1.78 45.2	2.938 74.63	3.35 85.1
20VVDK6	3.46 87.9	2.58 65.5	1.78 45.2	2.938 74.63	3.35 85.1

Enhanced Differential Mode K Series RFI Power Line Filters *(continued)*

DK Series

Performance Data

Typical Insertion Loss

Measured in closed 50 Ohm system

1 & 3VDK

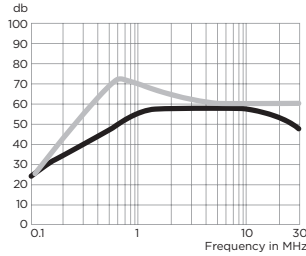

6, 10, 20VDK

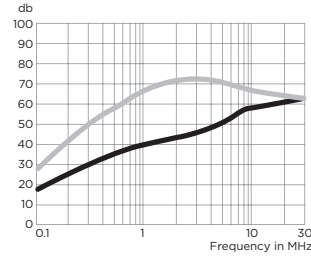

1 & 3EDK

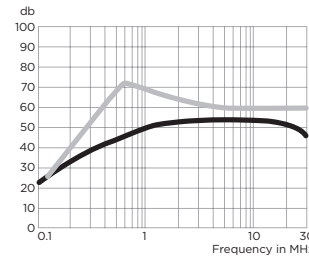

6, 10, 20EDK

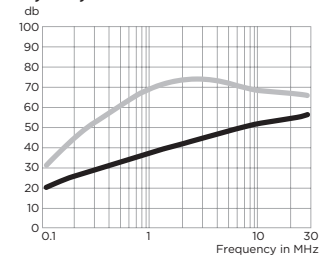

— Common Mode / Asymmetrical (L-G)
— Differential Mode / Symmetrical (L-L)

Minimum Insertion Loss

Measured in closed 50 Ohm system

Common Mode / Asymmetrical (Line to Ground)

Current Rating	Frequency – MHz					
	.15	.5	1	5	10	30
VDK Models						
1A, 3A	18	30	40	48	48	40
6A, 10A, 20A	10	22	30	39	44	50
EDK Models						
1A, 3A	17	27	33	45	45	40
6A, 10A, 20A	10	19	25	34	40	46

Differential Mode / Symmetrical (Line to Line)

Current Rating	Frequency – MHz					
	.15	.5	1	5	10	30
VDK & EDK Models						
1A, 3A	18	47	62	60	50	45
6A, 10A, 20A	20	43	55	65	60	55

Looking for pricing, stock, or lifecycle information?

Click below to explore more details on WIN SOURCE:

 [View 10EDK1](#) on WIN SOURCE

 [TE Connectivity](#) Information

Optimize Your Supply Chain with WIN SOURCE Solutions

-  Global Sourcing Solution
-  Obsolete Management
-  Cost Control Management
-  Shortage Management
-  Alternative Solution
-  Excess Inventory Management