

Model 416

Miniature Surface Mount Crystal

Features

- Hermetic Ceramic Surface Mount Package
- Fundamental Crystal Design
- Frequency Range 24 – 80MHz
- Frequency Tolerance, ± 20 ppm Standard
- Frequency Stability, ± 20 ppm Standard
- Operating Temperature Range to -40°C to $+85^{\circ}\text{C}$
- Tape and Reel Packaging, EIA-418

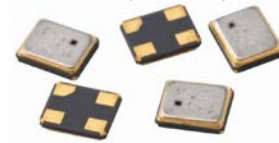

Part Dimensions:
1.6 x 1.2 x 0.45mm • 2.51054mg

Applications

- Wearable and Handheld Electronics
- Wireless Communications
- FPGA/Microcontrollers
- Computer Peripherals
- USB Interfaces
- Measuring Equipment
- Consumer Electronics
- High Density Board Layouts

Description

CTS Model 416 incorporates a high Q quartz resonator and is ideal for supporting a wide range of commercial and industrial applications.

Ordering Information

Model	Mode of Oscillation	Frequency Code [MHz]	Tolerance @ +25°C	Temperature Stability	Temperature Range	Load Capacitance	Packaging
416	F	XXX	3	5	C	D	R
	Code Mode		Code Tolerance		Code Temp. Range		Code Packing
	F Fundamental		1 ± 10 ppm X ± 15 ppm 2 ± 20 ppm Y ± 25 ppm 3 ± 30 ppm		A -10°C to $+60^{\circ}\text{C}$ C -20°C to $+70^{\circ}\text{C}$ D -30°C to $+85^{\circ}\text{C}$ I -40°C to $+85^{\circ}\text{C}$		R 3k pcs./reel
		Code Frequency		Code Stability		Code Capacitance Code Capacitance	
		Product Frequency Code ¹		1 ± 10 ppm ² X ± 15 ppm 2 ± 20 ppm Y ± 25 ppm 3 ± 30 ppm 5 ± 50 ppm		W 5pF L 12pF T 6pF C 16pF V 7pF D 18pF K 8pF E 20pF J 9pF S Series A 10pF	

Notes:

- 1] Refer to document 016-1454-0, Frequency Code Tables. 3-digits for frequencies <100MHz.
- 2] Check factory availability when combined with -40°C to $+85^{\circ}\text{C}$ temperature range.

**Not all performance combinations and frequencies may be available.
Contact your local CTS Representative or CTS Customer Service for availability.**

This product is specified for use only in standard commercial applications. Supplier disclaims all express and implied warranties and liability in connection with any use of this product in any non-commercial applications or in any application that may expose the product to conditions that are outside of the tolerances provided in its specification.



Electrical Specifications

Operating Conditions

PARAMETER	SYMBOL	CONDITIONS	MIN	TYP	MAX	UNIT
Operating Temperature	T _A	-	-10		+60	°C
			-20	+25	+70	
			-30		+85	
			-40		+85	
Storage Temperature	T _{STG}	-	-40	-	+90	°C

Frequency Stability

PARAMETER	SYMBOL	CONDITIONS	MIN	TYP	MAX	UNIT
Frequency Range	f ₀	-		24 - 80		MHz
Frequency Tolerance	Δf/f ₀	@ +25°C		10, 15, 20, 25 or 30		±ppm
Frequency Stability	Δf/f ₂₅	Referenced to +25°C reading		10, 15, 20, 25, 30 or 50		±ppm
Aging	Δf/f ₀	Typical per year @ +25°C	-	±3	-	ppm

Crystal Parameters

PARAMETER	SYMBOL	CONDITIONS	MIN	TYP	MAX	UNIT
Operating Mode	-	-		Fundamental		-
Crystal Cut	-	-		AT-Cut Strip		-
Load Capacitance	C _L	-		See Ordering Information		pF
Shunt Capacitance	C ₀	-	-	3.0	5.0	pF
Series Resistance						
Fundamental	R ₁	24MHz - <30MHz	-	-	120	Ω
		30MHz - <37MHz	-	-	80	
		37MHz - <80MHz	-	-	60	
Drive Level	DL	-	-	10	200	μW
Insulation Resistance	R _i	+100Vdc ±15Vdc	500	-	-	MΩ

Δf/f₀ - Frequency deviation referenced to nominal frequency.

Δf/f₂₅ - Frequency deviation referenced to +25°C frequency.

Mechanical Specifications

Package Drawing

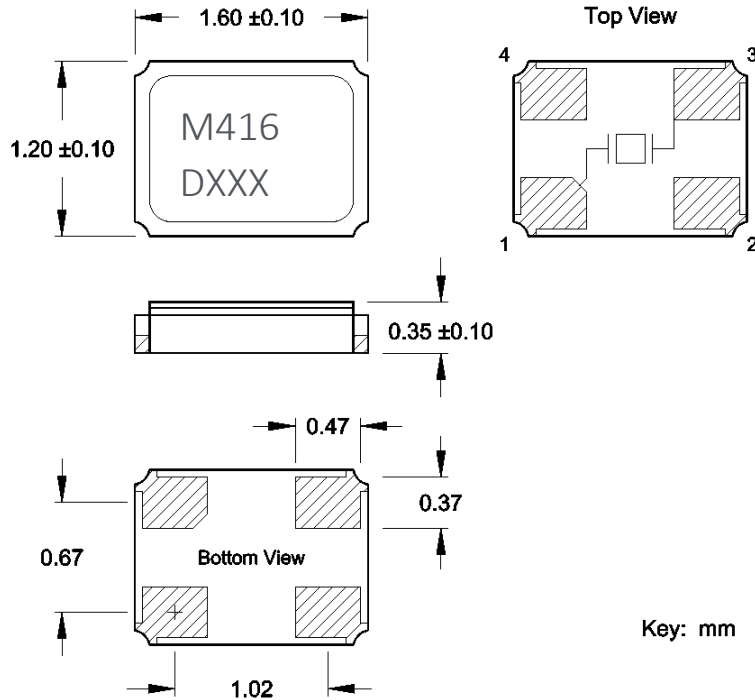

Key: mm

Marking Information

Format A – 2 Lines [Preferred]

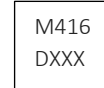

1. M416 – CTS Model series.
2. D – Date code. See Table I for codes.
3. XXX – Frequency code, 3-digits frequencies below 100MHz.
[See document 016-1454-0, Frequency Code Tables].

Format B – 1 Line [Acceptable]

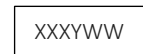

1. XXX – XXX – Frequency code, 3-digits frequencies below 100MHz.
[See document 016-1454-0, Frequency Code Tables].
2. YWW – Date code; Y = year [last digit], WW = week.

Recommended Pad Layout

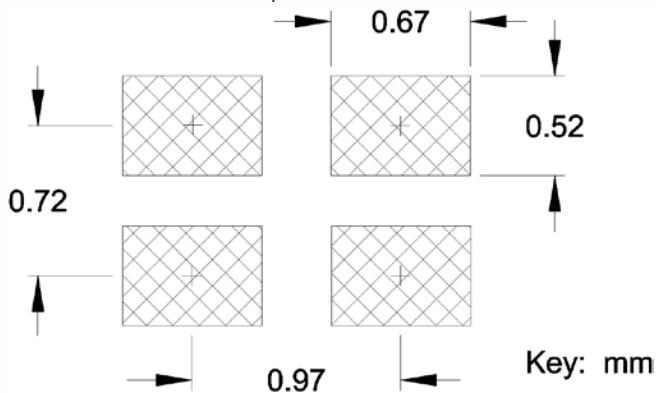

Key: mm

Notes

1. Terminations #2, #4 and metal lid are connected internally. End user may connect these pins to circuit ground for EMI suppression.
2. JEDEC termination code (e4). Barrier-plating is nickel [Ni] with gold [Au] flash plate.
2. Reflow conditions per JEDEC J-STD-020; +260°C maximum, 20 seconds.
3. MSL = 1.

Table I - Date Code

YEAR		MONTH														
		JAN	FEB	MAR	APR	MAY	JUN	JUL	AUG	SEP	OCT	NOV	DEC			
2001	2005	2009	2013	2017	A	B	C	D	E	F	G	H	J	K	L	M
2002	2006	2010	2014	2018	N	P	Q	R	S	T	U	V	W	X	Y	Z
2003	2007	2011	2015	2019	a	b	c	d	e	f	g	h	j	k	l	m
2004	2008	2012	2016	2020	n	p	q	r	s	t	u	v	w	x	y	z

Packaging - Tape and Reel

Tape Drawing

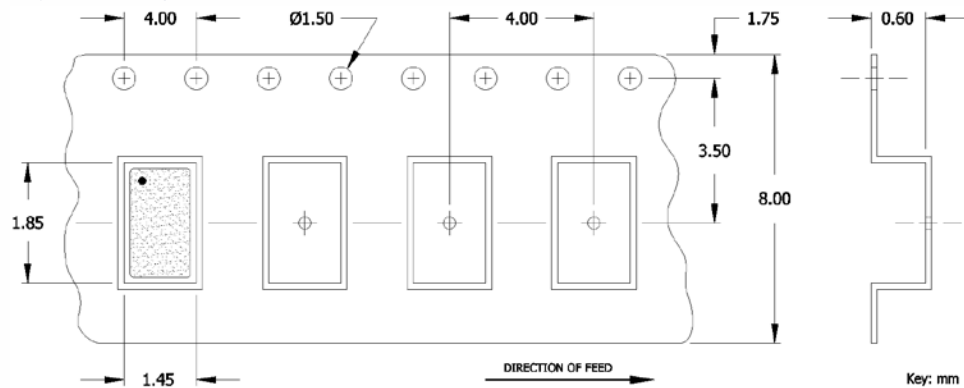

Reel Drawing

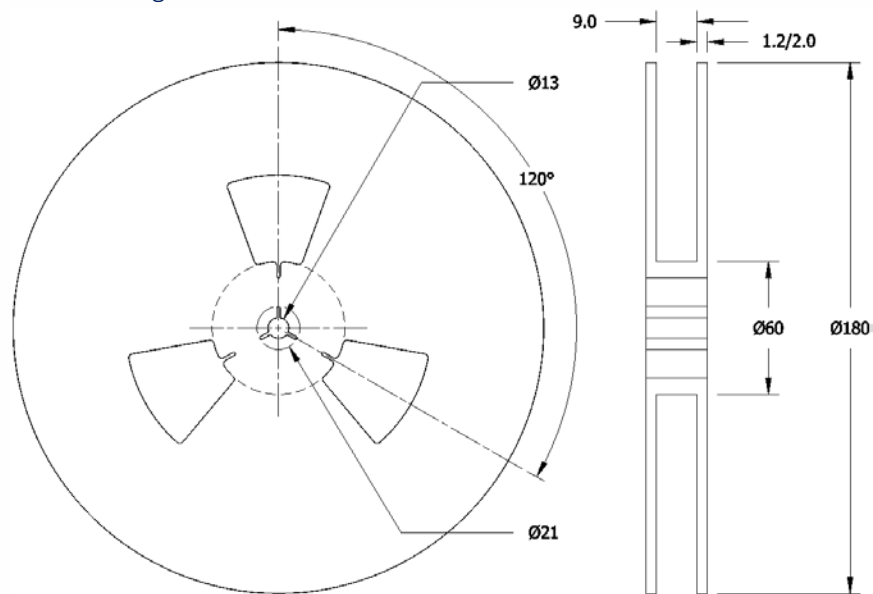

Notes

1. Device quantity is 3k pieces maximum per 180mm reel.
2. Complete CTS part number, frequency value, date code and manufacturing site code information must appear on reel and carton labels.

Looking for pricing, stock, or lifecycle information?

Click below to explore more details on WIN SOURCE:

-  [View 416F26035ALR on WIN SOURCE](#)
-  [CTS-Frequency Controls Information](#)

Optimize Your Supply Chain with WIN SOURCE Solutions

-  Global Sourcing Solution
-  Obsolete Management
-  Cost Control Management
-  Shortage Management
-  Alternative Solution
-  Excess Inventory Management