

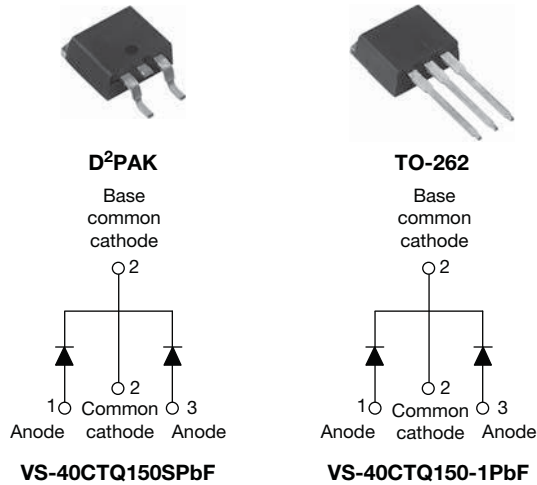

**THE DATASHEET OF
VS-40CTQ150-1PBF**



Schottky Rectifier, 2 x 20 A



FEATURES

- AEC-Q101 qualified
- Very low forward voltage drop
- Halogen-free according to IEC 61249-2-21 definition
- 175 °C T_J operation
- Center tap TO-220 package
- High frequency operation
- High purity, high temperature epoxy encapsulation for enhanced mechanical strength and moisture resistance
- Guard ring for enhanced ruggedness and long term reliability
- Meets MSL level 1, per J-STD-020, LF maximum peak of 260 °C
- Compliant to RoHS Directive 2002/95/EC



RoHS
COMPLIANT
HALOGEN
FREE

PRODUCT SUMMARY

Package	TO-262AA, TO-263AB (D ² PAK)
I _{F(AV)}	2 x 20 A
V _R	150 V
V _F at I _F	0.71 V
I _{RM}	15 mA at 125 °C
T _J max.	175 °C
Diode variation	Common cathode
E _{AS}	1 mJ

DESCRIPTION

The VS-40CTQ... center tap Schottky rectifier has been optimized for very low forward voltage drop, with moderate leakage. The proprietary barrier technology allows for reliable operation up to 175 °C junction temperature. Typical applications are in switching power supplies, converters, freewheeling diodes, and reverse battery protection.

MAJOR RATINGS AND CHARACTERISTICS

SYMBOL	CHARACTERISTICS	VALUES	UNITS
I _{F(AV)}	Rectangular waveform	40	A
V _R		150	V
I _{FSM}	t _p = 5 μs sine	1500	A
V _F	20 Apk, T _J = 125 °C (per leg)	0.71	V
T _J		- 55 to 175	°C

VOLTAGE RATINGS

PARAMETER	SYMBOL	VS-40CTQ150SPbF VS-40CTQ150-1PbF	UNITS
Maximum DC reverse voltage	V _R	150	V
Maximum working peak reverse voltage	V _{RWM}		

VS-40CTQ150SPbF, VS-40CTQ150-1PbF



Vishay Semiconductors

Schottky Rectifier, 2 x 20 A

ABSOLUTE MAXIMUM RATINGS						
PARAMETER	SYMBOL	TEST CONDITIONS		VALUES	UNITS	
Maximum average forward current See fig. 5	per leg per device	$I_{F(AV)}$	50 % duty cycle at $T_C = 140\text{ }^\circ\text{C}$, rectangular waveform		20	A
					40	
Maximum peak one cycle non-repetitive surge current per leg See fig. 7		I_{FSM}	5 μs sine or 3 μs rect. pulse	Following any rated load condition and with rated V_{RRM} applied	1500	
			10 ms sine or 6 ms rect. pulse		250	
Non-repetitive avalanche energy per leg		E_{AS}	$T_J = 25\text{ }^\circ\text{C}$, $I_{AS} = 1.5\text{ A}$, $L = 0.9\text{ mH}$		1.0	mJ
Repetitive avalanche current per leg		I_{AR}	Current decaying linearly to zero in 1 μs Frequency limited by T_J maximum $V_A = 1.5 \times V_R$ typical		1.5	A

ELECTRICAL SPECIFICATIONS					
PARAMETER	SYMBOL	TEST CONDITIONS		VALUES	UNITS
Maximum forward voltage drop per leg See fig. 1	$V_{FM}^{(1)}$	20 A	$T_J = 25\text{ }^\circ\text{C}$	0.93	V
		40 A		1.16	
		20 A	$T_J = 125\text{ }^\circ\text{C}$	0.71	
		40 A		0.85	
Maximum reverse leakage current per leg See fig. 2	$I_{RM}^{(1)}$	$T_J = 25\text{ }^\circ\text{C}$	$V_R = \text{Rated } V_R$	50	μA
		$T_J = 125\text{ }^\circ\text{C}$		15	mA
Maximum junction capacitance per leg		C_T	$V_R = 5\text{ }V_{DC}$ (test signal range 100 kHz to 1 MHz), $25\text{ }^\circ\text{C}$	450	pF
Typical series inductance per leg		L_S	Measured lead to lead 5 mm from package body	8.0	nH
Maximum voltage rate of change		dV/dt	Rated V_R	10 000	V/ μs

Note

(1) Pulse width < 300 μs , duty cycle < 2 %

THERMAL - MECHANICAL SPECIFICATIONS					
PARAMETER	SYMBOL	TEST CONDITIONS		VALUES	UNITS
Maximum junction and storage temperature range		T_J, T_{Stg}		- 55 to 175	$^\circ\text{C}$
Maximum thermal resistance, junction to case per leg	R_{thJC}	DC operation See fig. 4		1.5	$^\circ\text{C/W}$
Maximum thermal resistance, junction to case per package		DC operation		0.75	
Typical thermal resistance, case to heatsink	R_{thCS}	Mounting surface, smooth and greased		0.5	
Approximate weight				2	g
				0.07	oz.
Mounting torque	minimum maximum		Non-lubricated threads	6 (5)	kgf · cm (lbf · in)
				12 (10)	
Marking device			Case style D ² PAK	40CTQ150S	
			Case style TO-262	40CTQ150-1	

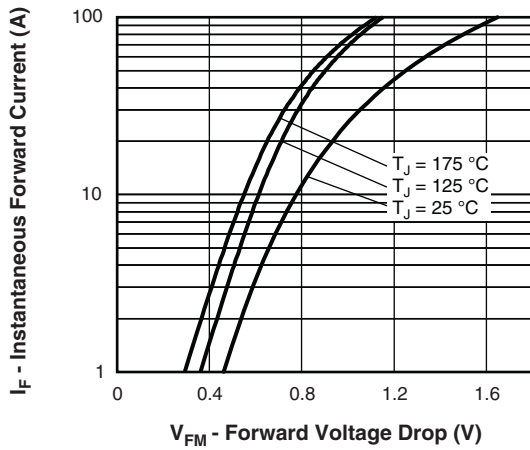

Fig. 1 - Maximum Forward Voltage Drop Characteristics

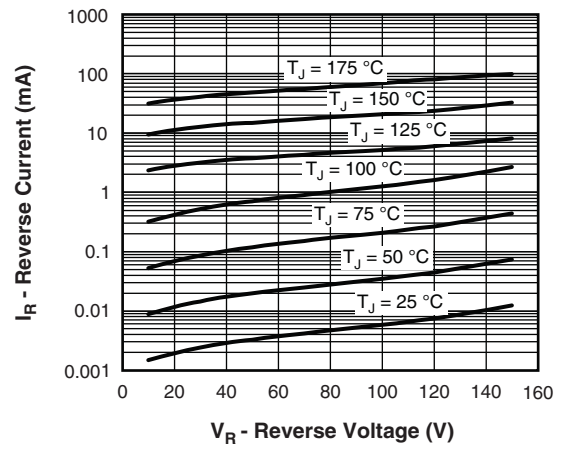

Fig. 2 - Typical Values of Reverse Current vs. Reverse Voltage

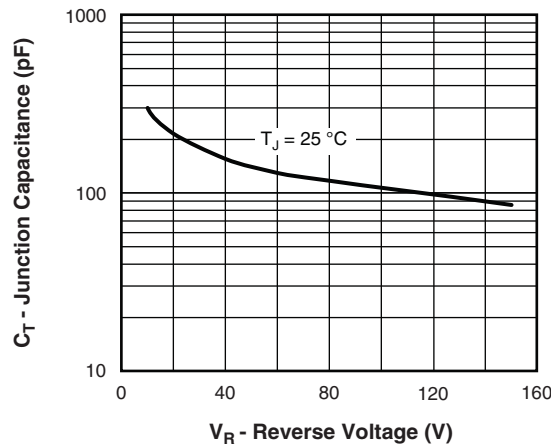

Fig. 3 - Typical Junction Capacitance vs. Reverse Voltage

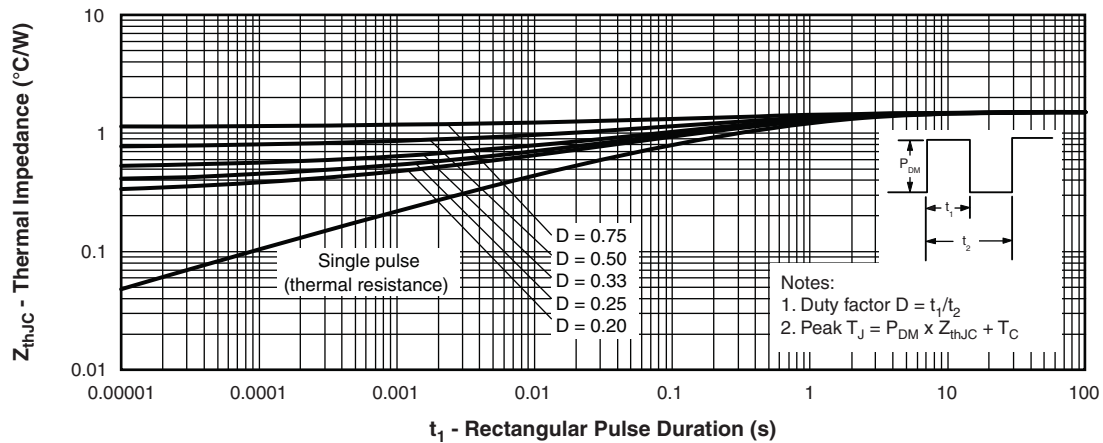

Fig. 4 - Maximum Thermal Impedance Z_{thJC} Characteristics

VS-40CTQ150SPbF, VS-40CTQ150-1PbF



Vishay Semiconductors

Schottky Rectifier, 2 x 20 A

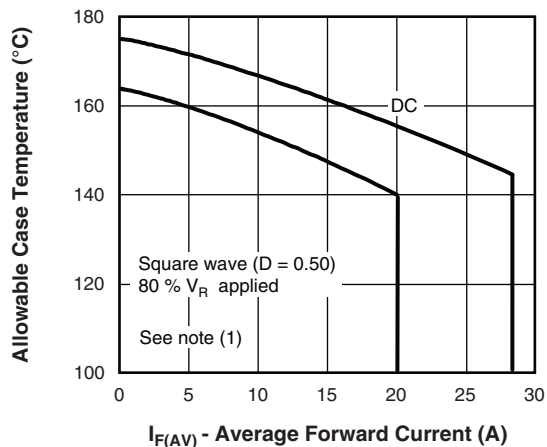

Fig. 5 - Maximum Allowable Case Temperature vs. Average Forward Current

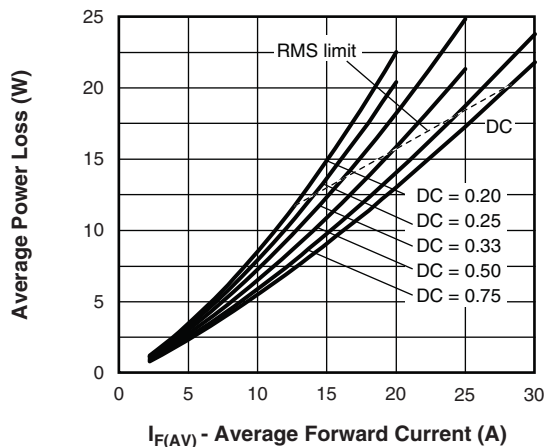

Fig. 6 - Forward Power Loss Characteristics

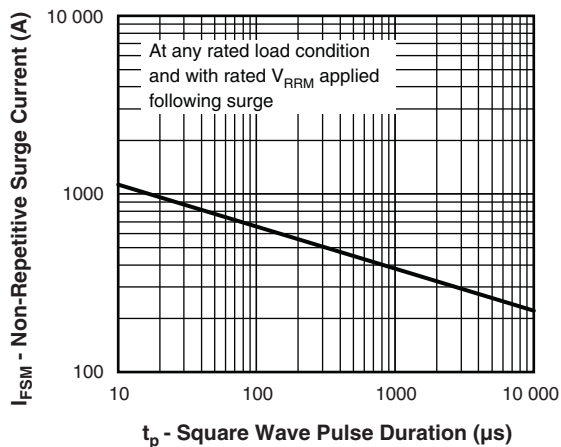

Fig. 7 - Maximum Non-Repetitive Surge Current (Per Leg)

Note

- (1) Formula used: $T_C = T_J - (P_d + P_{d_{REV}}) \times R_{thJC}$;
 P_d = Forward power loss = $I_{F(AV)} \times V_{FM}$ at $(I_{F(AV)}/D)$ (see fig. 6);
 $P_{d_{REV}}$ = Inverse power loss = $V_{R1} \times I_R (1 - D)$; I_R at $V_{R1} = 80\% V_R$ applied



VS-40CTQ150SPbF, VS-40CTQ150-1PbF

Schottky Rectifier, 2 x 20 A

Vishay Semiconductors

ORDERING INFORMATION TABLE

Device code	VS-	40	C	T	Q	150	S	TRL	PbF
	①	②	③	④	⑤	⑥	⑦	⑧	⑨

- 1** - Vishay Semiconductors product
- 2** - Current rating (40 A)
- 3** - Circuit configuration:
C = Common cathode
- 4** - T = TO-220
- 5** - Schottky "Q" series
- 6** - Voltage rating (150 = 150 V)
- 7** -
 - S = D²PAK
 - -1 = TO-262
- 8** -
 - None = Tube (50 pieces)
 - TRL = Tape and reel (left oriented - for D²PAK only)
 - TRR = Tape and reel (right oriented - for D²PAK only)
- 9** - PbF = Lead (Pb)-free

LINKS TO RELATED DOCUMENTS	
Dimensions	www.vishay.com/doc?95014
Part marking information	www.vishay.com/doc?95008
Packaging information	www.vishay.com/doc?95032
SPICE model	www.vishay.com/doc?95434

D²PAK, TO-262

DIMENSIONS - D²PAK in millimeters and inches

Conforms to JEDEC outline D²PAK (SMD-220)



SYMBOL	MILLIMETERS		INCHES		NOTES
	MIN.	MAX.	MIN.	MAX.	
A	4.06	4.83	0.160	0.190	
A1	0.00	0.254	0.000	0.010	
b	0.51	0.99	0.020	0.039	
b1	0.51	0.89	0.020	0.035	4
b2	1.14	1.78	0.045	0.070	
b3	1.14	1.73	0.045	0.068	4
c	0.38	0.74	0.015	0.029	
c1	0.38	0.58	0.015	0.023	4
c2	1.14	1.65	0.045	0.065	
D	8.51	9.65	0.335	0.380	2

SYMBOL	MILLIMETERS		INCHES		NOTES
	MIN.	MAX.	MIN.	MAX.	
D1	6.86	8.00	0.270	0.315	3
E	9.65	10.67	0.380	0.420	2, 3
E1	7.90	8.80	0.311	0.346	3
e	2.54 BSC		0.100 BSC		
H	14.61	15.88	0.575	0.625	
L	1.78	2.79	0.070	0.110	
L1	-	1.65	-	0.066	3
L2	1.27	1.78	0.050	0.070	
L3	0.25 BSC		0.010 BSC		
L4	4.78	5.28	0.188	0.208	

Notes

- (1) Dimensioning and tolerancing per ASME Y14.5 M-1994
- (2) Dimension D and E do not include mold flash. Mold flash shall not exceed 0.127 mm (0.005") per side. These dimensions are measured at the outmost extremes of the plastic body
- (3) Thermal pad contour optional within dimension E, L1, D1 and E1
- (4) Dimension b1 and c1 apply to base metal only
- (5) Datum A and B to be determined at datum plane H
- (6) Controlling dimension: inch

- (7) Outline conforms to JEDEC outline TO-263AB

DIMENSIONS - TO-262 in millimeters and inches



SYMBOL	MILLIMETERS		INCHES		NOTES
	MIN.	MAX.	MIN.	MAX.	
A	4.06	4.83	0.160	0.190	
A1	2.03	3.02	0.080	0.119	
b	0.51	0.99	0.020	0.039	
b1	0.51	0.89	0.020	0.035	4
b2	1.14	1.78	0.045	0.070	
b3	1.14	1.73	0.045	0.068	4
c	0.38	0.74	0.015	0.029	
c1	0.38	0.58	0.015	0.023	4
c2	1.14	1.65	0.045	0.065	
D	8.51	9.65	0.335	0.380	2
D1	6.86	8.00	0.270	0.315	3
E	9.65	10.67	0.380	0.420	2, 3
E1	7.90	8.80	0.311	0.346	3
e	2.54 BSC		0.100 BSC		
L	13.46	14.10	0.530	0.555	
L1	-	1.65	-	0.065	3
L2	3.56	3.71	0.140	0.146	

Notes

- (1) Dimensioning and tolerancing as per ASME Y14.5M-1994
- (2) Dimension D and E do not include mold flash. Mold flash shall not exceed 0.127 mm (0.005") per side. These dimensions are measured at the outmost extremes of the plastic body
- (3) Thermal pad contour optional within dimension E, L1, D1 and E1
- (4) Dimension b1 and c1 apply to base metal only
- (5) Controlling dimension: inches
- (6) Outline conform to JEDEC TO-262 except A1 (maximum), b (minimum) and D1 (minimum) where dimensions derived the actual package outline



Disclaimer

ALL PRODUCT, PRODUCT SPECIFICATIONS AND DATA ARE SUBJECT TO CHANGE WITHOUT NOTICE TO IMPROVE RELIABILITY, FUNCTION OR DESIGN OR OTHERWISE.

Vishay Intertechnology, Inc., its affiliates, agents, and employees, and all persons acting on its or their behalf (collectively, "Vishay"), disclaim any and all liability for any errors, inaccuracies or incompleteness contained in any datasheet or in any other disclosure relating to any product.

Vishay makes no warranty, representation or guarantee regarding the suitability of the products for any particular purpose or the continuing production of any product. To the maximum extent permitted by applicable law, Vishay disclaims (i) any and all liability arising out of the application or use of any product, (ii) any and all liability, including without limitation special, consequential or incidental damages, and (iii) any and all implied warranties, including warranties of fitness for particular purpose, non-infringement and merchantability.

Statements regarding the suitability of products for certain types of applications are based on Vishay's knowledge of typical requirements that are often placed on Vishay products in generic applications. Such statements are not binding statements about the suitability of products for a particular application. It is the customer's responsibility to validate that a particular product with the properties described in the product specification is suitable for use in a particular application. Parameters provided in datasheets and / or specifications may vary in different applications and performance may vary over time. All operating parameters, including typical parameters, must be validated for each customer application by the customer's technical experts. Product specifications do not expand or otherwise modify Vishay's terms and conditions of purchase, including but not limited to the warranty expressed therein.

Except as expressly indicated in writing, Vishay products are not designed for use in medical, life-saving, or life-sustaining applications or for any other application in which the failure of the Vishay product could result in personal injury or death. Customers using or selling Vishay products not expressly indicated for use in such applications do so at their own risk. Please contact authorized Vishay personnel to obtain written terms and conditions regarding products designed for such applications.

No license, express or implied, by estoppel or otherwise, to any intellectual property rights is granted by this document or by any conduct of Vishay. Product names and markings noted herein may be trademarks of their respective owners.

Looking for pricing, stock, or lifecycle information?

Click below to explore more details on WIN SOURCE:

 [View VS-40CTQ150-1PBF on WIN SOURCE](#)

 [Vishay Information](#)

Optimize Your Supply Chain with WIN SOURCE Solutions

-  Global Sourcing Solution
-  Obsolete Management
-  Cost Control Management
-  Shortage Management
-  Alternative Solution
-  Excess Inventory Management